

# Lacor

# 75

years next to you



# Catálogo interactivo · Interactive catalogue

## Fácil de navegar · Easy to navigate

Índice interactivo · Interactive index

Páginas interactivas · Interactive pages



## Descubre más sobre los productos · Find out more about the products

Videos demostrativos · Demonstration videos

Recetarios · Recipe book



# Sostenibilidad · Sustainability

Cambiamos nuestros embalajes para un **#futuro** más sostenible.

Llevamos mucho tiempo trabajando en una importante **#iniciativa** que estamos implementando en Lacor; un **#compromiso** que compartimos con nuestros proveedores, suministradores y clientes: la mejora de los embalajes de los productos para reducir nuestro impacto medioambiental.

Estamos eliminando los plásticos de un solo uso y utilizando embalajes más **#sostenibles** y fáciles de **#reciclar**, descartando en la medida de lo posible los materiales compuestos que no son aptos o son complicados de reciclar.

Porque cada granito de arena cuenta. ¡Seguimos mejorando!

We changed our packaging for a more sustainable **#future**.

For a long time, we've been working on an important **#initiative** that we're implementing at Lacor. It's a **#commitment** that we share with our suppliers and clients and it is to improve product packaging to reduce our environmental impact.

We're eliminating single use plastic and using packaging that is more **#sustainable** and easier to **#recycle** and eliminating composite materials that are hard to recycle or cannot be recycled as much as possible.

Because every grain of sand counts. We keep improving!



# Novedades - Novelties



Batería **COMBI**  
Battery  
« 32 / 33 »



Batería **ORIGIN**  
Battery  
« 34 / 35 »



Sartén **FOODIE**  
Frying pan  
« 37 / 101 »



Cazo **GARINOX**  
Saucepan  
« 53 »



Sartén-Grill-Wok-Crepera **EASY**  
Frying pan-Grill- Wok-Crepiera  
« 61 »



Olla a presión **GENIUS**  
Pressure Cookers  
« 75 »



Wok **FERRUM**  
Wok  
« 84 »



Wok **BASIC**  
Wok  
« 85 »



Wok **RUSTIC**  
Wok  
« 85 »



Sartén **TRICHEF**  
Fryingpan  
« 99 »



Bandeja **ESSENTIAL**  
Tray  
« 103 »



Bandeja **MASTER**  
Tray  
« 105 »



Guante **RED**  
Kitchen glove  
« 108 »



Guante **BLACK**  
Kitchen glove  
« 108 »



Paellera **TRICHEF**  
Round dish  
« 116 »



Soporte para hornear **PIZZA**  
Baking rack  
« 136 »



Pala pizza **WOOD**  
Pizza peel  
« 137 »



Cortapizza **PRO**  
Pizza cutter  
« 137 »



Espátula **TARROS**  
Spatula  
« 141 / 469 »



Espátula **EXTRAPLANA**  
Spatula  
« 141 / 469 »



Batidor **FIBREGLASS**  
Whisk  
« 143 / 467 »





Set 3 **JARRAS** medidoras  
Set 3 jar  
« 145 / 459 »



Colección **ETERN & ECOINOX**  
Collection  
« 151 »



Hervidor extensible **FLOR**  
Extendable  
« 156 »



Pinza **QUITAESPINAS**  
Fish-bone tweezers  
« 252 »



Cubitera **GLACIER**  
Ice bucket  
«280 »



Cubitera **FRESH**  
Ice bucket  
« 281 »



Prensador  
Presser  
« 164 »



Prensa **PATATAS**  
Potato press  
« 164 »



**MAZA** ablandacarnes  
Meat tenderiser  
« 165 »



Cubitera **ICE**  
Ice bucket  
«281 »



Cubitera **ICE XL**  
Ice bucket  
« 281 »



Taza **MOSCOW MULE**  
Mug  
« 292 »



**MAZA** ablandacarnes  
Meat tenderiser  
« 165 »



Prensa hamburguesa **PRO**  
Hamburger press  
« 166 »



Exprimidor manual **INOX**  
Manual juicer  
« 169 »



Pelador de piña **SLIZE**  
Pineapple peeler  
« 331 »



Cortador de patatas **ONDULADO**  
Potato cutter  
« 336 »



Mandolina vertical **PRECIS**  
Vertical mandolin  
« 343 »



Sifón **EPICURE**  
Siphon  
« 178 / 482 »



Fondue Grey **PLUS**  
Grey fondue  
« 224 / 569 »



Soporte **TACOS**  
Taco stand  
« 234 »



Cuchillo **ELITE & MASTER**  
Knife  
« 350 »



Cuchillo **CHULETERO**  
Knife  
« 353 »



Cuchillos **CORTAQUESOS**  
Cutlery knives  
« 356 »



Bandeja **CUENCOS**  
Tray bowls  
« 236 »



Bandeja **ZENSAI**  
Tray  
« 236 »



Tabla **BANBÚ & MARMOL**  
Bamboo & marble table  
« 236 »



**TACO** de cuchillos  
Knife block  
« 359 »



Afilador de cuchillos **VERTICAL**  
Knife sharpener  
« 360 »



Afilador de cuchillos **MINI**  
Knife sharpener  
« 360 »





SOPORTE para tablas  
Support for boards

<< 369 >>



Cacerolas **BUFFET**  
Pans

<<386 >>



Vajilla catering **DEGUSTARE**  
Catering crockery

<< 387 >>



Aro **CORAZÓN** perforado  
Perforated ring

<< 509 >>



Aro **HOJA** perforado  
Perforated ring

<< 509 >>



Arrocera **WHITE**  
Rice Cooker

<< 514 >>



Buffet & Display  
Buffet & Display

<< 389 >>



Bandeja **PIZARRA**  
Slate Tray

<< 390 >>



Plato **GIRATORIO**  
Turntable

<< 391 >>



Yogurtera **DEVA**  
Yoghurt maker

<< 519 >>



Freidora de aire **dAirePRO**  
Air fryer

<< 549 >>



Freidora de aire **CrystalFry**  
Air Fryer

<< 551 >>



Soporte **EXPOSITOR**  
Display Stand

<< 391 >>



Frutero **DUAL SQ**  
Fruit bowl

<< 396 >>



**LÁMPARA** extensible  
Extendable lamp

<< 407 / 577 >>



Microondas **TEMPO**  
Microwave

<< 556 >>



Grill abatible **TOTALLY**  
Folding grill

<< 563 >>



Grill abatible **CONTROLLE**  
Folding grill

<< 563 >>



Cubeta **HELADO**  
Ice bucket

<< 419 >>



Caja isométrica **TEMPLE**  
Isometric box

<< 425 >>



Rodillos **ROLLER**  
Rollers

<< 473 >>



Crepera **TITANPRO**  
Crepe maker

<< 567 >>



Picadora de **HIELO**  
Ice crusher

<< 626 >>



**PLACA** de calentamiento  
Heating plate

<< 574 / 404 >>



Set **CORTARTAS**  
Cake cutter set

<< 475 >>



Espátula para atemperar **CHOCOLATE**  
Spatula for tempering chocolate

<< 476 >>



Espátula para galletas **TASTY**  
Biscuit spatula

<< 488 >>



**20**

**Baterías profesionales**

Professional cookware

**32**

**Baterías domésticas**

Household cookware

**71**

**Ollas a presión**

Pressure cookers

**80**

**Sartenes**

Frypans

**103**

**Rustideras · Horno**

Roasting pans · Oven

**115**

**Paelleras**

Paella pans

**01**

**Menaje**  
Cookware

**122**

**Juegos de cocina**

Kitchen tools

**133**

**Preparación**

Food processing

**183**

**Básculas · Termómetros**

Scales · Thermometers

**02**

**Utensilios**  
Utensils

**192**

**Bandejas · Fuentes**

Thermos · Bottles

**198**

**Melamina**

Melamine

**215**

**Servicio Mesa**

Table service

**248**

**Pinzas**

Tongs

**256**

**Cafetería**

Coffee

**272**

**Termos · Botellas**

Thermos · Bottles

**279**

**Bar · Bodega**

Wine cellar

**306**

**Portamenú**

Portamenu

**03**

**Mesa**  
Table Top

**328**

**Corte**

Cutting

**04**

**Corte**  
Cutting

**374**

**Chafing dish + Buffet**

Chafing dish + Buffet

**05**

**Buffet**  
Buffet

**414**

**Cubetas**

Container

**425**

**Transporte · Estanterías**

Transport · Shelves

**444**

**Cestas**

Racks

**448**

**Limpieza**

Cleaning

**06**

**Gastronorm**  
Gastronorm

**458**

**Preparación repostería**

Pastry processing

**492**

**Moldes · Aros**

Moulds · Rings

**07**

**Repostería**  
Pastry

**512**

**Eléctrico**

Electric

**08**

**Eléctrico**  
Electric

# 1949-2024

1949

En 1949, Marcos Larrañaga Chinchurreta fundó la empresa "Manufacturas Metálicas Marcos Larrañaga" en un pequeño local del centro de Bergara.

In 1949, Marcos Larrañaga Chinchurreta founded the company Manufacturas Metálicas Marcos Larrañaga in small premises in the centre of Bergara.



1950

Comenzamos a fabricar en aluminio los artículos para uso doméstico y material de ortodoncia para empresas de la comarca del Alto Deba en Gipuzkoa.

We started manufacturing aluminium household items and orthodontic materials for companies in the Alto Deba region in Gipuzkoa.

1960

Trasladamos y ampliamos las instalaciones para poder fabricar menaje de aluminio para el sector de la hostelería y, posteriormente, comenzamos a fabricar las primeras piezas de acero inoxidable para el hogar. Asimismo, decidimos crear la marca comercializadora "Lacor" en honor al matrimonio que formaban el fundador Marcos Larrañaga y su mujer Casimira Cortabarría.

We moved and expanded our facilities in order to manufacture aluminium kitchenware for the hotel and catering industry and then started to manufacture the first stainless steel household articles. We also decided to create the brand name "Lacor" in honour of the married couple formed by the founder, Marcos Larrañaga, and his wife, Casimira Cortabarría.



1970

Mejoramos las piezas de acero inoxidable incluyendo el fondo difusor, además de ampliar la gama para el sector profesional. Comenzamos a exportar nuestros productos a los países contiguos Francia y Portugal.

We improved the stainless steel items by including a heat-diffusing bottom, as well as extending the professional kitchenware range. We started exporting our products to the neighbouring countries of France and Portugal.



1980

Nos convertimos en el primer fabricante nacional de menaje en grandes dimensiones de acero inoxidable con fondo difusor y de una sola pieza. Así, tuvimos que volver a trasladar y ampliar las instalaciones actuales de Bergara, además de automatizar la producción.

Seguimos trabajando para ampliar el catálogo profesional y conseguimos expandir las ventas a los 5 continentes.

We became the first national manufacturer of large single piece stainless steel kitchenware featuring a heat-diffusing bottom, so we had to relocate and expand the current facilities in Bergara, as well as automate production.

We continuously strived to expand our professional portfolio and managed to increase sales to 5 continents.



2000

Creamos la empresa "Logística del Menaje" en Alegría-Dulantzi (10.000 m2) con su posterior ampliación hasta los 30.000 m2 para almacenar y gestionar los centenares de pedidos diarios de nuestros clientes.

Igualmente, invertimos en las automatizaciones y robotizaciones en la producción para optimizar los recursos y mejorar el acabado de las piezas.

We created the company Logística del Menaje in Alegría-Dulantzi (10,000m2), followed by a subsequent extension to 30,000 m2 to store and manage the hundreds of daily orders from our customers.

We also invested in production automation and robotisation to optimise resources and improve finishing of parts



2024...

Nos consolidamos como marca líder de menaje profesional para hostelería y restauración.

Nuestros productos se caracterizan por el diseño, la calidad y la durabilidad, atributos que día a día conquistan a grandes chefs de todo el mundo.

Tratamos de contribuir a una sociedad saludable y sostenible. Promovemos el aprendizaje y el desarrollo de hábitos de vida saludables incorporando al catálogo materiales seguros y libre de tóxicos.

We have now consolidated our position as a leading brand in professional kitchenware for the hotel and catering industry.

Our products are well-known for their design, quality and durability, features that convince top chefs from all over the world on a daily basis.

We do our best to contribute to a healthy, sustainable society and promote learning and the development of a healthy lifestyle by including safe, toxic-free materials in our catalogue.



# Nuestros valores • Nos valeurs • Our values

**L**iderazgo

Leadership

Leadership

Somos una marca referencia dentro del sector de la hostelería y menaje doméstico. Tras años de esfuerzo nos hemos ganado una posición de liderazgo y nos hemos convertido en un referente en el sector.

Nous sommes une marque de référence dans le secteur de l'hôtellerie et des ustensiles de cuisine. Après des années d'efforts, nous avons acquis une position de leadership et sommes devenus une référence dans le secteur.

We're a leading brand in the hospitality and home kitchenware industries. After years of effort we've earned a leadership position and we're at the forefront of the sector.

**A**mbición

Ambition

Ambition

Estamos presentes en 90 países a lo largo de los 5 continentes. A través del esfuerzo de nuestros distribuidores, hemos conseguido llegar a las cocinas profesionales y hogares de todo el mundo.

Nous sommes présents dans 90 pays situés sur 5 continents. Grâce à l'effort de nos distributeurs, nous sommes parvenus à rentrer dans les cuisines professionnelles et les foyers du monde entier.

We're present in 90 countries on 5 continents. Through the effort of our distributors we've been able to reach homes and professional kitchens around the world.

**C**ompromiso

Engagement

Commitment

Integramos la cultura de la calidad tanto en los procesos de fabricación y productos como en la relación con nuestros clientes y colaboradores.

Nous intégrons la culture de la qualité aussi bien dans les processus de fabrication et les produits que dans la relation avec nos clients et nos collaborateurs.

We have assimilated the culture of quality in both our manufacturing processes and products and our relationships with clients and collaborators.

**O**rganización

Organisation

Organization

Pertenecemos a una tierra de profundas raíces gastronómicas donde nuestros artesanos comenzaron a fabricar las primeras cacerolas hace 75 años. Hoy en día mantenemos el mismo espíritu y pasión por nuestra propia historia.

Nous sommes issus d'une région possédant de profondes racines gastronomiques où nos artisans ont commencé à fabriquer les premières casseroles il y 75 ans. Aujourd'hui, nous avons gardé le même état d'esprit et la même passion pour notre propre histoire.

We belong to a land with deep gastronomic roots where our artisans began to make the first casseroles 75 years ago. Today, we still have the same spirit and passion for our history.

**R**esponsabilidad

Responsabilité

Responsibility

Contamos con un equipo cualificado de personas con un alto grado de responsabilidad hacia el servicio. Gracias a la dedicación diaria, hemos conseguido establecer relaciones duraderas y de confianza con nuestros clientes.

Nous bénéficions d'une équipe de personnes qualifiées avec un haut niveau de responsabilité vis-à-vis du service. Grâce à leur dévouement quotidien, nous avons pu établir des relations durables et de confiance avec nos clients.

We have a qualified team of people with a high degree of responsibility towards service. Thanks to our day in day out dedication, we've been able to build long lasting and trusting relationships with our clients.





# Conócenos · Connais-nous · Know us

## Fábrica

Usine · Factory

· **Fábrica ubicada en Bergara (España)**

· Usine située en Bergara (Espagne)

· Factory located in Bergara (Spain)



## Almacén

Entrepôt · Warehouse

· **Almacén de 30.000 m2**  
· **Capacidad: 42.000 pallets**

· Entrepôt de 30.000 m2  
· Capacité: 42.000 pallets

· Warehouse 30.000 m2  
· Capacity: 42.000 pallets



## Distribuidores

Distributeurs · Distributors

· **Más de 3200 distribuidores**  
· **Presentes en 90 países**

· Plus de 3200 distributeurs  
· Présent dans 90 pays

· More than 3200 distributors  
· Present in 90 countries



# Lacor Worldwide

## Europe

Andorra · Austria · Belgium · Bulgaria · Czech Republic · Croatia · Cyprus · Denmark · Finland · France · Germany · Greece · Holland · Hungary · Iceland · Ireland · Italy · Latvia · Lithuania · Luxembourg · Macedonia · Montenegro · Poland · Portugal · Romania · Russia · Serbia · Slovenia · Spain · Sweden · Switzerland · Turkey · UK+ · N. Ireland · Ukraine

## America

Argentina · Bolivia · Brazil · Canada · Chile · Colombia · Costa Rica · Cuba · Dominican Rep. · French Guayana · Guadalupe · Guatemala · Honduras · Jamaica · Martinique · Mexico · Paraguay · Peru · United States · Uruguay

## Asia

Azerbaijan · Cambodia · China · Hong Kong · India · Indonesia · Iran · Iraq · Israel · Japan · Jordan · Kazakhstan · Kuwait · Lebanon · Macau · Malaysia · Philippines · Qatar · Russia · Saudi Arabia · Singapore · South Korea · Sri Lanka · Taiwan · Thailand · UAE · Vietnam

## Africa

Algeria · Burkina Faso · Cape Verde · Egypt · Ethiopia · Ivory Coast · Kenya · Libya · Mauricio · Morocco · Reunion Island · Senegal · Seychelles · South Africa · Tunisia

## Oceania

Australia · New Zealand

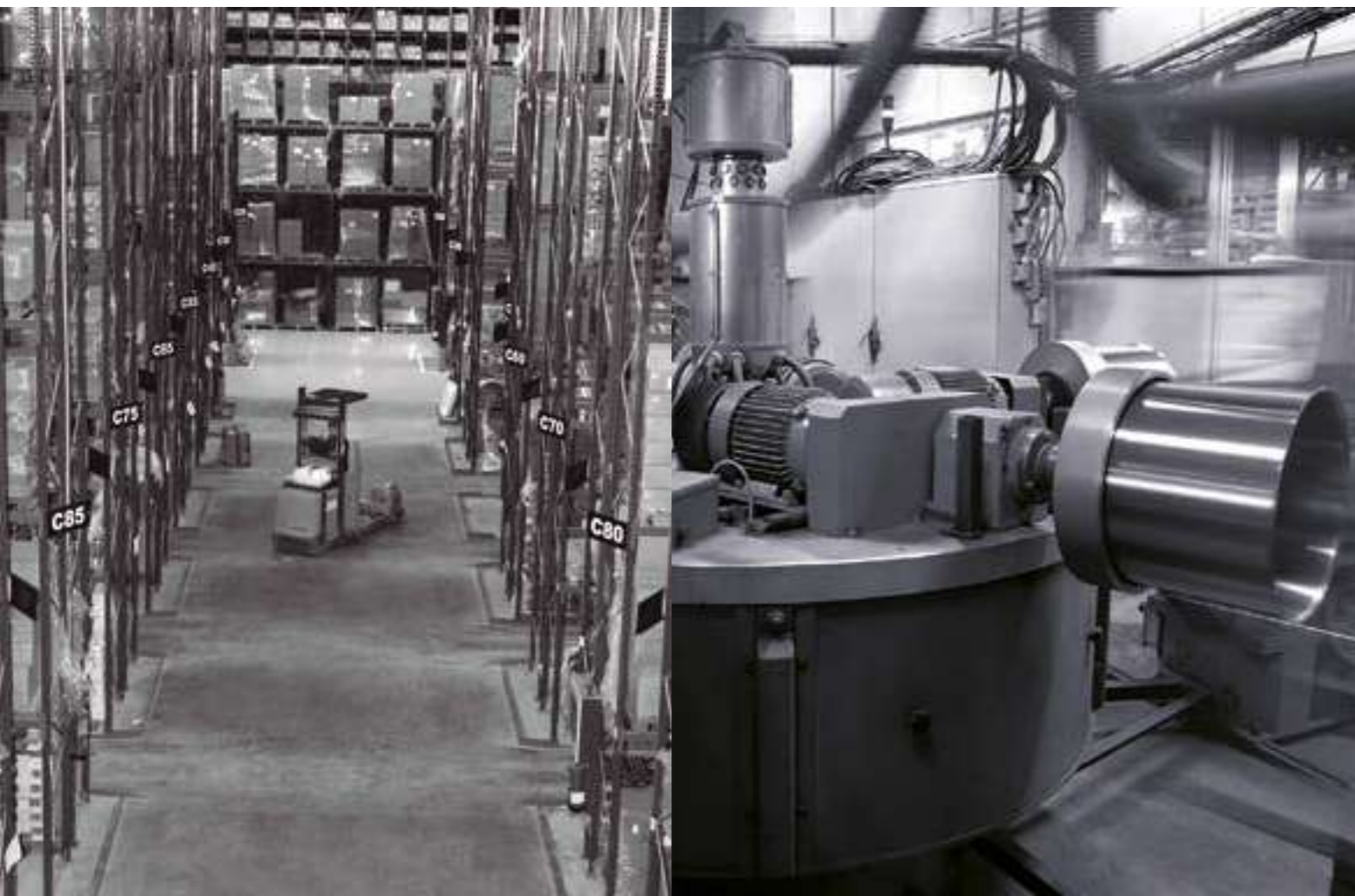

# 01

Menaje  
Cookware



# CHEF-LUXE

## Batería



ES

- Toda la pieza (cuerpo, asas y mangos) fabricada en acero inoxidable 18/10.
- Fondo termodifusor (inox 18/10 - aluminio - inox).
- Espesor 1,5 - 2 mm.
- Tapas diseñadas para el ahorro energético.
- Máxima garantía en cuanto a resistencia, durabilidad e higiene.
- Apta para todos los tipos de cocina (incluida inducción y horno).

FR

- Toute la pièce (corps, poignées et manches) est fabriquée en acier inoxydable 18/10.
- Fond thermo-diffuseur (Inox 18/10 - Aluminium - Inox).
- Épaisseur 1,5 - 2 mm.
- Couvercles conçus pour une économie d'énergie.
- Garantie maximale en termes de résistance, de durabilité et d'hygiène.
- Compatible avec tous les types de cuisinières (y compris induction et four).

EN

- The whole product (body, handles and grips) is made in 18/10 stainless steel.
- Heat diffuser bottom (18/10 stainless steel - Aluminium - Stainless).
- Thickness 1.5 - 2 mm.
- Covers designed for saving energy.
- Maximum guarantee in terms of resistance, durability and hygiene.
- Suitable for all types of cooking surfaces (including induction and the oven).



### Cacerola con tapa

Faitout avec couvercle · Bratentopf mit Deckel  
Casserole with lid · Caçarola com tampa

Ref	€	Ø (cm)	h (cm)	e (mm)	L	U.Venta
54020	83,50	20	10,0	1,5	2,90	1
54024	100,00	24	11,0	1,5	4,25	1
54028	116,00	28	11,0	1,5	6,70	1
54032	144,30	32	12,5	1,5	10,00	1
54036	175,30	36	14,0	1,5	14,20	1
54040	226,60	40	15,5	2,0	19,40	1
54045	269,40	45	17,0	2,0	27,00	1
* 54050	337,80	50	20,0	2,0	38,20	1

\* NO inducción · NON induction · NOT induction



### Cacerola sin tapa

Faitout sans couvercle · Bratentopf ohne Deckel  
Casserole without lid · Caçarola sem tampa

Ref	€	Ø (cm)	U.Venta
54020S	65,90	20	1
54024S	79,80	24	1
54028S	93,00	28	1
54032S	116,30	32	1
54036S	141,10	36	1
54040S	188,60	40	1
54045S	225,80	45	1
* 54050S	286,10	50	1

\* NO inducción · NON induction · NOT induction

### Cacerola alta con tapa

Braisière avec couvercle · Fleischtopf mit Deckel  
Deep casserole with lid · Caçarola alta com tampa

Ref	€	Ø (cm)	h (cm)	e (mm)	L	U.Venta
54021	87,30	20	13,0	1,5	4,00	1
54025	108,50	24	14,0	1,5	6,70	1
54029	132,00	28	17,5	1,5	10,70	1
54033	154,40	32	18,0	1,5	14,60	1
54037	197,00	36	21,5	1,5	21,80	1
54041	255,90	40	24,5	2,0	30,00	1
54046	303,60	45	27,5	2,0	43,70	1
* 54051	400,60	50	30,0	2,0	58,80	1

\* NO inducción · NON induction · NOT induction

### Cacerola alta sin tapa

Braisière sans couvercle · Fleischtopf ohne Deckel  
Deep casserole without lid · Caçarola alta sem tampa

Ref	€	Ø (cm)	U.Venta
54021S	69,60	20	1
54025S	88,40	24	1
54029S	109,20	28	1
54033S	126,30	32	1
54037S	162,90	36	1
54041S	217,90	40	1
54046S	260,00	45	1
* 54051S	348,80	50	1

\* NO inducción · NOT induction



### Olla recta con tapa

Marmite traiteur avec couvercle · Suppentopf mit Deckel  
Casserole with lid · Caçarola scom tampa

Ref	€	Ø (cm)	h (cm)	e (mm)	L	U.Venta
54120	96,70	20	20,0	1,5	6,20	1
54124	117,70	24	24,0	1,5	10,50	1
54128	142,40	28	28,0	1,5	17,20	1
54132	193,10	32	32,0	1,5	25,70	1
54136	238,50	36	36,0	1,5	36,50	1
54140	297,20	40	40,0	2,0	50,00	1
54145	380,30	45	45,0	2,0	71,50	1
* 54150	537,30	50	50,0	2,0	98,00	1

\* NO inducción · NON induction · NOT induction

### Olla recta sin tapa

Marmite traiteur s/couvercle · Suppentopf ohne Deckel  
Stock Pot without lid · Panela sem tampa

Ref	€	Ø (cm)	U.Venta
54120S	79,00	20	1
54124S	97,70	24	1
54128S	119,40	28	1
54132S	165,00	32	1
54136S	204,90	36	1
54140S	259,30	40	1
54145S	336,80	45	1
* 54150S	485,40	50	1

\* NO inducción · NOT induction



### Olla baja con tapa

Marmite basse avec couvercle · Gemüsetopf mit Deckel  
Low casserole with lid · Caçarola baixa com tampa

Ref	€	Ø (cm)	h (cm)	e (mm)	L	U.Venta
54119	90,20	20	15,0	1,5	4,70	1
54123	110,80	24	20,0	1,5	9,00	1
54127	138,60	28	22,0	1,5	13,50	1
54131	181,50	32	26,0	1,5	20,00	1
54135	204,10	36	29,0	1,5	29,50	1
54139	278,30	40	32,0	2,0	40,00	1

### Olla baja sin tapa

Marmite basse s/couvercle · Gemüsetopf ohne Deckel  
Low stock pot without lid · Panela baixa sem tampa

Ref	€	Ø (cm)	U.Venta
54119S	73,40	20	1
54123S	90,60	24	1
54127S	115,50	28	1
54131S	153,30	32	1
54135S	170,10	36	1
54139S	240,20	40	1



### Tartera con tapa

Plat rond avec couvercle · Pfanne mit Deckel  
Round dish with lid · Paelheira com tampa

Ref	€	Ø (cm)	h (cm)	e (mm)	L	U.Venta
54636	169,50	36	7,0	1,5	7,00	1
54640	206,30	40	8,0	1,5	10,00	1
54645	238,90	45	8,5	2,0	12,00	1
* 54650	301,50	50	9,0	2,0	17,00	1

\* NO inducción · NON induction · NOT induction

### Tartera sin tapa

Plat rond s/couvercle · Pfanne ohne Deckel  
Round dish without lid · Paelheira sem tampa

Ref	€	Ø (cm)	U.Venta
54636S	134,10	36	1
54640S	166,30	40	1
54645S	193,00	45	1
* 54650S	246,80	50	1





### Cazo recto

Casserole · Stielkasserolle, flach  
Saucepan · Caçarola direita

Ref	€	Ø (cm)	h (cm)	e (mm)	L	U.Venta
54212	43,00	12	7,0	1,2	0,75	1
54214	45,50	14	7,5	1,2	1,10	1
54216	48,10	16	8,0	1,5	1,60	1
54218	52,70	18	9,0	1,5	2,25	1
54220	59,10	20	10,0	1,5	2,90	1
* 54224	77,80	24	10,0	1,5	4,25	1
* 54228	89,90	28	11,0	1,5	6,70	1

\* Con asa · Avec poignée · With handle



### Cazo Francés

Casserole Française · Stielkasserolle, französisch  
French saucepan · Francés caçarola direita

Ref	€	Ø (cm)	h (cm)	e (mm)	L	U.Venta
54225N	76,30	24	12,0	1,5	5,40	1
54229N	97,90	28	14,0	1,5	8,60	1



### Sautex

Sauteuse · Sauteuse  
Sauteuse · Frigideira

Ref	€	Ø (cm)	h (cm)	e (mm)	L	U.Venta
* 54621	57,40	20	6,5	1,5	1,80	1
54625	69,60	24	6,5	1,5	2,70	1
54629	85,60	28	7,0	1,5	4,00	1
54633	107,20	32	8,5	1,5	4,70	1
54637	129,20	36	10,0	1,5	7,00	1

\* Sin asa · Sans poignée · Without handle



### Cazo recto alto

Casserole haute · Stielkasserolle  
Deep saucepan · Caçarola alta direita

Ref	€	Ø (cm)	h (cm)	e (mm)	L	U.Venta
54217	50,60	16	11,0	1,5	2,20	1
54219	59,20	18	12,0	1,5	3,00	1
54221	62,40	20	13,0	1,5	4,00	1
* 54225	89,10	24	14,0	1,5	6,70	1
* 54229	104,90	28	17,5	1,5	10,70	1

\* Con asa · Avec poignée · With handle



### Cazo cónico

Sautase conique · Sauteuse, Konisch  
Conical saute pan · Caçarola cónica

Ref	€	Ø (cm)	h (cm)	e (mm)	L	U.Venta
55216	48,10	16	6,0	1,5	1,00	1
55220	53,10	20	6,5	1,5	1,60	1
55224	62,10	24	7,5	1,5	2,70	1



### Tapa

Couvercle · Deckel  
Lid · Tampa

Ref	€	Ø (cm)	U.Venta
54916	16,10	16	1
54920	17,40	20	1
54924	20,00	24	1
54928	22,70	28	1
54932	27,80	32	1
54936	33,70	36	1
54940	38,00	40	1
54945	43,60	45	1
54950	51,80	50	1

# CHEF-CLASSIC

## Batería



### ES

- Toda la pieza (cuerpo, asas y mangos) fabricada en acero inoxidable 18/10.
- Fondo termodifusor (inox 18/10 - aluminio - inox).
- Espesor 0,7 - 1,2 mm.
- Tapas diseñadas para el ahorro energético.
- Apta para todos los tipos de cocina (incluida inducción y horno). \* Excepto Ø60 cm.
- Acabado mate interior y exterior.
- Máxima garantía en cuanto a resistencia, durabilidad e higiene.

### FR

- Toute la pièce (corps, poignées et manches) est fabriquée en acier inoxydable 18/10.
- Fond thermo-diffuseur (Inox 18/10 - Aluminium - Inox).
- Épaisseur 0,7 - 1,2 mm.
- Couverts conçus pour une économie d'énergie.
- Compatible avec tous les types de cuisinières (y compris induction et four). \* Excepté Ø60 cm.
- Finition mate intérieur et extérieur.
- Garantie maximale en termes de résistance, de durabilité et d'hygiène.

### EN

- The whole product (body, handles and grips) is made in 18/10 stainless steel.
- Heat diffuser bottom (18/10 stainless steel - Aluminium - Stainless).
- Thickness 0.7 - 1.2 mm.
- Covers designed for saving energy.
- Suitable for all types of cooking surfaces (including induction and the oven). \* Except Ø60 cm.
- Interior and exterior matte finish.
- Maximum guarantee in terms of resistance, durability and hygiene.



### Cacerola con tapa

Faitout avec couvercle · Bratentopf mit Deckel  
Casserole with lid · Caçarola com tampa

Ref	€	Ø (cm)	h (cm)	e (mm)	L	U.Venta
50016	49,70	16	8,0	0,7	1,60	1
50020	59,10	20	9,0	0,7	2,80	1
50024	67,10	24	9,5	0,8	4,25	1
50028	92,70	28	11,0	0,8	6,75	1
50032	116,20	32	12,5	0,8	10,00	1
50036	155,40	36	14,0	1,0	14,20	1
50040	180,20	40	15,5	1,0	19,40	1
50045	212,30	45	17,0	1,0	27,00	1
50050	294,50	50	20,0	1,0	38,20	1
* 50060	419,60	60	25,0	1,2	70,00	1

\* NO inducción · NON induction · NOT induction



### Cacerola sin tapa

Faitout sans couvercle · Bratentopf ohne Deckel  
Casserole without lid · Caçarola sem tampa

Ref	€	Ø (cm)	U.Venta
50016S	39,30	16	1
50020S	45,60	20	1
50024S	52,30	24	1
50028S	75,90	28	1
50032S	93,80	32	1
50036S	128,60	36	1
50040S	149,80	40	1
50045S	176,00	45	1
50050S	250,00	50	1
* 50060S	361,40	60	1

\* NO inducción · NOT induction



# ECO-CHEF

## Batería



Máxima garantía en resistencia y durabilidad  
Maximun guarantee in resistance and durability



### ES

- Toda la pieza (cuerpo, asas y mangos) fabricada en acero inoxidable.
- Fondo termodifusor (inox 18/10 - aluminio - inox). Espesor 0,6 - 1 mm.
- Tapas diseñadas para el ahorro energético.
- Apta para todos los tipos de cocina (incluida inducción y horno).
- Acabado interior mate y exterior brillo-mate.
- Máxima garantía en cuanto a resistencia, durabilidad e higiene.

### FR

- Toute la pièce (corps, poignées et manches) est fabriquée en acier inoxydable.
- Fond thermo-diffuseur (Inox 18/10 - Aluminium - Inox). Épaisseur 0,6 - 1 mm.
- Couverts conçus pour une économie d'énergie.
- Compatible avec tous les types de cuisinières (y compris induction et four).
- Finition mate intérieur et brillant-mate extérieur.
- Garantie maximale en termes de résistance, de durabilité et d'hygiène.

### EN

- The whole product (body, handles and grips) is made in stainless steel.
- Heat diffuser bottom (18/10 stainless steel - Aluminium - Stainless). Thickness 0.6 - 1 mm.
- Covers designed for saving energy.
- Suitable for all types of cooking surfaces (including induction and the oven).
- Interior matte finish and exterior brightness-matte finish.
- Maximum guarantee in terms of resistance, durability and hygiene.



### Cacerola sin tapa

Faitout sans couvercle · Bratentopf ohne Deckel  
Casserole without lid · Caçarola sem tampa

Ref	€	Ø (cm)	h (cm)	e (mm)	L	U.Venta
57016	28,50	16	8,0	0,6	1,60	1
57020	35,00	20	9,0	0,6	2,80	1
57024	38,30	24	9,5	0,7	4,25	1
57028	60,80	28	11,0	0,7	6,75	1
57032	72,50	32	12,5	0,7	10,00	1
57036	111,80	36	14,5	0,7	14,20	1
57040	127,30	40	15,5	0,9	19,40	1



### Cacerola alta sin tapa

Braisiere sans couvercle · Fleischtopf ohne Deckel  
Deep casserole without lid · Caçarola alta sem tampa

Ref	€	Ø (cm)	h (cm)	e (mm)	L	U.Venta
57017	30,40	16	11,0	0,6	2,20	1
57021	36,90	20	13,0	0,6	4,00	1
57025	45,20	24	15,0	0,7	7,00	1
57029	66,50	28	17,5	0,7	10,00	1
57033	80,40	32	18,0	0,7	14,40	1
57037	122,60	36	21,5	0,9	21,80	1
57041	150,40	40	24,5	0,9	30,70	1



### Olla recta sin tapa

Marmite traiteur sans couvercle · Suppentopf ohne Deckel  
Stock pot without lid · Panela sem tampa

Ref	€	Ø (cm)	h (cm)	e (mm)	L	U.Venta
57116	34,70	16	16,0	0,7	3,20	1
57120	40,60	20	20,0	0,7	6,20	1
57124	57,10	24	24,0	0,7	10,50	1
57128	84,20	28	25,5	0,9	16,50	1
57132	126,20	32	32,0	0,9	25,70	1
57136	158,50	36	36,0	0,9	36,60	1
57140	195,10	40	40,0	1,0	50,00	1



### Paellera sin tapa

Plat rond sans couvercle · Pfanne ohne Deckel  
Round without lid · Paelheira sem tampa

Ref	€	Ø (cm)	h (cm)	e (mm)	L	U.Venta
57624	37,70	24	6,5	0,7	3,00	1
57628	52,20	28	6,5	0,7	4,00	1
57632	66,70	32	7,0	0,7	5,00	1
57636	91,80	36	7,0	0,9	7,10	1
57640	105,80	40	8,0	0,9	10,00	1



### Tapa

Couvercle · Deckel  
Lid · Tampa

Ref	€	Ø (cm)	U.Venta
57916	11,00	16	1
57920	13,90	20	1
57924	15,10	24	1
57928	17,40	28	1
57932	22,50	32	1
57936	27,70	36	1
57940	31,30	40	1



### Cazo recto

Casserole · Stielkasserolle, flach  
Saucepan · Caçarola direita

Ref	€	Ø (cm)	h (cm)	e (mm)	L	U.Venta
57212	21,60	12	7,0	0,6	0,75	1
57214	23,10	14	7,5	0,6	1,10	1
57216	24,50	16	8,0	0,6	1,60	1
57218	27,00	18	8,5	0,6	2,00	1
57220	30,20	20	9,0	0,6	2,80	1
57224	38,90	24	9,5	0,7	4,25	1



### Cazo recto alto

Casserole haute · Stielkasserolle, hoch  
Deep saucepan · Caçarola alta direita

Ref	€	Ø (cm)	h (cm)	e (mm)	L	U.Venta
57217	27,00	16	11,0	0,6	2,10	1
57219	31,40	18	12,0	0,6	3,00	1
57221	35,60	20	13,0	0,6	4,00	1
57225	49,00	24	15,0	0,7	6,50	1



### Baño maría con fondo

Bahut avec fond · Bain marie Topf  
Double boiler with bottom · Banho-Maria com fundo

Ref	€	Ø (cm)	h (cm)	e (mm)	L	U.Venta
57717	31,70	16	16,0	0,7	3,20	1
57721	42,50	20	20,0	0,7	6,20	1



### Sautex

Sauteuse · Sauteuse  
Sauteuse · Frigideira

Ref	€	Ø (cm)	h (cm)	e (mm)	L	U.Venta
57625	35,60	24	6,5	0,7	2,70	1
57629	53,90	28	6,5	0,7	4,00	1

# CHEF-ALUMINIO

## Batería



**Aluminio puro (99,5%)**  
Made in pure aluminium (99,5%)

### ES

- Cuerpo fabricado en aluminio puro (99,5%).
- Asas y mangos atérmicos en tubo de acero inoxidable 18/10.
- Espesor 2,5 - 5 mm.
- Tapas diseñadas para el ahorro energético.
- Apta para todos los tipos de cocina (excepto inducción).
- Acabado mate interior y exterior mate lijado.
- Máxima garantía en cuanto a resistencia, durabilidad e higiene.

### FR

- Corps fabriqué en aluminium pur (99,5%).
- Poignées et manches athermiques en tube d'acier inoxydable 18/10.
- Épaisseur 2,5 - 5 mm.
- Couvercles conçus pour une économie d'énergie.
- Compatible avec tous les types de cuisinières (excepté l'induction).
- Finition intérieur mate et extérieur mate polie.
- Garantie maximale en termes de résistance, de durabilité et d'hygiène.

### EN

- Body made in pure (99.5%) aluminium.
- Heatproof handles and grips in a 18/10 stainless steel tube.
- Thickness 2.5 - 5 mm.
- Covers designed for saving energy.
- Suitable for all types of cooking surfaces (except induction).
- Interior matte finish and exterior sanded matte finish.
- Maximum guarantee in terms of resistance, durability and hygiene.



### Cacerola con tapa

Braisiere a/couvercle · Bratentopf mit Deckel  
Casserole with lid · Caçarola com tampa

Ref	€	Ø (cm)	h (cm)	e (mm)	L	U.Venta
20020	48,70	20	8,0	2,5	2,50	1
20024	54,30	24	9,5	2,5	4,30	1
20028	65,40	28	11,0	2,5	6,75	1
20030	70,30	30	11,5	2,5	8,15	1
20032	75,20	32	12,0	2,5	9,65	1
20034	81,70	34	13,0	3,0	11,80	1
20036	86,70	36	14,0	3,0	14,25	1
20038	97,20	38	15,0	3,0	17,00	1
20040	102,50	40	16,0	3,0	21,10	1
20045	122,40	45	18,0	3,5	28,00	1
20050	146,40	50	21,0	3,5	41,00	1
20060	208,50	60	25,0	4,5	70,00	1



### Cacerola alta con tapa

Braisiere avec couvercle · Fleischtopf mit Deckel  
Deep casserole with lid · Caçarola alta com tampa

Ref	€	Ø (cm)	h (cm)	e (mm)	L	U.Venta
20021	53,00	20	13,0	2,5	4,10	1
20025	60,80	24	15,0	2,5	6,80	1
20029	70,20	28	17,0	2,5	10,45	1
20031	76,60	30	18,0	2,5	12,70	1
20033	88,80	32	19,0	3,0	15,25	1
20035	95,70	34	21,0	3,0	18,05	1
20037	98,00	36	22,0	3,0	22,40	1
20039	106,30	38	23,0	3,0	26,10	1
20041	122,40	40	25,0	3,5	31,40	1
20046	139,90	45	28,0	4,5	45,00	1
20051	185,60	50	31,0	4,5	60,00	1
20061	246,20	60	37,0	4,5	104,00	1



### Olla recta con tapa

Marmite traiteur a/couvercle · Suppentopf mit Deckel  
Stock pot with lid · Panela com tampa

Ref	€	Ø (cm)	h (cm)	e (mm)	L	U.Venta
20120	60,30	20	20,0	2,5	6,30	1
20124	70,30	24	24,0	2,5	10,85	1
20128	88,40	28	28,0	3,0	17,25	1
20130	96,80	30	30,0	3,0	21,20	1
20132	106,50	32	32,0	3,0	25,75	1
20134	117,80	34	34,0	3,5	30,90	1
20136	126,70	36	36,0	3,5	36,65	1
20138	135,50	38	38,0	3,5	43,10	1
20140	151,90	40	40,0	4,0	50,30	1
20145	187,40	45	45,0	4,5	72,00	1
20150	211,10	50	50,0	4,5	100,00	1
20160	307,90	60	55,0	5,0	155,50	1



### Paellera

Plat rond · Pfanne  
Round · Paelheira

Ref	€	Ø (cm)	h (cm)	e (mm)	L	U.Venta
20628	41,80	28	7,0	2,5	4,30	1
20630	44,40	30	6,5	2,5	4,75	1
20632	47,50	32	7,0	2,5	5,50	1
20634	50,20	34	7,0	2,5	6,35	1
20636	53,10	36	7,5	2,5	7,45	1
20638	53,90	38	7,5	3,0	8,60	1
20640	63,40	40	8,0	3,0	10,05	1
20645	69,30	45	8,0	3,0	12,50	1
20650	80,80	50	8,0	3,0	15,50	1
20660	115,50	60	10,0	3,5	28,00	1



### Cazo recto

Casserole · Stielkasserolle, flach  
Saucepan · Caçarola direite

Ref	€	Ø (cm)	h (cm)	e (mm)	L	U.Venta
20216	27,20	16	7,0	2,5	1,40	1
20220	32,50	20	8,0	2,5	2,50	1
20224	37,00	24	9,5	2,5	4,30	1
20228	43,90	28	11,0	2,5	6,80	1



### Cazo recto alto

Casserole haute · Stielkasserolle, hoch  
Deep saucepan · Caçarola alta direite

Ref	€	Ø (cm)	h (cm)	e (mm)	L	U.Venta
20217	32,10	16	11,0	2,5	2,20	1
20221	37,30	20	13,0	2,5	4,10	1
20225	43,40	24	15,0	2,5	6,80	1
20229	50,20	28	17,0	2,5	10,50	1



### Cazo bombado

Casserole bombée · Kasserolle, Bauchig  
Rounded saucepan · Caçarola bojuda

Ref	€	Ø (cm)	h (cm)	e (mm)	L	U.Venta
21216	27,40	16	8,0	2,5	1,50	1
21220	32,80	20	10,0	2,5	2,50	1
21224	38,80	24	12,0	2,5	4,00	1
21228	45,90	28	14,0	2,5	6,50	1



### Pote cilíndrico

Pot-cilindrique · Milchtopf  
Cylindrical pot · Caneca cilíndrica

Ref	€	Ø (cm)	h (cm)	e (mm)	L	U.Venta
20716	34,50	16	16,0	2,5	3,20	1
20720	40,50	20	20,0	2,5	6,30	1



### Rustidera con asas abatibles

Plat à rotir anse tombante · Bratpfanne mit Fallgriffen  
Roaster moving handle · Assadeira com asa abatível

Ref	€	cm	h (cm)	e (mm)	L	U.Venta
20540A	53,90	40x30	6,2	2,5	7,45	1
20545A	57,80	45x32	6,2	2,5	10,40	1
20550A	72,60	50x35	7,0	3,0	12,60	1
20555A	78,80	55x37	7,7	3,0	16,30	1
20560A	84,70	60x40	7,7	3,0	18,95	1
20565A	94,80	65x43	7,9	3,0	24,30	1
20570A	100,30	70x45	9,0	3,0	28,65	1



### Rustidera con asas fijas

Plat à rotir anse fixe · Bratpfanne, m. feststehenden Griffen  
Roaster fix handle · Assadeira com asa fixa

Ref	€	cm	h (cm)	e (mm)	L	U.Venta
20540F	53,90	40x30	6,2	2,5	7,45	1
20545F	57,80	45x32	6,2	2,5	10,40	1
20550F	72,60	50x35	7,0	3,0	12,60	1
20555F	78,80	55x37	7,7	3,0	16,30	1
20560F	85,30	60x40	7,7	3,0	18,95	1
20565F	94,80	65x43	7,9	3,0	24,30	1
20570F	100,30	70x45	9,0	3,0	28,65	1



### Hervidor de pescado

Poissonnière avec grille · Fischkessel mit Einsatz  
Fish kettle with grill and lid · Peixeira

Ref	€	cm	h (cm)	e (mm)	L	U.Venta
20470	203,80	70x22	20,80	2,5	14,0	1



### Bandeja horno

Plaque à four · Backblech  
Oven tray · Bandeja forno

Ref	€	cm	h (cm)	e (mm)	U.Venta
20551	40,50	50x35	2,0	2,5	1
20561	49,40	60x40	2,0	2,5	1



### Tapa

Couvercle · Deckel  
Lid · Tampa

Ref	€	Ø (cm)	U.Venta
20920	14,50	20	1
20924	15,50	24	1
20928	18,80	28	1
20930	19,60	30	1
20932	21,70	32	1
20934	22,20	34	1
20936	23,80	36	1
20938	24,80	38	1
20940	27,60	40	1
20945	30,10	45	1
20950	35,80	50	1
20960	42,20	60	1

Baterias domésticas  
Household cookware



# COMBI Colección



New

ES

- Fabricadas en acero inoxidable 18/10 de la mejor calidad.
- Asas fabricadas en acero inoxidable con recubrimiento PVD (proceso de chapado iónico con titanio, metal de gran dureza).
- Tapa fabricada en vidrio templado con válvula de salida de vapor y aro protector de acero inoxidable con recubrimiento PVD.
- Máxima garantía en cuanto a resistencia, durabilidad e higiene.
- Marcaje de capacidades en el interior (litros).
- Fondo termodifusor sandwich (inox 18/10 - aluminio - inoxidable).
- Distribución rápida y uniforme del calor.
- Apta para todos los fuegos (incluido inducción y horno). Apta para el lavavajillas.

FR

- Fabriquées en acier inoxydable 18/10 de la meilleure qualité.
- Poignées en acier inoxydable avec revêtement PVD (procédé de placage ionique avec du titane, métal de haute dureté).
- Couvercle en verre trempé avec soupape d'évacuation de la vapeur et anneau de protection en acier inoxydable revêtu de PVD
- Garantie maximale en termes de résistance, de durabilité et d'hygiène.
- Marquage des contenances à l'intérieur (litres).
- Fond thermodifuseur sandwich (inox 18/10 - aluminium - inoxydable).
- Distribution rapide et uniforme de la chaleur.
- Apte pour tous les types de feux (y compris l'induction et le four). Aptes pour le lave-vaisselle.

EN

- Maximum guarantee in resistance, durability and hygiene.
- Handles made of stainless steel with PVD coating (ionic plating process with titanium, high hardness metal).
- Lid made of tempered glass with steam outlet valve and protective ring made of PVD-coated stainless steel
- Maximum guarantee in terms of resistance, durability and hygiene.
- Capacity markings on the inside (litres).
- Heat-diffusing sandwiched base (18/10 stainless steel - aluminium - st. Steel).
- Quick and even heat distribution.
- Suitable for all types of cookers (including induction hobs and ovens). Dishwasher safe.



**Apilables:**  
ahorra espacio de almacenamiento  
Empilables:  
elle permet de gagner de l'espace de rangement.  
Stackable: save storage space



**Sistema Click&Lock:**  
Mango y asas desmontables  
Système Click&Lock:  
Poignées et manches démontable  
Click&Lock system:  
Detachable handles and grips



**Tapa de cristal resistente a los golpes con válvula y borde de acero inoxidable 18/10**  
Couvercle en verre avec soupape résistante aux chocs et bord en acier inoxydable 18/10  
Glass cover with pressure valve resistant to bumps and 18/10 stainless steel rim



### Cuerpo para cacerola/cazo

Corps pour faitout/casserole · Körper für Bratentopf/Stielkasserolle  
Body for casserole/saucepan · Corpo para caçarola/caçarola direita

Ref	€	Ø (cm)	h (cm)	L	U.Venta
56614	21,50	14	7,0	1,00	1
56616	24,70	16	8,0	1,50	1
56618	28,50	18	9,0	2,00	1
56620	32,40	20	10,0	3,00	1
56624	43,70	24	12,0	5,50	1



### Cuerpo para tartera/sartén

Corps pour plat rond/poêle · Körper für Pfanne/Pfanne  
Body for round dish/frying pan · Corpo para tarteira/sertã

Ref	€	Ø (cm)	h (cm)	L	U.Venta
56720	23,70	20	4,0	1,00	1
56724	29,40	24	4,5	2,00	1
56728	39,90	28	5,0	3,00	1
56732	47,60	32	5,5	4,00	1



### Cuerpo para tartera/sartén

Corps pour plat rond/poêle · Körper für Pfanne/Pfanne  
Body for round dish/frying pan · Corpo para tarteira/sertã

Ref	€	Ø (cm)	h (cm)	L	U.Venta
56820	30,90	20	4,0	1,00	1
56824	37,40	24	4,5	2,00	1
56828	49,70	28	5,0	3,00	1
56832	57,70	32	5,5	4,00	1



### Tapa

Couvercle · Deckel  
Lid · Tampa

Ref	€	Ø (cm)	U.Venta
56914	16,40	14	1
56916	17,00	16	1
56918	17,80	18	1
56920	18,70	20	1
56924	20,00	24	1
56928	20,60	28	1
56932	21,50	32	1

**Asa fabricada en baquelita termoresistente**  
Poignée fabriqué en bakélite thermo-isolante  
Handle made in heat resistant bakelite



### Asa

Poignée · Griff  
Handle · Asa

Ref	€	Color	U.Venta
A 56600	13,00	Negro · Black	1
B 56604	13,30	Azul · Blue	1
C 56602	13,30	Rojo · Red	1

**Mango fabricado en baquelita termoresistente**  
Manche fabriqué en bakélite thermo-isolante  
Grip made in heat resistant bakelite



### Mango

Poignée · Griff  
Handle · Cabo

Ref	€	Color	U.Venta
A 56601	14,20	Negro · Black	1
B 56605	14,40	Azul · Blue	1
C 56603	14,40	Rojo · Red	1

# ORIGIN

## Colección



New

ES

- Fabricadas en acero inoxidable 18/10 de la mejor calidad.
- Asas fabricadas en acero inoxidable con recubrimiento PVD (proceso de chapado iónico con titanio, metal de gran dureza).
- Tapa fabricada en vidrio templado con válvula de salida de vapor y aro protector de acero inoxidable con recubrimiento PVD.
- Máxima garantía en cuanto a resistencia, durabilidad e higiene.
- Marcaje de capacidades en el interior (litros).
- Fondo termodifusor sandwich (inox 18/10 - aluminio - inoxidable).
- Distribución rápida y uniforme del calor.
- Apta para todos los fuegos (incluido inducción y horno) . Apta para el lavavajillas.

FR

- Fabriquées en acier inoxydable 18/10 de la meilleure qualité.
- Poignées en acier inoxydable avec revêtement PVD (procédé de placage ionique avec du titane, métal de haute dureté).
- Couvercle en verre trempé avec soupape d'évacuation de la vapeur et anneau de protection en acier inoxydable revêtu de PVD
- Garantie maximale en termes de résistance, de durabilité et d'hygiène.
- Marquage des contenances à l'intérieur (litres).
- Fond thermodiffuseur sandwich (inox 18/10 - aluminium - inoxydable).
- Distribution rapide et uniforme de la chaleur.
- Apte pour tous les types de feux (y compris l'induction et le four). Aptes pour le lave-vaisselle.

EN

- Maximum guarantee in resistance, durability and hygiene.
- Handles made of stainless steel with PVD coating (ionic plating process with titanium, high hardness metal).
- Lid made of tempered glass with steam outlet valve and protective ring made of PVD-coated stainless steel
- Maximum guarantee in terms of resistance, durability and hygiene.
- Capacity markings on the inside (litres).
- Heat-diffusing sandwiched base (18/10 stainless steel - aluminium - st. Steel).
- Quick and even heat distribution.
- Suitable for all types of cookers (including induction hobs and ovens). Dishwasher safe.



**Recubrimiento PVD**  
PVD coating

**Proceso de chapado iónico con titanio, metal de gran dureza**  
Ionic plating process with titanium, high hardness metal



**Tapa fabricada en vidrio templado**  
Lid made of tempered glass

**Aro protector de acero inoxidable con recubrimiento PVD**  
Protective ring made of PVD-coated stainless steel



**Distribución rápida y uniforme del calor**  
Quick and even heat distribution

**Fondo termodifusor sandwich (inox 18/10 - aluminio - inoxidable)**  
Heat-diffusing sandwiched base (18/10 stainless steel - aluminium - st. Steel).



### Cacerola con tapa

Faitout avec couvercle · Bratentopf mit Deckel  
Casserole with lid · Caçarola com tampa

Ref	€	Ø (cm)	h (cm)	L	U.Venta
47020	48,90	20	10	3,00	1
47024	57,20	24	12	5,20	1
47028	66,90	28	14	8,30	1



### Cacerola baja con tapa

Faitout bas avec couvercle · Bratentopf mit Deckel  
Low casserole with lid · Caçarola baixa com tampa

Ref	€	Ø (cm)	h (cm)	L	U.Venta
47128	61,40	28	8	4,70	1



### Cazo recto

Casserole · Stielkasserolle, flach  
Saucepan · Caçarola direite

Ref	€	Ø (cm)	h (cm)	L	U.Venta
47214	25,30	14	7	1,00	1
47216	27,70	16	8	1,50	1
47218	30,40	18	9	2,10	1
47220	34,30	20	10	3,00	1



### Tapa

Couvercle · Deckel  
Lid · Tampa

Ref	€	Ø (cm)	U.Venta
47620	15,30	20	1
47624	16,60	24	1
47628	18,40	28	1

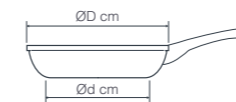

### Sartén

Poêle · Pflanne  
Frying pan · Sertã

Ref	€	ØD (cm)	Ød (cm)	h (cm)	e (mm)	U.Venta
47318	24,30	18	12,5	4,00	0,6	1
47320	27,10	20	12,8	4,20	0,6	1
47322	29,20	22	16,8	4,40	0,6	1
47324	31,10	24	18,5	4,60	0,6	1
47328	34,80	28	21,2	4,80	0,6	1
47330	37,80	30	23,0	5,00	0,6	1

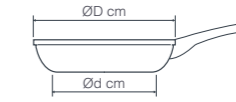

### Sartén antiadherente

Poêle antiadherent · Pflanne, Antihafit  
Frying-pan, non-stick · Sertã anti-aderente

Ref	€	ØD (cm)	Ød (cm)	h (cm)	e (mm)	U.Venta
47418	28,80	18	12,5	4,00	0,6	1
47420	31,90	20	12,8	4,20	0,6	1
47422	34,30	22	16,8	4,40	0,6	1
47424	36,50	24	18,5	4,60	0,6	1
47428	41,40	28	21,2	4,80	0,6	1
47430	45,10	30	23,0	5,00	0,6	1

# FOODIE Colección



**Marcaje de capacidades en el interior (litros)**  
Capacity markings on the inside (litres)

## ES

- Fabricadas en acero inoxidable 18/10 de la mejor calidad.
- Asas y mangos ergonómicos de acero inoxidable fundido.
- Máxima garantía en cuanto a resistencia, durabilidad e higiene.
- Acabado interior y exterior lijado satinado.
- Marcaje de capacidades en el interior (litros).
- Fondo termodifusor sandwich (inox 18/10 - aluminio - inoxidable).
- Distribución rápida y uniforme del calor.
- Aptas para todos los fuegos (incluido inducción y horno).

## FR

- Fabriquées en acier inoxydable 18/10 de la meilleure qualité.
- Poignées et manches ergonomiques en acier inoxydable fondu.
- Garantie maximale en termes de résistance, de durabilité et d'hygiène.
- Finition intérieure et extérieure en polissage satiné.
- Marquage des contenances à l'intérieur (litres).
- Fond thermodiffuseur sandwich (inox 18/10 - aluminium - inoxydable).
- Distribution rapide et uniforme de la chaleur.
- Aptes pour tous les types de feux (y compris l'induction et le four).

## EN

- Maximum guarantee in resistance, durability and hygiene.
- Ergonomic handles and grips made of cast st. steel.
- Maximum guarantee in terms of resistance, durability and hygiene.
- Glossy sanded interior and exterior finish.
- Capacity markings on the inside (litres).
- Heat-diffusing sandwiched base (18/10 stainless steel - aluminium - st. Steel).
- Quick and even heat distribution.
- Suitable for all types of cookers (including induction hobs and ovens).



### Cacerola con tapa

Faitout avec couvercle · Bratentopf mit Deckel  
Casserole with lid · Caçarola com tampa

Ref	€	Ø (cm)	h (cm)	L	U.Venta
45016	45,70	16	7,5	1,50	1
45018	49,60	18	8,5	2,00	1
45020	54,20	20	9,5	3,00	1
45022	61,60	22	10,5	4,00	1
45024	67,90	24	11,5	5,00	1
45026	75,10	26	12,5	6,50	1
45028	81,20	28	12,5	7,50	1



### Olla con tapa

Marmite avec couvercle · Fleichtopf mit Deckel  
Stock pot with lid · Panela com tampa

Ref	€	Ø (cm)	h (cm)	L	U.Venta
45116	50,30	16	13,0	2,50	1
45118	53,80	18	14,0	3,50	1
45120	60,80	20	15,5	4,80	1
45122	66,20	22	15,5	5,50	1
45124	73,70	24	16,0	7,00	1
45126	80,60	26	16,0	8,00	1
45128	91,50	28	17,0	10,00	1



### Cazo recto

Casserole · Stielkasserolle, flach  
Saucepan · Caçarola direita

Ref	€	Ø (cm)	h (cm)	L	U.Venta
45214	32,80	14	7,5	1,00	1
45216	35,30	16	7,5	1,50	1
45218	39,40	18	8,5	2,00	1
45220	44,70	20	9,5	3,00	1



### Tapa

Couvercle · Deckel  
Lid · Tampa

Ref	€	Ø (cm)	U.Venta
45916	12,30	16	1
45918	12,90	18	1
45920	13,90	20	1
45922	15,00	22	1
45924	16,50	24	1
45926	17,60	26	1
45928	19,50	28	1



### Tartera con tapa

Plat rond avec couvercle · Pfanne mit Deckel  
Round dish with lid · Tarteira com tampa

Ref	€	Ø (cm)	h (cm)	L	U.Venta
45624	62,50	24	6,5	2,80	1
45626	68,60	26	6,5	3,00	1
45628	74,20	28	6,5	4,00	1



### Sartén

Poêle · Pfanne  
Frying pan · Sertã

Ref	€	ØD (cm)	Ød (cm)	h (cm)	e (mm)	U.Venta
45420	29,60	20	13,5	5,5	0,6	1
45422	31,50	22	14,5	5,5	0,6	1
45424	35,30	24	17,5	6,0	0,6	1
45426	37,50	26	19,0	6,0	0,6	1
45428	41,50	28	19,5	6,5	0,6	1
45430	42,70	30	22,0	6,5	0,6	1



### Sartén antiadherente

Poêle antiadherent · Pfanne, Antihafit  
Frying-pan, non-stick · Sertã anti-aderente

Ref	€	ØD (cm)	Ød (cm)	h (cm)	e (mm)	U.Venta
45320	34,80	20	13,5	5,5	0,6	1
45322	36,10	22	14,5	5,5	0,6	1
45324	42,60	24	17,5	6,0	0,6	1
45326	43,70	26	19,0	6,0	0,6	1
45328	51,00	28	19,5	6,5	0,6	1
45330	52,20	30	22,0	6,5	0,6	1

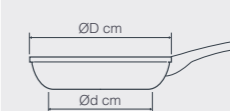

## ANTIADHERENTE

PPG QuanTanium®  
Titanium-reinforced non-stick coating

High release topcoat  
Partially reinforced midcoat  
Reinforced primer (titanium-based particles)  
Metal substrate

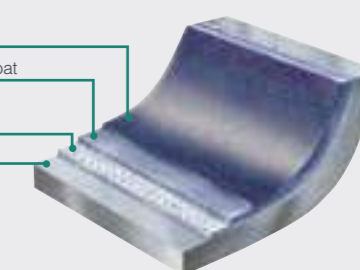

- Antiadherente QuanTanium® reforzado con partículas de titanio; libre de materiales tóxicos y pesados, ecológico y libre de PFOA.
- Antiadhésif QuanTanium® renforcé avec des particules de titane ; sans matériaux toxiques ni métaux lourds, écologique et sans PFOA.
- QuanTanium® non-stick reinforced with titanium particles; free from toxic and heavy materials, environmentally friendly and PFOA-free.

# PROFESIONAL

## Colección

Inox  
18/10



ES

- Toda la pieza (cuerpo, asas y mangos) fabricada en acero inoxidable 18/10.
- Favorece una distribución rápida y homogénea del calor.
- Acabado pulido brillante exterior y lijado mate interior.
- Máxima garantía en cuanto a resistencia, durabilidad e higiene.
- Apta para todo tipo de cocinas (incluido inducción y horno).
- Fondo termodifusor sándwich (inox 18/10 - aluminio - inox).

FR

- Toute la pièce (corps, poignées et manches) est fabriquée en acier inoxydable 18/10.
- Favorise une distribution rapide et homogène de la chaleur.
- Finition extérieure polie brillante et intérieur polie mate.
- Garantie maximale en termes de résistance, de durabilité et d'hygiène.
- Compatible avec tout type de cuisinières (y compris induction et four).
- Fond thermo-diffuseur sandwich (inox 18/10 - aluminium - inox).

EN

- The whole product (body, handles and grips) is made in 18/10 stainless steel.
- It favours quick and homogeneous heat distribution.
- Exterior glossy, polished finish and sanded matte interior.
- Maximum guarantee in terms of resistance, durability and hygiene.
- Suitable for all types of cooking surfaces (including induction and the oven).
- Sandwich heat diffuser (18/10 stainless steel - aluminium - stainless steel).



Asas y mangos ergonómicos fabricados en acero inoxidable 18/10

Handles and grips are made in 18/10 stainless steel



Acabado pulido brillante exterior y lijado mate interior

Exterior glossy, polished finish and sanded matte interior

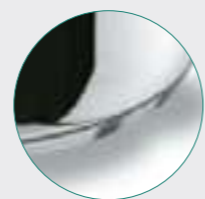

Fondo termodifusor sandwich (inox 18/10 - aluminio - inoxidable)

Heat-diffusing sandwiched base (18/10 stainless steel - aluminium - st. Steel).

### CARACTERÍSTICAS



#### Cacerola con tapa

Faitout a/couvercle · Bratentopf mit Deckel  
Casserole with lid · Caçarola com tampa

Ref	€	Ø (cm)	h (cm)	L	U.Venta
72016	51,30	16	8,0	1,50	1
72020	59,90	20	8,5	2,50	1
72024	70,10	24	9,5	3,50	1
72028	89,80	28	11,0	6,50	1
72032	121,80	32	12,5	9,00	1



#### Olla super alta con tapa

Marmite S. Haute a/couvercle · Hoher Fleischtopf mit Deckel  
Deep Stock pot with Lid · Panela super alta com tampa

Ref	€	Ø (cm)	h (cm)	L	U.Venta
72125	84,10	24	20,0	9,00	1
72129	110,10	28	22,0	13,50	1



#### Pote cilíndrico

Pot-cilindrique · Milchtopf  
Cylindrical pot · Caneca cilíndrica

Ref	€	Ø (cm)	h (cm)	L	U.Venta
72714	32,30	14	12,5	1,50	1
72716	36,50	16	13,0	2,50	1



#### Olla con tapa

Marmite a/couvercle · Fleischtopf mit Deckel  
Stock pot with Lid · Panela com tampa

Ref	€	Ø (cm)	h (cm)	L	U.Venta
72116	55,40	16	13,0	2,50	1
72120	64,00	20	14,5	4,50	1
72124	77,00	24	15,0	6,50	1
72128	100,10	28	17,0	10,00	1



#### Cazo recto

Casserole · Stielkasserole, flach  
Saucepan · Caçarola direita

Ref	€	Ø (cm)	h (cm)	L	U.Venta
72214	27,50	14	7,5	1,00	1
72216	31,10	16	8,0	1,50	1
72218	33,40	18	8,5	2,00	1
72220	37,60	20	8,5	2,50	1



#### Tapa

Couvercle · Deckel  
Lid · Tampa

Ref	€	Ø (cm)	U.Venta
72916	13,90	16	1
72918	14,60	18	1
72920	16,90	20	1
72924	19,50	24	1
72928	25,20	28	1
72932	27,30	32	1

# BELLY

## Colección



### ES

- Toda la pieza (cuerpo y asas) fabricada en acero inoxidable 18/10.
- Máxima garantía en cuanto a resistencia, durabilidad e higiene.
- El diseño de cuerpos bombeados proporciona mayor capacidad.
- Marcaje de capacidades en el interior (litros).
- Fondo termodifusor sandwich (inox 18/10 - aluminio - inoxidable).
- Distribución rápida y uniforme del calor.
- Apta para todos los fuegos (incluido inducción y horno).
- Incluye tapa de cristal resistente a los golpes con válvula y borde de acero inoxidable 18/10.

### FR

- Toute la pièce (corp et poignées) est fabriquée en acier inoxydable 18/10.
- Garantie max. en termes de résistance, de durabilité et d'hygiène.
- La forme bombée des corps confère une plus grande capacité.
- Marquage des contenances à l'intérieur (litres).
- Fond thermodiffuseur sandwich (inox 18/10 - aluminium - inoxydable).
- Distribution rapide et uniforme de la chaleur.
- Apte pour tous les types de feux (y compris l'induction et le four).
- Inclut un couvercle en verre avec soupape résistante aux chocs et bord en acier inoxydable 18/10.

### EN

- The whole product (body and handles) is made in 18/10 st. steel.
- Max. guarantee in terms of resistance, durability and hygiene.
- Its rounded body provides greater capacity.
- Capacity markings on the inside (litres).
- Heat-diffusing sandwiched base (18/10 stainless Steel - aluminium - stainless Steel).
- Quick and even heat distribution.
- Suitable for all types of cookers (including induction hobs and ovens).
- It includes a glass cover with pressure valve resistant to bumps and 18/10 stainless steel rim.



**Fondo Curvo**  
Proporciona mayor capacidad

Curved bottom  
Provides greater capacity

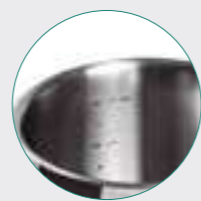

**Marcajes de capacidad**  
en litros

Capacity markings inside  
in litres



**Tapa de cristal resistente a golpes**  
con válvula y borde de acero inoxidable 18/10

Glass cover with pressure valve resistant to bumps and 18/10 stainless steel rim



### Cacerola con tapa

Faitout avec couvercle · Bratentopf mit Deckel  
Casserole with lid · Caçarola com tampa

Ref	€	Ø (cm)	h (cm)	L	U.Venta
79016	40,00	16	8,5	1,20	1
79020	54,30	20	9,5	2,50	1
79024	74,00	24	11,5	4,40	1
79028	97,20	28	15,0	8,20	1



### Olla con tapa

Marmite avec couvercle · Fleischtopf mit Deckel  
Stock pot with Lid · Panela com tampa

Ref	€	Ø (cm)	h (cm)	L	U.Venta
79116	44,70	16	10,0	1,60	1
79120	61,40	20	12,0	3,50	1
79124	78,80	24	14,0	5,50	1
79128	104,30	28	17,0	9,50	1



### Cazo recto

Casserole · Stielkasserole, flach  
Saucepan · Caçarola direite

Ref	€	Ø (cm)	h (cm)	L	U.Venta
79214	28,00	14	9,0	1,20	1
79216	32,70	16	9,5	1,60	1
79218	37,10	18	10,5	2,50	1
79220	42,80	20	11,5	3,50	1



### Cacerola vapor

Panier vapeur · Dampfkoch-Aufsatz  
Steam casserole · Caçarola a vapor

Ref	€	Ø (cm)	h (cm)	L	U.Venta
79420	34,80	20	9,5	3,00	1
79424	46,40	24	12,0	4,50	1



### Tartera con tapa

Plat rond avec couvercle · Pfanne mit Deckel  
Round dish with lid · Tarteira com tampa

Ref	€	Ø (cm)	h (cm)	L	U.Venta
79624	61,60	24	7,5	2,60	1
79628	78,30	28	7,5	3,0	1



### Pote

Pot · Milchtopf  
Pot · Caneca

Ref	€	Ø (cm)	h (cm)	L	U.Venta
79714	28,00	14	11,0	1,50	1



### Wok

Wok · Wok  
Wok · Wok

Ref	€	Ø (cm)	h (cm)	L	U.Venta
79830	62,80	30	10,0	4,50	4



### Tapa

Couvercle · Deckel  
Lid · Tampa

Ref	€	Ø (cm)	U.Venta
79916	12,80	16	1
79920	17,10	20	1
79924	21,20	24	1
79928	26,70	28	1

# VITROCOR

## Colección



ES

- Toda la pieza (cuerpo, asas y mangos) fabricada en acero inoxidable 18/10.
- Favorece una distribución rápida y homogénea del calor.
- Destaca por su diseño clásico, funcionalidad y sencillez.
- Acabado pulido brillante exterior y lijado mate interior.
- Apta para todo tipo de cocinas (incluido inducción y horno).
- Fondo termodifusor sandwich (inox 18/10 - aluminio - inox).
- Apta para el lavavajillas.

FR

- Toute la pièce (corps, poignées et manches) est fabriquée en acier inoxydable 18/10.
- Favorise une distribution rapide et homogène de la chaleur.
- Se distingue par son style classique, sa fonctionnalité et sa simplicité.
- Finition extérieure polie brillante et intérieur limage mat.
- Compatible avec tout type de cuisinières (y compris induction et four).
- Fond thermo-diffuseur sandwich (inox 18/10 - aluminium - inox).
- Apte pour le lave-vaisselle.

EN

- The whole product (body, handles and grips) is made in 18/10 stainless steel.
- It favours quick and homogeneous heat distribution.
- Stands out for its classic design, functionality and simplicity.
- Exterior glossy, polished finish and sanded matte interior.
- Suitable for all types of cooking surfaces (including induction and the oven).
- Sandwich heat diffuser (18/10 stainless steel - aluminium - stainless steel).
- Dishwasher safe.



### Cacerola con tapa

Faitout avec couvercle · Bratentopf mit Deckel  
Casserole with lid · Caçarola com tampa

Ref	€	Ø (cm)	h (cm)	L	U.Venta
40016	39,20	16	8,0	1,50	1
40018	42,70	18	8,5	2,00	1
40020	47,20	20	8,5	2,50	1
40022	51,80	22	9,0	3,00	1
40024	55,40	24	9,5	3,50	1
40026	62,80	26	9,5	4,50	1
40028	80,40	28	11,0	6,50	1
40032	101,30	32	12,5	9,50	1
40036	137,80	36	14,0	14,20	1
40040	159,90	40	15,5	19,50	1



### Olla con tapa

Marmite avec couvercle · Fleischtopf mit Deckel  
Stock pot with Lid · Panela com tampa

Ref	€	Ø (cm)	h (cm)	L	U.Venta
40116	44,10	16	13,0	2,50	1
40118	47,10	18	14,0	3,50	1
40120	51,40	20	14,5	4,50	1
40122	57,00	22	14,5	5,50	1
40124	64,00	24	15,0	6,50	1
40126	69,60	26	15,0	7,50	1
40128	88,00	28	17,0	10,00	1
40132	106,30	32	17,5	13,50	1
40136	150,70	36	21,5	22,00	1
40140	183,70	40	24,5	30,80	1



### Olla super alta con tapa

Marmite S. Haute a/couvercle · Hoher Fleischtopf mit Deckel  
Deep Stock pot with Lid · Panela super alta com tampa

Ref	€	Ø (cm)	h (cm)	L	U.Venta
40121	56,20	20	17,5	5,50	1
40125	73,10	24	20,0	9,00	1
40129	98,00	28	22,0	13,50	1
40133	145,10	32	28,0	22,50	1



### Cacerola vapor

Panier vapeur · Dampfkoch-Aufsatz  
Steam casserole · Caçarola a vapor

Ref	€	Ø (cm)	h (cm)	L	U.Venta
40420	35,00	20	8,5	2,50	1
40424	44,10	24	9,5	3,50	1
40428	48,40	28	11,0	6,50	1



### Pote cilíndrico

Pot-cilindrique · Milchtopf  
Cylindrical pot · Caneca cilíndrica

Ref	€	Ø (cm)	h (cm)	L	U.Venta
40712	29,00	12	12,0	1,00	1
40714	31,00	14	12,5	1,50	1
40716	34,10	16	13,0	2,50	1
40718	37,70	18	14,0	3,50	1



### Tapa

Couvercle · Deckel  
Lid · Tampa

Ref	€	Ø (cm)	U.Venta
40916	10,60	16	1
40918	10,80	18	1
40920	11,40	20	1
40922	12,10	22	1
40924	13,30	24	1
40926	14,20	26	1
40928	17,90	28	1
40932	22,40	32	1
40936	30,00	36	1
40940	34,10	40	1



### Escurridera · Colador esférico

Passoire sur pied · Abtropfschüssel  
Colander with stand · Escorredor

Ref	€	Ø (cm)	h (cm)	U.Venta
40318	31,30	19	8,5	1
40324	48,90	24	11,0	1



### Cazo recto

Casserole · Stielkasserole, flach  
Saucepan · Caçarola direita

Ref	€	Ø (cm)	h (cm)	L	U.Venta
40212	24,60	12	7,0	0,80	1
40214	25,50	14	7,5	1,00	1
40216	28,90	16	8,0	1,50	1
40218	31,50	18	8,5	2,00	1
40220	36,60	20	8,5	2,50	1



### Tartera con tapa

Plat rond avec couvercle · Pfanne mit Deckel  
Round dish with lid · Tarteira com tampa

Ref	€	Ø (cm)	h (cm)	L	U.Venta
40620	47,10	20	6,5	2,00	1
40622	50,10	22	6,5	2,50	1
40624	55,20	24	7,0	3,00	1
40626	59,80	26	7,0	3,50	1
40628	74,60	28	8,0	4,50	1
40632	90,50	32	8,0	6,00	1
40636	120,00	36	8,5	7,50	1
40640	138,70	40	8,5	11,00	1



### Sartén

Poêle · Pfanne  
Frying pan · Sertã

Ref	€	Ø (cm)	h (cm)	e (mm)	U.Venta
40619	32,90	18	4,5	0,7	1
40621	35,00	20	4,5	0,7	1
40623	36,30	22	5,0	0,7	1
40625	38,80	24	5,2	0,7	1
40627	40,00	26	6,0	0,7	1
40629	42,90	28	6,5	0,7	1



### Cuecepastas sin tapa

Cuit-pâte sans couvercle · Nudelkoch-Einsatz ohne Deckel  
Pastacooker without lid · Coze-massas sem tampa

Ref	€	Ø (cm)	h (cm)	L	U.Venta
40426	66,50	24	17,5	9,50	1

# GOURMET

## Colección



### ES

- Favorece una distribución rápida y homogénea del calor.
- Extremadamente robustos.
- Acabado pulido brillante exterior y lijado mate interior.
- Apta para todo tipo de cocinas (incluido inducción y horno).
- Triple fondo difusor que asegura un eficiente reparto del calor.

### FR

- Toute la pièce (corps, poignées et manches) est fabriquée en acier inoxydable 18/10.
- Favorise une distribution rapide et homogène de la chaleur.
- Extrêmement robustes.
- Finition extérieure polie brillante et intérieur limage mat.
- Compatible avec tout type de cuisinières (y compris induction et four).
- Triple fond diffuseur qui garantit une répartition efficace de la chaleur.

### EN

- The whole product (body, handles and grips) is made in 18/10 stainless steel.
- It favours quick and homogeneous heat distribution.
- Extremely robust.
- Exterior glossy, polished finish and sanded matte interior.
- Suitable for all types of cooking surfaces (including induction and the oven).
- Triple diffuser bottom assuring efficient distribution of heat.



#### Cacerola con tapa

Faitout avec couvercle · Bratentopf mit Deckel  
Casserole with lid · Caçarola com tampa

Ref	€	Ø (cm)	h (cm)	L	U.Venta
90016	43,60	16	8,0	1,50	1
90018	46,70	18	8,5	2,00	1
90020	51,30	20	8,5	2,50	1
90022	55,60	22	9,0	3,00	1
90024	60,10	24	9,5	3,50	1
90026	67,40	26	9,5	4,50	1
90028	82,70	28	11,0	6,50	1
90032	102,80	32	12,5	9,50	1



#### Olla con tapa

Marmite avec couvercle · Fleischtopf mit Deckel  
Stock pot with Lid · Panela com tampa

Ref	€	Ø (cm)	h (cm)	L	U.Venta
90116	47,80	16	13,0	2,50	1
90118	51,70	18	14,0	3,50	1
90120	54,80	20	14,5	4,50	1
90122	61,00	22	14,5	5,50	1
90124	67,60	24	15,0	6,50	1
90126	72,90	26	15,0	7,50	1
90128	90,60	28	17,0	10,00	1
90132	117,40	32	17,5	13,50	1



#### Olla super alta con tapa

Marmite S. Haute a/couvercle · Hoher Fleischtopf mit Deckel  
Deep Stock pot with Lid · Panela super alta com tampa

Ref	€	Ø (cm)	h (cm)	L	U.Venta
90125	77,60	24	20,0	9,00	1
90129	100,70	28	22,0	13,50	1



#### Cacerola vapor

Panier vapeur · Dampfkoch-Aufsatz  
Steam casserole · Caçarola a vapor

Ref	€	Ø (cm)	h (cm)	L	U.Venta
90420	39,70	20	8,5	2,50	1
90424	48,80	24	9,5	3,50	1



#### Tartera con tapa

Plat rond a/couvercle · Pfanne mit Deckel  
Round dish with lid · Tarteira com tampa

Ref	€	Ø (cm)	h (cm)	L	U.Venta
90620	51,30	20	6,5	2,00	1
90622	54,90	22	6,5	2,50	1
90624	58,70	24	7,0	3,00	1
90626	63,60	26	7,0	3,50	1
90628	75,70	28	8,0	4,50	1
90632	94,20	32	8,0	6,00	1



#### Pote cilíndrico

Pot-cilindrique · Milchtopf  
Cylindrical pot · Caneca cilíndrica

Ref	€	Ø (cm)	h (cm)	L	U.Venta
90712	29,60	12	12,0	1,00	1
90714	31,30	14	12,5	1,50	1
90716	35,20	16	13,0	2,50	1
90718	38,10	18	14,0	3,50	1



#### Cazo recto

Casserole · Stielkasserole, flach  
Saucepan · Caçarola direita

Ref	€	Ø (cm)	h (cm)	L	U.Venta
90212	26,60	12	7,0	0,80	1
90214	28,10	14	7,5	1,00	1
90216	31,50	16	8,0	1,50	1
90218	34,10	18	8,5	2,00	1
90220	38,20	20	8,5	2,50	1



#### Colador esférico

Passoire à queue · Seiher, mit Stiel  
Strainer · Colador esférico

Ref	€	Ø (cm)	h (cm)	U.Venta
90318	31,30	18	8,5	1



#### Escurridera

Passoire sur pied · Abtropfschüssel  
Colander with stand · Escorredor

Ref	€	Ø (cm)	h (cm)	U.Venta
90324	47,40	24	11,0	1



#### Tapa

Couvercle · Deckel  
Lid · Tampa

Ref	€	Ø (cm)	U.Venta
90916	11,70	16	1
90918	11,70	18	1
90920	11,80	20	1
90922	12,00	22	1
90924	13,20	24	1
90926	14,20	26	1
90928	18,60	28	1
90932	24,00	32	1

# BASIC

## Colección



ES

- Toda la pieza (cuerpo, asas y mangos) fabricada en acero inoxidable.
- La tapa, con cierre de precisión, preserva los aromas y retiene el calor.
- Ideal para cocinar de forma saludable y ahorrar energía.
- Acabado interior lijado satinado y exterior pulido brillante.
- Apta para todo tipo de cocinas (incluido inducción y horno).
- Apta para el lavavajillas.

FR

- Toute la pièce (corps, poignées et manches) est fabriquée en acier inoxydable.
- Le couvercle, avec fermeture de précision, préserve les arômes et retient la chaleur.
- Idéal pour cuisiner sainement et réaliser des économies d'énergie.
- Finition intérieure limée satinée et extérieur polie brillante.
- Compatible avec tout type de cuisinières (y compris induction et four).
- Apte pour le lave-vaisselle.

EN

- The whole product (body, handles and grips) is made in stainless steel.
- The cover, with precision fit, retains the aromas and heat.
- Ideal for cooking healthy while saving energy.
- A sanded, satin interior finish and shiny, polished exterior.
- Suitable for all types of cooking surfaces (including induction and the oven).
- Dishwasher safe.



### Cacerola con tapa

Faitout a/couvercle · Bratentopf mit Deckel  
Casserole with lid · Caçarola com tampa

Ref	€	Ø (cm)	h (cm)	L	U.Venta
32016	32,40	16	8,0	1,50	1
32020	39,40	20	8,5	2,50	1
32024	48,90	24	9,5	3,50	1
32028	63,20	28	11,0	6,50	1



### Olla con tapa

Marmite avec couvercle · Fleischtopf mit Deckel  
Stock pot with Lid · Panela com tampa

Ref	€	Ø (cm)	h (cm)	L	U.Venta
32116	39,40	16	13,0	2,50	1
32120	43,70	20	13,5	4,50	1
32124	55,30	24	15,0	6,50	1
32128	71,90	28	17,0	10,00	1



### Olla super alta con tapa

Marmite S. Haute a/couvercle · Hoher Fleischtopf mit Deckel  
Deep Stock pot with Lid · Panela super alta com tampa

Ref	€	Ø (cm)	h (cm)	L	U.Venta
32125	67,80	24	20,0	9,00	1
32129	85,60	28	22,5	13,50	1



### Cacerola vapor

Panier vapeur · Dampfkoch-Aufsatz  
Steam casserole · Caçarola a vapor

Ref	€	Ø (cm)	h (cm)	L	U.Venta
32420	25,10	20	8,5	2,50	1
32424	29,40	24	9,5	3,50	1



### Cazo recto

Casserole · Stielkasserole, flach  
Saucepan · Caçarola direita

Ref	€	Ø (cm)	h (cm)	L	U.Venta
32214	19,20	14	7,5	1,00	1
32216	22,20	16	8,0	1,50	1
32218	24,60	18	8,5	2,00	1
32220	28,00	20	8,5	2,50	1



### Tartera con tapa

Plat rond avec couvercle · Pfanne mit Deckel  
Round dish with lid · Tarteira com tampa

Ref	€	Ø (cm)	h (cm)	L	U.Venta
32624	41,00	24	7,0	3,00	1
32628	57,50	28	8,0	4,50	1



Ø20

Ø18

Ø16

Ø14



### Pote cilíndrico

Pot-cilindrique · Milchtopf  
Cylindrical pot · Caneca cilíndrica

Ref	€	Ø (cm)	h (cm)	L	U.Venta
32714	24,60	14	12,5	1,50	1
32716	28,80	16	13,0	2,50	1



### Escurridera

Passoire sur pied · Abtropfschüssel  
Colander with stand · Escorredor

Ref	€	Ø (cm)	h (cm)	U.Venta
32324	52,20	24	11,0	1



### Colador esférico

Passoire à queue · Seiher, mit Stiel  
Strainer · Coador esférico

Ref	€	Ø (cm)	h (cm)	U.Venta
32318	37,70	18	8,5	1



### Tapa

Couvercle · Deckel  
Lid · Tampa

Ref	€	Ø (cm)	U.Venta
32916	9,30	16	1
32920	11,20	20	1
32924	13,10	24	1
32928	16,40	28	1



# NOVA-LADYCOR

## Colección



### ES

- Cuerpo fabricado en acero inoxidable 18/10.
- Asas, mangos y pomo en baquelita termoaislante.
- Destaca por su diseño clásico, funcionalidad y sencillez.
- Acabado pulido brillante exterior y lijado mate interior.
- Triple fondo difusor que asegura un eficiente reparto del calor.
- Apta para todo tipo de cocinas (incluido inducción).
- Apta para el lavavajillas.

### FR

- Corps fabriqué en acier inoxydable 18/10.
- Poignées, manches et pommeau en bakélite thermo-isolante.
- Se distingue par son style classique, sa fonctionnalité et sa simplicité.
- Finition polie brillante extérieur et image mat intérieur.
- Triple fond diffuseur qui garantit une répartition efficace de la chaleur.
- Compatible avec tout type de cuisinières (y compris induction).
- Apte pour le lave-vaisselle.

### EN

- Body made in 18/10 stainless steel.
- Handles, grips and knob in heat resistant bakelite.
- Stands out for its classic design, functionality and simplicity.
- Exterior glossy, polished finish and sanded matte interior.
- Triple diffuser bottom assuring efficient distribution of heat.
- Suitable for all types of cooking surfaces (including induction).
- Dishwasher safe.



### Cacerola con tapa

Faitout avec couvercle · Bratentopf mit Deckel  
Casserole with lid · Caçarola com tampa

Ref	€	Ø (cm)	h (cm)	L	U.Venta
88016	44,40	16	8,0	1,50	1
88018	47,50	18	8,5	2,00	1
88020	51,70	20	8,5	2,50	1
88022	56,60	22	9,0	3,00	1
88024	60,40	24	9,5	3,50	1
88026	67,70	26	9,5	4,50	1
88028	82,40	28	11,0	9,50	1
88032	104,80	32	12,5	9,50	1



### Olla con tapa

Marmite avec couvercle · Fleischtopf mit Deckel  
Stock pot with Lid · Panela com tampa

Ref	€	Ø (cm)	h (cm)	L	U.Venta
88116	48,90	16	13,0	2,50	1
88118	51,60	18	14,0	3,50	1
88120	55,20	20	14,5	4,50	1
88122	60,40	22	14,5	5,50	1
88124	67,50	24	15,0	6,50	1
88126	75,00	26	15,0	7,50	1
88128	91,30	28	17,0	10,00	1
88132	110,20	32	17,5	13,50	1



### Olla super alta con tapa

Marmite S. Haute a/couvercle · Hoher Fleischtopf mit Deckel  
Deep Stock pot with Lid · Panela super alta com tampa

Ref	€	Ø (cm)	h (cm)	L	U.Venta
88121	60,30	20	17,5	5,50	1
88125	76,70	24	20,0	9,00	1
88129	108,00	28	22,0	13,50	1



### Cacerola vapor

Panier vapeur · Dampfkoch-Aufsatz  
Steam casserole · Caçarola a vapor

Ref	€	Ø (cm)	h (cm)	L	U.Venta
88420	41,30	20	9,0	2,50	1
88424	50,70	24	10,5	3,50	1



### Pote cilíndrico

Pot-cilindrique · Milchtopf  
Cylindrical pot · Caneca cilíndrica

Ref	€	Ø (cm)	h (cm)	L	U.Venta
88712	28,90	12	12,0	1,00	1
88714	31,30	14	12,5	1,50	1
88716	34,20	16	13,0	2,50	1
88718	37,70	18	14,0	3,50	1



### Colador esférico

Passoire à queue · Seiher, mit Stiel  
Strainer · Coador esférico

Ref	€	Ø (cm)	h (cm)	U.Venta
88318	33,80	18	8,5	1



### Escurridera

Passoire sur pied · Abtropfschüssel  
Colander with stand · Escorredor

Ref	€	Ø (cm)	h (cm)	U.Venta
88324	47,80	24	11,0	1



### Cazo recto

Casserole · Stielkasserole, flach  
Saucepan · Caçarola direita

Ref	€	Ø (cm)	h (cm)	L	U.Venta
88212	26,40	12	7,0	0,80	1
88214	27,30	14	7,5	1,00	1
88216	30,00	16	8,0	1,50	1
88218	32,90	18	8,5	2,00	1
88220	37,70	20	8,5	2,50	1



### Tartera con tapa

Plat rond avec couvercle · Pfanne mit Deckel  
Round dish with lid · Tarteira com tampa

Ref	€	Ø (cm)	h (cm)	L	U.Venta
88620	51,30	20	6,5	2,00	1
88622	55,20	22	6,5	2,50	1
88624	59,20	24	7,0	3,00	1
88626	63,70	26	7,0	3,50	1
88628	72,50	28	8,0	4,50	1
88632	92,60	32	8,0	6,00	1



### Tapa

Couvercle · Deckel  
Lid · Tampa

Ref	€	Ø (cm)	U.Venta
88916	10,40	16	1
88918	10,60	18	1
88920	11,20	20	1
88922	11,50	22	1
88924	12,30	24	1
88926	13,80	26	1
88928	17,10	28	1
88932	23,40	32	1

# ESTUDIO Colección



ES

- Cuerpo fabricado en acero inoxidable 18/10.
- Asas, mangos y pomo en baquelita termoaislante.
- Su pomo abatible consigue una reducción del espacio manteniendo una ergonomía perfecta.
- Acabado pulido brillante exterior y lijado mate interior.
- Triple fondo difusor que asegura un eficiente reparto del calor.
- Apta para todo tipo de cocinas (incluido inducción).
- Apta para el lavavajillas.

FR

- Corps fabriqué en acier inoxydable 18/10.
- Poignées, manches et pommeau en bakélite thermo-isolante.
- Son pommeau rabattable permet un gain d'espace en conservant une ergonomie parfaite.
- Finition extérieur polie brillante et intérieur limage mat.
- Triple fond diffuseur qui garantit une répartition efficace de la chaleur.
- Compatible avec tout type de cuisinières (y compris induction).
- Apte pour le lave-vaisselle.

EN

- Body made in 18/10 stainless steel.
- Handles, grips and knob in heat resistant bakelite.
- Its folding knob reduces storage space maintaining ergonomic perfection.
- Exterior glossy, polished finish and sanded matte interior.
- Triple diffuser bottom assuring efficient distribution of heat.
- Suitable for all types of cooking surfaces (including induction).
- Dishwasher safe.



### Cacerola con tapa

Faitout avec couvercle · Bratentopf mit Deckel  
Casserole with lid · Caçarola com tampa

Ref	€	Ø (cm)	h (cm)	L	U.Venta
85016	44,90	16	8,0	1,50	1
85018	48,40	18	8,5	2,00	1
85020	52,80	20	8,5	2,50	1
85022	56,70	22	9,0	3,00	1
85024	61,10	24	9,5	3,50	1
85026	66,70	26	9,5	4,50	1
85028	76,80	28	11,0	6,50	1



### Olla con tapa

Marmite a/couvercle · Fleischtopf mit Deckel  
Stock pot with Lid · Panela com tampa

Ref	€	Ø (cm)	h (cm)	L	U.Venta
85118	51,50	18	14,0	3,50	1
85120	56,60	20	14,5	4,50	1
85122	61,80	22	14,5	5,50	1
85124	67,70	24	15,0	6,50	1
85126	72,90	26	15,0	7,50	1
85128	86,10	28	17,0	10,00	1



### Olla super alta con tapa

Marmite S. Haute a/couvercle 3 Hoher Fleischtopf mit Deckel  
Deep Stock pot with Lid · Panela super alta com tampa

Ref	€	Ø (cm)	h (cm)	L	U.Venta
85125	77,00	24	20,0	9,00	1
85129	95,00	28	22,0	13,50	1



### Cacerola vapor

Panier vapeur · Dampfkoch-Aufsatz  
Steam casserole · Caçarola a vapor

Ref	€	Ø (cm)	h (cm)	L	U.Venta
85420	39,60	20	9,0	2,50	1
85424	48,50	24	10,5	3,50	1



### Pote cilíndrico

Pot-cilindrique · Milchtopf  
Cylindrical pot · Caneca cilíndrica

Ref	€	Ø (cm)	h (cm)	L	U.Venta
85712	29,50	12	12,0	1,00	1
85714	31,60	14	12,5	1,50	1
85716	33,50	16	13,0	2,50	1
85718	37,20	18	14,0	3,50	1



### Lote 5 cazos

Ensemble 5 casseroles · Set 5 Tlg. Stielkasserollen  
Set 5 saucepans · Lote de 5 caçarola

Ref	€	U.Venta
85003	154,10	1



### Cazo recto

Casserole · Stielkasserole, flach  
Saucepan · Caçarola direita

Ref	€	Ø (cm)	h (cm)	L	U.Venta
85212	26,10	12	7,0	0,80	1
85214	27,30	14	7,5	1,00	1
85216	30,00	16	8,0	1,50	1
85218	33,30	18	8,5	2,00	1
85220	37,50	20	8,5	2,50	1



### Sautex

Sauteuse · Sautouse  
Sauteuse · Frigideira

Ref	€	Ø (cm)	h (cm)	L	U.Venta
85624	40,40	24	7,0	3,50	1



### Sartén

Poêle · Pflanne  
Frying pan · Sertãs

Ref	€	Ø (cm)	h (cm)	L	U.Venta
85625	38,20	24	7,0	3,50	1
85629	41,50	28	8,0	4,50	1

Pomo abatible · Folding knob



### Tapa

Couvercle · Deckel  
Lid · Tampa

Ref	€	Ø (cm)	U.Venta
85916	9,20	16	1
85918	9,90	18	1
85920	10,90	20	1
85922	11,10	22	1
85924	12,30	24	1
85926	12,80	26	1
85928	16,50	28	1

# GARINOX

## Colección



### ES

- Cuerpo fabricado en acero inoxidable 18/10.
- Asas, mangos y pomo en baquelita termoaislante.
- Acabado pulido brillante.
- Fondo Termodifusor (inox 18/10 - aluminio - inox).
- Apta para todo tipo de cocinas (incluido inducción).
- Apta para el lavavajillas.

### FR

- Corps fabriqué en acier inoxydable 18/10.
- Poignées, manches et pommeau en bakélite thermo-isolante.
- Finition polie brillante.
- Fond thermo-diffuseur (inox 18/10 - aluminium - inox).
- Compatible avec tout type de cuisinières (y compris induction).
- Apte pour le lave-vaisselle.

### EN

- Body made in 18/10 stainless steel.
- Handles, grips and knob in heat resistant bakelite.
- Glossy polished finish.
- Heat diffuser bottom (18/10 stainless steel - aluminium - stainless Steel).
- Suitable for all types of cooking surfaces (including induction).
- Dishwasher safe.



### Cacerola con tapa

Faitout a/couvercle · Bratentopf mit Deckel  
Casserole with lid · Caçarola com tampa

Ref	€	Ø (cm)	h (cm)	L	U.Venta
14318	28,60	18	9,0	2,00	1
14320	33,00	20	10,0	3,00	1
14322	39,00	22	11,0	4,00	1
14324	45,00	24	12,0	5,00	1



### Olla con tapa

Marmite avec couvercle · Fleischtopf mit Deckel  
Stock pot with Lid · Panela com tampa

Ref	€	Ø (cm)	h (cm)	L	U.Venta
14420	35,40	20	12,0	3,80	1
14422	41,50	22	13,0	5,00	1
14424	49,70	24	15,0	7,00	1



### Cazo recto

Casserole · Stielkasserole, flach  
Saucepan · Caçarola direita

Ref	€	Ø (cm)	h (cm)	L	U.Venta
14212	10,20	12	5,5	0,60	1
14214	12,70	14	6,5	1,00	1
14216	15,80	16	7,5	1,50	1
14218	19,10	18	9,0	2,00	1
14220	22,50	20	10,0	3,00	1

### ES

#### CAZO

- Fabricados en acero inoxidable de gran calidad.
- Mango de baquelita termoaislante.
- Acabado pulido brillante.

#### CAZO VERTEADOR

- Fabricados en acero inoxidable de gran calidad.
- Con pico vertedor.
- Mango de baquelita termoaislante.
- Acabado pulido brillante.
- Ideal para calentar leche, hacer chocolate y salsas.

### FR

#### CAZO

- Fabriqué en acier inoxydable de haute qualité.
- Manche en bakélite thermo-isolante.
- Finition polie brillante.

#### TIROIR VERSEUR

- Fabriqué en acier inoxydable de haute qualité.
- Avec bec verseur.
- Poignée en bakélite thermo-isolante.
- Finition polie brillante.
- Idéal pour chauffer le lait, préparer du chocolat et des sauces.

### EN

#### CAZO

- Made of high quality stainless steel.
- Heat-insulating bakelite handle.
- Bright polished finish.

#### POURING DRAWER

- Made of high quality stainless steel.
- With pouring spout.
- Heat-insulating bakelite handle.
- Shiny polished finish.
- Ideal for heating milk, making chocolate and sauces.

# New

Inox



### Cazo recto

Casserole · Stielkasserole, flach  
Saucepan · Caçarola direita

Ref	€	Ø (cm)	h (cm)	L	U.Venta
31212	9,10	12	6,5	0,50	1
31214	10,40	14	7,0	1,00	1
31216	11,60	16	7,5	1,50	1
31218	13,20	18	8,0	2,00	1
31220	14,20	20	8,0	2,50	1

Inox



### Cazo vertedor

Casserole · Stielkasserole  
Saucepan · Caçarola direita de verter

Ref	€	Ø (cm)	h (cm)	L	U.Venta
31312	9,40	12	6,5	0,50	1
31314	10,70	14	7,0	1,00	1
31316	11,90	16	7,5	1,50	1
31318	13,50	18	8,0	2,00	1
31320	14,10	20	8,0	2,50	1

**Ideal para calentar leche, chocolate y salsas.**

Ideal for heating milk, making chocolate and sauces.



# FORTE Colección



## ES

- Fabricada en aluminio fundido y construida en una sola pieza.
- Máxima robustez y gran resistencia a la deformación.
- Revestimiento antiadherente interior y exterior, libre de PFOA.

## FR

- Fabriquée en fonte d'aluminium et construite en une seule pièce.
- Robustesse maximale et grande résistance à la déformation.
- Revêtement antiadhésif intérieur et extérieur sans PFOA.
- Inclut un couvercle en verre trempé avec soupape résistante aux chocs.

## EN

- Made in Cast Aluminium and in a single piece.
- Maximum robustness and great resistance to deformation.
- Interior non-stick coating and exterior, PFOA free.
- It includes a tempered glass cover with pressure valve resistant to bumps.



### Cacerola con tapa cristal

Faitout avec couvercle verre · Bratentopf mit Glasdeckel  
Round casserole with glass lid · Caçarola com tampa de vidro

Ref	€	Ø (cm)	h (cm)	L	U.Venta
25816	31,60	16	8,5	1,50	1
25820	34,20	20	8,5	2,50	1
25824	42,70	24	10,5	4,50	1
25828	52,30	28	12,5	7,00	1
25831	62,10	30	13,5	8,70	1



### Cacerola baja con tapa cristal

Faitout bas avec couvercle verre · Bratentopf mit Glasdeckel  
Round low casserole with glass lid · Caçarola baixa com tampa de vidro

Ref	€	Ø (cm)	h (cm)	L	U.Venta
25823	42,90	24	7,5	2,60	1
25827	52,60	28	7,5	3,60	1
25832	68,10	32	7,5	5,20	1
25835	78,80	36	8,5	7,50	1



### Cacerola cuadrada con tapa cristal

Faitout carré avec couvercle verre · Bratentopf mit Glasdeckel  
Square casserole with glass lid · Caçarola quadrada com tampa de vidro

Ref	€	cm	h (cm)	L	U.Venta
25829	61,80	28x28	12,0	7,50	1

# STILO Colección



### Cacerola con tapa cristal

Faitout avec couvercle verre · Bratentopf mit Glasdeckel  
Casserole with glass lid · Caçarola com tampa de vidro

Ref	€	Ø (cm)	h (cm)	L	U.Venta
27320	52,10	20	10,5	2,50	1
27324	60,40	24	12,0	4,00	1
27328	71,20	28	12,5	6,00	1



### Tartera con tapa cristal

Faitout bas avec couvercle verre · Bratentopf mit Glasdeckel  
Low casserole with glass lid · Caçarola baixa com tampa de vidro

Ref	€	Ø (cm)	h (cm)	L	U.Venta
27327	67,50	28	8,5	4,00	1



### Sartén

Poêle · Pfanne  
Frying pan · Sertã

Ref	€	ØD (cm)	Ød (cm)	h (cm)	U.Venta
27620	34,60	20	16,5	4,5	6
27624	39,50	24	20,0	5,2	6
27626	43,60	26	21,5	5,5	6
27628	47,10	28	24,0	6,0	6



### Cazo recto

Casserole · Stielkasserole, flach  
Saucepan · Caçarola direite

Ref	€	Ø (cm)	h (cm)	L	U.Venta
27416	33,20	16	7,5	1,20	1
27418	35,40	18	8,8	1,80	1

Aro protector de silicona  
Silicone protective ring



Válvula salida de vapor  
Steam outlet valve

### Tapa cristal

Couvercle verre · Glasdeckel  
Glass lid · Tampa de vidro

Ref	€	Ø (cm)	U.Venta
27920	9,00	20	1
27924	10,30	24	1
27928	12,70	28	1



### Grill

Grill · Grill Induktionfähig  
Grill · Grelhador

Ref	€	cm	Ød (cm)	h (cm)	U.Venta
27625	43,60	24x24	18,6	4,8	1
27629	50,50	28x28	21,5	5,2	1

# TITANIUM PRO

## Colección



ES

- Cacerola robusta y duradera gracias a su cuerpo fabricado en aluminio fundido.
- Fabricada en una sola pieza.
- Libre de materiales pesados y tóxicos. ECO y libre de PFOA.
- Compatible con todas las fuentes de calor, incluida la inducción.
- Fácil limpieza interior y exterior.

FR

- Casserole robuste et durable grâce à son corps fabriqué en fonte d'aluminium.
- Fabriquée en une seule pièce.
- Sans matériaux lourds et toxiques. ECO et sans PFOA.
- Compatible avec toutes les sources de chaleur, y compris l'induction.
- Nettoyage intérieur et extérieur facile.

EN

- Robust and durable casserole thanks to its cast aluminium body.
- One piece construction.
- Free of heavy and toxic materials. ECO and PFOA-free.
- Compatible with all heat sources, including induction.
- Easy to clean interior and exterior



- Tapa de vidrio templado reforzada con un aro protector de silicona antipactos y una válvula de salida de vapor.
- Couvercle en verre trempé renforcé avec un pourtour de protection en silicone anti-impacts et une valve de sortie de vapeur.
- Tempered glass lid reinforced with an anti-shock silicone protective ring and a steam outlet valve.

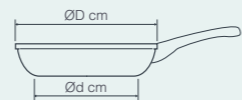

ANTIADHERENTE

PPG Quantanium<sup>®</sup>  
Titanium-reinforced non-stick coating

- High release topcoat
- Partially reinforced midcoat
- Reinforced primer (titanium-based particles)
- Metal substrate

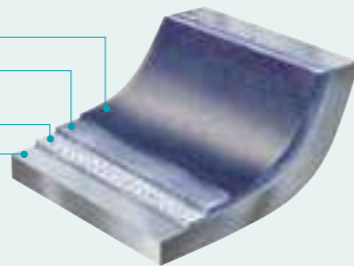

- Asas EXTRAÍBLES fabricadas en silicona de máxima calidad, termoaislantes, altamente resistentes y ergonómicas, permiten un agarre seguro. Mango con acabado SOFT TOUCH, termoaislante, altamente resistente y ergonómico, permite un agarre seguro.

- Poignées AMOVIBLES fabriquées en silicone de la plus grande qualité, thermo-isolantes, hautement résistantes et ergonomiques, qui permettent de tenir l'ustensile en toute sécurité. Manche avec finition SOFT TOUCH, thermo-isolant, hautement résistant et ergonomique, permet une prise en main sûre.
- Heat insulating, highly resistant, ergonomic REMOVABLE handles made of high quality silicone which provide a secure grip on pots and pans. Handle with SOFT TOUCH finish, heat insulating, highly resistant and ergonomic, allows a secure grip.

- FULL INDUCTION; asegura un rendimiento óptimo en todo tipo de cocinas, con un reparto de calor inmejorable logrando la máxima eficiencia y ahorro de energía.

- FULL INDUCTION ; garantit un rendement optimal sur tout type de cuisinière, avec une répartition de la chaleur unique, obtenant ainsi une efficacité et une économie d'énergie maximales.

- FULL INDUCTION diffuser base ensures optimum performance with all kinds of cookers. Its unbeatable heat distribution achieves the best efficiency and energy savings.



Incluye asas de silicona  
Includes silicone handles



### Cacerola con tapa

Faitout avec couvercle · Bratentopf mit Deckel  
Casserole with lid · Caçarola com tampa

Ref	€	Ø (cm)	h (cm)	L	U.Venta
27520	50,60	20	9,5	2,60	1
27524	61,20	24	11,0	4,40	1
27528	74,50	28	12,0	6,60	1

Incluye asas de silicona  
Includes silicone handles



### Tartera con tapa

Plat rond avec couvercle · Pfanne mit Deckel  
Round dish with lid · Tarteira com tampa

Ref	€	Ø (cm)	h (cm)	L	U.Venta
27728	69,70	28	7,5	4,10	1
27732	83,60	32	8,0	5,70	1
27736	98,50	36	8,0	7,30	1



### Grill

Grill · Grill Induktionfähig  
Grill · Grelhador

Ref	€	cm	Ød (cm)	h (cm)	U.Venta
27827	53,40	28x28	21,0	4,0	1

Válvula salida de vapor  
Steam outlet valve



Aro protector de silicona  
Silicone protective ring

### Tapa de cristal

Couvercle en verre · Glasdeckel  
Glass lid · Tampa de vidro

Ref	€	Ø (cm)	U.Venta
27420	10,40	20	1
27424	12,10	24	1
27428	14,00	28	1
27432	15,90	32	1
27436	17,70	36	1



### Cazo recto

Casserole · Stielkasserolle, flach  
Saucepan · Caçarola direita

Ref	€	Ø (cm)	h (cm)	L	U.Venta
27516	29,30	16	8,0	1,35	1



### Sartén

Poêle · Pfanne  
Frying-pan · Sertã

Ref	€	ØD (cm)	Ød (cm)	h (cm)	U.Venta
27820	30,70	20	16,6	5,0	6
27824	37,80	24	20,2	5,5	4
27828	45,90	28	23,4	6,0	6



### Sartén 4 cavidades

Poêle 4 cavités · Pfanne, 4-fache Einteilung  
Frying-pan 4 cavities · Sertã 4 cavidades

Ref	€	cm	Ød (cm)	h (cm)	U.Venta
27832	46,20	32x26	21,0	3,5	1

Si  
Silicone



### Asas para batería TITANIUM

Poignées · Griffchutz, Silikon  
Handles · Asas

Ref	€	Ø (cm)	U.Venta
R27520A	4,30	20	1
R27528A	4,40	24-28	1
R27732A	5,50	32-36	1

# FIT Colección



## ES

- Tratamiento electrolítico, el aluminio se sella completamente y se endurece para que no pase a los alimentos.
- Gran durabilidad y ultrarresistente: superficie robusta altamente resistente a roces, deformación y corrosión.
- Difunde el calor de forma uniforme evitando el sobrecalentamiento y obteniendo excelentes resultados de cocción.
- Mangos / Asas de acero inoxidable con remaches de aluminio que impiden la transferencia de calor.
- Tapas de vidrio templado reforzadas en el borde con acero inoxidable.
- Compatible con todas las fuentes de calor, incluida la inducción.

## FR

- Traitement électrolytique, l'aluminium est totalement scellé et durcit pour ne pas pouvoir atteindre les aliments.
- Grande durabilité et ultra résistante : Surface robuste hautement résistante aux rayures, à la déformation et à la corrosion.
- Diffuse la chaleur de façon uniforme, évitant ainsi la surchauffe et obtenant d'excellents résultats de cuisson.
- Anses et poignées en acier inoxydable avec des rivets en aluminium qui empêchent le transfert de chaleur.
- Couverts en verre trempé renforcés avec le bord en acier inoxydable.
- Compatible avec toutes les sources de chaleur, y compris l'induction.

## EN

- Electrolytic treatment, the aluminium is completely sealed and hardened so no metal is passed on to the food.
- Extremely durable and ultra-high strength: It has a robust surface that is highly resistant to abrasion, warping and corrosion.
- It distributes heat evenly to avoid overheating and provide excellent cooking results.
- Stainless steel handles with aluminium rivets that avoid heat transfer.
- The lid is tempered glass with stainless steel reinforcement around the edge.
- Compatible with all heat sources, including induction.

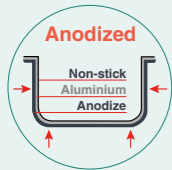

- Capa de óxido natural de protección muy gruesa.
- Couche d'oxydation naturelle de protection très épaisse.
- Thick natural oxide protective layer.



- Muy resistentes a arañazos, deformaciones y corrosión.
- Très résistante aux rayures, à la déformation et à la corrosion.
- Very resistant to scratches, deformation and corrosion.

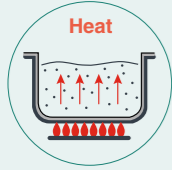

- Distribuye uniformemente el calor, sin áreas de sobrecalentamientos.
- Distribue uniformément la chaleur, sans zones de surchauffe.
- Hot spot free, uniform heat distribution.

## ANTIADHERENTE

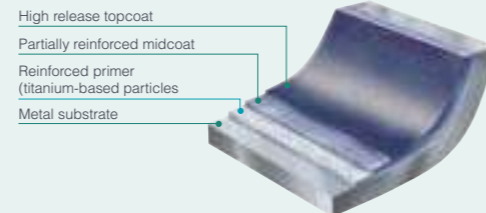

- Antiadherente QuanTanium® reforzado con partículas de titanio; libre de materiales tóxicos y pesados, ecológico y libre de PFOA.
- Antiadhésif QuanTanium® renforcé avec des particules de titane ; sans matériaux toxiques ni métaux lourds, écologique et sans PFOA.
- QuanTanium® non-stick reinforced with titanium particles; free from toxic and heavy materials, environmentally friendly and PFOA-free.



## Cacerola con tapa

Faitout avec couvercle · Bratentopf mit Deckel  
Casserole with lid · Caçarola com tampa

Ref	€	Ø (cm)	h (cm)	L	e (mm)	U.Venta
48016	42,60	16	8,0	1,50	4,5	1
48020	51,70	20	9,0	2,60	4,5	1
48024	63,50	24	10,0	4,20	4,5	1
48028	74,60	28	11,0	6,30	4,5	1



## Olla con tapa

Marmite avec couvercle · Fleichtopf mit Deckel  
Stock pot with lid · Panela com tampa

Ref	€	Ø (cm)	h (cm)	L	e (mm)	U.Venta
48116	49,10	16	13,0	2,50	4,5	1
48120	58,10	20	14,0	4,20	4,5	1
48124	73,00	24	15,0	6,50	4,5	1
48128	87,20	28	17,0	10,00	4,5	1



## Cazo recto

Casserole · Stielkasserolle, flach  
Saucepan · Caçarola direita

Ref	€	Ø (cm)	h (cm)	L	e (mm)	U.Venta
48214	29,60	14	7,5	1,00	4,5	1
48216	33,00	16	8,0	1,50	4,5	1
48218	37,10	18	9,0	2,10	4,5	1
48220	42,00	20	10,0	2,90	4,5	1



## Tartera con tapa

Plat rond avec couvercle · Pfanne mit Deckel  
Round dish with lid · Tarteira com tampa

Ref	€	Ø (cm)	h (cm)	L	e (mm)	U.Venta
48624	57,30	24	7,0	2,90	4,5	1
48628	68,50	28	8,0	4,50	4,5	1

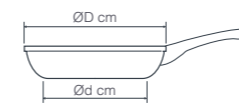

## Sartén

Poêle · Pfanne  
Frying pan · Sertã

Ref	€	ØD (cm)	Ød (cm)	h (cm)	L	e (mm)	U.Venta
48720	32,30	20	15,0	4,0	0,90	4,5	6
48724	40,40	24	18,0	4,5	1,50	4,5	6
48728	48,20	28	22,0	5,0	2,70	4,5	6

Vidrio templado  
Tempered glass



Aro protector de acero inoxidable  
Stainless steel protective ring

Válvula salida de vapor  
Steam outlet valve

## Tapa

Couvercle · Deckel  
Lid · Tampa

Ref	€	Ø (cm)	U.Venta
48916	12,00	16	1
48920	13,50	20	1
48924	14,90	24	1
48928	16,60	28	1

# EASY Colección



## ES

- Fabricadas en aluminio forjado de máxima calidad.
- Excelente conductividad térmica.
- Recubrimiento antiadherente TRlcapa, reforzado a base de partículas de piedra.
- Libres de materiales tóxicos y pesados, ecológico y 100% libre de PFOA.
- Fondo FULL INDUCTION compatible con todas las fuentes de calor, incluida la inducción.
- Asas / Mango de fundición de acero inoxidable.
- Tapa de vidrio templado reforzada en el borde con acero inoxidable.

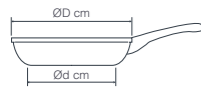

### Cacerola con tapa

Faitout avec couvercle · Bratentopf mit Deckel  
Casserole with lid · Caçarola com tampa

Ref	€	Ø (cm)	h (cm)	L	e (mm)	U.Venta
27040	47,30	20	8,5	2,00	3,00	1
27044	59,10	24	10,5	3,50	3,00	1
27048	71,20	28	12,5	6,00	3,00	1

## FR

- Fabriquée en aluminium forgé de la plus grande qualité.
- Excellente conductivité thermique.
- Revêtement antiadhésif TRlcapa, renforcé à base de particules de pierre.
- Sans matériaux toxiques ni métaux lourds, écologique et 100% sans PFOA.
- Fond FULL INDUCTION compatible avec toutes les sources de chaleur, y compris l'induction.
- Poignées / Manche en fonte d'acier inoxydable.
- Couvercle en verre trempé renforcé sur le bord avec de l'acier inoxydable.



### Cacerola baja con tapa

Faitout bas avec couvercle · Bratentopf mit Deckel  
Round low casserole with lid · Caçarola baixa com tampa

Ref	€	Ø (cm)	h (cm)	L	e (mm)	U.Venta
27034	50,10	24	6,5	2,00	3,00	1
27038	58,80	28	7,0	3,00	3,00	1

## EN

- Made of top quality forged aluminium.
- Excellent thermal conductivity.
- TRlcapa non-stick coating, reinforced with stone particles.
- Free of toxic, heavy materials, environmentally friendly and 100% PFOA-free.
- With FULL INDUCTION base and compatible with all heat sources, including induction.
- Cast stainless steel grips / handle.
- Tempered glass lid with reinforced stainless steel edge.



### Cazo recto

Casserole · Stielkasserolle, flach  
Saucepan · Caçarola direite

Ref	€	Ø (cm)	h (cm)	L	e (mm)	U.Venta
27056	33,50	16	7,5	1,00	3,00	1
27058	36,60	18	8,0	1,50	3,00	1
27060	40,50	20	8,5	2,00	3,00	1

Mango de fundición de acero inoxidable  
Cast stainless steel handle



### Sartén

Poêle · Pfanne  
Frying-pan · Sertã

Ref	€	ØD (cm)	h (cm)	e (mm)	U.Venta	U.Venta
27018	20,50	18	4,0	3,0	6	6
27020	21,30	20	4,0	3,0	6	6
27022	23,10	22	4,5	3,0	6	6
27024	25,00	24	4,5	3,0	6	6
27026	27,20	26	5,0	3,0	6	6
27028	29,80	28	5,5	3,0	6	6
27030	32,60	30	5,5	3,0	6	6
27032	34,50	32	6,0	3,0	6	6

Vidrio templado  
Tempered glass

Aro protector de acero inoxidable  
Stainless steel protective ring



Válvula salida de vapor  
Steam outlet valve

### Tapa

Couvercle · Deckel  
Lid · Tampa

Ref	€	Ø (cm)	U.Venta
27070	11,30	20	1
27074	13,10	24	1
27078	14,20	28	1

## New



### Sartén honda

Poêle profonde · Tiefe Pfanne  
Deep frying-pan · Sertã funda

Ref	€	ØD (cm)	Ød (cm)	h (cm)	e (mm)	U.Venta
27134	30,40	24	x	6,5	3,0	1
27138	36,30	28	x	7,0	3,0	1

## New



### Wok

Wok · Wok  
Wok · Wok

Ref	€	Ø (cm)	Ød (cm)	h (cm)	e (mm)	U.Venta
27148	34,10	28	xx	8,0	3,0	1

## New



### Grill

Grill · Grill Inductionfähhing  
Grill · Grelhador

Ref	€	cm	Ød (cm)	h (cm)	e (mm)	U.Venta
27158	37,50	28x28	xx	4,0	3,0	1

## New



### Crepera

Crêpiere · Crêpes Pfanne  
Crepiere · Crepeira

Ref	€	ØD (cm)	Ød (cm)	h (cm)	e (mm)	U.Venta
27144	26,90	24	17,0	1,7	3,0	1

# COCOTTES

## Colección



HINWEIS: In Deutschland nicht verfügbar

### ES

- Fabricadas en aluminio fundido.
- Diseño atractivo y funcional.
- Garantizan la absorción y distribución uniforme del calor, sin puntos de sobrecalentamiento.
- La distribución del calor uniforme por toda la pieza hace que los alimentos no pierdan su jugo durante la cocción, conservando así todos sus nutrientes y vitaminas.
- Las puntas situadas bajo la tapa, hacen que las gotas fruto de la condensación, vuelvan a caer sobre los alimentos formando un flujo circulante y permanente reduciendo la pérdida de sabores y jugos de los alimentos.
- Es la pieza perfecta para: arroces, carnes, pescados, legumbres, verduras, guisos, cremas, salsas, sopas, etc.
- Revestimiento antiadherente ILAG:ULTIMATE.

### FR

- Fabriquée en fonte d'aluminium.
- Style attractif et grande fonctionnalité.
- Garantit l'absorption et la distribution uniforme de la chaleur, sans points de surchauffe.
- La distribution de la chaleur uniforme sur toute la pièce permet aux aliments de ne pas perdre leur jus pendant la cuisson, conservant ainsi tous leurs nutriments et vitamines.
- Les pointes situées sous le couvercle permettent aux gouttes issues de la condensation de retomber sur les aliments, formant ainsi un flux permanent de circulation qui réduit la perte des saveurs et des jus des aliments.
- C'est la pièce parfaite pour : riz, viandes, poissons, légumes, ragoûts, crèmes, sauces, soupes, etc.
- Revêtement antiadhésif ILAG: ULTIMATE.

### EN

- Made in cast aluminium.
- Attractive design and great functionality.
- It guarantees the absorption and uniform distribution of heat, without overheating points.
- The uniform distribution of heat throughout the product makes keep its juices during cooking, preserving all its nutrients and vitamins.
- The points located under the lid cause the condensation drops to fall back onto the food, forming a permanent and circulating flow and reducing the loss of the food's flavours and juices.
- This is an ideal product for: rice, meats, fish, beans, vegetables, stews, creams, sauces, soups, etc.
- Non-stick coating ILAG: ULTIMATE.



### Cacerola con tapa MINI

Faitout avec couvercle "MINI" · "MINI" Bratentopf mit Deckel  
"MINI" round casserole with lid · Çaçarola com tampa "MINI"

	Ref	€	Ø (cm)	h (cm)	L	U.Venta
A	25909	22,50	10	5,0	0,24	12
	25914	33,00	14	7,5	0,90	1
B	25910	22,50	10	5,0	0,24	1
	25915	33,00	14	7,5	0,90	1



### Cacerola oval con tapa MINI

Faitout Ovale avec couvercle "MINI" · "MINI" Oval Bratentopf mit Deckel  
"MINI" oval round casserole with lid · Çaçarola oval com tampa "MINI"

	Ref	€	cm	h (cm)	L	U.Venta
A	25911	23,70	12x8,5	5,0	0,25	1
B	25912	22,40	12x8,5	5,0	0,25	1



### Cacerola con tapa

Faitout avec couvercle · Bratentopf mit Deckel  
Round casserole with lid · Çaçarola com tampa

	Ref	€	Ø (cm)	h (cm)	L	U.Venta
	25916	48,60	16	7,0	1,30	1
	25920	63,30	20	8,0	2,40	1
A	25924	81,70	24	10,0	4,20	1
	25928	104,20	28	11,5	6,70	1
B	25917	54,00	16	7,0	1,30	1
	25921	71,20	20	8,0	2,40	1
	25925	89,10	24	10,0	4,20	1
	25929	109,00	28	11,5	6,70	1



### Cazo recto

Casserole · Stielkasserole, flach  
Saucepan · Çaçarola direite

Ref	€	ØD (cm)	Ød (cm)	h (cm)	e (mm)	L	U.Venta
25956	29,70	16	12,0	8,0	1,6	1,30	1
25958	33,30	18	15,0	8,5	1,6	1,80	1
25950	36,50	20	16,5	9,0	1,6	2,40	1

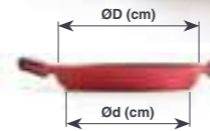

### Paellera

Plat rond · Pfanne  
Round · Paelheira

Ref	€	ØD (cm)	Ød (cm)	h (cm)	e (mm)	Raciones	U.Venta
25932	82,10	32	25,5	4,5	1,6	5	1
25936	95,90	36	29,5	4,5	2,0	7	1
25940	106,60	40	33,5	4,5	2,0	9	1



### Cacerola oval con tapa

Faitout Ovale avec couvercle · Oval Bratentopf mit Deckel  
Oval round casserole with lid · Çaçarola oval com tampa

	Ref	€	cm	h (cm)	L	U.Venta
A	25927	75,30	26x20	9,0	3,50	1
	25931	103,40	31x25	11,0	6,30	1
B	25933	81,30	26x20	9,0	3,50	1
	25935	112,00	31x25	11,0	6,30	1



### Manoplas de silicona GRIS

Mouffettes en silicone · Griffchutz aus Silikon  
Silicone mittens · Pegas de silicone

Ref	€	Ø (cm)	U.Venta
R25917G	8,20	16	6
R25921G	7,80	20-24-28	6
R25933G	8,20	26x20	6
R25935G	7,80	31x25	6

- Fabricadas en aluminio fundido. Revestimiento antiadherente Xylan Plus.
- Garantizan la absorción y distribución uniforme del calor, sin puntos de sobrecalentamiento.
- La distribución del calor uniforme por toda la pieza hace que los alimentos no pierdan su jugo durante la cocción, conservando así todos sus nutrientes y vitaminas.
- Fondo difusor FULL INDUCTION; asegura un rendimiento óptimo en todo tipo de cocinas, con un reparto de calor inmejorable logrando la máxima eficiencia y ahorro de energía.
- Perfectas para arroces, carnes, pescados, legumbres, verduras, guisos, cremas, salsas, sopas, etc.
- Diseño atractivo y funcional.
- Compatibles con todo tipo de cocinas, incluida la inducción.

- Made in cast aluminium. Non-stick coating Xylan Plus.
- It guarantees the absorption and uniform distribution of heat, without overheating points.
- The uniform distribution of heat throughout the product makes keep its juices during cooking, preserving all its nutrients and vitamins.
- The FULL INDUCTION diffuser bottom ensures optimal performance on all kinds of cookers with unbeatable heat distribution that achieves maximum efficiency and energy savings.
- Ideal product for: rice, meats, fish, beans, vegetables, stews, creams, sauces, soups, etc.
- Attractive design and great functionality.
- It's compatible with all kinds of cookers, including induction.



# MINI Colección



## ES

- Fabricadas en aluminio fundido de máxima calidad.
- Ideal tanto para cocinar como para presentar aperitivos o platos.
- Antiadherente bicapa de alta calidad y 100% libre de PFOA.
- Libres de materiales tóxicos, pesados, disolventes y sustancias químicas.
- Diseñadas para una cocina saludable: permite cocinar sin apenas aceite garantizando que los alimentos no se peguen.
- Distribución homogénea del calor que permite una cocción rápida y uniforme.
- Aptas para todo tipo de fuegos: gas, eléctrica, vitrocerámica e inducción.
- Tapa fabricada en vidrio templado con válvula de salida de vapor.
- Pomo baquelita con acabado Soft Touch.
- Mango ergonómico con acabado Soft Touch.

## FR

- Fabriqué en fonte d'aluminium de la plus grande qualité.
- Idéale aussi bien pour cuisiner que pour la d'apéritifs ou de plats.
- Finition antiadhésive bi-couche de grande qualité et 100% sans PFOA.
- Sans matériaux toxiques, métaux lourds, dissolvants et substances chimiques.
- Conçue pour une cuisine saine : permet de cuisiner sans à peine utiliser d'huile et avec la garantie que les aliments ne collent pas.
- Distribution homogène de la chaleur, ce qui permet une cuisson rapide et uniforme.
- Apte pour tous types de feux : gaz, électricité, vitrocéramique, four et induction.
- Couvercle fabriqué en verre trempé avec valve à vapeur.
- Poignée en bakélite avec finition Soft Touch.
- Manche ergonomique avec finition Soft Touch.

## EN

- Made from a single piece of top quality cast aluminium.
- It's perfect for both cooking and presenting appetisers or dishes.
- It has a high quality bi-layer non-stick coating that is 100% PFOA free.
- It's free of toxic materials, heavy metals, solvents and chemical substances.
- It's designed for healthy cooking. It lets you cook with practically no oil and be sure that food won't stick.
- Food is cooked quickly and evenly because of the homogeneous heat distribution.
- It's suitable for all kinds of cookers: gas, electric, vitroceramic, oven and induction.
- The lid is made of tempered glass with a steam valve.
- Bakelite handle with a Soft Touch finish.
- Ergonomic handle with a Soft Touch finish.



### Cacerola con tapa

Faitout avec couvercle · Bratentopf mit Deckel  
Casserole with lid · Caçarola com tampa

Ref	€	Ø (cm)	ØBase (cm)	h (mm)	e (mm)	L	U.Venta
25160	20,90	16	12,0	5,0	1,6	0,8	1



### Cazo recto

Casserole · Stielkasserole, flach  
Saucepan · Caçarola direite

Ref	€	Ø (cm)	ØBase (cm)	h (mm)	e (mm)	L	U.Venta
25164	16,20	14	10,0	8,0	1,6	1,0	1



### Paellera

Plat à paella · Pfanne  
Round dish · Paelheira

Ref	€	Ø (cm)	ØBase (cm)	h (mm)	e (mm)	L	U.Venta
25161	20,90	20	11,5	4,5	1,8	1,0	1



### Sartén

Poêle · Pfanne  
Frying pan · Sertã

Ref	€	Ø (cm)	ØBase (cm)	h (mm)	e (mm)	U.Venta
25163	12,80	14	10,0	3,0	1,6	1



### Grill

Grill · Grill Induktionfähig  
Grill · Grelhador

Ref	€	cm	ØBase (cm)	h (mm)	e (mm)	U.Venta
25162	14,10	14x14	10,0	2,5	1,6	1

# SMALT Colección



## ES

- Cacerola y paellera de hierro muy resistentes.
- Cubiertas con una capa de esmalte vitricado antiácido de máxima calidad.
- Asas altamente reforzadas.
- Perfectas para presentar y servir sabrosas tapas, raciones o pinchos.

## FR

- Faitout et poêle à paella en fer très résistantes.
- Possèdent un revêtement avec une couche d'acier émaillé de la plus grande qualité.
- Anses hautement renforcées.
- Parfaites pour présenter et servir de savoureuses tapas, de petites portions ou des amuse-bouches.

## EN

- Extremely strong metal casserole and paella dish.
- Coated with a layer of top quality antacid vitrified enamel.
- Heavily reinforced handles.
- Perfect for serving or presenting delicious tapas, dishes or pinchos.



### Cacerola esmaltada

Faitout à paella · Bratentopf, emailiert  
Casserole · Caçarola esmaltada

Ref	€	Ø (cm)	h (cm)	U.Venta
60192	6,50	12	4,0	1
60196	7,70	16	4,5	1
60190	8,50	20	4,7	1



### Paellera esmaltada

Plat à paella · Paellapfanne, emailiert  
Round dish for paella · Paelheira esmaltada

Ref	€	Ø (cm)	U.Venta
60170	5,10	10	10
60172	5,70	12	10
60175	6,70	15	6
60180	8,60	20	6

# MAGMA

## Colección



ES

- Construida en una sola pieza.
- Recubierta con una capa de aceite vegetal.
- Ideal para cocinar, prolonga suavemente la cocción.
- Gran conductor del calor, mantiene el calor mientras disfrutas y saboreas la comida.
- Base de madera para servir y presentar la comida recién cocinada.

FR

- Construite en une seule pièce.
- Revêtu d'une couche d'huile végétale.
- Idéal pour cuisiner, prolonge délicatement la cuisson.
- Grand conducteur de chaleur, maintient le plat au chaud pendant que vous dégustez la nourriture.
- Base en bois pour servir et présenter le plat fraîchement cuisiné.

EN

- Built in one piece.
- Coated with a layer of vegetable oil.
- Ideal for cooking; gently continues to cook.
- Great heat conductor; retains heat while you enjoy and savour the food.
- Wooden base to serve and present freshly cooked food.



### Cacerola

Faitout · Bratentopf  
Casserola · Caçarola

Ref	€	Ø (cm)	ml	U.Venta
25771	10,70	12,5	230	4
25772	15,60	16,2	470	4
25773	18,80	18,5	720	1



### Cacerola con base

Faitout avec basse · Bratentopf mit Holzsockel  
Casserola with base · Caçarola com base

Ref	€	Ø (cm)	ml	U.Venta
25871	15,40	12,5	230	4
25872	21,00	16,2	470	1
25873	27,00	18,5	720	1



### Cacerola oval

Faitout ovale · Oval Bratentopf  
Oval casserola · Caçarola oval

Ref	€	cm	ml	U.Venta
25781	12,10	15x10	200	4
25782	19,00	17,5x12,5	300	1
25783	21,60	21,7x15	700	1



### Cacerola oval con base

Faitout ovale avec basse · Oval Bratentopf mit Holzsockel  
Oval casserola with base · Caçarola oval com base

Ref	€	cm	ml	U.Venta
25881	15,60	15x10	200	4
25882	24,00	17,5x12,5	300	1
25883	26,70	21,7x15	700	1



### Mini plancha grill lisa rectangular

Mini plaque grill lisse rectangulaire · Mini Platte Grill, glatt, rechteckiger  
Mini rectangular grill plaque flat · Mini plancha grill liso rectangular

Ref	€	cm	h (cm)	U.Venta
25774	10,20	17x10	2,5	4



### Mini plancha grill lisa rectangular con base

Mini plaque Grill lisse rectang. a/basse · Mini Platte Grill, glatt, rechteckiger m/Holzsockel  
Mini rectangular grill plaque flat with base · Mini plancha grill liso rectangular c/base

Ref	€	cm	h (cm)	U.Venta
25874	15,00	17x10	2,5	4



### Mini plancha grill cuadrado

Mini plaque grill carré · Mini Platte Grill, Quadrat  
Mini square grill plaque · Mini plancha grill cuadrado

Ref	€	cm	h (cm)	U.Venta
25775	10,70	14x14	1,7	4



### Mini plancha grill cuadrado con base

Mini plaque grill carré avec basse · Mini Platte Grill, Quadrat mit Holzsockel  
Mini square grill plaque with base · Mini plancha grill cuadrado com base

Ref	€	cm	h (cm)	U.Venta
25875	15,00	14x14	1,7	4



### Mini grill

Mini grill · Mini Grill  
Mini grill · Mini grill

Ref	€	cm	h (cm)	U.Venta
25776	11,10	14x14	2,5	4



### Mini grill con base

Mini grill avec basse · Mini Grill mit Holzsockel  
Mini grill with base · Mini grill com base

Ref	€	cm	h (cm)	U.Venta
25876	17,30	14x14	2,5	1



### Mini sartén lisa

Mini poêle lisse · Mini Pfanne  
Mini frying pan flat · Mini sertã lisa

Ref	€	Ø (cm)	h (cm)	U.Venta
25777	11,20	13	1,7	4



### Mini sartén lisa c/base

Mini poêle lisse avec basse · Mini Pfanne mit Holzsockel  
Mini frying pan flat with base · Mini sertã lisa com base

Ref	€	Ø (cm)	h (cm)	U.Venta
25877	16,10	13	1,7	1

# MAGMA GREY & RED

## Colección



ES

- Acabado exterior e interior esmaltado, muy resistente y de gran durabilidad.
- Muy versátil: ideal para cocinar asados, arroces, pasta, cocer a fuego lento e incluso hornear tartas dulces y pan.
- Conserva todos los nutrientes, vitaminas y sabores de los alimentos.
- Excelente retención y distribución uniforme del calor.
- Incluye base de madera, ideal para servir y presentar.
- Apta para todo tipo de fuegos.

FR

- Finition extérieure et intérieure émaillée. Émail très résistant et d'une grande durabilité.
- Très versatile : idéale pour cuisiner des ragoûts, du riz, des pâtes, cuire à feu doux et même enfourner des gâteaux et du pain.
- Conserve tous les nutriments, les vitamines et les saveurs des aliments.
- Excellente rétention et distribution uniforme de la chaleur.
- Inclut une base en bois, idéale pour servir et présenter.
- Apte pour tous types de feux.

EN

- Enamel finish inside and outside. Very strong and durable enamel.
- Extremely versatile: perfect for roasts, rice, pasta, low heat cooking and even baking bread or cake.
- Preserves all the nutrients, vitamins and flavours of the food.
- Excellent heat retention and uniform heat distribution.
- Wooden base included, perfect for serving or presentation.
- Appropriate for all kinds of cookers.



### Cacerola redonda

Faitout rond · Rund Bratentopf  
Round casserole · Caçarola redonda

	Ref	€	Ø (cm)	h (cm)	ml	U.Venta
	25841	17,60	12,0	3,0	200	1
A	25848	27,30	16,2	3,0	470	1
	25849	33,90	18,5	3,0	720	1
	25851	17,60	12,0	3,0	200	1
B	25858	27,30	16,2	3,0	470	1
	25859	33,90	18,5	3,0	720	1

### Cacerola oval

Faitout ovale · Oval Bratentopf  
Oval casserole · Caçarola oval

	Ref	€	cm	h (cm)	ml	U.Venta
	25842	23,50	17,5x12,5	3,0	250	1
A	25840	33,80	21,7x15	3,0	700	1
	25852	23,70	17,5x12,5	3,0	250	1
B	25850	34,10	21,7x15	3,0	700	1



### Sartén

Poêle · Pflanne  
Frying pan · Sertā

	Ref	€	Ø (cm)	h (cm)	ml	U.Venta
A	25843	17,70	13,5	3,0	275	1
B	25853	17,70	13,5	3,0	275	1

### Cacerola redonda con tapa

Faitout rond avec couvercle · Rund Bratentopf mit Deckel  
Round casserole with lid · Caçarola redonda com tampa

	Ref	€	Ø (cm)	h (cm)	ml	U.Venta
A	25846	28,50	10	5,0	200	1
B	25856	28,50	10	5,0	200	1



### Cacerola rectangular con tapa

Faitout rectangulaire avec couvercle · Bratentopf, rechteckig mit Deckel  
Rectangular casserole with lid · Caçarola rectangular com tampa

	Ref	€	cm	h (cm)	ml	U.Venta
A	25845	33,40	13x9	4,5	300	1
B	25855	33,40	13x9	4,5	300	1

### Cacerola oval con tapa

Faitout ovale avec couvercle · Oval Bratentopf mit Deckel  
Oval casserole with lid · Caçarola oval com tampa

	Ref	€	cm	h (cm)	ml	U.Venta
A	25847	33,80	13x10	5,0	400	1
B	25857	33,80	13x10	5,0	400	1



# CHEF-LUXE

## Olla a presión

Inox 18/10  
 Sandwich Vitro Electric Gas Induction Oven Cuerpo/Body Dishwasher Cuerpo/Body



Sistema de apertura y cierre con una sola mano  
 Opening and closing system with one hand

ES

- Sistema de apertura y cierre con una sola mano.
- Selección de posiciones (3 posiciones: 0 - I - II).
- Se puede utilizar como una cacerola normal.

FR

- Ouverture et de fermeture d'une seule main.
- Sélection positions(3 positions: 0 - I - II).
- Peut être utilisé comme une casserole normale.

EN

- Opening and closing system with one hand.
- Selecting positions (3 position: 0 - I - II).
- Can be used as a normal casserole.



### Olla a presión

Cocotte à pression · Schnellkochtopf  
 Pressure cooker · Panela de pressão

Ref	€	Ø (cm)	h (cm)	L	U.Venta
50815	590,80	32	18,0	15,0	1
50818	608,00	32	23,0	20,0	1
50823	638,70	32	32,0	23,0	1



### Cuerpo olla a presión

Corps cocotte à pression · Schnellkochtopf-Körper  
 Pressure cooker stockpot · Corpo panela de pressão

Ref	€	Ø (cm)	h (cm)	L	U.Venta
50816	203,90	32	18,0	15,0	1
50819	221,10	32	23,0	20,0	1
50824	251,80	32	32,0	23,0	1



### Tapa

Couvercle · Deckel  
 Lid · Tampa

Ref	€	Ø (cm)	U.Venta
A 50934	386,90	32	1
B 54932	27,80	32	1

Ollas a presión  
 Pressure Cookers

# ROBUST

## Olla a presión



ES

- Diseñada para uso profesional.
- Fabricada en aluminio de máxima calidad (grado de pureza 99,55%).
- Especialmente indicada para cocinas de gas, eléctricas y vitrocerámicas.
- Excelente conductor térmico. Rápida y eficiente. Posee un elevado rendimiento energético (70%).
- Triple sistema de seguridad.
- Puente más robusto y resistente.
- Asas de baquelita antiquemaduras.

FR

- Conçue pour un usage professionnel.
- Il est conçu en aluminium haute qualité (degré de pureté de 99,5 %).
- Adaptée aux gaz, cuisinières électriques et plaques de cuisson.
- Excellent conducteur thermique. Rapide et efficace. Confère un rendement énergétique élevé (70%).
- Triple système de sécurité.
- Pont plus robuste et résistant.
- Poignées en bakélite anti-brûlures.

EN

- For Professional use.
- Made of high quality aluminium (with a 99.5% degree of purity).
- Suitable for gas, electric, cookers and cooktops.
- Excellent thermal conductivity. Fast and efficient. High energy performance (70%).
- Triple safety system.
- Stronger and more robust bridge.
- Anti-scald bakelite handles.



**Triple sistema de seguridad**  
Triple safety system

1  
2  
3



Asas de baquelita antiquemaduras

Anti-scald bakelite handles



### Olla a presión

Cocotte à pression · Schnellkochtopf  
Pressure cooker · Panela de pressão

Ref	€	Ø (cm)	h (cm)	L	U.Venta
20830	1.357,80	42	31	30	1
20840	1.447,90	42	39	40	1
20850	1.538,30	42	46	50	1

# PRO-CLASSIC

## Olla a presión



ES

- Diseñada para uso profesional.
- Fabricada en aluminio.
- Especialmente indicada para cocinas de gas, eléctricas y vitrocerámicas.
- Excelente conductor térmico. Rápida y eficiente. Posee un elevado rendimiento energético (70%).
- Válvula de presión/contrapeso: permite que se libere el vapor regulando la presión interior de la olla.
- Válvula de seguridad/despresurización: actúa en caso en el que falle la válvula de presión.
- Puente más robusto y resistente.
- Asas de baquelita antiquemaduras.

FR

- Conçue pour un usage professionnel.
- Fabriquée en aluminium.
- Adaptée aux gaz, cuisinières électriques et plaques de cuisson.
- Excellent conducteur thermique. Rapide et efficace. Confère un rendement énergétique élevé (70%).
- Soupape à pression/contreponds : permet de libérer la vapeur en régulant la pression intérieure de l'autocuiseur.
- Soupape de sécurité/dépressurisation : agit dans le cas d'un dysfonctionnement de la soupape à pression.
- Pont plus robuste et résistant.
- Poignées en bakélite anti-brûlures.

EN

- For Professional use.
- Made of aluminium.
- Suitable for gas, electric, cookers and cooktops.
- Excellent thermal conductivity. Fast and efficient. High energy performance (70%).
- The pressure/counterweight valve lets steam escape and regulates pressure inside the pot.
- Safety/depressurisation valve: acts in case of failure of the pressure valve.
- Stronger and more robust bridge.
- Anti-scald bakelite handles.



	Válvula de seguridad Safety valve	Válvula de cocción Cooking valve
A	1	1
B	1	2
C	2	2



### Olla a presión

Cocotte à pression · Schnellkochtopf  
Pressure cooker · Panela de pressão

	Ref	€	Ø (cm)	h (cm)	L	U.Venta
	20511	111,50	28	19,0	11,0	1
	20515	128,20	30	25,0	15,0	1
A	20518	159,50	32	23,0	18,0	1
	20522	177,30	34	23,0	22,0	1
	20533	211,90	36	32,0	33,0	1
B	20540	229,80	40	32,5	40,0	1
C	20550	274,50	44	34,0	50,0	1

New  
New

# CLASSIC

## Olla a presión



ES

- Fabricada en acero inoxidable 18/10 de máxima calidad.
- Marcaje interior, grabado con la capacidad del uso de la olla.
- Asas de baquelita antiquemaduras. Válvula de seguridad.
- Apta para todo tipo de cocinas. Triple fondo FULL INDUCTION para una distribución rápida y homogénea del calor.
- \* Las referencias 71872-71875 contienen un cestillo.

FR

- Fabrication en acier inoxydable 18/10 de qualité maximale.
- Marquage intérieur, marquage gravé de la capacité d'utilisation de l'autocuiseur.
- Poignées en bakélite anti-brûlures. Soupape de sécurité.
- Apte pour tout type de feux. Triple fond FULL INDUCTION pour une distribution rapide et homogène de la chaleur.
- \* Les références 71872-71875 contiennent un panier.

EN

- Manufactured in high-quality 18/10 stainless steel.
- Inner marking, engraved with the cooker's capacity.
- Burn-resistant Bakelite handles Safety valve.
- Suitable for any type of hob. Tri-ply FULL INDUCTION base for quick, even heat distribution.
- \* The 71872-71875 references contain a basket.



Marcajes de capacidad en litros

Capacity markings inside in litres



Asas de baquelita antiquemaduras

Anti-scald bakelite handles



### Olla a presión

Cocotte à pression · Schnellkochtopf  
Pressure cooker · Panela de pressão

Ref	€	Ø (cm)	h (cm)	L	U.Venta
71874	86,60	22	11,5	4,0	1
71876	95,00	22	17,0	6,0	1
71878	103,90	24	19,0	8,0	1
71871	113,20	24	23,0	10,0	1
71872	178,60	26	23,0	12,0	1 *
71875	192,30	26	29,0	15,0	1 *

# GENIUS

## Olla a presión



ES

- Fabricada: acero inoxidable 18/10 de máxima calidad. Acabado pulido espejo exterior.
- Marcaje interior: Grabado con la capacidad del uso de la olla.
- Cierre fácil y seguro: Gracias a su asa ergonómica, es fácil y cómodo de abrir.
- Triple fondo difusor: Garantiza una óptima difusión del calor, favoreciendo un importante ahorro de energía (70%) y una cocción uniforme resaltando el aroma y sabor de los alimentos.
- Sistema de seguridad: Válvula de seguridad, actúa en caso de aumento excesivo de presión, despresurizando rápidamente la olla.
- Apta para todo tipo de cocinas y el lavavajillas.

FR

- Fabrication : En acier inoxydable 18/10 de qualité maximale. Finition polissage miroir extérieur.
- Marquage intérieur : Marquage gravé de la capacité d'utilisation de l'autocuiseur.
- Fermeture facile et sûre : Grâce à son manche ergonomique, permet une ouverture simple et pratique.
- Triple fonds diffuseur : Garantit une diffusion optimale de la chaleur, favorisant ainsi d'importantes économies d'énergie (70%) et une cuisson uniforme accentuant l'odeur et le goût des aliments.
- Système de sécurité : Soupape de sécurité, agit en cas d'augmentation excessive de la pression, dépressurisant rapidement
- Apte pour tout type de cuisinières et le lave-vaisselle.

EN

- Manufactured: High-quality 18/10 stainless steel. Exterior mirror-polished finish.
- Inner marking: Engraved with the cooker's capacity.
- Easy, safe closing: Thanks to its ergonomic handle, it's easy and convenient to open.
- Triple diffuser base: Ensures optimum heat diffusion, enabling a significant energy saving (70%) and even cooking that enhances the aroma and flavour of the food.
- Safety system: The safety valve operates in the case of an excessive increase in pressure, quickly releasing pressure from the cooker.
- Suitable for all types of cookers and dishwashers.

### Olla a presión

Cocotte à pression · Schnellkochtopf  
Pressure cooker · Panela de pressão

Ref	€	Ø (cm)	h (cm)	L	U.Venta
71904	59,60	22	11,5	4,0	1
71906	65,70	22	17,0	6,0	1
71908	74,10	24	19,0	8,0	1
71901	82,10	24	23,0	10,0	1



# SICURO

## Olla a presión



**Sistema de apertura y cierre con una sola mano**  
One-handed opening and closing mechanism

**Nivel de cocción: 0 y 100kpa**  
Cooking level

**Fondo termodifusor**  
Thermo-diffuser bottom



ES

- Fabricada en acero inoxidable 18/10 de máxima calidad con acabado satinado.
- Fondo termodifusor sandwich; distribución rápida y uniforme del calor.
- Marcaje interior en litros.
- Asas termorresistentes que aseguran un manejo cómodo y seguro.
- Ahorra un 70% de energía conservando el aroma y sabor de los alimentos.
- Nivel de cocción totalmente ajustable: gira el pomo y elige la presión entre 0 y 100kpa.
- Cierre fácil y 100% seguro: sistema de apertura y cierre con una sola mano.
- Triple sistema de seguridad:
  - \* Válvula de seguridad, actúa en caso de aumento excesivo de presión, despresurizando rápidamente la olla.
  - \* Sistema de bloqueo de seguridad, imposibilidad de apertura de la tapa mientras cocinamos.
  - \* Ventana lateral de seguridad.
- Compatible con todas las fuentes de calor, incluida la inducción. Cuerpo apto para el lavavajillas.

FR

- Fabriqué en acier inoxydable 18/10 de la plus grande qualité avec finition satinée.
- Fond thermo-diffuseur sandwich : distribution rapide et uniforme de la chaleur.
- Marquage intérieur en litres.
- Poignées thermorésistantes qui garantissent une prise en main pratique et sûre.
- Économise 70% d'énergie en conservant l'arôme et le goût des aliments.
- Niveau de cuisson entièrement réglable : tourner le pommeau et choisir la pression de 0 à 100 kPa.
- Fermeture facile et 100% sûre : système d'ouverture et fermeture avec une seule main.
- Triple système de sécurité :
  - \* Soupape de sécurité qui agit en cas d'augmentation excessive de la pression en dépressurisant rapidement l'autocuiseur.
  - \* Système de blocage de sécurité, impossibilité d'ouvrir le couvercle pendant la cuisson.
  - \* Fenêtre latérale de sécurité.
- Compatible avec toutes les sources de chaleur, y compris l'induction. Corps apte pour le lave-vaisselle.

EN

- Made of top quality 18/10 stainless steel with satin finish.
- Sandwich thermo-diffuser bottom for fast, even heat distribution.
- Graduated litre marks inside.
- Heat-resistant handles for comfortable, safe grip.
- Saves 70% energy whilst still retaining the aroma and flavour of the food.
- Fully adjustable cooking level: turn the knob to select the pressure setting from 0 to 100 kPa.
- Simple, 100% safe one-handed opening and closing mechanism.
- Triple safety system:
  - \* Safety valve, which opens in the event of excessive pressure and quickly depressurises the cooker.
  - \* Safety locking system, preventing the lid from being opened while cooking is in progress.
  - \* Safety pressure relief opening on the side.
- Compatible with all heat sources, including induction. Dishwasher safe body.



### Olla a presión

Cocotte à pression · Schnellkochtopf  
Pressure cooker · Panela de pressão

Ref	€	Ø (cm)	h (cm)	L	U.Venta
71784	199,20	22	11,0	4,0	1
71786	205,10	22	16,0	6,0	1
71788	215,60	22	21,1	8,0	1

# MASTER

## Olla a presión



**Niveles de cocción**  
Cooking levels

**Marcaje interior**  
Inner marking



ES

- Fabricada en acero inoxidable 18/10 de máxima calidad.
- Marcaje interior, grabado con la capacidad del uso de la olla.
- Visualizador de los niveles de cocción mediante anillos de colores.
- 2 niveles de cocción:
  - \* Rápida (verduras, hortalizas y pescados).
  - \* Superrápida (carnes y estofados).
- Válv. de seguridad · Sist. de bloqueo de seguridad · Ventanas laterales de seguridad.
- Apta para todo tipo de cocinas.
- Fondo FULL INDUCTION.

FR

- Fabrication en acier inoxydable 18/10 de qualité maximale.
- Marquage intérieur, marquage gravé de la capacité d'utilisation de l'autocuiseur.
- Visualisateur des niveaux de cuisson via anneaux de couleur.
- 2 niveaux de cuisson :
  - \* Rapide (légumes et les poissons).
  - \* Super rapide (viandes et les ragoûts).
- Soupape de sécurité · Syst. de blocage de sécurité · Fenêtres latérales de sécurité.
- Apte pour tout type de feux.
- Fond FULL INDUCTION.

EN

- Manufactured in high-quality 18/10 stainless steel.
- Inner marking, engraved with the cooker's capacity.
- Cooking level indicator-display using coloured rings.
- 2 cooking levels:
  - \* Fast (vegetables and fish).
  - \* Super-fast (meats and stews).
- Safety valve · Safety locking system · Side safety windows.
- Suitable for any type of hob.
- FULL INDUCTION base.

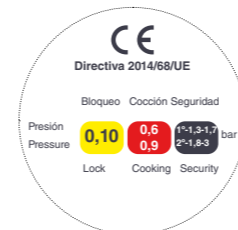

### Olla a presión

Cocotte à pression · Schnellkochtopf  
Pressure cooker · Panela de pressão

Ref	€	Ø (cm)	h (cm)	L	U.Venta
71884	79,30	22	15,5	4,0	1
71886	86,10	22	22,0	6,0	1
71887	103,80	24	23,5	8,0	1



# TEMPO

## Olla a presión



### ES

- Fabricada en acero inoxidable 18/10 de máxima calidad.
- Marcaje interior, grabado con la capacidad del uso de la olla.
- Válvula de control para seleccionar el nivel de presión.
- Niveles de cocción: cocción lenta y cocción rápida.
- Válvula de seguridad · Sistema de bloqueo de seguridad · Ventanas laterales de seguridad.
- Apta para todo tipo de cocinas.
- Triple fondo FULL INDUCTION para una distribución rápida y homogénea del calor.

### FR

- Fabrication en acier inoxydable 18/10 de qualité maximale.
- Marquage intérieur, marquage gravé de la capacité d'utilisation de l'autocuiseur.
- Valve de contrôle pour sélectionner le niveau de pression
- Niveaux de cuisson : cuisson lente et cuisson rapide.
- Soupape de sécurité · Syst. de blocage de sécurité · Fenêtres latérales de sécurité.
- Apte pour tout type de feux.
- INDUCTION TOTALE triple fond pour une distribution rapide et homogène de la chaleur

### EN

- Manufactured in high-quality 18/10 stainless steel.
- Inner marking, engraved with the cooker's capacity.
- Control valve for selecting the power level.
- Cooking levels: slow cooking and fast cooking.
- Safety valve · Safety locking system · Side safety windows.
- Suitable for any type of hob.
- Tri-ply FULL INDUCTION base for quick, even heat distribution.



**Niveles de cocción**  
Cooking levels



**Marcaje interior**  
Inner marking



### Olla a presión

Cocotte à pression · Schnellkochtopf  
Pressure cooker · Panela de pressão

Ref	€	Ø (cm)	h (cm)	L	U.Venta
71864	87,20	22	15,0	4,0	1
71866	89,70	22	23,0	6,0	1
71868	96,30	22	27,0	8,0	1

### Set de ollas a presión

Ensemble de cocottes à pression · Schnellkochtopf-Satz  
Set of pressure cooker · Conj. de panelas de pressão

Ref	€	Ø (cm)	h (cm)	L	U.Venta
71862	136,80	22	16,0	6,0	1
		22	22,0	4,0	

Sartenes  
Fryingpan



# CHEF-INOX

## Sartenes



### ES

- Fabricadas en acero inoxidable 18/10 de la mejor calidad.
- Máxima garantía en resistencia, durabilidad e higiene.
- Acabado interior y exterior lijado satinado.
- Fondo termodifusor sandwich, distribución rápida y uniforme del calor.
- Homogeneidad y eficacia térmica.
- Cocción ultrarrápida.
- Aptas para todos los fuegos.

### FR

- Fabriquées en acier inoxydable 18/10 de la meilleure qualité.
- Garantie maximale de résistance, de durabilité et d'hygiène.
- Finition interne et externe en brossage satiné.
- Fond thermo-diffuseur sandwich, distribution rapide et uniforme de la chaleur.
- Homogénéité et efficacité thermique.
- Cuisson ultra-rapide.
- Aptes pour tous les feux.

### EN

- Made of 18/10 stainless steel of the best quality.
- Maximum guarantee in resistance, durability and hygiene.
- Glossy sanded interior and exterior finish.
- Heat-diffusing sandwiched base, quick and even heat distribution.
- Thermal homogeneity and efficiency.
- Ultra-rapid cooking.
- Suitable for all types of cookers.



### Sartén CHEF-CLASSIC

Poêle · Pflanne  
Frying-pan · Sertã

Ref	€	Ø (cm)	h (cm)	e (mm)	U.Venta
51620	40,90	20	4,0	1,0	1
51624	45,20	24	4,5	1,0	1
51628	54,70	28	5,5	1,0	1
51632	65,50	32	6,0	1,0	1
51636	82,20	36	6,5	1,0	1
51640	98,30	40	6,5	1,0	1

- Sartén sin antiadherentes, fabricada en acero inoxidable, sartén ecológica.
- Ideal para cocinar como un profesional.
- Puedes utilizarlas en el horno.

- Poêle à frire antiadhésive, en acier inoxydable, poêle à frire écologique.
- Idéale pour cuisiner comme un professionnel.
- Peut être utilisée au four.

- Non-stick frying pan, made of stainless steel, ecological frying pan.
- Ideal for cooking like a professional.
- Can be used in the oven.



### Sartén CHEF-CLASSIC PLUS

Poêle · Pflanne  
Frying-pan · Sertã

Ref	€	Ø (cm)	h (cm)	e (mm)	U.Venta
51621	50,20	20	4,0	1,0	1
51625	56,30	24	4,5	1,0	1
51629	67,80	28	5,5	1,0	1
51633	84,20	32	6,0	1,0	1
51637	109,10	36	6,5	1,0	1
51641	127,20	40	6,5	1,0	1



### Sartén CHEF-CLASSIC CERAM

Poêle · Pflanne  
Frying-pan · Sertã

Ref	€	Ø (cm)	h (cm)	e (mm)	U.Venta
51720	51,90	20	4,0	1,0	1
51724	58,90	24	4,5	1,0	1
51728	71,10	28	5,5	1,0	1
51732	88,80	32	6,0	1,0	1
51736	110,00	36	6,5	1,0	1
51740	128,90	40	6,5	1,0	1

**Homogeneidad y eficacia térmica.**  
**Cocción ultrarrápida.**

Thermal homogeneity and efficiency.  
Ultra-rapid cooking.



# FERRUM Colección



## ES

- Disfruta de una sartén para toda la vida.
- Fabricadas artesanalmente con 100% hierro natural.
- Calidad Premium; duraderas y resistentes a arañazos.
- Alta conductividad térmica. El hierro al ser un excelente conductor del calor, permite conseguir y mantener la temperatura ideal de cocción con un menor consumo energético.
- Espesor 2,5 mm. Fácil limpieza.
- Cocina ecológica, cocina saludable.
- Antiadherente premium, libre de PFOA (sartén antiadherente).

## FR

- Une poêle qui vous durera toute la vie.
- Fabriquées de façon artisanale avec 100% de métal naturel.
- Qualité Premium; durables et résistantes aux rayures.
- Haute conductivité thermique. Le métal, excellent conducteur de chaleur, permet d'obtenir et de maintenir la température de cuisson idéale avec une consommation d'énergie moins importante.
- Épaisseur 2,5mm. Nettoyage facile.
- Cuisine écologique, cuisine saine.
- Antiadhésif premium, sans PFOA (Poêle antiadherent).

## EN

- Enjoy this one pan your whole life.
- Hand-made in 100% natural iron.
- Premium Quality; long lasting and resistant to scratching.
- High heat conduction. Iron is an excellent conductor of heat, allowing you to obtain and maintain the ideal temperature with less energy consumption.
- 2.5mm thickness. Easy to clean. Eco-friendly, healthy kitchen.
- Premium Quality; long lasting and resistant to scratching (Non-stick frying-pan).



**Sartén**  
Poêle · Pflanne  
Frying-pan · Sertä

Ref	€	Ø (cm)	h (cm)	e (mm)	U.Venta
* 63620	30,00	20	3,5	2,5	1
* 63624	34,60	24	4,5	2,5	1
* 63626	37,30	26	4,5	2,5	1
* 63628	39,30	28	5,0	2,5	1
* 63632	47,10	32	5,3	2,5	1
63636	60,00	36	5,5	2,5	1
63640	66,50	40	5,8	2,5	1

\* Compatible con nuestro mango de silicona (Ref.: 23900)  
Compatible with our silicone handle (Ref.: 23900)



**Sartén antiadherente**  
Poêle antiadherent · Pflanne, Antihafht  
Frying-pan, non-stick · Sertä anti-aderente

Ref	€	Ø (cm)	h (cm)	e (mm)	U.Venta
* 63720	33,90	20	3,5	2,5	1
* 63724	37,30	24	4,5	2,5	1
* 63726	39,90	26	4,5	2,5	1
* 63728	42,20	28	5,0	2,5	1
* 63732	49,60	32	5,3	2,5	1
63736	62,70	36	5,5	2,5	1
63740	72,50	40	5,8	2,5	1

\* Compatible con nuestro mango de silicona (Ref.: 23900)  
Compatible with our silicone handle (Ref.: 23900)



## Sartén honda

Poêle profonde · Tiefe Pflanne  
Deep frying-pan · Sertä funda

Ref	€	Ø (cm)	h (cm)	e (mm)	U.Venta
* 63424	50,20	24	7,0	2,5	1
* 63428	58,10	28	8,0	2,5	1
* 63432	85,80	32	8,8	2,5	1

Con asa  
With handle

\* Compatible con nuestro mango de silicona (Ref.: 23900)  
Compatible with our silicone handle (Ref.: 23900)



## Sartén Blinis

Poêle Blinis · Blinis Pflanne  
Blinis frying pan · Sertä Blinis

Ref	€	Ø (cm)	h (cm)	e (mm)	U.Venta
63613	25,00	12	2,1	2,0	6
63614	28,00	14	2,2	2,0	6



## Cazo bombado

Casserole bombée · Kasserolle, Bauchig  
Rounded saucepan · Caçarola bojuda

Ref	€	Ø (cm)	h (cm)	e (mm)	U.Venta
* 63419	46,20	20	10	2,5	1
* 63423	58,10	24	12	2,5	1

\* Compatible con nuestro mango de silicona (Ref.: 23900)  
Compatible with our silicone handle (Ref.: 23900)



## Sartén Blinis antiadherente

Poêle Blinis antiadherent · Blinis Pflanne, Antihafht  
Blinis frying pan, Non-stick · Sertä Blinis anti-aderente

Ref	€	Ø (cm)	h (cm)	e (mm)	U.Venta
63712	26,40	12	2,1	2,0	6
63714	29,10	14	2,2	2,0	6



## Asador

Rôtissoire · Grill  
Rotisserieil · Grelhador

Ref	€	Ø (cm)	h (cm)	e (mm)	U.Venta
* 63725	37,30	26	3,0	2,5	1

\* Compatible con nuestro mango de silicona (Ref.: 23900)  
Compatible with our silicone handle (Ref.: 23900)

## Asador antiadherente

Rôtissoire, antiadherent · Grill, Antihafht  
Non-stick rotisserieil · Grelhador anti-aderente

Ref	€	Ø (cm)	h (cm)	e (mm)	U.Venta
* 63727	38,40	26	3,0	2,5	1

\* Compatible con nuestro mango de silicona (Ref.: 23900)  
Compatible with our silicone handle (Ref.: 23900)

Asas de acero inoxidable  
Stainless steel handles



## Paellera

Plat à paella · Paellapflanne  
Round dish for paella · Paelheira

Ref	€	Ø (cm)	h (cm)	e (mm)	Raciones	U.Venta
63928	57,10	28	4,5	2,5	3	1
63932	64,70	32	4,7	2,5	5	1
63936	80,70	36	5,5	2,5	7	1
63940	88,90	40	5,5	2,5	9	1

Asas de acero inoxidable  
Stainless steel handles



### Plancha Grill lisa

Plaque à Grill lisse · Platte Grill, glatt  
Grill flat plaque · Plancha Grill lisa

Ref	€	cm	h (cm)	e (mm)	U.Venta
63642	69,20	37 x 27	5,0	2,5	1

Asas de acero inoxidable  
Stainless steel handles



### Plancha Grill

Plaque à Grill · Platte Grill  
Grill plaque · Plancha Grill

Ref	€	cm	h (cm)	e (mm)	U.Venta
63644	73,50	37 x 27	5,0	2,5	1



### Protector de silicona

Protection en silicone · Silikonschutz  
Silicone handle cover · Protector de silicone

Ref	€	L (cm)	U.Venta
23900	6,40	13,5	1

- Mango protector de silicona de alta calidad para sartenes.
- Fácil de colocar, se ajusta perfectamente al mango de la sartén.
- Antideslizante y termorresistente, protege de las temperaturas elevadas.
- Compatible con nuestras sartenes Robust, Ferrum, Dynamic y Tricapa Plus (Ø16-32).

- Manche de protection en silicone de grande qualité pour poêles.
- Facile à installer, il s'adapte parfaitement au manche de la poêle.
- Antidérapant et thermorésistant, il protège des températures élevées.
- Compatible avec nos poêles Ferrum, Robust, Dynamic et Tricapa Plus (Ø16-32).

- High quality protective silicone handle for frying pans.
- Easy to put on, it fits the pan handle perfectly.
- Non-slip and heat-resistant, it protects from high temperatures.
- Compatible with our Ferrum, Robust, Dynamic and Tricapa Plus frying pans (Ø16-32).



### Wok

Wok · Wok  
Wok · Wok

Ref	€	Ø (cm)	Ød (cm)	h (cm)	e (mm)	U.Venta
* 63828	48,40	28	15	8,0	2,0	1
* 63232	54,70	32	15	9,5	2,0	1

\* Compatible con nuestro mango de silicona (Ref.: 23900)  
Compatible with our silicone handle (Ref.: 23900)



### Wok antiadherente

Wok, Antiadherent · Wok, Antihalt  
Wok, non-stick · Wok anti-aderente

Ref	€	Ø (cm)	Ød (cm)	h (cm)	e (mm)	U.Venta
* 63829	50,40	28	15	8,0	2,0	1
* 63233	57,50	32	15	9,5	2,0	1

\* Compatible con nuestro mango de silicona (Ref.: 23900)  
Compatible with our silicone handle (Ref.: 23900)



### Crepera antiadherente

Crepière, antiadherent · Crêpes-Pfanne, Antihalt  
Crepiere, Non-stick · Crepeira anti-aderente

Ref	€	Ø (cm)	h (cm)	e (mm)	U.Venta
* 23323	27,20	22	1,8	2,5	1
* 23327	31,10	26	2,2	2,5	1

\* Compatible con nuestro mango de silicona (Ref.: 23900)  
Compatible with our silicone handle (Ref.: 23900)

- Se adapta a todo tipo de baterías de cocina.
- Vidrio térmico resistente a altas temperaturas.
- Borde de acero inoxidable 18/10.

- Convient à tous les types d'batteries de cuisine.
- Verre trempé résistant aux températures élevées.
- Jante en acier inoxydable 18/10.

- Fits all types of cookware.
- Tempered glass resistant to high temperatures.
- 18/10 stainless steel rim.



### Tapa de cristal con desvaporizador

Couvercle en verre avec sortie de vapeur · Glasdeckel mit Dampfloch  
Glass Lid with steam hole · Tampa de vidro con desvaporizador

Ref	€	Ø (cm)	U.Venta
71914	10,70	14	1
71916	11,00	16	1
71918	11,30	18	1
71920	12,20	20	1
71922	12,30	22	1
71924	12,80	24	1
71926	14,10	26	1
71928	14,70	28	1
71932	16,60	32	1

## BASIC & RUSTIC Wok



### ES

- Ideal para preparar salteados, quedando crujientes y conservando sus nutrientes.
- Duraderos y resistentes a arañazos.
- Alta conductividad térmica. El hierro al ser un excelente conductor del calor, permite conseguir y mantener la temperatura ideal de cocción con un menor consumo energético.
- Ligero y manejable.
- Mango ergonómico.
- Antiadherente tri-capa, libre de materiales tóxicos y pesados, ecológico y libre de PFOA.
- Fácil limpieza.
- Apta para todo tipo de cocinas, incluida la inducción

### FR

- Idéal pour les sautés, les aliments restent croustillant et conservent leurs nutriments.
- Durable et résistant aux rayures.
- Haute conductivité thermique. Le métal, excellent conducteur de chaleur, permet d'obtenir et de maintenir la température de cuisson idéale avec une consommation d'énergie moins importante.
- Léger et maniable.
- Poignée ergonomique.
- Antiadhésif à trois couches, sans matériaux toxiques ni métaux lourds, écologique et sans PFOA.
- Nettoyage facile.
- Compatible avec tout type de cuisinières.

### EN

- Ideal for making stir-fries, keeping ingredients crisp and preserving their nutrients.
- Durable and scratch-resistant.
- High thermal conductivity. Being an excellent heat conductor, iron allows the ideal cooking temperature to be quickly reached and maintained using less energy consumption.
- Lightweight and practical.
- Ergonomic handle.
- Three-layer non-stick coating, free from toxic and heavy materials, environmentally friendly and PFOA-free.
- Easy to clean.
- Suitable for all types of cooking surfaces.



### Wok antiadherente BASIC

Wok, Antiadherent · Wok, Antihalt  
Wok, Non-stick · Wok anti-aderente

Ref	€	Ø (cm)	Ød (cm)	h (cm)	e (mm)	U.Venta
63729	35,80	28	15	8,5	0,9	1
63733	36,40	32	15	9,5	0,9	1

## New



### Wok antiadherente RUSTIC

Wok, Antiadherent · Wok, Antihalt  
Wok, Non-stick · Wok anti-aderente

Ref	€	Ø (cm)	Ød (cm)	h (cm)	e (mm)	U.Venta
66128	35,80	28	15	8,5	0,9	1
66132	36,40	32	15	9,5	0,9	1

# ROBUST Colección



## ES

- Sartenes fabricadas en aluminio de máxima calidad diseñadas para uso profesional.
- Óptima distribución de calor conservando las propiedades nutritivas de los alimentos y con un mínimo gasto de aceite y energía.
- Recubrimiento antiadherente multicapa (5 capas) ecológico y libre de PFOA.
- Ideales para un uso continuo. Ligeras, manejables y fáciles de limpiar gracias a su antiadherente exterior.
- Aptas para todo tipo de cocinas, excepto inducción.

## FR

- Poêles fabriquées en aluminium de grande qualité conçues pour un usage professionnel.
- Distribution optimale de la chaleur en conservant les propriétés nutritives des aliments et avec une utilisation d'huile et d'énergie minimales.
- Revêtement antiadhésif multicouches (5 couches) écologique et sans PFOA.
- Idéales pour un usage continu. Légères, maniables et faciles à nettoyer grâce à leur revêtement antiadhésif extérieur.
- Compatibles avec tout type de cuisinière, excepté l'induction.

## EN

- Pans made in top quality aluminium and design for professional use.
- Optimal heat distribution, preserving the nutritional properties and with a minimal waste of oil and energy.
- Multi-layer (5 layers) eco-friendly non-stick coating, PFOA-free.
- Ideal for continuous use. Light, easy handling and easy to clean due to its nonstick exterior.
- Suitable for all types of cooking surfaces, except induction.



**Sartén**  
Poêle · Pfanne  
Frying-pan · Sertä

Ref	€	Ø (cm)	h (cm)	e (mm)	U.Venta
23616	14,80	16	3,5	2,5	6
23618	16,00	18	3,5	2,5	6
* 23620	19,00	20	4,0	3,5	6
* 23622	22,30	22	4,0	3,5	6
* 23624	24,40	24	4,5	3,5	6
* 23626	29,50	26	4,5	4,0	6
* 23628	31,60	28	4,5	4,0	6
* 23632	38,10	32	4,7	4,0	6
23636	49,60	36	5,5	4,0	4
23640	58,20	40	5,5	4,0	4

\* Compatible con nuestro mango de silicona (Ref.: 23900)  
Compatible with our silicone handle (Ref.: 23900)



**Sartén ROBUST PLUS**  
Poêle · Pfanne  
Frying-pan · Sertä

Ref	€	Ø (cm)	h (cm)	e (mm)	U.Venta
23816	16,60	16	3,5	2,5	6
23818	17,70	18	3,5	2,5	6
23820	21,40	20	4,0	3,5	6
23822	24,10	22	4,0	3,5	6
23824	26,80	24	4,5	3,5	6
23826	31,00	26	4,5	4,0	6
23828	36,10	28	4,5	4,0	6
23832	41,90	32	4,7	4,0	6
23836	51,40	36	5,5	4,0	4
23840	62,10	40	5,5	4,0	4



**Sartén honda**  
Poêle profonde · Tiefe Pfanne  
Deep frying-pan · Sertä funda

Ref	€	ØD (cm)	Ød (cm)	h (cm)	e (mm)	U.Venta
* 23625	41,80	24	18,5	6,5	3,5	1
* 23629	47,50	28	22,0	6,5	4,0	1

\* Compatible con nuestro mango de silicona (Ref.: 23900)  
Compatible with our silicone handle (Ref.: 23900)



**Sartén Blinis**  
Poêle Blinis · Pfanne Blinis  
Frying-pan Blinis · Sertä Blinis

Ref	€	Ø (cm)	h (cm)	e (mm)	U.Venta
23612	11,40	12	2,1	2,5	6
23614	13,40	14	2,2	2,5	6



**Wok**  
Wok · Wok  
Wok · Wok

Ref	€	Ø (cm)	h (cm)	e (mm)	U.Venta
23830	43,80	30	7,0	4,0	1

\* Compatible con nuestro mango de silicona (Ref.: 23900)  
Compatible with our silicone handle (Ref.: 23900)



**Crepera**  
Crêpière · Crêpes Pfanne  
Crepiere · Crepeira

Ref	€	Ø (cm)	h (cm)	e (mm)	U.Venta
* 23322	18,00	22	1,8	2,5	1
* 23326	22,70	26	1,8	2,7	1
* 23330	32,80	30	2,2	4,0	1

\* Compatible con nuestro mango de silicona (Ref.: 23900)  
Compatible with our silicone handle (Ref.: 23900)



**Sartén oval**  
Poêle ova · Pfanne, oval  
Oval frying-pan · Sertä oval

Ref	€	cm	h (cm)	e (mm)	U.Venta
23637	63,70	36x26	5,0	2,7	1
23641	66,30	40x29	5,5	2,7	1



**Sartén rectangular**  
Poêle rectangulière · Pfanne, rechteckig  
Rectangular frying-pan · Sertä rectangular

Ref	€	cm	h (cm)	e (mm)	U.Venta
* 23638	55,70	38x26	5,0	4,0	1

\* Compatible con nuestro mango de silicona (Ref.: 23900)  
Compatible with our silicone handle (Ref.: 23900)



**Paellera**  
Plat rond · Paellapfanne  
Round dish · Paelheira

Ref	€	Ø (cm)	h (cm)	U.Venta
23724	22,80	24	4,00	1
23728	29,90	28	4,50	1
23732	35,20	32	5,00	1
23736	42,50	36	5,50	1
23740	52,60	40	6,00	1

# ALUMINIO

## Sartenes



ES

- Sartenes fabricadas en aluminio de máxima calidad diseñadas para uso profesional.
- Recubrimiento antiadherente.
- Ecológico, libre de materiales tóxicos y pesados. Libre de PFOA.
- Aptas para todo tipo de cocinas, excepto inducción.

FR

- Poêles fabriquées en aluminium de grande qualité conçues pour un usage professionnel.
- Revêtement antiadhésif.
- Écologique, exempt de matériaux toxiques et lourds. Sans PFOA.
- Compatible tous feux sauf induction, excepté induction.

EN

- Pans made in top quality aluminium and design for professional use.
- Ecological, free of toxic and heavy materials. PFOA free.
- Suitable for all types of cooking surfaces, except induction.



**Sartén CHEF-TRICAPA**  
Poêle · Pflanne  
Frying pan · Sertã

Ref	€	Ø (cm)	h (cm)	e (mm)	U.Venta
21618	26,30	18	3,8	2,5	6
21620	28,80	20	4,0	3,5	6
21622	31,50	22	4,0	3,5	6
21624	34,80	24	4,5	3,5	6
21626	38,50	26	4,5	4,0	6
21628	43,80	28	4,5	4,0	6
21632	51,70	32	4,7	4,0	6
21636	61,60	36	5,5	4,0	4
21640	71,40	40	5,5	4,0	4



**Sartén honda CHEF-TRICAPA**  
Poêle profonde · Tiefe Pflanne  
Deep frying-pan · Sertã funda

Ref	€	ØD (cm)	Ød (cm)	h (cm)	e (mm)	U.Venta
21524	53,20	24	18,5	6,5	3,5	1
21528	65,80	28	22,0	6,5	4,0	1



**Sartén DYNAMIC**  
Poêle · Pflanne  
Frying-pan · Sertã

Ref	€	Ø (cm)	h (cm)	e (mm)	U.Venta
23416	14,80	16	3,5	2,5	6
23418	16,00	18	3,5	2,5	6
* 23420	19,00	20	4,0	3,5	6
* 23422	22,30	22	4,0	3,5	6
* 23424	24,70	24	4,5	3,5	6
* 23426	29,50	26	4,5	4,0	6
* 23428	31,90	28	4,5	4,0	6
* 23432	38,50	32	4,7	4,0	6
23436	49,60	36	5,5	4,0	4



**Sartén c/fondo ECO-CHEF**  
Poêle avec fond · Pflanne mit Boden  
Frying-pan with botton · Sertã com fundo

Ref	€	Ø (cm)	h (cm)	e (mm)	U.Venta
22718	31,30	18	3,8	2,5	6
22720	35,50	20	4,0	3,5	6
22722	38,80	22	4,0	3,5	6
22724	41,40	24	4,5	3,5	6
22726	48,00	26	4,5	4,0	6
22728	52,30	28	4,5	4,0	6
22732	61,30	32	4,7	4,0	6
22736	72,20	36	5,5	4,0	4



**Sartén con fondo TRICAPA PLUS**  
Poêle avec fond · Pflanne mit Boden  
Frying-pan with botton · Sertã com fundo

Ref	€	Ø (cm)	h (cm)	e (mm)	U.Venta
* 21718	29,10	18	3,8	2,5	6
* 21720	33,10	20	4,0	3,5	6
* 21722	35,00	22	4,0	3,5	6
* 21724	38,80	24	4,5	3,5	6
* 21726	45,20	26	4,5	4,0	6
* 21728	48,60	28	4,5	4,0	6
* 21732	56,40	32	4,7	4,0	6
21736	68,90	36	5,5	4,0	4

\* Compatible con nuestro mango de silicona (Ref.: 23900)  
Compatible with our silicone handle (Ref.: 23900)

# TITANIUM<sup>PRO</sup>

## Colección



**Sartén**  
Poêle · Pflanne  
Frying-pan · Sertã

Ref	€	ØD (cm)	Ød (cm)	h (cm)	U.Venta
27820	30,70	20	16,6	5,0	6
27824	37,80	24	20,2	5,5	4
27828	45,90	28	23,4	6,0	6



**Sartén 4 cavidades**  
Poêle 4 cavités · Pflanne, 4-fache Einteilung  
Frying-pan 4 cavities · Sertã 4 cavidades

Ref	€	cm	Ød (cm)	h (cm)	U.Venta
27832	46,20	32x26	21,0	3,5	1



**Grill**  
Grill · Grill Induktionfähig  
Grill · Grelhador

Ref	€	cm	Ød (cm)	h (cm)	U.Venta
27827	53,40	28x28	21,0	4,0	1

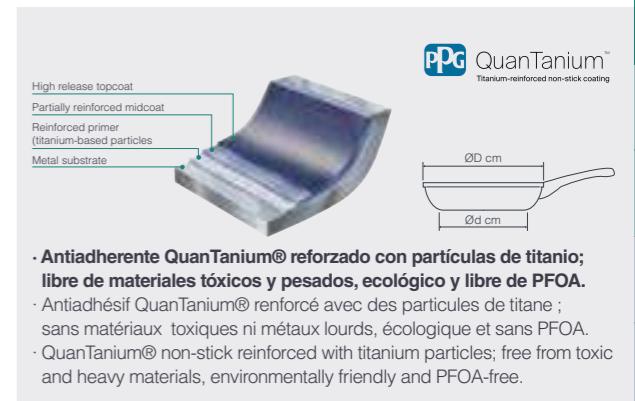

- **Antiadherente QuanTanium® reforzado con partículas de titanio; libre de materiales tóxicos y pesados, ecológico y libre de PFOA.**
- Antiadhésif QuanTanium® renforcé avec des particules de titane ; sans matériaux toxiques ni métaux lourds, écologique et sans PFOA.
- QuanTanium® non-stick reinforced with titanium particles; free from toxic and heavy materials, environmentally friendly and PFOA-free.

# STILO

## Colección



ES

- Cuerpo fabricado en una sola pieza.
- Fabricada en aluminio fundido de gran robustez.
- Recubrimiento en piedra hiperresistente a los arañazos.
- Revestimiento antiadherente de alta calidad y ecológico, libre de PFOA.
- Apta para todo tipo de cocinas, incluida la inducción.

FR

- Construite en une seule pièce.
- Fabriquée en fonte d'aluminium d'une grande robustesse.
- Revêtement en pierre hyper résistant aux rayures.
- Revêtement antiadhésif de grande qualité et écologique, exempt de PFOA.
- Compatible avec tout type de cuisines, y compris l'induction.

EN

- Body made in one piece.
- Manufactured in highly-robust cast aluminium.
- Super scratch-resistant stone coating.
- High-quality, ecological, PFOA-free anti-stick coating.
- Suitable for all types of kitchens, including those with induction cookers.

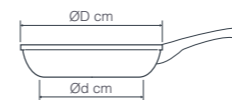

**Sartén**  
Poêle · Pflanne  
Frying pan · Sertã

Ref	€	ØD (cm)	Ød (cm)	h (cm)	U.Venta
27620	34,60	20	16,5	4,5	6
27624	39,50	24	20,0	5,2	6
27626	43,60	26	21,5	5,5	6
27628	47,10	28	24,0	6,0	6



**Grill**  
Grill · Grill Induktionfähig  
Grill · Grelhador

Ref	€	cm	Ød (cm)	h (cm)	U.Venta
27625	43,60	24x24	18,6	4,8	1
27629	50,50	28x28	21,5	5,2	1

# ECO-PIEDRA BLACK

## Colección



ES

- Fabricadas en aluminio fundido de gran calidad y espesor, están reforzadas con partículas a base de piedra y una máxima resistencia al rayado, duración y desgaste.
- La base de aluminio permite una distribución homogénea del calor, permitiendo que los alimentos se cocinen rápidamente y de manera uniforme, sin apenas utilizar aceite.
- Su antiadherente TRicapa de máxima calidad y ecológico, es libre de PFOA.
- Fácil limpieza interior y exterior gracias al antiadherente.
- Fondo FULL INDUCTION compatible con todas las fuentes de calor, incluida la inducción. Excelente conductividad térmica.
- Se puede lavar en el lavavajillas.
- Paelleras · Planchas: asas fabricadas en silicona de máxima calidad, termo aislantes, altamente resistentes y ergonómicas, permiten un agarre seguro de la piza.

FR

- Fabriquées en fonte d'aluminium de grande qualité et épaisseur, elles sont renforcées par particules à base de pierre et confère une résistance maximale aux rayures et à l'usure pour allonger la durée de vie.
- La base en aluminium permet une distribution homogène de la chaleur, permettant aux aliments de se cuire rapidement et de façon uniforme, sans à peine utiliser d'huile Leur antiadhésif.
- Tri-couche d'une qualité maximale et écologique, est sans PFOA.
- Intérieur et extérieur faciles à nettoyer grâce à la protection antiadhésive.
- Fond « FULL INDUCTION » compatible avec toutes les sources de chaleur, y compris l'induction. Excellente conductivité thermique.
- Peuvent être lavées au lave-vaisselle.
- Plat à paella · Planches : poignées fabriquées en silicone de la plus grande qualité, thermo-isolantes, hautement résistantes et ergonomiques, qui permettent de tenir l'ustensile en toute sécurité.

EN

- Made in high quality and thickness cast aluminium, it is reinforced with stone-based particles and maximum scratch and wear resistance and durability.
- The aluminium base allows for a homogeneous heat distribution, allowing the food to cook quickly and uniformly, without barely any oil.
- Its high quality and eco-friendly non-stick coating TRicapa is PFOA-free.
- Easy to clean interior and exterior with its non-stick protection.
- FULL INDUCTION base that can be used with all kinds of heat sources, including induction cookers. Excellent thermal conductivity.
- Dishwasher safe.
- Round dish · Grill plaque: heat insulating, highly resistant, ergonomic handles made of high quality silicone which provide a secure grip on pots and pans.



### Sartén

Poêle · Pfanne  
Frying pan · Sertä

Ref	€	ØD (cm)	Ød (cm)	h (cm)	e (mm)	U.Venta
24118	27,20	18	14,0	5,0	4,0	6
24120	30,90	20	14,5	5,0	4,0	6
24122	32,90	22	15,6	5,5	4,0	6
24124	35,70	24	17,4	6,0	4,0	6
24126	39,80	26	18,4	6,0	4,0	6
24128	42,30	28	20,5	6,0	4,0	6
24130	45,00	30	21,0	6,0	4,0	6



### Sartén Blinis

Poêle Blinis · Pfanne Blinis  
Frying pan Blinis · Sertä Blinis

Ref	€	ØD (cm)	Ød (cm)	h (cm)	e (mm)	U.Venta
24114	13,00	14	10,0	5,6	4,0	1



### Wok

Wok · Wok  
Wok · Wok

Ref	€	ØD (cm)	Ød (cm)	h (cm)	e (mm)	U.Venta
24138	43,00	28	16,0	9,0	4,0	1



### Crepera

Crêpière · Crêpes Pfanne  
Crepiere · Crepeira

Ref	€	ØD (cm)	Ød (cm)	h (cm)	e (mm)	U.Venta
24137	32,50	24	17,0	1,8	4,0	1
24136	36,10	26	18,0	1,8	4,0	1



### Grill

Grill · Grill  
Grill · Grelhador

Ref	€	cm	Ød (cm)	h (cm)	e (mm)	U.Venta
24123	37,10	24x24	16,7	4,5	4,0	1
24127	44,60	28x28	19,0	4,5	4,0	1
24125	37,20	24x24	16,7	4,5	4,0	1
24129	44,70	28x28	19,0	4,5	4,0	1



### Paellera

Plat à paella · Pfanne  
Round dish · Paelheira

Ref	€	ØD (cm)	Ød (cm)	h (cm)	Raciones	e (mm)	U.Venta
25432	74,50	32	25,5	4,5	5	1,6	1
25436	79,70	36	29,5	4,5	7	2,0	1
25440	93,00	40	33,5	4,5	9	2,0	1

Incluye asas de silicona  
Includes silicone handles



Fondo NO Full Induction  
NOT Full induction bottom

### Plancha Grill

Plaque à Grill · Platte Grill  
Grill plaque · Plancha Grill

Ref	€	Area cocción (cm)	ØBase (cm)	h (cm)	cm (Total)	e (mm)
25536	37,00	25,5x20	18,0	1,5	37,5x23x4,5	4,0
25547	51,30	33,5x25	21,0	2,0	47,5x29x5,5	4,0



### Plancha Grill

Plaque à Grill · Platte Grill  
Grill plaque · Plancha Grill

Ref	€	Area cocción (cm)	ØBase (cm)	h (cm)	cm (Total)	e (mm)	U.Venta
24134	65,10	33x25	24,0	2,0	46x27,5x6	4,0	1
24135	67,70	33x25	24,0	2,0	46x27,5x6	4,0	1

Si  
Silicone



### Asas para paellera ECO-PIEDRA

Poignées pour plat rond · Griffschutz for Pfanne  
Handles for round dish · Asas para paelheira

Ref	€	Ø (cm)	U.Venta
R25436A	11,60	32-36-40	1

Si  
Silicone



### Asas para plancha Grill

Poignées pour plaque à Grill · Griffschutz for Platte Grill  
Handles for grill plaque · Asas para plancha Grill

Ref	€	cm	U.Venta
R25736A	4,00	36	1
R25747A	5,60	47	1
R25536A	4,00	36	1
R25547A	5,60	47	1

# TitanFull

## Plancha grill



ES

- Fabricada en aluminio fundido de gran calidad.
- Diseñada para cocinar todo tipo de verduras, carnes, pescados, etc. de forma saludable y sin apenas utilizar aceite.
- Ahorro energético, hasta un 45% más eficiente, gracias a su fondo FULL INDUCTION.
- Distribución homogénea del calor: permite que los alimentos se cocinen rápidamente y de manera uniforme.
- Diseñada para uso doméstico y rendimiento profesional.
- Máxima resistencia al desgaste.
- Compatible con todo tipo de cocinas, incluida la inducción.

FR

- Fabriqué en fonte d'aluminium de grande qualité
- Conçue pour cuisiner tous types de légumes, viandes, poissons, etc. de façon saine et sans à peine utiliser d'huile.
- Économies d'énergie : jusqu'à 45% plus efficace grâce à son fond FULL INDUCTION rectangulaire.
- Distribution homogène de la chaleur : les aliments cuisent uniformément, sans à peine ajouter d'huile.
- Conçue aussi bien pour une utilisation professionnelle que domestique.
- Résistance maximale contre l'usure.
- Compatible avec tous types de feu, y compris l'induction.

EN

- Kitchen grill made of high quality very thick cast aluminium.
- Designed for cooking all kinds of vegetables, meat, fish, etc. in a healthy way with hardly any oil.
- Environmentally friendly and 100% PFOA free.
- Energy saving, up to 45% more efficient because of its rectangular FULL INDUCTION bottom.
- Even heat distribution: food can be cooked quickly and evenly with hardly any oil.
- Designed for home use and professional performance.
- Maximum wear resistance.
- Compatible with all kinds of cookers, including induction

Incluye asas de silicona  
Includes silicone handles



### Plancha Grill

Plaque à Grill · Platte Grill  
Grill plaque · Plancha Grill

Ref	€	Area cocción		U.Venta	
		(cm)	h (cm)		
24347	110,50	34x25	3	5,0	1

PPG Quantanium™  
Titanium-reinforced non-stick coating

- Antiadherente Quantanium® reforzado con partículas de titanio; libre de materiales tóxicos y pesados, ecológico y libre de PFOA.
- Antiadhésif Quantanium® renforcé avec des particules de titane ; sans matériaux toxiques ni métaux lourds, écologique et sans PFOA.
- Quantanium® non-stick reinforced with titanium particles; free from toxic and heavy materials, environmentally friendly and PFOA-free.

# SUA

## Sartén grill



ES

- Sartén parrilla grill fabricada en aluminio fundido de máxima calidad.
- Acabado antiadherente bicapa de alta calidad y 100% libre de PFOA. Libre de materiales tóxicos, pesados, disolventes y sustancias químicas.
- Diseñadas para una cocina saludable: permite cocinar sin apenas aceite garantizando que los alimentos no se peguen.
- Mango fabricado en madera de roble, totalmente plegable y ultrarresistente al calor.
- Máxima eficiencia y ahorro de energía; su fondo difusor FULL INDUCTION está especialmente diseñado para repartir el calor de manera rápida y uniforme a lo largo de toda la superficie (base + paredes), consiguiendo así que los alimentos se cocinen de forma uniforme por toda la superficie.
- Apta para todo tipo de fuegos: gas, eléctrica, vitrocerámica e inducción.

FR

- Poêle-grill fabriquée en fonte d'aluminium de la plus grande qualité.
- Finition antiadhésive bi-couche de grande qualité et 100% sans PFOA. Sans matériaux toxiques, métaux lourds, dissolvants ni substances chimiques.
- Conçue pour une cuisine saine : permet de cuisiner sans à peine utiliser d'huile en garantissant que les aliments ne collent pas.
- Manche fabriqué en chêne, entièrement pliable et ultra résistant à la chaleur.
- Efficacité et économies d'énergie maximales : son fond diffuseur FULL INDUCTION a été spécialement conçu pour répartir la chaleur de façon rapide et uniforme sur toute la surface (base + parois), obtenant ainsi une cuisson des aliments uniforme sur toute la surface.
- Apte pour tout type de cuisinières : gaz, électrique, vitrocéramique et induction.

EN

- Grill frying pan made of top quality cast aluminium.
- It has a high quality bi-layer non-stick coating that is 100% PFOA free. It's free of toxic materials, heavy metals, solvents and chemical substances.
- Designed for healthy cooking, it lets you cook with practically no oil with the assurance that food will not stick.
- It has a wooden handle that can be folded and is ultra heat resistant.
- Maximum efficiency and energy savings. The FULL INDUCTION diffuser bottom is specially designed to distribute heat quickly and evenly through the entire surface (base + sides). That means food is cooked evenly on the entire surface.
- It's suitable for all kinds of cookers: gas, electric, vitroceramic and induction.



### Grill

Grill · Grill Induktionfähig  
Grill · Grelhador

Ref	€	cm	Øh (cm)	e (mm)	U.Venta
25144	27,60	24x24	3,7	1,7	1
25148	33,60	28x28	3,8	1,7	1



### Grill liso

Grill lisse · Grill Induktionfähig, glatt  
Grill flat · Grelhador liso

Ref	€	cm	Øh (cm)	e (mm)	U.Venta
25154	27,60	24x24	3,7	1,7	1
25158	33,60	28x28	3,8	1,7	1

# JAVA

## Colección



### ES

- Fabricada en aluminio forjado de máxima calidad.
- Antiadherente interior y exterior reforzado a base de partículas de piedra.
- Ecológico, libre de materiales tóxicos y pesados. Libre de PFOA.
- Fondo FULL INDUCTION compatible con todas las fuentes de calor, incluida la inducción. Excelente conductividad térmica.

### FR

- Fabriquée en aluminium forgé de la plus grande qualité.
- Antiadhésif intérieur et extérieur renforcé à base de particules de pierre.
- Écologique, exempt de matériaux toxiques et lourds. Sans PFOA.
- Fond « FULL INDUCTION » compatible avec toutes les sources de chaleur, y compris l'induction. Excellente conductivité thermique.

### EN

- Made of high quality forged aluminum.
- Reinforced non-stick coating inside and outside using stone particles.
- Ecological, free of toxic and heavy materials. PFOA free.
- FULL INDUCTION base that can be used with all kinds of heat sources, including induction cookers. Excellent thermal conductivity.



**Sartén**  
Poêle · Pfanne  
Frying-pan · Sertā

Ref	€	ØD (cm)	Ød (cm)	h (cm)	e (mm)	U.Venta
26816	14,00	16	13,0	4,0	3,0	6
26818	15,00	18	13,8	4,0	3,0	6
26820	16,40	20	15,6	4,0	3,0	6
26822	18,50	22	17,4	4,5	3,0	6
26824	20,10	24	19,0	4,5	3,0	6
26826	22,20	26	20,4	5,0	3,0	6
26828	24,10	28	22,4	5,5	3,0	6
26830	26,80	30	23,7	5,5	3,0	6
26832	37,20	32	25,0	5,5	3,0	6



**Sartén honda**  
Poêle profonde · Tiefe Pfanne  
Deep frying-pan · Sertā funda

Ref	€	ØD (cm)	Ød (cm)	h (cm)	e (mm)	U.Venta
26834	21,40	24	18,5	6,5	3,0	1
26838	25,30	28	22,2	7,0	3,0	1



**Crepera**  
Crépière · Crêpes Pfanne  
Crepiere · Crepeira

Ref	€	ØD (cm)	Ød (cm)	h (cm)	e (mm)	U.Venta
26844	18,60	24	21,6	2,0	3,0	1



**Wok**  
Wok · Wok  
Wok · Wok

Ref	€	ØD (cm)	Ød (cm)	h (cm)	e (mm)	U.Venta
26848	23,80	28	17,0	8,0	3,0	1



**Grill**  
Grill · Grill Induktionfähig  
Grill · Grelhador

Ref	€	cm	Ød (cm)	h (cm)	e (mm)	U.Venta
26858	27,10	28 x 28	24,2	4,5	3,0	1

## FOGO Set

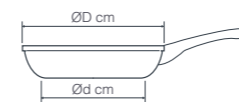

**Set 2 sartenes**

Set 2 poêles · Set 2 Bratpfannen  
Set 2 frying pans · Conjunto 2 sertās

Ref	€	ØD (cm)	Ød (cm)	h (cm)	e (mm)	U.Venta
26400	33,80	20	14,5	4,2	3,0	1
		24	18,0	4,7	3,0	



## VITE Sartén

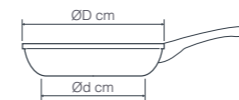

26718

**Sartén VITE**  
Poêle · Pfanne  
Frying pan · Sertā

Ref	€	ØD (cm)	Ød (cm)	h (cm)	e (mm)	U.Venta
26718	12,40	18	11,5	4,0	3,0	6
26720	13,90	20	14,3	4,0	3,0	6
26722	15,80	22	15,6	4,5	3,0	6
26724	17,40	24	17,0	4,5	3,0	6
26726	19,90	26	19,0	5,0	3,0	6
26728	22,00	28	21,5	5,0	3,0	6
26730	23,70	30	21,2	5,5	3,0	6





# EASY Sartén



## ES

- Fabricada en aluminio forjado de máxima calidad.
- Recubrimiento antiadherente Whitford reforzado de máxima calidad y libre de PFOA.
- Antiadherente interior reforzado a base de partículas de piedra.
- Fondo FULL INDUCTION compatible con todas las fuentes de calor, incluida la inducción. Excelente conductividad térmica.

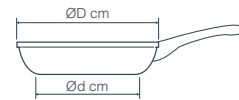

**Sartén**  
Poêle · Pflanne  
Frying-pan · Sertã

Ref	€	ØD (cm)	h (cm)	e (mm)	U.Venta
27018	20,50	18	4,0	3,0	6
27020	21,30	20	4,0	3,0	6
27022	23,10	22	4,5	3,0	6
27024	25,00	24	4,5	3,0	6
27026	27,20	26	5,0	3,0	6
27028	29,80	28	5,5	3,0	6
27030	32,60	30	5,5	3,0	6
27032	34,50	32	6,0	3,0	6

## FR

- Fabriquée en aluminium forgé de la plus grande qualité.
- Revêtement antiadhésif renforcé Whitford de qualité supérieure et sans PFOA.
- Antiadhésif intérieur renforcé à base de particules de pierre.
- Fond « FULL INDUCTION » compatible avec toutes les sources de chaleur, y compris l'induction. Excellente conductivité thermique.

## EN

- Made of high quality forged aluminum.
- Top quality Whitford reinforced non-stick coating and PFOA-free.
- Reinforced non-stick coating inside using stone particles.
- FULL INDUCTION base that can be used with all kinds of heat sources, including induction cookers. Excellent thermal conductivity.

**Mango de fundición de acero inoxidable**  
Cast stainless steel handle



# FIT Sartén



## ES

- Gracias al tratamiento electrolítico empleado en su proceso de fabricación, el aluminio se sella completamente y se endurece para que no pase a los alimentos.
- Gran durabilidad y ultrarresistente: superficie robusta altamente resistente a roces, deformación y corrosión.

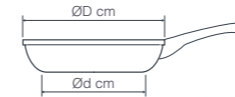

**Sartén**  
Poêle · Pflanne  
Frying pan · Sertã

Ref	€	ØD (cm)	Ød (cm)	h (cm)	L	e (mm)	U.Venta
48720	32,30	20	15,0	4,0	0,90	4,5	6
48724	40,40	24	18,0	4,5	1,50	4,5	6
48728	48,20	28	22,0	5,0	2,70	4,5	6

## FR

- Grâce au traitement électrolytique utilisé lors de son processus de fabrication, l'aluminium est totalement scellé et durcit pour ne pas pouvoir atteindre les aliments.
- Grande durabilité et ultra résistante : Surface robuste hautement résistante aux rayures, à la déformation et à la corrosion.

## EN

- Because of the electrolytic treatment used in the manufacturing process, the aluminium is completely sealed and hardened so no metal is passed on to the food.
- Extremely durable and ultra-high strength: It has a robust surface that is highly resistant to abrasion, warping and corrosion.

**PPG Quantanium**  
Titanium-reinforced non-stick coating

- Antiadherente QuanTanium® reforzado con partículas de titanio; libre de materiales tóxicos y pesados, ecológico y libre de PFOA.
- Antiadhésif QuanTanium® renforcé avec des particules de titane ; sans matériaux toxiques ni métaux lourds, écologique et sans PFOA.
- QuanTanium® non-stick reinforced with titanium particles; free from toxic and heavy materials, environmentally friendly and PFOA-free.

# VOGA Sartén



## ES

- Fabricado en aluminio forjado, acabado fuerte y robusto.
- Calentamiento rápido y uniforme.
- Recubrimiento antiadherente ILAG:ULTIMATE (Tricapa) de gran calidad ultrarresistente y de uso intensivo.
- Mango de acero inoxidable, no se calienta.

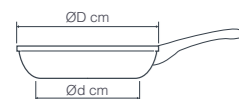

**Sartén**  
Poêle · Pflanne  
Frying-pan · Sertã

Ref	€	ØD (cm)	Ød (cm)	h (cm)	e (mm)	U.Venta
24720	32,50	20	14,6	4,5	4,0	6
24722	35,50	22	15,6	5,0	4,0	6
24724	39,80	24	17,7	5,0	4,0	6
24726	44,00	26	18,8	5,5	4,0	6
24728	47,10	28	20,4	6,0	4,0	6
24732	54,90	32	23,3	6,5	4,0	6

## FR

- Fabriquée en aluminium forgé, finition solide et robuste.
- Chauffe rapide et uniforme.
- Revêtement antiadhésif ILAG:ULTIMATE (tri-couche) de grande qualité ultra résistant et à usage intensif.
- Manche en acier inoxydable, ne chauffe pas.

## EN

- Made of forged aluminium, strong and robust finish.
- Quick and even heating.
- Ultra-resistant high-quality ILAG:ULTIMATE non-stick coating (Triple-layer) for intensive use.
- Heat-resistant stainless steel handle.



# LOFT Sartén



## ES

- Fabricada en aluminio embutido, acabado fuerte y robusto.
- Recubrimiento antiadherente. Calidad y larga duración.
- Exterior en negro mate.
- Calentamiento rápido y uniforme.
- Mango SOFT TOUCH.



**Sartén**  
Poêle · Pflanne  
Frying pan · Sertã

Ref	€	ØD (cm)	Ød (cm)	h (cm)	e (mm)	U.Venta
24918	18,90	18	13,5	3,8	3,5	6
24920	20,70	20	14,7	4,3	3,5	6
24922	22,30	22	16,5	4,3	3,5	6
24924	24,90	24	17,6	4,8	3,5	6
24926	26,60	26	19,0	4,8	3,5	6
24928	30,70	28	22,1	5,3	3,5	6

## FR

- Fabriquée en aluminium embouti, finition forte et robuste.
- Revêtement antiadhésif. Qualité et longue durée de vie.
- Extérieur en noir mat.
- Chauffe rapide et uniforme.
- Manche SOFT TOUCH.

## EN

- Made from deep drawn aluminium, strong and robust finish.
- Non-stick coating. Quality and long life.
- Outside in matte black.
- Quick and uniform heating.
- SOFT TOUCH handle.

**Mango SOFT TOUCH**  
SOFT TOUCH handle



# TRIMETAL

## Colección



### ES

- **Cuerpo fabricado en 3 capas: acero inoxidable 18/10, aluminio, acero inoxidable 18%.**
- **La capa exterior, es de acero inoxidable con componentes ferríticos, lo que la convierte totalmente compatible con las cocinas de inducción.**
- **Los mangos están fabricados en acero inoxidable 18/10 y recubiertas con un protector térmico de silicona para facilitar un agarre perfecto y seguro.**

### FR

- Corps fabriqué avec 3 couches : acier inoxydable 18/10, aluminium, acier inoxydable 18%.
- La couche extérieure est en acier inoxydable avec des composants ferritiques, ce qui lui permet d'être totalement compatible avec les cuisinières à induction.
- Les manches sont fabriqués en acier inoxydable 18/10 et recouverts d'une protection thermique en silicone pour faciliter une prise en main parfaite et sûre.

### EN

- Body manufactured in a 3-layered: 18/19 stainless steel, aluminium, 18% stainless steel.
- Exterior layer, of stainless steel with ferrite materials, making it completely compatible with induction cookers.
- The grips are made in 18/10 stainless steel and covered in a silicon heat protection for easy and safe gripping.



**Sartén**  
Poêle · Pflanne  
Frying pan · Sertä

Ref	€	Ø (cm)	h (cm)	e (mm)	U.Venta
53720	57,80	20	4,5	2,3	1
53724	64,40	24	5,0	2,3	1
53728	78,90	28	5,5	2,3	1



**Sartén antiadherente**  
Poêle antiadherent · Pflanne, Antihaft  
Non-stick frying pan · Sertä anti-aderente

Ref	€	Ø (cm)	h (cm)	e (mm)	U.Venta
53721	68,00	20	4,5	2,3	1
53725	81,40	24	5,0	2,3	1
53729	102,80	28	5,5	2,3	1



**Wok**  
Wok · Wok  
Wok · Wok

Ref	€	Ø (cm)	h (cm)	e (mm)	U.Venta
53828	85,80	28	8,0	2,3	1



**Wok antiadherente**  
Wok, Antiadherent · Wok, Antihalt  
Wok, non-stick · Wok anti-aderente

Ref	€	Ø (cm)	h (cm)	e (mm)	U.Venta
53829	97,50	28	8,0	2,3	1

# TRICHEF

## Colección



### ES

- **El aluminio interior garantiza una distribución rápida y uniforme del calor, así como un importante ahorro en el uso de la energía.**
- **Mango ergonómico fabricado en fundición de acero inoxidable 18/10 de gran calidad.**
- **Apta para todo tipo de cocinas, especialmente para la inducción.**
- **Máxima garantía en cuanto a resistencia, durabilidad e higiene.**
- **Apto para el horno (hasta 260°) y lavavajillas.**

### FR

- L'aluminium intérieur garantit une distribution rapide et uniforme de chaleur, ainsi que d'importantes économies d'énergie.
- Poignée ergonomique fabriquée en fonte d'acier inoxydable 18/10 de grande qualité.
- Apte pour tous types de cuisinières, particulièrement l'induction.
- Garantie maximale en termes de résistance, durabilité et hygiène.
- Apte pour le four (jusqu'à 260°C) et le lave-vaisselle.

### EN

- The aluminium layer inside ensures fast, even heat distribution to the food and significant energy saving costs.
- Ergonomic handle made of high quality 18/10 cast stainless steel.
- Suitable for all hobs, especially induction.
- Maximum guarantee in terms of strength, durability and hygiene.
- Oven (up to 260°) and dishwasher safe.

## New

- 1.- Acero inoxidable 18/10 · 18/10 stainless steel
- 2.- Aluminio · Aluminium
- 3.- Acero inoxidable inducción · Induction stainless steel

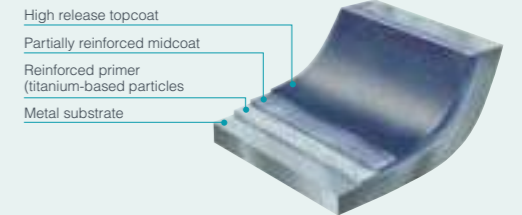
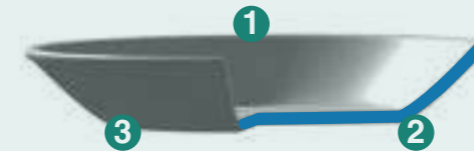

- **El aluminio interior garantiza una distribución rápida y uniforme del calor, así como un importante ahorro en el uso de la energía.**
- **Asas ergonómicas fabricadas en fundición de acero inoxidable 18/10 de gran calidad.**
- **Aptas para todo tipo de cocinas, especialmente para la inducción.**
- **Máxima garantía en cuanto a resistencia, durabilidad e higiene.**
- **Aptas para el horno (hasta 260°C) y lavavajillas.**

- **Antiadherente Quantanium® reforzado con partículas de titanio; libre de materiales tóxicos y pesados, ecológico y libre de PFOA.**
- Antiadhésif Quantanium® renforcé avec des particules de titane ; sans matériaux toxiques ni métaux lourds, écologique et sans PFOA.
- Quantanium® non-stick reinforced with titanium particles; free from toxic and heavy materials, environmentally friendly and PFOA-free.

- The aluminium layer inside ensures fast, even heat distribution to the food and significant energy saving costs.
- Ergonomic handles made of high quality 18/10 cast stainless steel.
- Suitable for all hobs, especially induction.
- Maximum guarantee in terms of strength, durability and hygiene.
- Oven (up to 260°) and dishwasher safe.



**Sartén**  
Poêle · Pflanne  
Frying pan · Sertä

Ref	€	Ø (cm)	h (cm)	e (mm)	U.Venta
60850	30,90	20	4,3	2,5	1
60854	38,60	24	4,8	2,5	1
60858	46,80	28	5,3	2,5	1



**Sartén antiadherente**  
Poêle antiadherent · Pflanne, Antihaft  
Non-stick frying pan · Sertä anti-aderente

Ref	€	Ø (cm)	h (cm)	e (mm)	U.Venta
60950	36,50	20	4,3	2,5	1
60954	44,80	24	4,8	2,5	1
60958	54,70	28	5,3	2,5	1

# INOX 18/10

## Colección



### ES

- Fabricadas en acero inoxidable 18/10 de la mejor calidad.
- Máxima garantía en resistencia, durabilidad e higiene.
- Fondo termodifusor sandwich, distribución rápida y uniforme del calor.
- Homogeneidad y eficacia térmica.
- Cocción ultrarrápida.
- Aptas para todos los fuegos.

### FR

- Fabriquées en acier inoxydable 18/10 de la meilleure qualité.
- Garantie maximale de résistance, de durabilité et d'hygiène.
- Fond thermo-diffuseur sandwich, distribution rapide et uniforme de la chaleur.
- Homogénéité et efficacité thermique.
- Cuisson ultra-rapide.
- Aptes pour tous les feux.

### EN

- Made of 18/10 stainless steel of the best quality.
- Maximum guarantee in resistance, durability and hygiene.
- Heat-diffusing sandwiched base, quick and even heat distribution.
- Thermal homogeneity and efficiency.
- Ultra-rapid cooking.
- Suitable for all types of cookers.

### Sartén VITROCOR

Poêle · Pfanne  
Frying pan · Sertä

Ref	€	Ø (cm)	h (cm)	e (mm)	U.Venta
40619	32,90	18	4,5	0,7	1
40621	35,00	20	4,5	0,7	1
40623	36,30	22	5,0	0,7	1
40625	38,80	24	5,2	0,7	1
40627	40,00	26	6,0	0,7	1
40629	42,90	28	6,5	0,7	1



### Sartén lisa HOME

Poêle, lisse · Pfanne, glatt  
Frying-pan flat · Sertä

Ref	€	Ø (cm)	h (cm)	e (mm)	U.Venta
71318	37,90	18	5,5	0,7	1
71320	39,80	20	5,5	0,7	1
71322	44,30	22	5,5	0,7	1
71324	48,50	24	6,0	0,7	1
71326	53,30	26	6,0	0,7	1
71328	59,80	28	6,5	0,7	1

### Sartén HOME

Poêle · Pfanne  
Frying-pan · Sertä

Ref	€	Ø (cm)	h (cm)	e (mm)	U.Venta
71818	37,90	18	5,5	0,7	1
71820	39,80	20	5,5	0,7	1
71822	44,30	22	5,5	0,7	1
71824	48,50	24	6,0	0,7	1
71826	53,30	26	6,0	0,7	1
71828	59,80	28	6,5	0,7	1

## New

### Mango

Poignée · Griff  
Handle · Cabo

Ref	€	Color	U.Venta
A 56601	14,20	Negro · Black	1
B 56605	14,40	Azul · Blue	1
C 56603	14,40	Rojo · Red	1



### Cuerpo para tartera/sartén COMBI

Corps pourplat rond/poêle · Körper für Pfanne/Pfanne  
Body for round dish/frying pan · Corpo para tarteira/sertä

Ref	€	Ø (cm)	h (cm)	L	U.Venta
56720	23,70	20	4,0	1,00	1
56724	29,40	24	4,5	2,00	1
56728	39,90	28	5,0	3,00	1
56732	47,60	32	5,5	4,00	1



### Cuerpo para tartera/sartén COMBI

Corps pourplat rond/poêle · Körper für Pfanne/Pfanne  
Body for round dish/frying pan · Corpo para tarteira/sertä

Ref	€	Ø (cm)	h (cm)	L	U.Venta
56820	30,90	20	4,0	1,00	1
56824	37,40	24	4,5	2,00	1
56828	49,70	28	5,0	3,00	1
56832	57,70	32	5,5	4,00	1



### Sartén FOODIE

Poêle · Pfanne  
Frying pan · Sertä

Ref	€	ØD (cm)	Ød (cm)	h (cm)	e (mm)	U.Venta
45420	29,60	20	13,5	5,5	0,6	1
45422	31,50	22	14,5	5,5	0,6	1 <b>New</b>
45424	35,30	24	17,5	6,0	0,6	1
45426	37,50	26	19,0	6,0	0,6	1 <b>New</b>
45428	41,50	28	19,5	6,5	0,6	1
45430	42,70	30	22,0	6,5	0,6	1 <b>New</b>



### Sartén antiadherente FOODIE

Poêle antiadherent · Pfanne, Antihafit  
Frying-pan, non-stick · Sertä anti-aderente

Ref	€	ØD (cm)	Ød (cm)	h (cm)	e (mm)	U.Venta
45320	34,80	20	13,5	5,5	0,6	1
45322	36,10	22	14,5	5,0	0,6	1 <b>New</b>
45324	42,60	24	17,5	6,0	0,6	1
45326	43,70	26	19,0	6,0	0,6	1 <b>New</b>
45328	51,00	28	19,5	6,5	0,6	1
45330	52,20	30	22,0	6,5	0,6	1 <b>New</b>

## New



### Sartén ORIGIN

Poêle · Pfanne  
Frying pan · Sertä

Ref	€	ØD (cm)	Ød (cm)	h (cm)	e (mm)	U.Venta
47318	24,30	18	12,5	4,00	0,6	1
47320	27,10	20	12,8	4,20	0,6	1
47322	29,20	22	16,8	4,40	0,6	1
47324	31,10	24	18,5	4,60	0,6	1
47328	34,80	28	21,2	4,80	0,6	1
47330	37,80	30	23,0	5,00	0,6	1



### Sartén antiadherente ORIGIN

Poêle antiadherent · Pfanne, Antihafit  
Frying-pan, non-stick · Sertä anti-aderente

Ref	€	ØD (cm)	Ød (cm)	h (cm)	e (mm)	U.Venta
47418	28,80	18	12,5	4,00	0,6	1
47420	31,90	20	12,8	4,20	0,6	1
47422	34,30	22	16,8	4,40	0,6	1
47424	36,50	24	18,5	4,60	0,6	1
47428	41,40	28	21,2	4,80	0,6	1
47430	45,10	30	23,0	5,00	0,6	1

# INOX 18/10

## Rustideras

Inox  
18/10



### ES

- Gran calidad, resistencia, tamaño y capacidad, muy útiles en la cocina.
- Ideales para la cocción de platos y asados al horno.
- Soportan sin problemas temperaturas altas.
- Excelente resistencia a la corrosión y a los ácidos alimentarios y sales.
- Asas atérmicas.

### FR

- Grande qualité, robustesse, taille et capacité, très utiles dans la cuisine.
- Idéal pour la cuisson de plats et de rôtis au four.
- Supporte sans problèmes des températures élevées.
- Excellente résistance à la corrosion et aux sels et acides alimentaires.
- Poignées athermiques.

### EN

- Great quality, durability, size and capacity, very useful in the kitchen.
- Ideal for cooking dishes and roasts in the oven.
- Easily withstands high temperatures.
- Excellent resistance to corrosion and to food acids and salts.
- Heat-resistant handles.



### Rustidera

Plat à rotir · Lasagneform  
Roaster " Assadeira

Ref	€	cm	h (cm)	U.Venta
62530	32,80	30x21	5,5	1
62535	43,30	35x26	5,5	1
62540	55,10	40x31	6,0	1



### Rustidera CHEF-INOX

Plat à rotir · Lasagneform  
Roaster · Assadeira

Ref	€	cm	h (cm)	e (mm)	U.Venta
50540	115,20	40x30	8,0	1,0	1
50550	152,60	50x40	8,0	1,0	1
50560	192,20	60x45	8,0	1,0	1
50570	219,60	70x45	9,5	1,0	1



Inox

### Rustidera asas abatibles

Plat à gratin anse tombante · Bratpfanne mit Fallgriffen  
Roaster moving handles · Assadeira asa abatível

Ref	€	cm	h (cm)	U.Venta
61530	15,90	30x22	5,0	1
61535	20,20	35x26	6,0	1
61540	25,80	40x28	6,5	1
61545	38,20	45x32	7,5	1
61550	71,10	50x36	8,0	1



### Rustidera honda asas abatibles

Plat à rotir anse tombante · Bratpfanne mit Fallgriffen  
Roaster moving handles · Assadeira funda asa abatível

Ref	€	cm	h (cm)	U.Venta
62530A	36,30	30x22	7,5	1
62535A	44,20	35x26	8,0	1
62540A	52,60	40x28	8,0	1
62545A	61,00	45x32	9,0	1

New

Rejilla extraíble  
Removable rack



Inox

### Bandeja con rejilla ESSENTIAL

Plat à four avec grille · Backblech mit Gitter  
Tray with rack · Bandeja com grelha

Ref	€	cm	h (cm)	U.Venta
15562	9,90	21,5x15	2,0	1
15563	12,30	23,5x15,5	2,5	1
15566	15,10	26,5x20,5	2,5	1

- Bandeja con rejilla extraíble fabricada en acero inoxidable de gran calidad.
- Borde de acero encapsulado reforzado que evita la deformación.
- Alta conductividad térmica: distribuye el calor de manera uniforme proporcionando resultados de cocción óptimos.
- Funcional y versátil: Con la rejilla podrás asar todo tipo de carnes, enfriar galletas, deshidratar frutas, etc. Sin la rejilla, podrás estofar guisos, asar todo tipo de verduras incluso hornear tu bizcocho favorito.
- Apta para el horno, frigorífico y congelador.

- Plat à four avec grille amovible fabriqué en acier inoxydable de grande qualité.
- Bord en acier encapsulé renforcé qui évite la déformation.
- Haute conductivité thermique : distribue la chaleur de façon uniforme en apportant des résultats de cuisson optimums.
- Fonctionnel et versatile : le plat avec la grille vous permet de rôtir tout type de viandes, refroidir des biscuits, déshydrater des fruits, etc. Le plat sans la grille vous permet de préparer des ragoûts, de griller tout type de légumes, et même de faire cuire votre gâteau préféré.
- Apte pour le four, le réfrigérateur et le congélateur.

- High quality stainless steel tray with removable rack.
- Reinforced encapsulated steel rim to prevent warping.
- High thermal conductivity for even heat distribution and optimum cooking results.
- Highly functional and versatile: use the rack to roast all kinds of meat, to cool biscuits, dehydrate fruit, etc., or remove it to make casseroles, roast all kinds of vegetables and even bake your own favourite sponge cake!
- Oven, fridge and freezer safe

Rustideras - Horno  
Roasting pans - Oven

# ALUMINIO

## Rustideras



### ES

- Rustideras fabricadas en aluminio de máxima calidad.
- Distribución homogénea del calor por toda la superficie.
- Recubrimiento antiadherente de gran calidad, resistente a arañazos y ralladuras.
- Ecológico, libre de materiales tóxicos y pesados. Libre de PFOA.
- Robustas y resistentes a la deformaciones y a la abrasión.
- Ideal para hornear y gratinar todo tipo de alimentos.
- Asas diseñadas para un agarre seguro y cómodo.
- Fácil de limpiar.

### FR

- Plat à rôtir fabriqué en aluminium de la plus grande qualité.
- Distribution homogène de la chaleur sur toute la surface.
- Revêtement antiadhésif de grande qualité, résistant aux rayures.
- Écologique, sans matériaux toxiques ni métaux lourds. Sans PFOA.
- Finition intérieure et extérieure noir mat.
- Robuste et résistant à la déformation et à l'abrasion.
- Idéal pour une utilisation au four et pour gratiner tout type d'aliments.
- Poignées conçues pour une prise en mains sûre et pratique.
- Facile à nettoyer.

### EN

- The roasting tin is made of top quality aluminium.
- Heat is distributed evenly over the entire surface.
- It has a high quality non-stick coating that is scratch and scrape resistant.
- It's environmentally friendly and free of toxic materials and heavy metals. It's PFOA free.
- The inside and outside have a matte black finish.
- It's sturdy and resists warping and scratches.
- It's perfect for baking and cooking all kinds of foods au gratin.
- The handles are designed for a safe and comfortable grip.
- It's easy to clean.

**Asa de tubo de acero inoxidable 18/10**  
Handles in a 18/10 stainless steel tube

**Aluminio puro (99,5%)**  
Made in pure (99.5%) aluminium



### Rustidera con asas fijas

Plat à rotir anse fixe · Bratpfanne m. feststehenden Griffen  
Roaster fix handle · Assadeira com asa fixa

Ref	€	cm	h (cm)	e (mm)	L	U.Venta
20540F	53,90	40x30	6,2	2,5	7,45	1
20545F	57,80	45x32	6,2	2,5	10,40	1
20550F	72,60	50x35	7,0	3,0	12,60	1
20555F	78,80	55x37	7,7	3,0	16,30	1
20560F	85,30	60x40	7,7	3,0	18,95	1
20565F	94,80	65x43	7,9	3,0	24,30	1
20570F	100,30	70x45	9,0	3,0	28,65	1

### Rustidera con asas abatibles

Plat à rotir anse tombante · Bratpfanne mit Fallgriffen  
Roaster moving handle · Assadeira com asa abatível

Ref	€	cm	h (cm)	e (mm)	L	U.Venta
20540A	53,90	40x30	6,2	2,5	7,45	1
20545A	57,80	45x32	6,2	2,5	10,40	1
20550A	72,60	50x35	7,0	3,0	12,60	1
20555A	78,80	55x37	7,7	3,0	16,30	1
20560A	84,70	60x40	7,7	3,0	18,95	1
20565A	94,80	65x43	7,9	3,0	24,30	1
20570A	100,30	70x45	9,0	3,0	28,65	1



**Fondo Full Induction**  
Full Induction bottom

### Rustidera aluminio fundido antiadherente

Plat à gratin en aluminium fondu, antiadherent · Bratpfanne, Aluminium, Antihaf  
Aluminium cast roaster, non-stick · Assadeira alumínio fundido anti-aderente

Ref	€	cm	h (cm)	U.Venta
25534	60,40	34x28	8	1



### Rustidera antiadherente INTENSE

Plat à rotir antiadherent · Lasagneform, AntihafNon-stick  
roasterAssadeira anti-aderente

Ref	€	cm	h (cm)	e (mm)	U.Venta
15720	14,20	20x15	4,7	1,50	1
15725	16,90	25x19	5,0	1,95	1
15730	22,80	30x22	5,7	3,00	1
15735	30,80	35x26	6,3	4,50	1

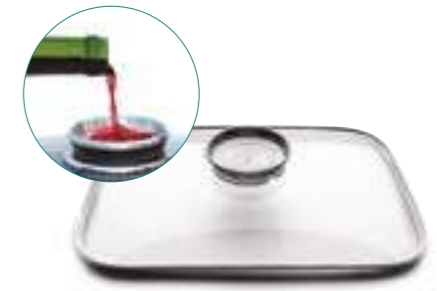

\* Para la rustidera 25534 · For the 25534 roaster

### Tapa de cristal rustidera

Couvercle en verre pour plat à rôtir · Deckel Glas für Bratpfanne  
Lid glass for roaster · Tampa de vidro para assadeira

Ref	€	cm	h (cm)	U.Venta
25539	14,60	34x28	8	1



### Rustidera antiadherente con asas abatibles ROBUST

Plat à rotir a/tombante, antiadherent · Bratpfanne mit Fallgriffen, Aluminium, Antihaf  
Roaster Robust moving handle, non-stick · Assadeira c/asa abatível anti-aderente

Ref	€	cm	h (cm)	U.Venta
23540A	61,60	40x30	6,2	1
23550A	75,00	50x35	7,0	1

## New



### Bandeja MASTER

Plateau · Platte  
Tray · Bandeja

Ref	€	cm	h (cm)	U.Venta
68465	23,10	45x33	5,0	1
68466	24,10	53x38	2,5	1

- **Calidad premium:** Fabricada en aluminio natural; 99,5% de pureza.
- **Garantiza una conductividad térmica superior, con una distribución homogénea del calor permitiendo así que todas las elaboraciones se doren y se horneen de forma uniforme.**
- **Especialmente diseñadas para profesionales de la repostería, cocinas exigentes y de alta producción.**
- **Ligera, resistente e indeformable, fácil manejo.**
- **Limpieza:** Se recomienda lavarla a mano con un jabón y una esponja no abrasivos. No apto para el lavavajillas.
- **Consejos de uso:** se recomienda usar tanto papel / tapete para hornear.

- **Qualité premium :** Fabriqué en aluminium naturel ; 99,5% de pureté.
- **Garantit une conductivité thermique supérieure avec une distribution homogène de la chaleur, permettant ainsi à toutes les préparations culinaires de dorer et cuire de façon uniforme.**
- **Spécialement conçu pour les professionnels de la pâtisserie, les cuisines exigeantes et de grande production.**
- **Léger, résistant et indéformable ; facile à manipuler.**
- **Nettoyage :** il est recommandé de le laver à la main avec du savon et une éponge non abrasifs. Ne peut pas aller au lave-vaisselle.
- **Conseils d'utilisation :** il est recommandé d'utiliser du papier sulfurisé ou un tapis de cuisson pour cuire les aliments.

- **Premium quality:** made from 99.5% pure natural aluminium.
- **Guarantees excellent thermal conductivity and homogeneous heat distribution, allowing all baked goods to brown and bake evenly.**
- **Specially designed for professional bakers, demanding chefs and busy, high output kitchens.**
- **Lightweight, robust, non-deformable and easy to handle.**
- **Cleaning:** cleaning by hand with detergent and a non-abrasive sponge is recommended. Not dishwasher safe.
- **Instructions for use:** baking mats and baking paper are both recommended.

# HORNO

Parrillas · Placas · Pinzas



Inox



## Parrilla

Grille · Gitter, Rost  
Grate · Grelha

Ref	€	cm	h (cm)	U.Venta
68741	29,80	60x40	0,8	1

Inox



## Parrilla

Grille · Gitter, Rost  
Grate · Grelha

Ref	€	cm	Cubeta	U.Venta
66920	53,60	65X53	2/1	1
66921	20,60	53X32,5	1/1	1

AL



## Placa horno aluminio antiadherente

Plaque à four aluminium anti-adhésif teflon · Backblech, Aluminium, Teflon  
Teflon non-stick coated oven aluminium tray · Placa forno alumínio anti-aderente

Ref	€	cm	h (cm)	U.Venta
68660	37,20	60x40	1,0	1
68659	33,80	GN 1/1	1,0	1

Fe



## Placa horno acero negro

Plaque à four toile noire · Backblech, Schwarzstahl  
Baking sheet black steel · Placa de forno aço negro

Ref	€	cm	h (cm)	U.Venta
68640	36,60	60x40	0,8	1

Inox



## Placa horno

Plaque à four · Backblech  
Baking sheet · Placa de forno

Ref	€	cm	h (cm)	U.Venta
68740	44,20	60x40	0,8	1
68739	34,20	GN 1/1	0,8	1

AL



## Placa horno

Plaque à four · Backblech  
Baking sheet · Placa de forno

Ref	€	cm	h (cm)	U.Venta
68641	34,70	60x40	0,8	1
68642	28,00	GN 1/1	0,8	1



## Pinza para horno y bandeja GN

Pince inox pour bac Gastronorm · Zange für GN Behälter  
Tong GN tray · Pinça para forno e bandejas GN

Ref	€	L (cm)	U.Venta
A 62989	17,00	20	12
B 62998	17,00	20	12

Con silicona · With silicone

# HORNO

Cordel · Tapetes · Láminas



RAYÓN 80 m

- Fabricado en rayón.
- Para bridar, albardar, atar asados y rellenos.
- Con soporte de almacenaje.
- Apto para horno. Temperatura max. 230°C

- Fabriqué en rayonne.
- Pour ficeler, barder, attacher les rôtis et les aliments farcis.
- Avec support de stockage.
- Convient pour le four. Température max. 230°C

- Made of Rayon.
- For tying, wrapping and trussing roasts and stuffing.
- With storage support.
- Oven safe. max temperature 230°C.



## Cordel cocina

Fil de cuisine · Küchenschnur  
Kitchen string · Fio de cozinha

Ref	€	m	U.Venta
61414	6,00	80	6

- Incluye · Includes:
- 1.- Tablas de conversión de temperatura (°C / °F)
  - 2.- Peso (gr / oz)
  - 3.- Volumen ml / floz / pt)
  - 4.- Longitud (mm / inch)
  - 5.- Reglas laterales (cm / inch)

Flexible, antiadherente y reutilizable  
Flexible, non-stick and reusable

Flexible, antiadherente y reutilizable  
Flexible, non-stick and reusable



## Tapete de silicona impreso

Tapis en silicone imprime · Bedruckte Silikonmatte  
Printed silicon mat · Tapete de silicone impreso

Ref	€	cm	U.Venta
66759	28,90	60x40	1

## Tapete de silicona

Tapis en silicone · Backblech-Auflage Silikon  
Silicone covering · Tapete de silicone

Ref	€	cm	U.Venta
66749	20,30	30x40	1
66731	28,10	60x40	1
66732	20,80	52x32 GN 1/1	1



Fácil de cortar  
Easy to cut

3 pcs

## Láminas antiadherentes

Feuilles antiadhésif · Antihaf-Blätter  
Non-stick sheets · Láminas antiaderentes

Ref	€	cm	unidades	U.Venta
66746	9,80	30x40	3	1



- Láminas de fibra de vidrio con recubrimiento antiadherente de gran calidad.
- Ideal para colocar sobre bandejas o parrillas de hornos y deshidratadores.
- Vida útil aproximadamente de 1000 hornados.
- Diseñadas para soportar temperaturas de hasta 250°C.
- Recortable para adaptar a cualquier recipiente.
- Reutilizables, para una correcta conservación se recomienda su lavado a mano.
- No aptas para el lavavajillas.

- Fiberglass sheets with non-stick coating high-quality.
- Ideal for placing on baking trays, oven racks and dehydrators.
- Can be used approximately 1,000 times.
- Designed to withstand temperatures up to 250°C.
- Can be cut to fit any container.
- Reusable; in order to keep the sheets in good condition, we recommend washing by hand.
- Non-dishwasher safe.

# GUANTES DE COCINA

## Colección



ES

- Materiales de alta calidad y una alta protección contra el calor por contacto.
- Permite manipular todo tipo de utensilios de cocina con total seguridad.
- Combina la resistencia al calor con la flexibilidad y comodidad.
- Manga que cubre la mayor parte del antebrazo.

FR

- Matériaux de grande qualité et une haute protection contre la chaleur pour contacts.
- Permet de manipuler tout type d'ustensiles de cuisine en toute sécurité.
- Allie la résistance à la chaleur à la flexibilité et le confort.
- Manche qui recouvre une grande partie de l'avant-bras.

EN

- High quality materials and excellent heat protection by contact.
- Lets you handle all kinds of cooking utensils with complete safety.
- Combines heat resistance with flexibility and the comfort.
- The sleeve covers most of your forearm.

New



Capa de algodón 100% adicional en el interior que aumenta la comodidad y la durabilidad  
Additional 100% cotton layer inside. Provides comfort and durability



### Guante de cocina RED

Gant de cuisine · Küchenhandschuh  
Kitchen glove · Luva de cozinha

Ref	€	L (cm)	U.Venta
60034	12,90	27	1

New



2 pcs

### Guante de cocina UNIVERSAL

Gant de cuisine · Küchenhandschuh  
Kitchen glove · Luva de cozinha

Ref	€	L (cm)	U.Venta
A 60062	34,70	32	1
B 60068	37,70	48	1



### Guante de cocina SAFE

Gant de cuisine · Küchenhandschuh  
Kitchen glove · Luva de cozinha

Ref	€	L (cm)	U.Venta
61034	10,10	32	6



### Guante de cocina SALVE

Gant de cuisine · Küchenhandschuh  
Kitchen glove · Luva de cozinha

Ref	€	L (cm)	U.Venta
61033	22,30	33	1



### Guante cocina textil

Gant de cuisine en cotton · Küchenhandschuh, Baumwolle  
Gray kitchen cotton · Luva de cozinha de algodão

Ref	€	L (cm)	U.Venta
60070	12,50	36	1

### Guante algodón aluminizado

Gant de cuisine coton aluminisé · Küchehandschuh, Baumwolle, Aluminisierte  
Aluminized cotton oven glove · Luva de cozinha de algodão alumínio

Ref	€	L (cm)	U.Venta
A 61024	6,00	24	1
B 61030	7,10	30	1
C 61036	7,70	36	1



ES

- Seguridad máxima: resistencia a las fuertes temperaturas.
- Presión asegurada: ranuras antideslizantes.
- Manejable: exterior del guante de silicona flexible.
- Forro interior de algodón amovible lavable (60041).
- Práctica anilla para colgar. Ambidiestro.
- Fácil de lavar y desinfectar.

FR

- Sécurité maximum: résistance aux fortes températures.
- Préhension: sécurisée: rainures antidérapantes.
- Maniabl: extérieur du gant en silicone flexible.
- Doublure en coton amovible (60041).
- Pratique anneau de suspension. Ambidextre.
- Facile à laver et désinfecter.

EN

- Maximum safety: withstands extremely high temperatures.
- Safe grip: non-slip grooves.
- Easy to handle: exterior of the glove in flexible silicone. Removable cotton lining (60041).
- Practical hanging ring. Fits both hands.
- Easy to wash and disinfect.



Forro interior de algodón extraíble lavable  
Removable cotton lining



No utilizar por separado  
Do not use the glove separately

### Guante de cocina ORKA-TEX

Gant de cuisine · Küchenhandschuh  
Kitchen glove · Luva de cozinha

Ref	€	L (cm)	U.Venta
60041	31,20	29	12



### Guante de cocina ORKA

Gant de cuisine · Küchenhandschuh  
Kitchen glove · Luva de cozinha

Ref	€	L (cm)	U.Venta
A 60010	37,10	29	1
B 60011	60,80	42	1

# HORNO

## Protectores



### Protector de silicona

Protection en silicone · Silikonschutz  
Silicone handle cover · Protector de silicone

Ref	€	L (cm)	U.Venta
23900	6,40	13,5	1



### Manopla de silicona

Mouflette en silicone · Fäustling aus Silikon  
Silicone mitten · Pegas de silicone

Ref	€	U.Venta
60014	9,90	6



### Cubre asas

Couvre les poignées · Griffschutz  
Covers handles · Pegas cobre-asas

Ref	€	Ø (cm)	U.Venta
R25917G	8,20	16	6
R25921G	7,80	20-24-28	6
R25933G	8,20	26x20	6
R25935G	7,80	31x25	6

- Mango protector de silicona de alta calidad para sartenes.
- Fácil de colocar, se ajusta perfectamente al mango de la sartén.
- Antideslizante y termorresistente, protege de las temperaturas elevadas.
- Compatible con nuestras sartenes Robust, Ferrum, Dynamic y Tricapa Plus (Ø16-32 cm).

- High quality protective silicone handle for frying pans.
- Easy to put on, it fits the pan handle perfectly.
- Non-slip and heat-resistant, it protects from high temperatures.
- Compatible with our Ferrum, Robust, Dynamic and Tricapa Plus frying pans (Ø16-32 cm).



### Cubre asas ECO-PIEDRA

Couvre les poignées · Griffschutz  
Covers handles · Pegas cobre-asas

Ref	€	Ø (cm)	U.Venta
R25436A	11,60	32-36-40	1



### Asas para plancha grill

Poignées pour plaque à grill · Griffschutz for Platte Grill  
Handles for grill plaque · Asas para plancha grill

Ref	€	cm	U.Venta
R25536A	4,00	36	1
R25547A	5,60	47	1



Personalización para cantidades  
Personnalisation pour des quantités  
Customization for quantities

>500 ud.



### Delantal de algodón

Tablier en coton · Schürze, Baumwolle  
Cotton pinafore · Avental de algodão

Ref	€	U.Venta
10004	12,00	1



### Cubre asas TITANIUM

Couvre les poignées · Griffschutz  
Covers handles · Pegas cobre-asas

Ref	€	Ø (cm)	U.Venta
R27520A	4,30	20	1
R27528A	4,40	24-28	1
R27732A	5,50	32-36	1



### Asas para plancha grill

Poignées pour plaque à grill · Griffschutz for Platte Grill  
Handles for grill plaque · Asas para plancha grill

Ref	€	cm	U.Venta
R25736A	4,00	36	1
R25747A	5,60	47	1

# PARIS · MILAN · LIMA

## Colección



ES

- Permiten manipular todo tipo de utensilios de cocina con total seguridad.
- Combinan la resistencia al calor con la flexibilidad y comodidad del algodón.
- Guantes con manga que cubre la mayor parte del antebrazo.
- Práctica presilla para colgarlo en la cocina.
- Delantales de gran calidad con bolsillo inferior dividido en dos partes. Unisex. Talla única ajustable.

Paris  
Collection



### Colección PARIS

Collection · Kollektion  
Collection · Coleção

	Ref	€	cm	U.Venta
A	60080	13,50	68x83	1
B	60037	5,50	30	1
C	60044	4,30	20x20	1



FR

- Ils permettent de manipuler tous les types d'ustensiles de cuisine en toute sécurité.
- Ils allient la résistance à la chaleur à la souplesse et au confort du coton.
- Gants dont la manche couvre la majeure partie de l'avant-bras.
- Boucle pratique à suspendre dans la cuisine.
- Tabliers de haute qualité avec poche inférieure divisée en deux parties. Unisex. Taille unique réglable.

Milan  
Collection



### Colección MILAN

Collection · Kollektion  
Collection · Coleção

	Ref	€	cm	U.Venta
A	60081	11,20	68x83	1
B	60038	5,00	30	1
C	60045	3,90	20x20	1



EN

- For safely handling all types of kitchen utensils.
- Perfectly heat resistant together with the flexibility and comfort of cotton.
- Gloves featuring a sleeve that covers most of the forearm.
- Practical clip for hanging in the kitchen.
- Top-quality aprons featuring a bottom pocket divided into two parts. Unisex. One size fits all (adjustable).

Lima  
Collection



### Colección LIMA

Collection · Kollektion  
Collection · Coleção

	Ref	€	cm	U.Venta
A	60082	8,90	68x83	1
B	60039	4,70	30	1
C	60046	3,50	20x20	1



# PROTECCIÓN

## Guantes · Delantal

**Composición · Composition:**  
62% Polietileno / 62% Polyethylene  
24% Poliéster / 24% Polyester  
14% Fibra de vidrio / 14% Glass fiber



2 pcs

### Guante protección

Gant de protection · Schutzhandschuh  
Protection glove · Luva de protecção

Ref	€	Talla	Medida	Perim. mano	L (cm)	U.Venta
61101	19,50	M	8	182 mm	24	1
61102	19,50	L	9	192 mm	25	1
61103	19,50	XL	10	204 mm	26	1

Guantes certificados según regulación EPI EU 2016/425 módulo B  
Gloves certified according to regulation EPI EU 2016/425 module B



NO lavable · NOT washable

EN 388:2016+1:2018



344 XC

CE certificate issued by CTC FRANCE

Resistencia a la abrasión  
Abrasion resistance **3**

Resistencia al corte  
Blade cut resistance **4**

Resistencia al PDM  
PDM resistance **C**

Resistencia al desgarro  
Tear resistance **4**

- Ambidiestros, cómodo y ligero.
- **NO emplear con sierras giratorias o dentadas.**

- Ambidextres, pratiques et légers.
- NE PAS utiliser avec des scies giratoires ou dentées.

- Ambidextrous, comfortable and light.
- Do NOT use with rotating or toothed saws.

Inox



### Guante cota

Gant en maille · Netz-Handschuh  
Chainmail glove · Luva de malha

Ref	€	Talla	Medidas	Perim. mano	Color	U.Venta
39169	139,10	S	7	171 mm	Blanco/White	1
39170	139,10	M	8	182 mm	Rojo/Red	1
39171	139,10	L	9	192 mm	Azul/Blue	1
39172	139,10	XL	10	204 mm	Naranja/Orange	1



UNE EN 1082

CE Directive 89/686/EEC and EN 1082-1-1996

- Guante cinco dedos con correa en la muñeca.
- Reversible para mano derecha como izquierda.
- Diseño de correa extraíble y protección completa de mano.
- Fácil lavar y desinfectar.

- Gant cinq doigts avec courroie au poignet.
- Réversible pour main droite ou gauche.
- Conception de courroie extractible et protection complète de la main.
- Facile à laver et désinfecter.

- Five-finger glove with strap on the wrist.
- Reversible for both right and left hand.
- Detachable strap and complete hand protection design.
- Easy to wash and disinfect.

Ideal para uso en mandolinas profesionales  
Ideal for use in professional mandolins

Inox



### Delantal cota de malla

Tablier en maille · Kettenhemb Schürze  
Metal butcher's apron · Avental de malha

Ref	€	cm	Perímetro	U.Venta
39165	322,40	80x55	95-145 cm	1

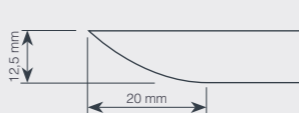

UNE EN 1082

EN ISO 13998: 2003  
NIVEL / LEVEL: 2

- Ajustable gracias a sus tirantes verticales y horizontales.
- Conviene asegurarse de que las medidas del cuchillo empleado no sean inferiores a:

- Ajustable grâce à ses bandes verticales et horizontales.
- Il convient de s'assurer que les dimensions du couteau utilisé ne sont pas inférieures à :

- Adjustable thanks to its vertical and horizontal straps.
- Care must be taken to ensure that the knife used does not measure less than:

# RELOJES DE COCINA

## Colección



ES

- Gracias a su parte posterior magnética podrá colocar el reloj de cocina en cualquier parte metálica de su cocina.
- Alarma acústica programable.

FR

- Grâce à sa partie arrière magnétique, le minuteur peut être placé sur n'importe quelle partie métallique de la cuisine.
- Alarme acoustique programmable.

EN

- Thanks to the magnet on the back, the kitchen timer can be placed on any metal surface in the kitchen.
- Programmable acoustics alarm.

IP65 12/24 Horas



Magnético  
Magnet

### Reloj de cocina con alarma

Minuteur de Cuisine avec Alarme · Küchen-Zeitschaltuhr mit Alarm  
Kitchen Timer Alarm · Relógio de cozinha com alarme

Ref	€	cm	U.Venta
60804	38,90	13x24,5x2,5	1



Magnético  
Magnet

### Reloj digital de cocina con avisador acústico

Minuter Électronique · Digitale Küchen-Zeitschaltuhr mit Alarm  
Digital kitchen timer w/alarm · Relógio digital de cozinha com alarme acústico

Ref	€	cm	U.Venta
60805	9,00	10,5x7	1

Magnético  
Magnet



### Reloj de cocina magnético

Minuteur de cuisine magnetique · Magnetküchentimer  
Magnetic kitchen timer · Relógio de cozinha magnetico

Ref	€	Tiempo	cm	U.Venta
60803	10,80	60 min	9,2x3,5	1

24 Horas



Soporte plegable. Potente imán  
Folding stand. Powerful magnet



### Reloj de cocina con alarma

Minuteur de Cuisine avec Alarme · Küchen-Zeitschaltuhr mit Alarm  
Kitchen Timer Alarm · Relógio de cozinha com alarme

Ref	€	cm	U.Venta
60802	19,60	7x1,4x5,1	1

# INOXIDABLE Paelleras

Inox 18/10

Sandwich Vitro Electric Gas Induction Oven Dishwasher



## Paellera con tapa CHEF-LUXE

Plat rond avec couvercle · Pfanne mit Deckel  
Round dish with lid · Paelheira com tampa

Ref	€	Ø (cm)	h (cm)	e (mm)	L	U.Venta
54636	169,50	36	7,0	1,5	7,00	1
54640	206,30	40	8,0	1,5	10,00	1
54645	238,90	45	8,5	2,0	12,00	1
* 54650	301,50	50	9,0	2,0	17,00	1

\* NO inducción · NON induction · NOT induction



## Paellera sin tapa CHEF-LUXE

Plat rond s/couvercle · Pfanne ohne Deckel  
Round dish without lid · Paelheira sem tampa

Ref	€	Ø (cm)	U.Venta
54636S	134,10	36	1
54640S	166,30	40	1
54645S	193,00	45	1
* 54650S	246,80	50	1

\* NO inducción · NON induction · NOT induction



## Paellera con tapa CHEF-CLASSIC

Plat rond a/couvercle · Pfanne mit Deckel  
Round with lid · Paelheira com tampa

Ref	€	Ø (cm)	h (cm)	e (mm)	L	U.Venta
50624	63,00	24	6,0	0,8	2,70	1
50628	85,20	28	6,0	0,8	3,60	1
50632	110,20	32	6,0	0,8	5,00	1
50636	139,30	36	7,0	1,0	7,10	1
50640	160,60	40	8,0	1,0	10,00	1
50645	188,60	45	8,5	1,0	13,50	1
50650	244,60	50	9,0	1,0	17,60	1
* 50660	353,80	60	9,0	1,0	25,40	1

\* NO inducción · NON induction · NOT induction



## Paellera sin tapa CHEF-CLASSIC

Plat rond s/couvercle · Pfanne ohne Deckel  
Round dish without lid · Paelheira sem tampa

Ref	€	Ø (cm)	U.Venta
50624S	48,30	24	1
50628S	68,40	28	1
50632S	87,80	32	1
50636S	112,50	36	1
50640S	130,20	40	1
50645S	152,30	45	1
50650S	200,10	50	1
* 50660S	295,50	60	1

\* NO inducción · NON induction · NOT induction



## Paellera sin tapa WAGNER

Plat rond s/couvercle · Pfanne ohne Deckel  
Round dish without lid · Paelheira sem tampa

Ref	€	Ø (cm)	h (cm)	e (mm)	L	U.Venta
50624W	50,70	24	6,0	0,8	2,70	1
50628W	67,30	28	6,0	0,8	3,60	1
50632W	83,50	32	6,0	0,8	5,00	1
50636W	113,50	36	7,0	1,0	7,10	1
50640W	129,80	40	8,0	1,0	10,00	1
50645W	149,50	45	8,5	1,0	13,50	1
50650W	202,20	50	9,0	1,0	17,60	1
* 50660W	288,00	60	9,0	1,0	25,40	1

\* NO inducción · NOT induction



## Paellera sin tapa ECO-CHEF

Plat rond sans couvercle · Pfanne ohne Deckel  
Round without lid · Paelheira sem tampa

Ref	€	Ø (cm)	h (cm)	e (mm)	L	U.Venta
57624	37,70	24	6,5	0,8	3,00	1
57628	52,20	28	6,5	0,8	4,00	1
57632	66,70	32	7,0	0,8	5,00	1
57636	91,80	36	7,0	1,0	7,10	1
57640	105,80	40	8,0	1,0	10,00	1

Paelleras  
Paella pans



### Paellera Valenciana antiadherente

Plat à paella anti-adhésif · Paellapfanne, Antihaft  
Round dish for paella non-stick · Paelheira valenciana anti-aderente

Ref	€	Ø (cm)	Raciones	U.Venta
60232	77,00	32	5	1
60236	91,00	36	7	1
60240	110,00	40	9	1



Mantiene el diseño de las paelleras clásicas y elegantes  
Maintains the classic and elegant paella pan design



### Paellera Valenciana

Plat à paella · Paellapfanne  
Round dish for paella · Paelheira valenciana

Ref	€	Ø (cm)	Raciones	U.Venta
60130	61,80	30	4	1
60134	74,40	34	6	1
60138	88,50	38	8	1
60142	108,10	42	10	1
60146	128,50	46	12	1
60150	166,40	50	14	1
60155	211,80	55	16	1
60160	263,30	60	18	1

## New

- 1.- Acero inoxidable 18/10 · 18/10 stainless steel
- 2.- Aluminio · Aluminium
- 3.- Acero inoxidable inducción · Induction stainless steel

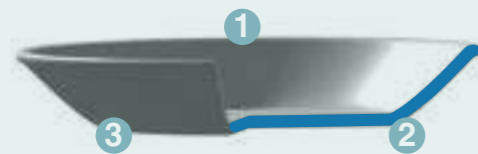

- El aluminio interior garantiza una distribución rápida y uniforme del calor, así como un importante ahorro en el uso de la energía.
- Asas ergonómicas fabricadas en fundición de acero inoxidable 18/10 de gran calidad.
- Aptas para todo tipo de cocinas, especialmente para la inducción.
- Máxima garantía en cuanto a resistencia, durabilidad e higiene.
- Aptas para el horno (hasta 260°C) y lavavajillas.

- The aluminium layer inside ensures fast, even heat distribution to the food and significant energy saving costs.
- Ergonomic handles made of high quality 18/10 cast stainless steel.
- Suitable for all hobs, especially induction.
- Maximum guarantee in terms of strength, durability and hygiene.
- Oven (up to 260°) and dishwasher safe.



### Paellera TRICHEF

Plat à paella · Pfanne  
Round dish · Paelheira

Ref	€	Ø (cm)	ØBase (cm)	h (mm)	Raciones	U.Venta
60834	43,50	34	25	5,0	5	1
60840	54,60	40	30	6,0	6	1

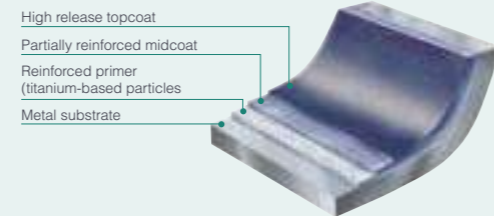

- Antiadherente QuanTanium® reforzado con partículas de titanio; libre de materiales tóxicos y pesados, ecológico y libre de PFOA.
- Antiadhésif QuanTanium® renforcé avec des particules de titane ; sans matériaux toxiques ni métaux lourds, écologique et sans PFOA.
- QuanTanium® non-stick reinforced with titanium particles; free from toxic and heavy materials, environmentally friendly and PFOA-free.



### Paellera TRICHEF

Plat à paella · Pfanne  
Round dish · Paelheira

Ref	€	Ø (cm)	ØBase (cm)	h (mm)	Raciones	U.Venta
60833	56,40	34	25	5,0	5	1
60839	71,30	40	30	6,0	6	1

# ALUMINIO Paelleras



### Paellera ECO-PIEDRA BLACK

Plat à paella · Pfanne  
Round dish · Paelheira

Ref	€	ØD (cm)	Ød (cm)	h (cm)	Raciones	e (mm)	U.Venta
25432	74,50	32	25,5	4,5	5	1,6	1
25436	79,70	36	29,5	4,5	7	2,0	1
25440	93,00	40	33,5	4,5	9	2,0	1



### Asas para paellera ECO-PIEDRA

Poignées pour plat rond · Griffschutz für Pfanne  
Handles for round dish · Asas para paelheira

Ref	€	Ø (cm)	U.Venta
R25436A	11,60	32-36-40	1

Incluye asas de silicona  
Includes silicone handles



### Paellera COCOTTE

Plat rond · Pfanne  
Round · Paelheira

Ref	€	ØD (cm)	Ød (cm)	h (cm)	e (mm)	Raciones	U.Venta
25932	82,10	32	25,5	4,5	1,6	5	1
25936	95,90	36	29,5	4,5	2,0	7	1
25940	106,60	40	33,5	4,5	2,0	9	1



- Fabricadas en aluminio fundido de gran calidad y espesor, reforzadas con partículas a base de piedra y una máxima resistencia al rayado, duración y desgaste.
- Distribución homogénea del calor, permitiendo que los alimentos se cocinen rápidamente y de manera uniforme, sin apenas utilizar aceite.
- Antiadherente TRICapa de máxima calidad y ecológico. Libre de PFOA.
- Fácil limpieza interior y exterior gracias a protección antiadherente.
- Aptas para todo tipo de fuegos y se puede lavar en el lavavajillas.
- Asas fabricadas en silicona de máxima calidad, termoaislantes, altamente resistentes y ergonómicas, permiten un agarre seguro en la pieza.

- Fabriquées en fonte d'aluminium de grande qualité et épaisseur, elles sont renforcées par particules à base de pierre et confère une résistance maximale aux rayures et à l'usure pour allonger la durée de vie.
- Distribution homogène de la chaleur, permettant aux aliments de se cuire rapidement et de façon uniforme, sans à peine utiliser d'huile.
- Antiadhésif Tri-couche d'une qualité maximale et écologique, est sans PFOA.
- Intérieur et extérieur faciles à nettoyer grâce à la protection antiadhésive.
- Compatibles avec tout type de feux et peuvent être lavées au lave-vaisselle.
- Poignées fabriquées en silicone de la plus grande qualité, thermo-isolantes, hautement résistantes et ergonomiques, qui permettent de tenir l'ustensile en toute sécurité.

- Made in high quality and thickness cast aluminium, it is reinforced with stone-based particles and maximum scratch and wear resistance and durability.
- Allows for a homogeneous heat distribution, allowing the food to cook quickly and uniformly, without barely any oil.
- Its high quality and eco-friendly non-stick coating TRICapa is PFOA-free.
- Easy to clean interior and exterior with its non-stick protection.
- Suitable for all range cookers and they are dishwasher safe.
- Heat insulating, highly resistant, ergonomic handles made of high quality silicone which provide a secure grip on pots and pans.

- Garantizan la absorción y distribución uniforme del calor, sin puntos de sobrecalentamiento.
- La distribución del calor uniforme por toda la pieza hace que los alimentos no pierdan su jugo durante la cocción, conservando así todos sus nutrientes y vitaminas.
- Fondo difusor FULL INDUCTION; asegura un rendimiento óptimo en todo tipo de cocinas, con un reparto de calor inmejorable logrando la máxima eficiencia y ahorro de energía.
- Perfectas para arroces, carnes, pescados, legumbres, verduras, guisos, cremas, salsas, sopas, etc.
- Revestimiento antiadherente Xylan Plus.
- Diseño atractivo y funcional.
- Compatibles con todo tipo de cocinas, incluida la inducción.

- Garantit l'absorption et la distribution uniforme de la chaleur, sans points de surchauffe.
- La répartition uniforme de la chaleur dans toute la pièce signifie que les aliments ne perdent pas leur jus pendant la cuisson, préservant ainsi tous leurs nutriments et vitamines.
- Fond diffuseur FULL INDUCTION; garantit un rendement optimal sur tout type de feux, avec une répartition de la chaleur unique, obtenant ainsi une efficacité et une économie d'énergie maximales.
- Parfait pour le riz, la viande, le poisson, les légumineuses, légumes, ragoûts, crèmes, sauces, soupes, etc.
- Revêtement antiadhésif Xylan Plus.
- Conception attrayante et fonctionnelle.
- Compatible avec tout type de feux, y compris l'induction.

- It guarantees the absorption and uniform distribution of heat, without overheating points.
- The uniform distribution of heat throughout the product makes keep its juices during cooking, preserving all its nutrients and vitamins.
- The FULL INDUCTION diffuser bottom ensures optimal performance on all kinds of cookers with unbeatable heat distribution that achieves maximum efficiency and energy savings.
- Ideal product for: rice, meats, fish, beans, vegetables, stews, creams, sauces, soups, etc.
- Non-stick coating Xylan Plus.
- Attractive design and great functionality.
- It's compatible with all kinds of cookers, including induction.



### Paellera CHEF-ALUM.

Plat rond · Pflanne  
Round · Paelheira

Ref	€	Ø (cm)	h (cm)	e (mm)	L	U.Venta
20628	41,80	28	7,0	2,5	4,30	1
20630	44,40	30	6,5	2,5	4,75	1
20632	47,50	32	7,0	2,5	5,50	1
20634	50,20	34	7,0	2,5	6,35	1
20636	53,10	36	7,5	2,5	7,45	1
20638	53,90	38	7,5	2,5	8,60	1
20640	63,40	40	8,0	3,0	10,05	1
20645	69,30	45	8,0	3,0	12,50	1
20650	80,80	50	8,0	3,5	15,50	1
20660	115,50	60	10,0	4,5	28,00	1



### Paellera ROBUST

Plat rond · Paellapfanne  
Round dish · Paelheira

Ref	€	Ø (cm)	h (cm)	U.Venta
23724	22,80	24	4,00	1
23728	29,90	28	4,50	1
23732	35,20	32	5,00	1
23736	42,50	36	5,50	1
23740	52,60	40	6,00	1



### Paellera antiadherente STEEL

Plat à paella, antiadhésive · Paellapfanne, Antihaf  
Round dish for paella, non stick · Paelheira anti-aderente

Ref	€	Ø (cm)	Raciones	U.Venta
60127	21,80	28	3	1
60131	24,60	32	5	1
60135	28,50	36	7	1
60139	32,00	40	9	1
60144	42,70	45	12	1
60149	51,60	50	14	1
60159	65,40	60	19	1

Esmalte vitrificado  
Vitrified enamel



### Paellera SMALT

Plat à paella · Paellapfanne, emailliert  
Round dish for paella · Paelheira esmaltada

Ref	€	Ø (cm)	Raciones	U.Venta
60170	5,10	10	1	10
60172	5,70	12	1	10
60175	6,70	15	1	6
60180	8,60	20	1	6
60184	10,40	24	1	1
60188	12,70	28	3	1
60182	17,40	32	5	1
60186	19,50	36	7	1
60141	24,00	40	9	1
60151	36,80	50	14	1
60161	57,90	60	19	1

# MASTER Paelleras



### Paellera STEEL PRO

Plat à paella · Paellapfanne  
Round dish for paella · Paelheira

Ref	€	Ø (cm)	h (cm)	Raciones	U.Venta
63621	6,70	20	4,0	1	6
63623	6,80	22	3,5	1	6
63625	7,10	24	3,7	1	6
63627	7,80	26	3,7	2	6
63629	8,10	28	4,1	3	6
63631	8,80	30	4,2	4	6
63633	9,80	32	5,0	5	6
63635	10,60	34	4,6	6	6
63637	11,40	36	5,0	7	1
63639	12,80	38	5,0	8	1
63641	13,90	40	5,0	9	1
63643	16,00	42	5,0	10	1
63647	18,00	46	5,0	12	1
63651	21,40	50	5,5	14	1
63656	35,00	55	5,5	16	1
63661	41,40	60	5,0	19	1
63666	51,30	65	5,5	22	1
63671	73,00	70	6,0	25	1
63681	100,30	80	7,1	40	1
63691	140,10	90	8,0	50	1
63115	417,60	115	9,0	120	1
63130	867,10	130	12,0	200	1

Con 4 asas  
With 4 handles

Con 6 asas  
With 6 handles



- Clásicas paelleras fabricadas en acero.
- Máxima garantía en cuanto a resistencia, durabilidad e higiene.
- Ideales para eventos, catering y fiestas populares.
- Aptas para cocina de gas, vitrocerámica, eléctrica.
- Disponible en diferentes diámetros.

- Poêles à paella classiques en acier.
- Garantie maximale en termes de résistance, durabilité et hygiène.
- Idéal pour les événements, la restauration et les fêtes populaires.
- Convient aux cuisinières à gaz, vitrocéramiques et électriques.
- Disponible en différents diamètres.

- Classic paella pans made of steel.
- Maximum guarantee in terms of resistance, durability and hygiene.
- Ideal for events, catering and popular parties.
- Suitable for Gas, Vitroceramic, Electric cookers.
- Available in different diameters.

Asas de acero inoxidable  
Stainless steel handles



### Paellera FERRUM

Plat à paella · Paellapfanne  
Round dish for paella · Paelheira

Ref	€	Ø (cm)	h (cm)	e (mm)	Raciones	U.Venta
63928	57,10	28	4,5	2,5	3	1
63932	64,70	32	4,7	2,5	5	1
63936	80,70	36	5,5	2,5	7	1
63940	88,90	40	5,5	2,5	9	1

## Accesorios para paelleras

Diseñado para el soporte paellero ref.: 63700  
Designed for base for burner



### Paellero Gas Butano

Rechaud · Brenner  
Burner · Paelheira gás butanos

Ref	€	Ø (cm)	Quemadores	Kw	Presión (mbar)	U.Venta	Paelleras recomendadas
63731	46,70	30	1	6,50	37	1	Ø36-38-40-42-46
63741	80,80	20-40	2	11,40	37	1	Ø28-30-32-34-36-46-50-55
63751	106,80	30-50	2	14,10	37	1	Ø38-40-42-46-60-65-70
63761	150,40	20-40-60	3	21,00	37	1	Ø28-30-32-34-36-46-50-55-70-80
63771	247,20	30-50-70	3	24,50	37	1	Ø38-40-42-46-60-65-70-80-90

Válido para propano y butano · NO válidas Gas Natural y Gas Ciudad  
Valid for propane and butane · NOT valid Natural Gas and Gas City

Regulable para distintas medidas  
Adjustable for different measures



### Soporte paellero

Pied pour rechaud · Stände für Brenner  
Base for burner · Cuporte paelheira

Ref	€	U.Venta
63700	46,30	1



# U.P. Colección

Inox  
Dishwasher

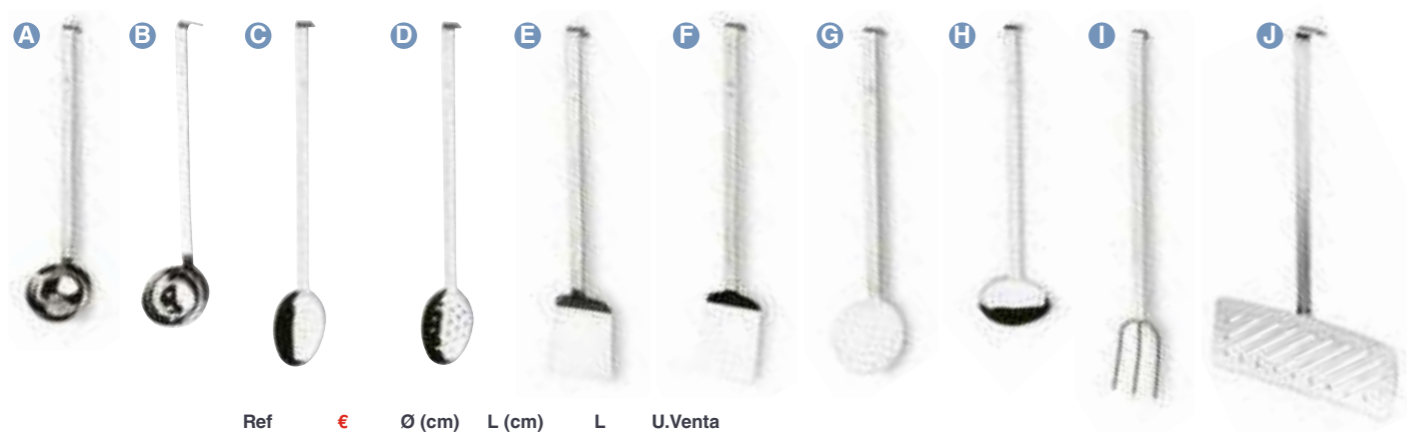

	Ref	€	Ø (cm)	L (cm)	L	U.Venta	
	60306	10,20	6,50	34,5	0,07	6	<b>Cacillo</b> · Louche · Ladle
	60308	11,70	8,00	38,0	0,12	6	
	60309	12,40	9,00	46,0	0,20	6	
<b>A</b>	60310	14,00	10,00	46,0	0,25	6	
	60312	16,40	12,00	48,0	0,50	6	
	60314	21,10	14,00	55,0	0,75	6	
	60316	21,80	16,00	55,5	1,00	6	
	61308	11,00	8	38,0	0,12	6	<b>Cacillo perforado</b> · Louche perforée · Perfored ladle
	61310	14,20	10	46,0	0,25	6	
	61312	16,90	12	48,0	0,50	1	
<b>B</b>	60507	11,00	10,5	48,0	-	1	<b>Cuchara</b> · Cuillère · Ladle
<b>C</b>	60508	13,30	7,50	48,0	-	6	<b>Cuchara perforada</b> · Cuillère perforee · Perforated ladle
<b>D</b>	61410	12,30	9x10	49,5	-	6	<b>Espátula</b> · Spatule · Spatula
<b>E</b>	61412	13,90	11x12	51,0	-	6	
<b>F</b>	61411	13,20	9x10	49,50	-	6	<b>Espátula perforada</b> · Spatule perforee · Perforated spatule
	61413	14,40	11x12	51,0	-	6	
	60408	9,70	8	35,0	-	1	<b>Espumadera</b> · Ecumoire · Skimmer
	60410	11,70	10	47,0	-	6	
<b>G</b>	60412	12,30	12	49,5	-	6	
	60414	16,40	14	57,0	-	6	
	60416	18,00	16	57,0	-	6	
<b>H</b>	60509	14,40	8x10	45,0	0,07	1	<b>Cuchara oblicua</b> · Cuillère oblique · Crosswire spoon
<b>I</b>	60002	15,40	7x8	57,5	2 puntas	6	<b>Tenedor</b> · Fourchette · Fork
	60003	17,10	7x13	7x13	3 puntas	6	
<b>J</b>	62988	19,90	20,5x8	37,0	12	12	<b>Paleta de pescado</b> · Pelle à poisson · Fish turner



### Espumadera alambre

Ecumoire etamee · Fritierschaufel  
Tinned skimmer · Escumadeira de arame

Ref	€	Ø (cm)	L (cm)	U.Venta
63514	11,90	14	54,0	1
63516	12,70	16	56,5	1
63518	13,10	18	56,5	1
63520	16,30	20	67,0	1
63524	18,00	24	70,5	1
63528	21,30	28	76,0	1

**Alambre estañado** · Fil étamé · Tinned wire



### Espumadera alambre

Ecumoire à friture · Fritierlöffel  
Skimmer · Escumadeira arame

Ref	€	Ø (cm)	L (cm)	U.Venta
60409	12,80	10	47,0	6
60411	13,90	12	49,0	6
60413	16,70	14	50,5	6
60415	18,40	16	52,0	6
60417	21,70	18	58,0	6
60419	25,90	20	59,0	6
60423	32,70	24	71,5	6
60427	38,30	28	74,0	6



### Rasera alambre

Araignée à fil · Fritierlöffel  
Mesh skimmer · Escumadeira arame

Ref	€	Ø (cm)	L (cm)	U.Venta
67410	13,90	10	37,0	6
67412	18,90	12	44,0	6
67415	30,30	15	55,5	6
67417	35,30	17	56,0	6
67420	43,30	20	58,0	6

Inox  
18/10

# BUFFET Colección

Inox  
18/10  
Dishwasher



	Ref	€	cm	L (cm)	U.Venta	
<b>A</b>	72853	11,30	Ø6	24,5	6	<b>Cacillo</b> · Louche · Ladle
<b>B</b>	72857	10,40	5x8	27,5	6	<b>Cuchara</b> · Cuillère · Ladle
<b>C</b>	72858	10,40	5x8	27,5	6	<b>Cuchara perforada</b> · Cuillère perforee · Perforated ladle
<b>D</b>	72854	12,60	Ø8	27,0	6	<b>Espumadera</b> · Ecumoire · Skimmer
<b>E</b>	72859	11,30	7x9	28,5	6	<b>Espátula perforada</b> · Spatule perforee · Perforated spatule
<b>F</b>	72850	11,30	5x7,5	23,5	6	<b>Cacillo salsa</b> · Louche sauce · Gravy ladle
<b>G</b>	72851	10,80	6x8,5	28,0	6	<b>Pala ensalada</b> · Pelle à salade · Dalat scoop
<b>H</b>	72856	11,30	6,5x11	31,5	6	<b>Pala pastel</b> · Pelete à gâteau · Cake scoop
<b>I</b>	72855	9,20	4,5x9	28,5	6	<b>Tenedor</b> · Fourchette · Fork

# PROFESIONAL Colección

Inox  
18/10  
Dishwasher



	Ref	€	cm	L (cm)	U.Venta	
<b>A</b>	72803	20,70	Ø10	37,0	6	<b>Cacillo</b> · Louche · Ladle
<b>B</b>	72807	15,40	7x11	36,0	6	<b>Cuchara</b> · Cuillère · Ladle
<b>C</b>	72808	15,70	7x11	35,5	6	<b>Cuchara perforada</b> · Cuillère perforee · Perforated ladle
<b>D</b>	72806	14,90	9x12	35,0	6	<b>Espátula</b> · Spatule · Spatula
<b>E</b>	72809	16,70	9x12	39,0	6	<b>Espátula perforada</b> · Spatule perforee · Perforated spatule
<b>F</b>	72804	17,20	Ø11	37,0	6	<b>Espumadera</b> · Ecumoire · Skimmer
<b>G</b>	72805	14,00	3x10	35,5	6	<b>Tenedor</b> · Fourchette · Fork
<b>H</b>	72810	15,60	Ø6,5	29,0	6	<b>Cacillo salsa</b> · Louche sauce · Gravy ladle
<b>I</b>	72811	16,10	6,5x9	34,0	6	<b>Servidor espaguetis</b> · Cuillère à spaguetis · Spaguetti server

# SUPER MONOBLOCK

## Colección

Inox 18/10  
Dishwasher



	Ref	€	cm	L (cm)	U.Venta	
A	62603	16,80	Ø10	31,0	6	Cacillo · Louche · Ladle
B	62609	14,70	7x9	31,0	1	Cacillo salsa · Louche sauce · Gravy ladle
C	62607	12,60	7x10	32,0	6	Cuchara · Cuillière · Ladle
D	62608	11,80	7x10	32,0	1	Cuchara perforada · Cuillière perforee · Perforated ladle
E	62604	16,80	Ø11	36,5	6	Espumadera · Ecumoire · Skimmer
F	62606	12,30	8x9	33,5	6	Espátula · Spatule · Spatula
G	62605	10,70	3x8	33,5	1	Tenedor · Fourchette · Fork
H	62811	14,00	Ø7,5	-	6	Servidor espaguetis · Cuillière à spaguetis · Spaguetti server
I	62601	90,10	-	-	1	Juego 5 piezas · 5 utensiles de cuisine · 5 pds. kichen tools
	62630	23,90	40	-	1	Soporte juego · Soutien · Hangring rack

Cacillo (62603)  
Espumadera (62604)  
Tenedor (62605)  
Espátula (62606)  
Cuchara lisa (62607)

Inox  
Dishwasher

# MONOBLOCK

## Colección



	Ref	€	cm	L (cm)	U.Venta	
A	62503	8,20	Ø9	31,5	1	Cacillo · Louche · Ladle
B	62507	6,60	6,5x10	34,5	1	Cuchara · Cuillière · Ladle
C	62504	8,30	Ø11,5	35,0	1	Espumadera · Ecumoire · Skimmer
D	62506	6,40	8x10	35,5	1	Espátula · Spatule · Spatula
E	62505	5,60	2,5x10	33,5	1	Tenedor · Fourchette · Fork

# DUE

## Colección

Inox 18/10 PA Nylon Si Silicone Colgador Hanger Dishwasher BPA free



ES

- Colección de utensilios de nylon, ofrece un diseño versátil y cómodo.
- Mangos fabricados en acero inoxidable 18/10 de gran calidad y resistencia.
- Utensilios antiadherentes y flexibles.
- Soporta fuertes cambios de temperatura.
- Libres de BPA.

FR

- Collection d'ustensiles en nylon, offrant un design polyvalent et confortable.
- Poignées en acier inoxydable 18/10 de haute qualité et résistant.
- Ustensiles antiadhésifs et flexibles.
- Résiste aux fortes variations de température.
- Sans BPA.

EN

- Nylon utensils collection, offering a versatile and comfortable versatile and comfortable design.
- Handles made of high quality and resistant 18/10 stainless steel.
- Non-stick and flexible utensils.
- Withstands strong temperature changes.
- BPA free.



	Ref	€	cm	L (cm)	U.Venta	
A	68270	8,40	7x10,5	36,5	6	Cuchara · Cuillière · Ladle
B	68271	8,60	10,5x9,5	33,5	6	Cacillo · Louche · Ladle
C	68272	8,40	10,5x10,5	36,5	6	Espumadera · Ecumoire · Skimmer
D	68274	8,60	8,5x10,5	37,5	6	Espátula · Spatule · Spatula
E	68275	8,50	8,5x10,5	37,5	6	Espátula perforada · Spatule perforee · Perforated spatula
F	68273	8,10	6,5x9,5	36,5	6	Servidor espaguetis · Cuillière à spaguetis · Spaguetti server
G	68276	8,60	8x14,5	36,5	6	Paleta de pescado · Pelle à poisson · Fish turner

# BLACK

## Colección



125 ml

# ECO

## Colección



110 ml

40 ml

	Ref	€	cm	L (cm)	U.Venta	
A	98803	5,10	Ø9,5	29,0	12	<b>Cacillo</b> · Louche · Ladle
B	98807	4,30	7,5x10	30,5	12	<b>Cuchara</b> · Cuillère · Ladle
C	98808	4,00	7,5x10	30,5	12	<b>Cuchara perforada</b> · Cuillère perforee · Perforated ladle
D	98804	4,80	Ø11	31,5	12	<b>Espumadera</b> · Ecumoire · Skimmer
E	98806	4,40	8x10	33,0	12	<b>Espátula perforada</b> · Spatule perforee · Perforated spatule
F	98810	3,80	8x6,5	27,0	12	<b>Cacillo salsa</b> · Louche sauce · Gravy ladle
G	98811	3,90	Ø7,5	29,0	12	<b>Servidor espaguetis</b> · Cuillère à spaguettis · Spaguetti server



30 ml

# GREY

## Colección



**Núcleo reforzado para una mayor resistencia sin perder flexibilidad en los bordes. Diseñados en una sola pieza, sin costuras ni grietas**  
Reinforced core improves strength without losing flexibility around the edges. Designed in a single piece without seams or cracks



110 ml

	Ref	€	cm	L (cm)	U.Venta	
A	98903	3,80	8x9,5	31,0	12	<b>Cacillo</b> · Louche · Ladle
B	98907	3,80	6,5x10	30,0	12	<b>Cuchara</b> · Cuillère · Ladle
C	98908	3,80	6,5x10	30,0	12	<b>Cuchara perforada</b> · Cuillère perforee · Perforated ladle
D	98905	3,80	7,5x9	25,0	12	<b>Cuchara salsa</b> · Cuillère sauce · Gravy spoon
E	98906	3,80	9x10	31,0	12	<b>Espátula perforada</b> · Spatule perforee · Perforated spatule
F	98912	3,80	8x12	28,0	12	<b>Espátula corta</b> · Spatule court · Short spatule
G	98913	3,80	4x7	31,0	12	<b>Espátula larga</b> · Spatule longue · Long spatule
H	98904	3,80	Ø11	33,0	12	<b>Espumadera</b> · Ecumoire · Skimmer
I	98910	3,80	6x6,5	27,0	12	<b>Cacillo salsa</b> · Louche sauce · Gravy ladle
J	98911	3,80	6x8	30,0	12	<b>Servidor espaguetis</b> · Cuillère à spaguettis · Spaguetti server
K	98909	3,80	8x16	32,0	12	<b>Paleta de pescado</b> · Pelle à poison · Fish turner
L	98914	3,80	7x7	30,0	12	<b>Batidor</b> · Fouet · Whisk

	Ref	€	cm	L (cm)	L (cm)	
A	64466	7,70	Ø9,5	29,0	1	<b>Cacillo</b> · Louche · Ladle
B	64469	6,80	5,6x9,5	29,0	1	<b>Cuchara</b> · Cuillère · Ladle
C	64467	7,70	Ø9	29,0	1	<b>Espumadera</b> · Ecumoire · Skimmer
D	64468	6,80	7,5x9,5	29,0	1	<b>Espátula perforada</b> · Spatule perforee · Perforated spatule
E	64470	7,50	5,5x9,5	27,0	1	<b>Servidor espaguetis</b> · Cuillère à spaguettis · Spaguetti server
F	64471	6,80	4x12,5	27,0	1	<b>Espátula estrecha</b> · Spatule étroite · Narrow spatule
G	64462	7,70	-	29,0	1	<b>Pinza larga</b> · Pince longue · Long tong
H	64463	5,50	-	27,5	1	<b>Cuchara</b> · Cuillère · Ladle
I	64464	5,50	5,5x8	27,5	1	<b>Espátula</b> · Spatule · Spatula
J	64465	5,60	-	27,5	1	<b>Pincel</b> · Pinceau · Brush



# BRUN Colección



Fabricadas en madera de haya natural de alta calidad, acabadas con aceites naturales  
Made from natural beech wood of high quality and finished with natural oils



	Ref	€	cm	L (cm)	U.Venta	
A	68175	6,00	6x10	30,0	6	<b>Cuchara</b> · Cuillère · Ladle
B	68176	6,30	7x10	30,0	6	<b>Cuchara perforada</b> · Cuillère perforee · Perforated ladle
C	68177	6,00	6,5x10	30,0	6	<b>Espátula</b> · Spatule · Spatula
D	68178	6,20	7,5x12	30,0	6	<b>Espátula perforada</b> · Spatule perforee · Perforated spatula
E	68179	6,50	6,5x10	30,0	6	<b>Cuchara especial</b> · Cuillère spécial · Special spoon
F	68173	7,00	8x7	30,0	6	<b>Cuchara ensalada</b> · Cuillère à salade · Salad spoon
G	68174	7,00	8x7	30,0	6	<b>Tebnedor ensalada</b> · CFourchette à salade · Salad fork

# NORDIC Colección



Cabezal fabricado en nylon, resistente y duradero, libre de BPA. Mango ergonómico de madera de haya 100% natural  
Head made of nylon. Strong and long lasting. BPA free. Ergonomic natural beech wood handle.



	Ref	€	cm	L (cm)	U.Venta	
A	68280	4,80	Ø9	32,0	1	<b>Cacillo</b> · Louche · Ladle
B	68281	4,80	6,2	34,0	1	<b>Cuchara</b> · Cuillère · Ladle
C	68282	4,80	8,5	35,3	1	<b>Espátula perforada</b> · Spatule perforee · Perforated spatula
D	68283	4,80	11,2	34,3	1	<b>Espumadera</b> · Ecumoire · Skimmer
E	68284	4,80	6,5	34,0	1	<b>Servidor espaguetis</b> · Cuillère à spaguetis · Spaguetti server

# UNITE Colección



ES

- **Cabezal fabricado en silicona de grado alimentario de máxima calidad (libre de BPA).**
- **Mango ergonómico y antideslizante fabricado en madera de haya natural.**
- **PELADOR: Cabezal fabricado en polipropileno (libre de BPA) y fibra de vidrio; material ultrarresistente y duradero. Cuchilla de acero inoxidable de máxima calidad.**
- **BATIDOR: 2 en 1: bate y recoge. Varillas en acero inoxidable. Espátula de silicona inyectada en una de las varillas (certificado LFGB y libre de BPA).**

FR

- Tête fabriquée en silicone alimentaire de la plus grande qualité (sans BPA).
- Manche ergonomique et antidérapant fabriqué en hêtre naturel.
- ÉPLUCHEUSE : tête fabriquée en polypropylène (sans BPA) et fibre de verre ; matériau ultrarésistant et durable. Lame en acier inoxydable de la plus grande qualité.
- FOUET : 2 en 1 : fouetter et ramasser. Lames en acier inoxydable. Spatule en silicone injectée dans l'une des lames (certifiée LFGB et sans BPA).

EN

- Head made of top quality food grade silicone (BPA free).
- Ergonomic non-slip handle made of natural beech wood.
- PEELER: head made of polypropylene (BPA free) and fibreglass, which is ultra-durable and long lasting. Top quality stainless steel knife.
- WHISK: 2 in 1: Beat and scrape. Blades made of stainless steel. Silicone spatula injected into one of the blades (LFGB certified and BPAfree).



	Ref	€	cm	L (cm)	U.Venta	
A	68187	6,70	Ø8	31,5	1	<b>Cacillo</b> · Louche · Ladle
B	68185	5,80	6,7x10,5	32,0	1	<b>Cuchara</b> · Cuillère · Ladle
C	68195	4,30	5,6x8,5	26,5	1	<b>Espátula</b> · Spatule · Spatula
D	68186	5,90	7,5x10,5	33,5	1	<b>Espátula perforada</b> · Spatule perforee · Perforated spatula
E	68188	6,80	Ø11,5	33,5	1	<b>Espumadera</b> · Ecumoire · Skimmer
F	68189	5,90	5,5x9,5	32,5	1	<b>Servidor espaguetis</b> · Cuillère à spaguetis · Spaguetti server
G	68196	4,10	5,5x0,5	24,0	1	<b>Pincel</b> · Pinceau · Brush
H	68197	4,20	-	14,5	1	<b>Pelador liso</b> · Éplucheuse plate · Peeler plain blade
I	68198	4,20	-	14,5	1	<b>Pelador dentado</b> · Éplucheuse dentelé · Serrated peeler
J	68199	5,90	-	27,0	1	<b>Batidor</b> · Fouet · Whisk

# NATURAL & BLACK

## Colección



ES

- Fabricadas en fibra de madera, máxima calidad. Natural y ecofriendly.
- Robustas, resistentes y antibacterianas.
- Orificio para colgar.
- Fáciles de limpiar y aptas para el lavavajillas.

FR

- Fabriqués en fibres de bois de la plus haute qualité. Naturel et ecofriendly.
- Robusts, résistants et antibactériens.
- Orifice pour suspendre.
- Facile à nettoyer et apte pour le lave-vaisselle.

EN

- Made from wood fibre of the highest quality. Natural and ecofriendly.
- Robust, resistant and anti-bacterial.
- Hole for hanging.
- Easy to clean and dishwasher safe.



Natural

Black

	Ref	€	L (cm)	U.Venta
A	68165	7,20	29,5	1
B	68166	6,70	29,5	1
C	68167	7,40	29,5	1
D	68168	6,90	29,5	1
E	68169	7,00	29,5	1

	Ref	€	L (cm)	U.Venta	
	68265	7,60	29,5	1	Cuchara · Cuillère · Ladle
	68266	7,00	29,5	1	Espátula · Spatule · Spatula
	68267	7,70	29,5	1	Cuchara perforada · Cuillère perforee · Perforated ladle
	68268	7,20	29,5	1	Espátula perforada · Spatule perforee · Perforated spatule
	68269	7,30	29,5	1	Tenedor · Fourchette · Fork

# VARIOS

## Utensilios

Inox 18/10 Dishwasher

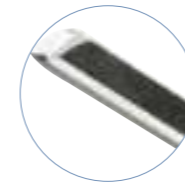

Sección cuadrada (2,5x2,5 mm) Square section



### Pincho moruno (6) Inox

Brochette carre en inox. (6) · Fleischspiesse (6), Rostfrei St. steel skewersquare wire (6) · Espeto moruno Inóx (6)

Ref	€	L (cm)	U.Venta
* 62446	4,90	20,0	12
62435	5,60	30,5	12
62445	6,60	40,5	12

\* Aptas para las freidoras de aire (ref: 69508-69511-69513-69515) Suitable for air fryers (ref: 69508-69511-69513-69515)



### Cuchara apoya utensilios

Cuillère ramasse ustensiles · Vorlegelöffel Spoon holder utensils · Colher recolhe utensilios

Ref	€	cm	L (cm)	U.Venta
62972	11,50	25x12	25	1

AL Aluminium



### Barra sujeción notas

Barre à notes · Zettelhalter Order rall · Barra fixação notas

Ref	€	L (cm)	U.Venta
60731	11,70	30,50	1
60746	15,20	46,00	1
60761	18,20	61,00	1
60776	21,00	76,00	1
60791	26,10	91,50	1

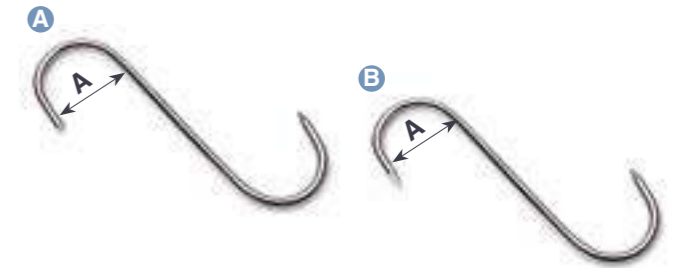

### 6 ganchos carnicero

6 crochets de boucher · 6-Tig Metzgerhaken 6 butchers hook · 6 ganchos de carnicero

	Ref	€	Puntas	Ø (mm)	L (cm)	A (cm)	U.Venta
A	39043	11,70	1	5	12,5	3,7	4
	39044	18,10	1	5	18,5	4,5	1
B	39047	11,80	2	5	12,5	3,7	4
	39048	18,30	2	5	18,5	4,5	1

Inox



### Contenedor cubiertos

Panier à couverts · Besteckköcher Cutlery holder · Copos para talheres

	Ref	€	Ø (cm)	h (cm)	L	U.Venta
	62962	21,00	12	13,6	1,40	1
	62963	24,40	12	18,7	2,00	1



### Colgador de barra

Penderie murale · Hängeleiste Wall hanger · Suporte de barra

	Ref	€	Unidades	L (cm)	U.Venta
	60740	22,50	6	40	1
A	60760	31,00	8	60	1
	60710	42,90	12	100	1
B	60700	6,70	6	-	12

Juego 6 ganchos Ensemble 6 crochets 6 hook set

# INOX

## Espátulas

Inox  
Dishwasher



ES

- Espátulas de gran flexibilidad
- Ideal para voltear los alimentos como pescados sin romperlos.
- Su borde biselado ayuda a deslizarse debajo de los alimentos.
- El revestimiento de silicona protege las superficies antiadherentes (60726).
- Las ranuras de la espátula permiten que la grasa se escurra.
- Higiénica y fácil de utilizar y limpiar.
- Apta para el lavavajillas.

FR

- Spatules d'une grande flexibilité.
- Idéale pour retourner les aliments tels que les poissons sans les casser.
- Son bord biseauté aide à se glisser sous les aliments.
- Le revêtement en silicone protège les surfaces antiadhésives (60726).
- Les rainures de la spatule permettent à la graisse de s'écouler.
- Hygiénique et facile à utiliser et nettoyer.
- Apte pour le lave-vaisselle.

EN

- Highly flexible spatulas.
- Perfect for turning over food like fish without breaking it apart.
- Its bevelled edge helps it slide under food.
- The silicon coating protects non-stick surfaces (60726).
- The grooves on the spatula let fat flow away.
- Hygienic and easy to use and clean.
- Dishwasher safe.



2 in 1  
Cortar · Cut    Servir · Serve up



**Espátula flexible pescado**

Spatule flexible à poisson · Fisch Schaufel, flexible  
Flexible spatula to fish · Espátula flexível para peixe

Ref	€	L (cm)	U.Venta
60426	4,40	30	6



**Espátula de pescado PRO**

Spatule à poisson · Fischheber  
Fish spatula · Espátula de peixe

Ref	€	L total (cm)	Paleta (cm)	U.Venta
60726	13,60	30	18x8	1



**Espátula serrada**

Spatule à gâteau · Backschaufel  
Serrated spatula · Espátula com serrilha

Ref	€	cm	U.Venta
62677	8,80	30x5,5	6

Preparación  
Food processing



### Espátula grill acodada

Spatule coudée our grill - Winkelpalette  
Bent grillspatula - Espátula comprida grelha

Ref	€	cm	U.Venta
60434	5,90	12x27	6



### Paleta triangular mango sólido

Grattoir manche noir m/solide - Bratenspachtel, Stiel  
Straight Scraper/turner - Espátula triangular cabo sólido

Ref	€	cm	U.Venta
60430	6,80	10x11,5	12



### Espátula lisa mango sólido

Spatule lisse m/solide - Backschaufel, f. Festsoffe  
Straight spatula - Espátula lisa cabo sólido

Ref	€	cm	U.Venta
60425	4,80	7x13,5	12



### Espátula larga acodada mango sólido

Spatule longue coudée m/solide - Winkelpalette, lang  
Long bent spatula - Espátula comprida c/cabo sólido

Ref	€	L (cm)	U.Venta
60467	3,90	20	12
60468	4,00	25	12
60469	4,10	30	12



### Espátula larga recta mango sólido

Spatule longue droite m/solide - Palette, lang, gerade  
Long straight spatula - Espátula comprida c/cabo sólido

Ref	€	L (cm)	U.Venta
60461	3,70	15	12
60462	3,80	20	12
60463	3,90	25	12
60464	4,00	30	12
60465	4,10	35	12



### Espátula repostería

Pâtisserie spatule - Gebackpalette  
Pastry spatula - Espátula pastelería

Ref	€	cm	U.Venta
60443	4,00	6,5x14,5	12



### Espátula mini acodada

Mini spatule coudée - Winkelpalette Mini  
Mini bent spatula - Espátula mini comprida

Ref	€	cm	U.Venta
60442	3,70	2x9	12

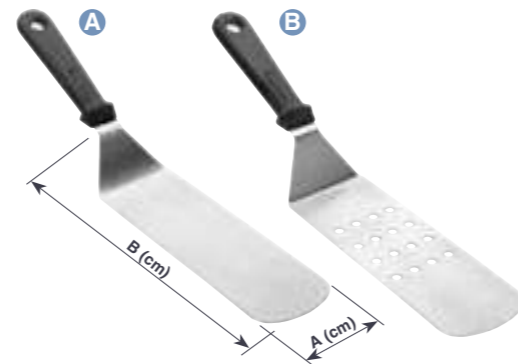

### Espátula lisa mango sólido

Spatule lisse m/solide - Spachtel, mit solidem Stiel  
Straight spatula - Espátula lisa cabo sólido

Ref	€	AxB (cm)	U.Venta
A 60420	5,30	7,5x21,5	12
B 60421	5,20	7,5x21,5	12



### Espátula gigante inox

Spatule geante en Inox - Rührspatel, Edelstahl  
St steel long handle Turner - Espátula gigante Inox

Ref.	€	L (cm)	U.Venta
61481	66,60	80	1
61421	72,80	120	1



### Pala profesional polietileno

Pelle professionnelle polyéthylène - Professionnelle Ruhrspatel, Polyethylene  
Polyethylene professional shovel - Pá profesional polietileno

Ref.	€	L (cm)	U.Venta
60404	77,20	81,5	1

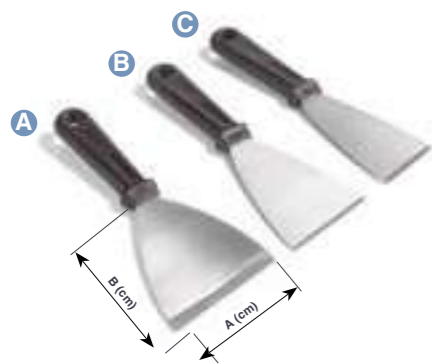

### Espátula plancha mango sólido

Spatule m/solide - Grillspachtel, mit solidem Stiel  
Straight spatula - Espátula grelha cabo sólido

Ref	€	A (cm)	B (cm)	U.Venta
A 60422	4,60	10	11,5	12
B 60445	3,90	8	11,5	12
C 60446	3,80	6	11,5	12



### Espátula mango negro

Spatule manche noir - Schaufel mit schwarzem Stiel  
Solid turner w/black H. - Espátula cabo negro

Ref	€	AxB (cm)	L (cm)	U.Venta
A 60435	7,60	7,5x17	35	6
B 60438	7,70	7,5x17	35	6

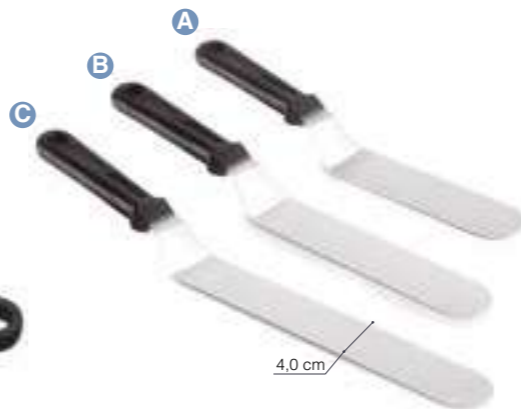

### Espátula acodada

Spatule coudée - Winkelpalette  
Bent spatula - Espátula comprida

Ref	€	L (cm)	U.Venta
A 60482	3,90	15	12
B 60483	4,20	19	12
C 60484	4,50	24	12



### Pala para patatas

Pelle à pommes de terre - Kartoffelschaufel  
Potato shovel - Pá de batatas

Ref	€	cm	e (mm)	NºAsas	U.Venta
A 62678	12,60	20x22	0,7	1	1
B 62679	14,80	20x22	0,7	2	1

- Palas profesionales fabricadas en acero inoxidable de gran calidad.
- Diseño trapezoidal para recoger y embolsar patatas fritas en fracciones individuales de forma rápida.
- Multifuncional: también se puede usar para servir palomitas de maíz, nueces, hielo o dulces.
- 1 o 2 mangos ergonómicos y antideslizantes ambidiestros.
- Fácil de limpiar. Aptas para el lavavajillas.

- Pelle professionnelle fabriquée en acier inoxydable de grande qualité.
- Forme trapézoïdale pour attraper et mettre rapidement en cornet des frites en portions individuelles.
- Multifonctions : peut également être utilisée pour servir du pop-corn, des noix, des glaçons ou des bonbons.
- 1 ou 2 manches ergonomiques et antidérapants pour des utilisateurs aussi bien gauchers que droitiers.
- Facile à nettoyer. Compatible avec le lave-vaisselle.

- These professional French fry scoops are made of high quality stainless steel.
- They have a trapezoidal design for scooping and bagging individual portions of French fries quickly.
- Multi-function: they can also be used to serve popcorn, nuts, ices or sweets.
- They have one or two ergonomic non-slip handles for right and left-handed users.
- Easy to clean and dishwasher safe.

# PIZZA

## Colección

Inox



- Caciillo para salsas fabricado en acero inoxidable de máxima calidad.
- Fondo plano para extender fácilmente y de manera uniforme las salsas sobre la base de la pizza.
- Ideal para salsa de tomate.
- 80 g de capacidad, ofrece la porción ideal para pizzas estándar de 30 cm.

- Louche à fond plat pour sauces fabriquée en acier inoxydable de la plus grande qualité.
- Fond plat pour étaler facilement et uniformément les sauces sur la base de la pizza.
- Idéale pour la sauce tomate.
- D'une capacité de 80 g, elle offre la dose idéale pour des pizzas standards de 30 cm.

- This sauce ladle is made of top quality stainless steel.
- It has a flat bottom to make it easy to spread sauce on a pizza base evenly.
- It's perfect for tomato sauce.
- The 80 g capacity is the perfect portion for standard 30 cm pizzas.



### Caciillo salsa

Louche sauce · Saucengliesslöffel  
Gravy ladle · Concha para molho

Ref	€	Ø(cm)	L (cm)	g	U.Venta
60562	5,60	7	27,0	80	1



- Dispone de 4 bandejas fabricadas en acero al carbono con revestimiento antiadherente, libres de PFOA, y soporte plegable de varillas de acero cromadas.
- Diámetro superior de la bandeja 29,5 cm / Diámetro interior 27cm.
- Resiste a altas temperaturas.
- Excelente conducción del calor para una cocción homogénea.
- Diseñado para cualquier horno de tamaño convencional.
- Multifuncional: las bandejas son aptas para hornear galletas, tartas, etc.

- It has four trays made of carbon steel with PFOA free non-stick coating and a collapsible support of chromed steel rods.
- Upper tray diameter 29.5 cm | Inside diameter 27 cm.
- Can withstand high temperatures, excellent heat conduction for even cooking.
- Designed for any conventionally sized oven.
- Multi-purpose: The trays can also be used to bake biscuits or cakes, etc.

## New



### Soporte para hornear pizzas

Support avec plaques à pizzas · Pizza Backblech  
Pizza baking rack · Suporte para cozer pizzas no forno

Ref	€	Bandejas	Ø (cm)	h (cm)	U.Venta
61462	24,20	4	29,5	21	1

## New



### Pala pizza WOOD

Pelle pizza · Pizaofen-Schaufel  
Pizza oven scoop · Pá de pizza

Ref	€	cm	L (cm)	U.Venta
61463	22,60	30,5x35,5	88	1

- Fabricada en aluminio de alta calidad con un mango de madera de caucho de 43 cm de largo.
- Ideal para pizzas, hogazas, barras de pan, pasteles, etc.
- Permite manipular los alimentos en el horno garantizando una máxima seguridad.
- Ahorra espacio en la cocina: el mango es desmontable e incluye una cuerda para colgar.

- Fabriquée en aluminium de grande qualité avec un manche en bois d'hévéa de 43 cm de longueur.
- Idéale pour les pizzas, les fougasses, les pains, les gâteaux, etc.
- Permet de manipuler les aliments dans le four en garantissant une sécurité maximale.
- Gain d'espace dans la cuisine : le manche est démontable et inclut une corde pour la suspension.

- This pizza peel is made of high quality aluminium and has a 43 cm long rubberwood handle.
- It's perfect for pizzas, loaves of bread or cakes, etc.
- You can use it to handle food in the oven with maximum safety.
- It saves space in the kitchen. The handle is removable and it has a rope to hang it with.

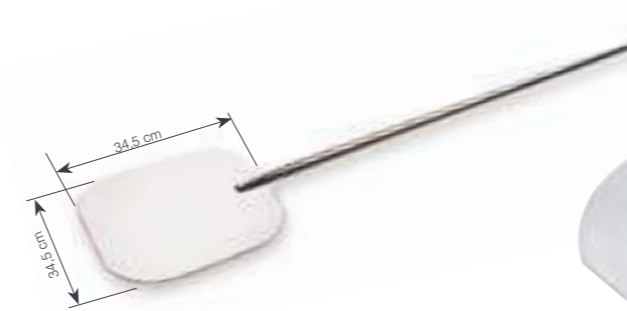

### Pala pizza LUNGO

Pelle pizza · Pizaofen-Schaufel  
Pizza oven scoop · Pá de pizza

Ref.	€	L (cm)	U.Venta
61460	102,90	160	1



### Espátula pizza

Spatule pizza · Pizzaspatel  
Pizza spatula · Espátula pizza

Ref	€	cm	U.Venta
60424	13,80	16,5x17,5x5	12



### Pala pizza

Pelle pizza · Pizzaschaukel, flach  
Pizza flat scoop · Espátula pizza

Ref	€	cm	U.Venta
61461	14,00	25x36	1

## New



### Cortapizza PRO

Roulette pizza · Pizzaschneider  
Pizza cutter · Corta-Pizza

Ref.	€	L (cm)	U.Venta
61465	7,50	35	1

- Hoja fabricada en acero inoxidable extremadamente afilada de gran calidad.
- Permite realizar cortes firmes y rectos con un solo movimiento gracias a su borde curvo afilado.
- Mango ergonómico y 100% seguro.
- Multifuncional; corta pizzas, tartas, quesos, pan, etc. y pica alimentos y hierbas.
- Perfecto para uso profesional o doméstico.
- Incluye protector de hoja de polipropileno para evitar cortes y un almacenamiento seguro.

- Blade made of extremely sharp, high quality stainless steel.
- Its sharp, curved edge makes firm, straight cuts in just a single movement.
- Ergonomic handle and 100% safe.
- Multifunctional: slices pizzas, pies, cheese, bread, etc. and minces food and herbs. 35 cm cutting length.
- Perfect for professional or home use.
- Includes polypropylene blade guard to prevent cuts and for safe storage.

### Cortapizza

Roulette pizza · Pizzaschneider  
Pizza cutter · Corta-Pizza

Ref	€	Ø (cm)	U.Venta
A 60429	5,00	10	12
B 67004	17,50	10	1
C 67028	12,10	10	1
D 67027	5,80	8	6

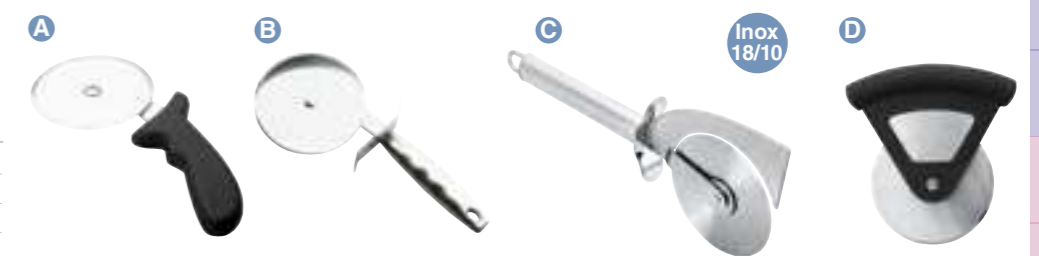

# RASQUETAS

## Colección



Diseño apilable  
Stackable design

### Rasqueta

Coupe pate · Schaber  
Scraper · Raspador

Ref	€	cm	U.Venta
67041	25,10	13,8x13	1

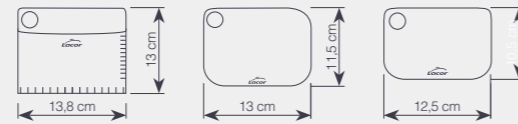

- El cortador de masa está fabricado en acero inoxidable de máxima calidad con escalas de medición tanto en cm como en in. Además, dispone de un mango antideslizante y ergonómico. Está diseñado para cortar, dividir y formar masas, así como recoger harinas, etc.
- Espátula de silicona exible de gran calidad y grado alimenticio. Ideal para el empleo en superficies poco uniformes, como boles esféricos.
- El raspador está fabricado en Polipropileno + Fibra de vidrio de grado alimenticio y diseñado principalmente para decorar tartas y pasteles de forma práctica y sencilla.

- Dough cutter made of top quality stainless steel with measurements marked in cm and inches. It has a non-slip ergonomic handle. It's designed to cut, divide and shape dough or pick up flour, etc.
- High quality flexible food safe silicone spatula, perfect for using on uneven surfaces like spherical bowls.
- Scraper made of food grade Polypropylene + Glass fiber mainly designed for decorating cakes and pies in a simple and easy way.



### Rasqueta INOX

Coupe pate · Schaber  
Scraper · Raspador

Ref	€	cm	U.Venta
67005	12,80	15x9	6
67006	12,40	15x9	6



Escala de medición  
Measurement scale

### Rasqueta INOX BLAK

Coupe pate · Schaber  
Scraper · Raspador

Ref	€	cm	U.Venta
67029	9,40	16,5x10,5	6



### Rasqueta FLEX

Coupe pate · Schaber  
Scraper · Raspador

Ref	€	cm	U.Venta
67414	8,90	9x15	1

# PINCELES

## Colección



### ES

- Para cocina o repostería.
- Prácticas espátulas o lenguas de gato para rebañar boles, cazuelas, fuentes, etc.
- Pinceles ideales para pincelar con aceites o salsas, marinar carnes o pescados, engrasar moldes, untar con aceite, huevo batido, almíbar, etc.
- No absorben olores ni sabores.

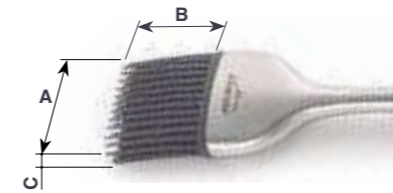

Mango de polipropileno  
Polypropylene handle

### Pincel VIROLA

Pinceau · Silikonpinsel  
Brush · Pincel

Ref	€	A (cm)	B (cm)	C (cm)	L (cm)	U.Venta
64430	4,30	2,8	5,0	5,0	23,0	1
64435	5,00	3,2	5,5	7,0	24,0	1
64440	5,20	3,8	5,5	7,0	24,5	1
65044	6,40	4,2	6,5	8,0	25,0	1
65050	7,70	4,7	6,5	8,0	26,0	1

Dimensiones reales · Real dimensions

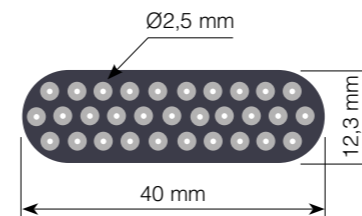

### Pincel de silicona MIX

Pinceau de cuisine en silicone · Silikonpinsel  
Silicone brush · Pincel de silicone

Ref	€	A (cm)	B (cm)	C (cm)	L (cm)	U.Venta
64431	7,20	3,8	4,0	1,0	24	12

### EN

- For cooking or baking.
- Practical spatulas for scraping bowls, pots, dishes, etc.
- Brushes ideal for brushing oils or sauces, marinating meat or fish, greasing baking tins, and basting with oil, egg, syrup, etc.
- Doesn't absorb smells or tastes.

Inox  
18/10



### Pincel de silicona PRO

Pinceau en silicone · Silikonpinsel  
Silicon brush · Pincel silicone

Ref	€	A (cm)	B (cm)	C (cm)	L (cm)	U.Venta
64418	10,80	4,0	4,0	1,4	22	1
64422	12,10	4,0	4,0	1,4	23	1



### Pincel de silicona

Pinceau en silicone · Silikonpinsel  
Silicon brush · Pincel de silicone

Ref	€	A (cm)	B (cm)	C (cm)	L (cm)	U.Venta
64441	6,70	5,8	3,4	1,7	23	1

Mango de Haya natural  
Natural beech handle



### Pincel UNITE

Pinceau · Silikonpinsel  
Brush · Pincel

Ref	€	A (cm)	B (cm)	C (cm)	L (cm)	U.Venta
68196	4,10	5,5	3,1	1,1	24,5	1

# ESPÁTULAS SILICONA

## Colección



ES

- Fabricados en silicona de alta calidad libre de BPA.
- Núcleo reforzado para una mayor resistencia sin perder flexibilidad en los bordes. Diseñados en una sola pieza.
- Resistentes a altas temperaturas.
- Mango ergonómico suave al tacto y antideslizante.
- No rayan ni dañan artículos de cocina con antiadherente.
- Fáciles de limpiar. Aptas para el lavavajillas.

FR

- Fabriqué en silicone de haute qualité sans BPA.
- Noyau renforcé pour une résistance accrue sans perte de flexibilité des bords. Conception monobloc, sans coutures ni fissures.
- Résistant aux hautes températures.
- Poignée ergonomique, douce au toucher et antidérapante.
- Ne raye pas et n'endommage pas les ustensiles de cuisine antiadhésifs.
- Facile à nettoyer. Lavable au lave-vaisselle.

EN

- Made of high quality BPA free silicone.
- Reinforced core improves strength without losing flexibility around the edges. Designed in a single piece without seams or cracks.
- Can withstand high temperatures.
- Soft and non-slip ergonomic handle.
- Does not scratch cooking utensils with non-stick coating.
- Easy to clean. Dishwasher safe.



### Utensilios GREY

Ustensiles en silicone · Silikonutensilien  
Silicone utensils · Utensilios de silicone

	Ref	€	L (cm)	U.Venta
	64459	15,60	27,5	1
A	64463	5,50	27,5	1
B	64464	5,50	27,5	1
C	64465	5,60	27,5	1

### Utensilios OCEAN

Ustensiles en silicone · Silikonutensilien  
Silicone utensils · Utensilios de silicone

	Ref	€	L (cm)	U.Venta
	64452	16,70	27,5	1
	64453	5,80	27,5	1
	64454	5,80	27,5	1
	64455	5,80	27,5	1

Set 3 utensilios · Set 3 utensils  
Cuchara · Spoon  
Espátula · Spatula  
Pincel · Brush

Fe  
Iron



### Espátula silicona

Spatule en silicone · Teigschaber  
Silicone spatula · Espátula de silicone

	Ref	€	L (cm)	U.Venta
A	64444	5,90	28	1
B	64445	6,60	30	1
C	64446	6,70	31	1



Mango de polipropileno  
Polypropylene handle

### Espátula silicona

Spatule en silicone · Teigschaber  
Silicone spatula · Espátula de silicone

	Ref	€	L (cm)	U.Venta
	67421	4,60	20	1
A	67427	6,80	26	1
	67433	14,90	32	1
B	67434	4,70	30	12
	67435	5,40	29	12

### Espátula UNITE

Spatule · Backschauffel  
Spatule · Espátula

	Ref	€	cm	L (cm)	U.Venta
	68195	4,30	5,6x8,5	26,5	1

### Espátula silicona

Spatule en silicone · Teigschaber  
Silicone spatula · Espátula de silicone

	Ref	€	L (cm)	U.Venta
	64450	5,60	25	6
A	64451	8,90	35	6
	64460	5,80	25	6
B	64461	9,70	35	6

New

### Espátula para tarros

Spatule pour pots · Spatel für Einmachgläser  
Jar spatula · Espátula para frascos

	Ref.	€	cm	L (cm)	U.Venta
A	64490	2,40	3,8x8,4	25	1
B	64491	4,00	4,8x10,8	35	1



- Fabricada en silicona y ABS de alta calidad, libre de BPA.
- Resistente a altas temperaturas.
- Cabezal flexible y maleable. No raya ni daña artículos de cocina con antiadherente.
- Diseñada especialmente para rebañar tarros a la perfección, aprovechando hasta lo último de mermeladas, mayonesas, salsas, etc.
- Higiénica. Fácil de limpiar. Apta para el lavavajillas.

- Fabriqué en silicone et ABS de haute qualité sans BPA.
- Résistant aux températures extrêmes.
- Tête flexibilité et malléabilité. Ne raye pas et n'endommage pas les ustensiles de cuisine antiadhésifs.
- Spécialement conçue pour racler les pots à la perfection, récupérant ainsi les dernières gouttes de confiture, mayonnaise, sauce, etc.
- Hygiénique. Faciles à nettoyer. Lavable au lave-vaisselle

- Made of high quality BPA free silicone and ABS.
- Resistant to extreme temperatures.
- Flexible and malleable head. Does not scratch cooking utensils with non-stick coating.
- It's specially designed for scraping all kinds of jars to perfection, so you can enjoy every last bit of your marmalade, mayonnaise or sauce, etc.
- Hygienic. Easy to clean. Dishwasher safe.

### Set repostería (20 pcs.)

Exposant pâtisserie · Aufsteller Pastry  
Pastry display · Expositor pasteleria

	Ref	€	L (cm)	Pieza	U.Venta
A	64424	78,30	-	Caja (20 pcs.) / Set (20 pcs.)	1
B	64426	4,00	23,0	Pincel / Brush	12
C	64427	4,00	23,0	Espátula / Spatula	12
D	64428	4,00	23,0	Lengua gato / Spatula	12
E	64429	4,00	23,0	Batidor / Whisk	12



New

### Espátula profesional EXTRAplana

Spatula professionnelle · Profi-Spachtel  
Professional spatula · Espátula profesional

	Ref	€	L (cm)	U.Venta
A	61373	5,50	30	1
B	61375	6,00	35	1
C	61374	7,30	40	1



- Espátula extraplana fabricada en nylon y fibra de vidrio especialmente diseñada para uso profesional.
- Sólida e indeformable. Resistente a altas temperaturas.
- No absorbe olores ni sabores.
- Apta para el lavavajillas.

- Spatule extra plate fabriquée en nylon et fibre de verre spécialement conçue pour un usage professionnel.
- Résistante aux hautes températures.
- Solide et indéformable. N'absorbe ni les odeurs ni les goûts.
- Apte pour le lave-vaisselle.

- Super thin, glass fibre nylon spatula, specially designed for professional use.
- High temperature resistant.
- Robust and non-deformable.
- Does not absorb smells or flavours.
- Dishwasher safe.

# BATIDORES

## Colección

Inox  
18/10  
Dishwasher



A

Mango de Haya natural  
Natural beech handle



B



### Batidor varilla con espátula

Fouet avec grattoir · Schneebesen mit Schaber  
Whisk with spatula · Batedeira de varas com espátula

	Ref	€	L (cm)	U.Venta
A	68199	5,90	27,0	1
B	61627	6,20	32,0	12

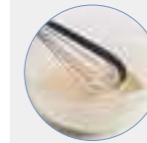

Batidor · Whisk

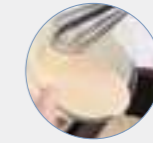

Espátula · Spatula

- Batidor de varilla con práctico raspador de silicona incorporado.
- 2 en 1: bate y recoge toda la mezcla del bol de forma fácil y rápida.
- Varillas fabricadas en acero inoxidable.
- Espátula de silicona inyectada en una de las varillas (certificado LFGB y libre de BPA).

- Mixeur en bâton avec raclette en silicone intégrée très pratique.
- 2 en 1 : fouette et recueille tous les mélanges dans le bol rapidement et facilement.
- Lames en acier inoxydable.
- Spatule en silicone injectée dans l'une des lames (certifiée LFGB et sans BPA).

- Blade mixer with practical built-in silicone scraper.
- 2 in 1: Beat and scrape out the entire mixture from the bowl quickly and easily.
- Blades made of stainless steel.
- Silicone spatula injected into one of the blades (LFGB certified and BPA free).

- Indeformable. Varillas de acero inoxidable 18/10. Mango de fibra de vidrio resistente.
- Ideal para batir crema de leche, huevos, claras a puntode nieve, masas ligeras, cremas, etc.

- Indéformable. Tiges en acier inoxydable 18/10. Manche en fibre de verre durable.
- Idéal pour fouetter la crème, les œufs, les blancs d'œufs, les pâtes légères, les crèmes, etc.

- Non-deformable. 18/10 stainless steel rods. Durable fibreglass handle.
- Ideal for whipping cream, eggs, egg whites, egg whites, light doughs, creams, etc.



### Batidor FIBREGLASS

Fouet · Schneebesen  
Whisk · Batedores

Ref	€	L (cm)	U.Venta
61624	11,80	25	6
61629	13,60	30	6
61634	15,40	35	6
61639	17,00	40	6
61644	20,40	45	6
61649	21,40	50	6



### Batidor silicona FIBREGLASS

Fouet en silicone · Schneebesen, Silikon  
Silicone whisk · Batedores silicona

Ref	€	L (cm)	U.Venta
61524	10,80	25	6
61529	11,70	30	6
61534	13,60	35	6

## New



Mango ergonómico  
Ergonomic handle

### Batidor FIBREGLASS

Fouet · Schneebesen  
Whisk · Batedores

Ref	€	L (cm)	U.Venta
61590	10,80	25	6
61591	11,70	30	6
61592	13,60	35	6

Inox



### Batidor MINI

Mini fouet Inox · Mini-Schneebesen  
Mini whisk · Mini batedor Inóx

Ref	€	L (cm)	U.Venta
61615	5,40	15	12
61620	6,00	20	12



### Batidor EXTRA 8

Fouet inox extra 8 · Schneebesen, Extra 8  
Extra 8 whisk · Batedor Extra 8

Ref	€	L (cm)	U.Venta
61625	8,50	25	6
61630	8,70	30	6
61635	9,10	35	6
61640	10,00	40	6
61645	10,80	45	6
61650	12,10	50	6
61655	12,80	55	6
61660	13,80	60	6



### Batidor SUPER 12

Fouet inox super 12 · Schneebesen, super 12  
Super 12 whisk · Batedor Super 12

Ref	€	L (cm)	U.Venta
61626	7,80	25	6
61631	8,40	30	6
61636	9,10	35	6
61641	9,60	40	6
61646	9,90	45	6
61651	10,80	50	6

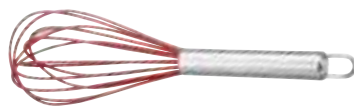

### Batidor varilla silicona

Fouet en silicone · Ruhrbesen auf Silikon  
Silicone wire whisk · Batedor vareta silicone

Ref	€	L (cm)	U.Venta
61621	8,00	20	12
61622	8,90	25	6
61623	9,90	30	12



### Batidor gigante

Fouet à purée · Kesselbesen  
Big whisk · Batedor gigante

Ref.	€	cm	Ø Varilla (mm)	U.Venta
60610	62,40	100	3	12
60612	80,00	129	3	12

Inox



### Batidor manivela

Batteur-mélangeur à manivelle · Schneequirl  
Egg beater · Batedor de manivela

Ref	€	U.Venta
62901	19,10	6



### Batidor capuccino

Batteur pour cappuccino · Capuccino-Mixer  
Capuccino mixer · Batedor capuccino

Ref	€	W	U.Venta
69041	26,70	2,7	1



# JARRAS MEDIDORAS

## Colección

Inox  
18/10  
Dishwasher



Marcajes de capacidad en el interior en onzas, ml, L y ccm (centímetro cúbico)  
Capacity markings inside in ounces, mL, L and ccm (cubic centimetres)

**Jarra medidora**  
Pot mesureur · Mass Behälter  
Measuring jug · Jarra de medidas

Ref	€	Ø (cm)	h (cm)	L	U.Venta
A 62745	14,40	9,0	10,5	0,5	1
B 62741	21,80	11,5	13,0	1,0	1
C 62742	25,80	15,0	17,0	2,0	1

**Jarra medidora INOX**  
Pot mesureur · Mass Behälter  
Measuring jug · Jarra de medidas

Ref.	€	Ø (cm)	L	U.Venta
62750	75,80	17x22,5	5,00	1

Vidrio  
Glass  
100% higiénica  
100% hygienic



Resistente a choques térmicos  
Highly resistant to thermal shock

**Jarra medidora CRISTAL**  
Pot mesureur · Mass Behälter  
Measuring jug · Jarra de medidas

Ref	€	L	U.Venta
67133	11,00	0,5	1

PMMA  
plastic  
BPA free



Sist. de lectura rápida en mililitros y cups  
Easily readable markings in millilitres and cups

**Jarra medidora SPIN**  
Pot mesureur · Mass Behälter  
Measuring jug · Jarra de medidas

Ref	€	L	U.Venta
67165	11,80	0,5	1

SAN  
plastic  
BPA free



Lectura rápida en litros, mililitros, onzas y cups  
Readable markings in liters, millilitres, ounces and cups

**Juego 3 jarras medidoras**  
Ensemble de 3 pot mesureur · 3-tlg. Satz Messbecher  
3 piece measuring jugs · Jogo 3 jarras de medidas

Ref	€	L	U.Venta
67131	15,20	0,25-0,5-1,0	1

PMMA  
plastic  
BPA free

Incluye borde para facilitar el vertido  
Includes rim for easy pouring



Marcajes de capacidad en ml, dl, onzas y cup  
Capacity markings in ml, dl, ounces and cups

**Vaso medidor BASIC**  
Verre doseur · Messbecher  
Measuring cup · Copo medidor

Ref	€	Ø (cm)	h (cm)	L	U.Venta
A 67075	7,40	8,5	16,0	0,5	1
B 67071	9,60	10,5	19,0	1,0	1

**New**



**Set 3 jarras medidoras**  
Setn 3 pichets doseurs · Messbecher, 3 Er-Setr  
Set of 3 measuring jugs · Conjunto 3 jarras medidas

Ref	€	Ø (cm)	h (cm)	L	U.Venta
67130	9,20	9,5	8,5	0,25	1
		11,0	10,0	0,50	
		13,0	11,5	1,00	

- Fabricadas en polipropileno de máxima calidad. 100% libres de BPA.
- Jarras graduadas en mililitros (ml), tazas (cup) y onzas (oz).
- Pico vertedor para facilitar el vertido y evitar derrames.
- Asa ergonómica con reposapulgares para facilitar el transporte, precisión y control en el vertido. Ambidiestro.
- Totalmente apilables, ocupando el mínimo espacio posible.

- Fabriqué en polypropylène de la plus grande qualité. 100% sans BPA.
- Pichets gradués en millilitres (ml), tasses (cup) et onces (oz).
- Bec verseur latéral pour mieux verser les liquides.
- Poignée ergonomique avec repose-pouces pour faciliter le transport et verser les liquides de façon plus précise et contrôlée. Ambidextre.
- Totalement empilables pour un gain de place maximum.

- Made of top quality polypropylene. 100% BPA free.
- Jugs graduated in millilitres (ml), cups (cup) and ounces (oz).
- Side spout for easy pouring.
- Ergonomic handle with thumb rest for easy carrying, precision and control when pouring. Ambidextrous.
- Fully stackable, taking up as little space as possible.

PP  
polypropylene  
BPA free

**Jarras medidoras**  
Pot mesureur · Mass Behälter  
Measuring jugs · Jarras de medidas

Ref	€	Ø (cm)	h (cm)	L	U.Venta
A 67210	3,50	9,0	13,8	0,5	1
B 67211	4,60	12,0	17,0	1,0	1
C 67212	7,90	15,0	20,8	2,0	1
D 67213	10,30	17,0	23,5	3,0	1
E 67214	16,00	20,0	27,5	5,0	1



Sistema de lectura rápida en ml, L y ccm (centímetro cúbico)  
Easily readable markings in ml, l and ccm (cubic centimeter)

PP  
polypropylene  
BPA free



Jarras apilables  
Stackable jugs

**Set 5 jarras medidoras**

Setn 5 pichets doseurs · Messbecher, 5 Er-Setr  
Set of 5 measuring jugs · Conjunto 5 jarras medidas

Ref	€	cm	h (cm)	L	U.Venta
67215	39,90	15x9	15,3	0,5	1
		18x11	18,8	1,0	
		22x15	23,0	2,0	
		24x17	26,0	3,0	
		27x20	30,2	5,0	

Sistema de lectura rápida en mililitros (ml), litros (L) y ccm (centímetro cúbico)  
Easily readable markings in millilitres (ml), Liters (l) and ccm (cubic centimeter)

# EXACT & PRACTIC

## Set de medición

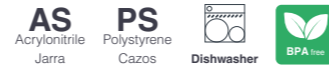

**ES** · Versátil. Ideal para ingredientes líquidos y secos.  
· Jarra con sistema de lectura rápida en litros y cups. Permite comprobar el nivel del líquido mientras se está vertiendo el contenido.  
· Cazos marcados en ml y bps para una rápida identificación.

**FR** · Polyvalent, idéal pour les ingrédients liquides et secs.  
· Pichet avec système de lecture rapide en Litres et Cups. Permet de vérifier le niveau du liquide tout en versant le contenu.  
· Cuillères marquées en ml et bps pour une identification rapide.

**EN** · Versatile: ideal for liquid and dry ingredients.  
· Jug with easy to see quantities marked in litres and cups and easy to check liquid level while pouring contents.  
· Ladles with ml and bps markings for easy reference.

Raspador · Scraper

6 cazos medidores

6 measuring cups  
(7,5 ml, 15 ml, 60 ml,  
85 ml, 125 ml, 250 ml)

Embudo · Funnel

Jarra medidora  
Measuring jug  
(1,0 L / 4 cups)

Compacto · Compact

### Set de medición EXACT

Set de mesure · Messbecher-Set  
Measuring set · Conjunto de medição

Ref	€	cm	h (cm)	L	U.Venta
62740	16,00	20x11	13,6	1,0	1

**ES** · Fabricadas en polipropileno de máxima calidad. 100% Libre de BPA.  
· Pequeño vertedor lateral para facilitar el vertido.  
· Asas ergonómicas para facilitar el transporte.  
· 100% estable gracias a los pies antideslizantes.

**FR** · Fabriqués en polypropylène de la plus grande qualité. 100% sans BPA.  
· Petit verseur latéral pour verser plus facilement.  
· Poignées ergonomiques pour faciliter le transport.  
· 100% stables grâce aux pieds antidérapants.

**EN** · Made of top quality polypropylene. 100% BPA free.  
· Small side spout for easy pouring.  
· Ergonomic handles for easy carrying.  
· 100% with non-slip feet.

PP  
polypropylene

Jarra medidora · Measuring jug (0,5 L)

Jarra medidora · Measuring jug (1,0 L)

Escurreidor · Colander (2,0 L)

Bol mezclador · Mixing bowl (3,5 L)

Apilables · Stackable

Graduadas (mililitros / cups)  
Graded ml and cup marking

### Set 4 boles PRACTIC

Ensemble de 4 récipients · Schüsseln, 4er-Set  
Set of 4 bowls · Conjunto de 4 tigelas

Ref	€	Ø (cm)	h (cm)	L	U.Venta
62633	35,10	11,5	9,3	0,5	1
		14,5	10,6	1,0	
		18,5	13,0	2,0	
		22,0	15,0	3,5	

# CALDEROS INOX

## Colección



**ES**

· Ideal para mezclar los alimentos.  
· Para uso profesional o doméstico.  
· Fabricados en acero inoxidable 18/10, material muy resistente a la corrosión y ácidos alimentarios.  
· Fácil limpieza: apto para el lavavajillas.

**FR**

· Idéal pour mélanger les aliments.  
· Pour un usage professionnel ou domestique.  
· Fabriqué en acier inoxydable 18/10, un matériau hautement résistant à la corrosion et aux acides.  
· Nettoyage facile : passe au lave-vaisselle.

**EN**

· Ideal for mixing food.  
· For professional or home use.  
· Made of 18/10 stainless steel, a material highly resistant to corrosion and food acids.  
· Easy cleaning: dishwasher safe.



### Caldero semiesférico sin asas

Bassine hemispherique s/anses · Schneeschlagkessel ohne Griffe  
Semi-spherical mixing bowl w/out/handles · Bacia semi-esférica sem asas

Ref.	€	Ø (cm)	h (cm)	L	U.Venta
50323S	36,50	22	11,0	2,70	1
50327S	42,60	26	13,0	4,00	1
50333S	57,20	32	17,0	9,50	1
50337S	64,90	36	18,0	12,00	1
50341S	108,90	40	21,0	14,50	1

A

Soporte  
Bowl stand



### Caldero semiesférico c/asas

Bassine hemispherique a/anses · Schneeschlagkessel mit Griffe  
Semi-spherical mixing bowl w/handles · Bacia semi-esférica com asas

Ref.	€	Ø (cm)	h (cm)	L	U.Venta
50323	48,10	22	11,0	2,70	1
50327	54,70	26	13,0	4,00	1
50333	70,30	32	17,0	9,50	1
50337	75,60	36	18,0	12,00	1
50341	108,10	40	21,0	14,50	1

A

Soporte  
Bowl stand



### Caldero cónico

Bassine conique · Wanne  
Mixing bowl · Bacia cónica

Ref	€	Ø (cm)	h (cm)	L	U.Venta
60013	12,40	13	6,1	0,55	1
60016	13,40	16	9,1	1,00	1
60020	18,40	20	11,7	2,12	1
60024	22,10	24	12,6	3,50	1
60028	27,60	28	13,4	5,25	1
60032	31,00	32	15,0	7,65	1
60036	42,90	36	16,0	11,00	1
60040	49,80	40	18,0	15,00	1



### Cazo servir 'POCHON'

Pochon · Suppenkelle "Pochon" (Für server)  
Pochon soup ladle for server · Caçarole servir "Pochon"

Ref	€	Ø (cm)	Mango (cm)	L (cm)	L	U.Venta
60520	59,70	20	22,50	42,5	2,00	1



### Caldero cónico con asas

Bassine conique à anses · Wanne mit Griffe  
Conical mixing bowl · Bacia cónica com asas

Ref.	€	Ø (cm)	h (cm)	L	U.Venta
50828	43,10	28	13,2	5,00	1
50832	47,80	32	14,5	7,00	1
50836	54,70	36	16,0	11,00	1
50840	60,80	40	18,0	15,00	1
50845	72,60	45	20,0	22,00	1
50850	87,10	50	21,0	30,00	1

garinox®



### Cubo

Seau · Eimer  
Pail · Balde

Ref	€	Ø (cm)	h (cm)	L	U.Venta
14114	9,30	16-12	15,5	1,40	1
14119	17,60	20-15	20,0	4,60	1
14124	21,90	24-17,2	20,5	5,60	1
14128	39,80	28-21	25,8	14,00	1

# BOLES INOX

## Colección



ES

- Set de 3 boles de acero inoxidable de máxima calidad.
- Acabado interior y exterior satinado.
- Versátiles: ideales para mezclar, batir, preparar masas y servir ensaladas o salsas.
- Perfectos para almacenar y conservar los alimentos.
- Compuesto por 3 boles perfectamente apilables entre sí.
- Base 100% antideslizante.
- Incluye 3 tapas herméticas fabricadas en polipropileno, libres de BPA.
- Marcaje de capacidad en el interior (L).
- Fácil limpieza. No aptos para el lavavajillas.

FR

- Ensemble de 3 bols en acier inoxydable de la plus grande qualité.
- Finition intérieure et extérieure satinée.
- Polyvalents : parfaits pour mélanger, battre, préparer des pâtes et servir des salades ou des sauces.
- Parfaits pour ranger et conserver les aliments.
- Composé de 3 bols parfaitement empilables entre eux.
- Fond 100% antidérapant.
- Inclut 3 couvercles hermétiques fabriqués en polypropylène, sans BPA.
- Marquage de capacité à l'intérieur (L).
- Nettoyage facile. Ne convient pas au lave-vaisselle.

EN

- Set of 3 top quality stainless steel bowls.
- Inner and outer satin finish.
- Versatile: ideal for mixing, whisking, making doughs and serving salads or sauces.
- Ideal for storing and preserving food.
- Comprises 3 perfectly stackable.
- 100% non-slip base.
- Includes 3 airtight lids made of BPA-free polypropylene.
- Capacity marks inside (L).
- Easy to clean. Not suitable for the dishwasher.



### Set 3 boles INOX

Ensemble de 3 récipients · Schüsseln, 3er-Set  
Set of 3 bowls · Conjunto de 3 tigelas

Ref	€	Ø (cm)	h (cm)	L	U.Venta
60050	39,20	16	10,0	1,5	1
		18	11,0	2,2	
		20	12,5	3,0	
60051	52,80	20	12,5	3,0	1
		22	13,5	3,8	
		24	14,0	4,0	

garinox®



### Bol cónico

Bol conique · Schüssel, konisch  
Conical mixing bowl · Bacia cónica

Ref	€	Ø (cm)	h (cm)	L	U.Venta
14016	3,80	16	6,5	0,90	12
14019	5,20	20	7,5	1,40	12
14025	9,40	24	9,0	2,50	1
14029	12,80	30	11,0	4,30	1
14033	17,80	34	13,5	7,50	1
14040	22,70	40	15,5	11,50	1
14046	32,20	45	17,5	17,40	1
14049	37,80	50	19,0	22,60	1

# BOLES PP

## Colección



ES

- Versátiles: ideales para mezclar, batir, preparar masas y servir ensaladas o salsas.
- Compuesto por 3 boles perfectamente apilables entre sí.
- Dispone de pico vertedor y pestaña de agarre antideslizante.
- Base 100% antideslizante.

FR

- Polyvalents : parfaits pour mélanger, battre, préparer des pâtes et servir des salades ou des sauces.
- Composé de 3 bols parfaitement empilables entre eux.
- Bec verseur et poignée antidérapante pour une meilleure prise en main.
- Fond 100% antidérapant.

EN

- Versatile: ideal for mixing, whisking, making doughs and serving salads or sauces.
- Comprises 3 perfectly stackable bowls.
- Featuring a pouring spout and non-slip grip. 100% non-slip base.



### Set 3 boles GREY

Ensemble de 3 récipients · Schüsseln, 3er-Set  
Set of 3 bowls · Conjunto de 3 tigelas

Ref	€	Ø (cm)	h (cm)	L	U.Venta
60054	41,80	21,0	12,5	1,4	1
		26,0	14,2	2,8	
		31,2	14,8	4,7	

ES

- Versátiles: ideales para mezclar, batir, preparar masas, servir ensaladas o salsas.
- Compuesto por 6 boles perfectamente apilables entre sí.
- Incluye 6 tapas fabricadas en polipropileno, libres de BPA.
- Perfectos para almacenar y conservar los alimentos.

FR

- Polyvalents : parfaits pour mélanger, battre, préparer des pâtes et servir des salades ou des sauces.
- Composé de 6 bols parfaitement empilables entre eux.
- Comprend 6 couvercles en polypropylène, sans BPA.
- Parfait pour stocker et conserver les aliments.

EN

- Versatile: ideal for mixing, whisking, making doughs, serving salads or sauces.
- Comprises 6 perfectly stackable bowls.
- Includes 6 lids made of polypropylene, BPA free.
- Perfect for storing and preserving food.



Cuerpos aptos para el lavavajillas  
Dishwasher safe bodies

### Set 6 boles MULTI

Ensemble de 6 récipients · Schüsseln, 6er-Set  
Set of 6 bowls · Conjunto de 6 tigelas

Ref	€	Ø (cm)	h (cm)	L	U.Venta
60055	20,00	10,0	5,0	0,25	1
		14,0	6,8	0,80	
		17,0	8,0	1,15	
		20,3	9,5	2,00	
		24,3	11,0	3,35	
		28,3	12,5	5,25	

# ETERN

## Colección



New



**Recipiente rectangular**  
Récipient rectangulaire · Rechteckbehälter  
Rectangular container · Recipiente retangular

Ref	€	ml	cm	h (cm)	U.Venta
64600	11,10	800	18x13,5	7	1
64601	12,70	1200	20,5x15,5	7,5	1
64602	15,70	1800	23x17,5	8	1



**Recipiente cuadrado**  
Récipient carré · Quadratischer Behälter  
Square container · Recipiente quadrado

Ref	€	ml	cm	h (cm)	U.Venta
64603	9,80	650	14x14	7	1
64604	13,80	1500	18,5x18,5	8	1



**Recipiente redondo**  
Récipient rond · Runder Behälter  
Round container · Recipiente redondo

Ref	€	ml	cm	h (cm)	U.Venta
64605	10,00	700	16x16	6,5	1
64606	14,30	1500	20x20	7,5	1



**Set 3 recipientes**  
Set de 3 récipients · Set mit 3 Behältern  
Set with 3 containers · Conjunto com 3 recipientes

Ref	€	ml	cm	h (cm)	U.Venta
64607	38,70	800	18x13,5	7	1
		1200	20,5x15,5	7,5	
		1800	23x17,5	8	

# ECOINOX

## Colección



New



**Recipiente rectangular**  
Récipient rectangulaire · Rechteckbehälter  
Rectangular container · Recipiente retangular

Ref	€	ml	cm	h (cm)	U.Venta
64610	8,60	800	18x13,5	7	1
64611	10,60	1200	20,5x15,5	7,5	1
64612	13,20	1800	23x17,5	8	1



**Recipiente cuadrado**  
Récipient carré · Quadratischer Behälter  
Square container · Recipiente quadrado

Ref	€	ml	cm	h (cm)	U.Venta
64613	8,00	650	14x14	7	1
64614	11,40	1500	18,5x18,5	8	1



**Recipiente redondo**  
Récipient rond · Runder Behälter  
Round container · Recipiente redondo

Ref	€	ml	cm	h (cm)	U.Venta
64615	8,20	700	16x16	6,5	1
64616	12,30	1500	20x20	7,5	1



**Set 3 recipientes**  
Set de 3 récipients · Set mit 3 Behältern  
Set with 3 containers · Conjunto com 3 recipientes

Ref	€	ml	cm	h (cm)	U.Venta
64617	31,30	800	18x13,5	7	1
		1200	20,5x15,5	7,5	
		1800	23x17,5	8	

# COLADORES

## Colección

Inox  
18/10  
Dishwasher



### Colador chino

Passoire "Chinois" · Spitzsieb mit Flachstiel  
"Chinese" strainer · Passador chinês

Ref	€	Ø (cm)	U.Venta
60311	17,30	10	1
60313	17,80	12	1
60315	18,70	14	1
60317	20,40	16	1
60318	21,60	18	1
60320	23,40	20	1
60322	25,40	22	1
60324	26,70	24	1
60326	28,60	26	1



### Colador chino mango varilla

Passoire "Chinois" manche fil · Spitzsieb mit Rundstiel  
Wire handle "Chinese" strainer · Passador chinês cabo vareta

Ref	€	Ø (cm)	U.Venta
60316P	17,10	16	1
60318P	18,30	18	1
60320P	19,70	20	1
60322P	22,30	22	1
60324P	23,80	24	1



### Colador chino mango varilla

Passoire "Chinois" manche fil · Spitzsieb mit Rundstiel  
Wire handle "Chinese" strainer · Passador chinês cabo vareta

Ref	€	Ø (cm)	U.Venta
60316V	17,80	16	1
60319V	20,20	20	1



### Nidos de alambre

Panier à nid · Nestbacklöffel  
Bird's nest mould · Ninhos de arame

Ref	€	cm	L (cm)	U.Venta
62957	22,60	7-9	35	1
62959	26,40	9-11	37	1



### Colador 1/2 esfera

Passe-bouillon · Passiersieb  
Sieve · Coador 1/2

Ref	€	Ø (cm)	U.Venta
62680	5,20	8	1
62610	8,70	10	1
62612	11,20	12	1
62614	12,90	14	1
62616	15,20	16	1
62618	17,80	18	1
62620	23,10	20	1
62623	27,70	23	1



### Colador cónico

Passoire conique · Passiersieb, konisch  
Conical sieve · Coador cónico

Ref	€	Ø (cm)	U.Venta
62690	7,00	8	1
62611	9,20	10	1
62613	11,70	12	1
62615	14,50	14	1
62617	17,00	16	1
62619	19,50	18	1



### Colador

Passoire · Teigwaren-Einsatz  
Colander · Coador

Ref.	€	Ø (cm)	h (cm)	U.Venta
50334	69,50	36	23,0	1
50338	84,20	40	26,0	1

Precio unitario · Prix unitaire · Unit price

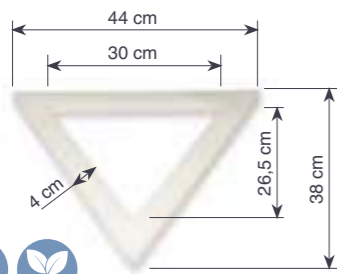

### Triángulo

Triangle · Dreieck  
Triangle · Triângulo

Ref.	€	h (cm)	mm	U.Venta
60402	55,30	2	400	1



Posibilidad de completar  
colador en 4 sectores  
solicitando 4 unidades

Possibility of completing  
strainer in 4 sectors  
requesting 4 units



### Colador

Passoire à queue · Seiher mit Stiel  
Strainer · Coador

Ref.	€	Ø (cm)	h (cm)	L	U.Venta
50320	55,70	20	12	3,5	1
50324	63,50	24	14	6,5	1
50328	74,40	28	15	9,3	1



### Mano chino

Poussoir à chinois · Holz-Stößel  
Chinese strainer pusher · Pilão p/passador chinês

Ref	€	L (cm)	U.Venta
60300	6,10	25	1



### Colador chino de malla

Passoire "Chinois" toile-metallique · Gazespitzsieb  
Meshed "Chinese" strainer · Coador chinês de rede

Ref	€	Ø (cm)	U.Venta
60319	27,80	18	1
60321	34,50	20	1
60323	34,90	22	1
60325	38,30	24	1



### Colador malla c/refuerzo

Chinois toile-metallique a croissillon ·  
Gewebedurchschlang, konisch, verstärkt  
Conical mesh strainer w/protection  
Coador de rede c/reforço

Ref.	€	Ø (cm)	U.Venta
62621	52,80	20x22	1

### Colador DRAIN

Passe-bouillon · Passiersieb  
Sieve · Coador

Ref	€	Ø (cm)	U.Venta
62697	5,20	7,5	6
62691	7,80	12,0	6
62698	12,40	18,0	1
62692	14,20	22,0	1



Mango de madera  
Wooden handle



### Colador doble malla

Passoir maillee · Passiersieb, stark  
Mesh strainer · Coador rede dupla

Ref	€	Ø (cm)	L (cm)	U.Venta
61316	8,10	16	32,0	1
61318	9,40	18	34,0	1
61320	11,00	20	37,0	1
61323	28,00	23	56,0	1
61326	30,50	26	58,0	1
61330	54,30	30	78,5	1
61335	65,50	35	84,0	1

**A** 2 Ganchos  
2 Hooks

**B** 1 Gancho  
1 Hook

**C** 1 Gancho  
1 Hook

Alambre estañado · Fil étamé · Tinned wire

# ESCURRIDORES

## Colección

Inox 18/10  
Dishwasher



Malla metálica donde se depositan los alimentos  
Metal mesh where food is deposited

Agujeros · Holes  
1x1 cm



Recipiente donde se recoge el aceite sobrante  
Container where excess oil is collected

### Escurrefritos

Passoire a friture · Abtropfschüssel für Frittiertes  
Fry colander · Escorre-fritos

Ref.	€	cm	h (cm)	U.Venta
50541	181,30	40x29	8,0	1
50551	213,90	50x39	8,0	1
50561	245,70	60x39	8,0	1

Ayuda a preparar rebozados perfectos  
Helps prepare perfect batters



Harina tamizada, para su recuperación  
Sifted flour, for its recovery

### Harinero

Tamis à farine à glissière · Mehlbehälter  
Flour bin mesh · Farinheiro

Ref.	€	cm	h (cm)	U.Venta
50438	162,70	37x26,5	18	1
50450	167,90	50x26,5	18	1

# EMBUDOS

## Colección

Inox 18/10  
Dishwasher

Cuello ancho para verter con mayor rapidez en tarros/botellas sin riesgo de quemaduras  
Wide neck for faster pouring into jars / bottles without risk of burns



### Escurreidera con base

Passoire sur pied · Abtropfschüssel mit Fussreif  
Colander with stand · Escorredora com base

Ref.	€	Ø (cm)	h (cm)	L	U.Venta
50332	216,80	32	18	9,5	1
50336	263,50	36	19	12,0	1
50340	308,70	40	21	14,5	1



### Escurreidera cónica con base

Passoire conique sur pied · Abtropfschüssel  
Conical colander with stand · Escorredor cónico com base

Ref	€	Ø (cm)	h (cm)	L	U.Venta
50829	70,70	28	17	13,2	1
50833	77,60	32	20	14,5	1
50837	88,40	36	23	16,0	1
50841	95,70	40	26	18,0	1
50846	109,70	45	29	20,0	1
50851	124,80	50	33	22,0	1



Ranura de  
desgasificación  
Filtro  
Degassing groove  
Filter



### Embudo

Entonnoir · Trichter  
Funnel · Funil

Ref	€	Ø (cm)	U.Venta
62512	15,70	12	1
62516	22,70	16	1
62521	29,40	20	1
62524	32,90	24	1



### Embudo mermelada

Entonnoir à confiture · Mermeladentrichter  
Funnel for jam · Funil de congestionamento

Ref	€	Ø (cm)	h (cm)	A (Øcm)	U.Venta
62517	10,00	13,5	6,5	6	1

Inox garinox®



### Escurreidera

Passoire · Abtropfschüssel  
Colander · Escorredor

Ref	€	Ø (cm)	L	U.Venta
14122	18,40	22	3,0	1
14125	22,60	25	5,0	1
14130	32,70	30	8,0	1

Varillas extensibles  
Extendable rods



### Escurreidor extensible para fregadera

Passoire extensible pour l'évier · Spülbank-Sieb, ausziehbar  
Extendable sink strainer · Escorredor extensível para bancada

Ref	€	cm	Max (cm)	U.Venta
62987	24,00	34x24	55x24	1



Ranura de  
desgasificación  
Filtro extraíble  
Degassing groove  
Removable filter



### Embudo con filtro

Entonnoir à filtre mobile · Trichter mit Sieb  
Funnel with movable filter · Funil com filtro

Ref	€	Ø (cm)	A (Ø cm)	U.Venta
62531	12,80	10	1,2	1
62513	15,00	12	1,5	1
62515	17,20	14	1,5	1

Si 180 °C BPA free

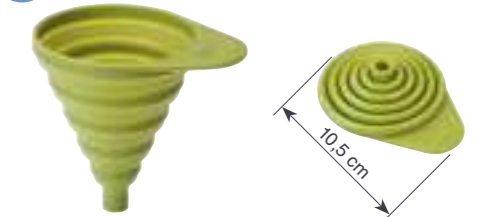

### Embudo expandible

Entonnoir extensible · Trichter  
Foldable funnel · Funil extensível

Ref	€	Ø (cm)	h (cm)	U.Venta
68085	5,90	8	10,5	1

# HERVIDORES

## Colección

Inox  
18/10  
Dishwasher



### Hervidor extensible

Panier marguerite extensible · Kocher, ausdehnbar, Rostfrei  
Extendable steamer · Grelha extensível

Ref	€	Ø (cm)	U.Venta
60349	6,70	24	12
60348	9,80	28	6



### Cuece especias

Diffuseur épices · Kräterkochsieb  
Spice cooker · Cozedor de especiarias

Ref	€	Ø (cm)	h (cm)	U.Venta
62958	12,30	4	15,4	1

New

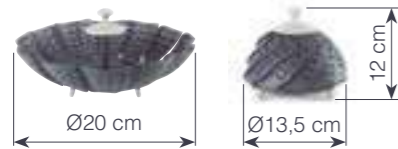

### Hervidor extensible FLOR

Panier marguerite extensible · Kocher, ausdehnbar, Rostfrei  
Extendable steamer · Grelha extensível

Ref	€	Ø (cm)	h (cm)	U.Venta
60288	8,00	13,5-26	12	1



PP  
polypropylene  
BPA free

- Fabricado en polipropileno de máxima calidad, altamente resistente al calor, libre de BPA.
- Diseñado para cocinar los alimentos al vapor preservando todos sus nutrientes y vitaminas.
- Se adapta a diferentes tamaños de ollas gracias a sus hojas plegables.
- Almacenaje compacto; se pliega fácilmente y ocupa poco espacio.
- Tres pies antideslizantes de 2,5 cm de altura que no rayan la base de la olla. Pomo para una extracción segura.

- Fabriqué en polypropylène de la plus grande qualité, hautement résistant à la chaleur, sans BPA.
- Conçu pour faire cuire les aliments à la vapeur en préservant tous leurs nutriments et vitamines.
- S'adapte à différentes tailles de casseroles grâce à ses ailettes pliables.
- Rangement compact ; se plie facilement et prend peu de place.
- Trois pieds antidérapants de 2,5 cm de hauteur qui ne rayent pas le fond de la casserole. Poignée pour une extraction en toute sécurité.

- It's made of top quality BPA free polypropylene with high heat resistance.
- It's designed for steaming food and preserving all the vitamins and nutrients.
- It can fit different sizes of pots because of its collapsible leaves.
- Compact Storage: easy to fold and doesn't take up a lot of space.
- It has three 2.5 cm tall non-slip feet that won't scratch the bottom of the pot Knob for safe and secure removal.



### Cacerola vapor

Panier vapeur · Dampfkoch-Aussatz o/Untertopf  
Steam casserole · Caçarola a vapor

Ref	€	Ø (cm)	h (cm)	U.Venta
50428	58,90	28	11,0	1
50432	65,00	32	12,5	1



### Hervidor pescado

Poissonniere avec grille · Fischkochkessel mit Einsatz  
Fish kettle with grill · Peixeira

Ref.	€	cm	h (cm)	L	U.Venta
50440	102,80	40x19	11	10,05	1
50445	108,50	50x17	11	13,80	1
50460	141,70	60x19	11	20,80	1

# HUEVO

## Colección

Inox  
18/10  
Dishwasher



Asegura una separación limpia  
Ensures clean separation



### Separador de claras

Séparateur à oeuf · Eier-Separator  
Eggs separator · Separador de ovos

Ref	€	U.Venta
61608	7,80	6



### Soporte huevo OVUM

Support d'oeufs · Eierbecher  
Egg stand · Suporte de ovo

Ref	€	Ø (cm)	h (cm)	U.Venta
68285	2,90	4,5	5	6

Si  
Silicone  
BPA free

Mango abatible  
Folding handle

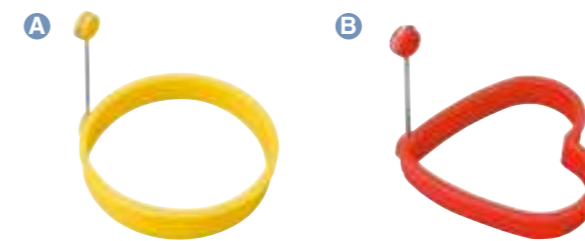

### Molde huevo

Moule à oeufs · Eierform  
Egg mould · Molde ovo

	Ref	€	cm	U.Venta
A	68080	6,10	Ø10x2	1
B	68082	6,10	10,5x10,5x2	1

Inox

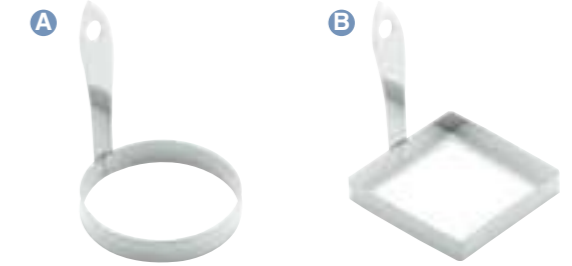

### Molde huevo-sándwich

Moule à oeufs-sandwich · Eier-/Sandwichring  
Mould for egg-sandwich · Molde ovo-Sandwich

	Ref	€	cm	U.Venta
A	68005	3,20	Ø8,5	12
B	68006	3,20	8,5x8,5	12



# CORTADORES

## Colección



ES

- Picadora de mecanismo manual que pica todo tipo de alimentos, como verduras, frutas, frutos secos, dátiles, jengibre, ajo, cebolla, hierbas, etc.
- Incluye tres potentes cuchillas ultrarresistentes fabricadas en acero inoxidable de máxima calidad.
- Práctico y muy fácil de usar: con tal solo tirar del asa las cuchillas se activan.
- Corta con precisión y homogéneamente.
- Asa ergonómica y base antideslizante 100% segura.
- Ocupa poco espacio ya que su asa-tirador se pliega sobre la tapa de la picadora.
- Pequeño, compacto y muy fácil de limpiar.

FR

- Hachoir à mécanisme manuel qui hache tout type d'aliments, comme les légumes, les fruits secs, les dattes, le gingembre, l'ail, les oignons, les herbes, etc.
- Il possède trois puissantes lames ultra-résistantes fabriquées en acier inoxydable de la plus grande qualité.
- Pratique et très facile à utiliser : il suffit de tirer de la poignée pour activer les lames.
- Coupe avec précision et de façon homogène.
- Poignée ergonomique et base antidérapante 100% sûre.
- Prend peu de place car sa poignée se replie sur le couvercle du hachoir.
- Petit, compact et très facile à nettoyer.

EN

- Manual chopper that chops all kinds of food, like vegetables, fruit, nuts, dates, ginger, garlic, onion, herbs, etc.
- It includes three ultra-strong blades made of top quality stainless steel.
- Practical and very easy to use: The blades are activated by simply pulling the handle.
- It cuts precisely and evenly.
- It has an ergonomic handle and a 100% safe non-slip base.
- It doesn't take up much space because the handle-pull folds onto the chopper lid.
- It's small, compact and very easy to clean.

3 cuchillas SpinPro ultrarresistentes de acero inoxidable  
3 SpinPro blades ultra-resistant stainless steel



**Cortador manual AFFILATO**  
Coupe manuel · Manuelle Schneider  
Manual chopper · Cortador manual

Ref	€	Ø (cm)	h (cm)	L	U.Venta
60599	24,90	13	14	1,2	1



**Velocidad I · Speed I**  
**Corta y pica más grueso**  
Cut and chop more coarsely



**Corta alimentos duros**  
It cuts thicker foods



**Velocidad II · Speed II**  
**Corta y pica más fino**  
Cut and chop more finely



**Corta alimentos blandos**  
It cuts softer foods

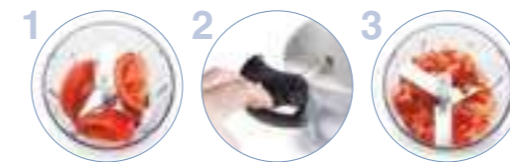

**Pica y corta alimentos en segundos**  
It chops and slices foods in seconds

[Click here](#)



**3 cuchillas ultrarresistentes**  
3 ultra-strong blades

A



B



### Cortador manual SHARP

Coupe manuel · Manuelle Schneider  
Manual cutter · Cortador manual

	Ref	€	Ø (cm)	h (cm)	L	U.Venta
A	60299	21,10	12	11	0,5	1
B	60499	22,40	13	14	1,0	1

- 2 en 1: cortador de verduras y cortador para preparar patatas Hasselback.
- Ideal para cortar en rodajas cualquier tipo de alimento como patata, cebolla, tomate, pepino, zanahoria e incluso carne y pescado.
- Mango antideslizante para un agarre firme y pinchos que guían el cuchillo para un corte perfecto y uniforme.
- Fácil de limpiar. Apto para el lavavajillas.

- 2 en 1 coupe-légumes et coupe-pommes de terre pour préparer des pommes de terre Hasselback.
- Idéal pour couper en rondelles tout type d'aliments comme les pommes de terre, les tomates, les concombres, les carottes et même la viande et le poisson.
- Manche antidérapant pour une prise en main ferme et des pointes qui guident le couteau pour une découpe parfaite et uniforme.
- Facile à nettoyer. Convient au lave-vaisselle.

- 2 in 1: vegetable slicer and Hasselback potato slicer.
- Ideal for slicing any type of food such as potatoes, onions, tomatoes, cucumbers, carrots and even meat and fish.
- Non-slip handle for a firm grip and skewers that guide the knife for perfect and even slicing.
- Easy to clean. Suitable for the dishwasher.

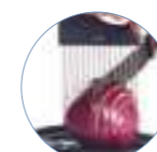

### Cortador de patatas HASSELBACK

Coupe-pommes de terre Hasselback · Hasselback-Kartoffelschneider  
Hasselback potato slicer · Cortador de batatas Hasselback

Ref	€	cm	h (cm)	U.Venta
68180	9,60	18x10	2,1	1



**3 cuchillas (6 - 9 - Rodajas 6 mm)**  
**2 empujadores**  
**Peines de limpieza**  
3 blades (6 - 9 - Slice 6 mm)  
2 pushers  
Cleaning combs



### Cortador de verdura y chips

Coupe de légumes · Gemüseschneidemaschine  
Chips and vegetable cutter · Cortador de verdura e chips

Ref	€	cm	h (cm)	U.Venta
60344	45,30	11,5x21,5	11	1

- Funcionamiento sencillo; insertar el tallo en el agujero que mejor se adapte y deslizar la rama en dirección contraria.
- Contiene agujeros de distinto tamaño:
  - a.- Los pequeños para deshojar hierbas aromáticas como el romero, orégano, tomillo, estragón, etc.
  - b.- Los más grandes para separar el tallo más duro que tienen algunas verduras de la hoja como las acelgas, espinacas, col rizada, etc.
- Gracias a la parte más aguda, se pueden cortar las hojas con el mismo utensilio.

- Easy to use. Put the stalk into the hole where it fits best and pull the herb in the opposite direction.
- There are different sized holes:
  - a.- The small holes are for stripping leaves from aromatic herbs like rosemary, oregano, thyme, tarragon, etc.
  - b.- The bigger holes are for separating harder stalks found in some leafy vegetables like chards, spinach, kale, etc.
- With the sharp end you can use the same utensil to cut leaves.



**Parte aguda para cortar**  
Sharp part for cutting

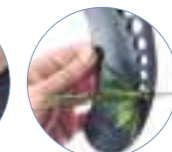

**Separador de hojas**  
Separating leaves



2 in 1

### Deshojador de hierbas aromáticas

Effeuilleuse à herbes aromatiques · Entblätterer für gewürzkräuter  
Aromatic herb stripper · Desfolhador de ervas aromáticas

Ref	€	cm	U.Venta
61359	6,50	16,5x7,5x2	1



# PICADORES

## Colección



ES

- Picadora de mecanismo manual que pica todo tipo de alimentos, como verduras, frutas, jengibre, ajo, cebolla, frutos secos y hierbas.
- Cuchilla de acero inoxidable de máxima calidad.
- Recipiente transparente para visualizar el proceso. Libre de BPA.
- Muy fácil y cómodo de usar gracias a su sistema manual PressTurn.
- Tapa de polietileno antideslizante para facilitar la tarea y evitar desplazamientos.
- Fácil de desmontar y limpiar.

FR

- Hachoir à mécanisme manuel qui hache tout type d'aliments, comme les légumes, les fruits, le gingembre, l'ail, l'oignon, les fruits secs et les herbes.
- Lame en acier inoxydable de la plus grande qualité.
- Récipient transparent. Sans BPA.
- Très facile et pratique à utiliser grâce à son système manuel PressTurn.
- Couvercle antidérapant pour faciliter la tâche et éviter les glissements.
- Facile à démonter et à nettoyer.

EN

- Hand-operated food processor for chopping all types of food, such as vegetables, fruit, ginger, garlic, onion, nuts and herbs.
- Top quality stainless steel blade.
- Transparent jar for easy viewing. BPA free.
- Very simple, easy to use manual PressTurn.
- Non-slip lid to simplify the process and avoid slipping.
- Easy to dismantle and clean.



Diseño compacto  
Compact design



**Picadora manual PRESS**

Hachoir manuel · Handschneider  
Manual food chopper · Picador manual

Ref	€	Ø (cm)	h (cm)	U.Venta
62819	35,70	9,4	22,7	1



**Picadora manual**

Hachoir manuel · Handschneider  
Manual food chopper · Picador manual

Ref	€	Ø (cm)	h (cm)	U.Venta
62980	31,90	9,5	22	6



**Picaperejil**

Hachoir à manivelle pour fines herbes · Kräutermühle, fein  
St. steel fine herbs mincer · Pica-salsa

Ref	€	cm	U.Venta
60334	22,30	13,5x20x7,5	1

Inox



**Picadora de carne manual**

Hachoir avec manivelle · Fleischwolf mit handkurbe  
Meat mincer · Picadora de carne manual

Ref	€	cm	U.Venta
60329	123,80	17x12x19	1

Multifuncional: pica, bate y centrifuga  
Mecanismo de manivela  
que requiere muy poca fuerza  
Multifunctional: chop, beat and spin  
Crank mechanism requiring very little force

Sistema TurnCut  
Accionamiento manual de la manivela  
100% estable. Sujeción mediante ventosa  
TurnCut System  
Manual crank operation  
100% stable. Suction cup fastening

Inox ABS plastic



**Picadora**

Mincer · Fleischwolf  
Hachoir · Picadora

Ref	€	cm	U.Venta
60340	34,70	18x22	1

**Mini picadora-batidora manual**

Mini hachoir-fouet manuel · Minizerhacker-Schneebeesen  
Manual mini chopper-whisk · Mini picadora-batedeira manual

Ref	€	Ø (cm)	L	U.Venta
60361	18,10	Ø17x18	1,00	1

# TOMATE

## Triturador

ES

- Saca el máximo jugo a los alimentos, libre de pieles y semillas.
- Filtro de acero inoxidable de gran calidad y contenedor de polipropileno, libre de BPA.
- Superversátil: prepara salsas de tomate, purés de patata, mermeladas, conservas, etc. con un único aparato.
- Entrada de alimentación de gran capacidad.
- Dispone de un orificio de salida para desechos.
- 100% estable: sistema de sujeción mediante ventosa.
- Incluye empujador para facilitar y agilizar el procesado.
- Totalmente desmontable y fácil de limpiar.

FR

- Recueillir au maximum le jus des aliments, sans peaux ni pépins.
- Filtre en acier inoxydable de grande qualité et conteneur en polypropylène, sans BPA.
- Très polyvalent: préparer des sauces tomate, des purées, des confitures, des conserves, etc. avec un seul appareil.
- Entrée d'aliments de grande capacité.
- Dispose d'un orifice de sortie pour déchets.
- 100% stable: système de fixation via des ventouses.
- Inclut un poussoir pour faciliter et accélérer le processus.
- Entièrement démontable et facile à nettoyer.

EN

- Designed to get the most juice out of food with no peels or seeds.
- It has a high quality stainless steel filter and a BPA free polypropylene container.
- Extremely Versatile: make tomato sauces, potato purée, marmalade, preserves, etc. with a single appliance.
- High capacity food input
- It has an outlet for waste.
- 100% Stable: it has an attachment system that uses suction cups.
- A pusher is included to make processing food faster and easier.
- It can be completely disassembled and it's very easy to clean.



Incluye empujador  
Salida para desechos  
Salida de jugo, libre de pieles y semillas  
Includes pusher  
Outlet for waste  
Juice outlet with no peels or seeds

**Triturador manual de tomate**

Presse-tomates manuel · Handpresse für Tomaten  
manual tomato chopper · Triturador manual de tomate

Ref	€	U.Venta
60394	47,20	1

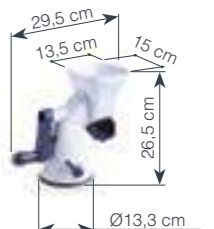

# OSO Garras

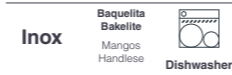

ES

- Fabricadas en acero inoxidable de máxima calidad.
- Diseñadas para desmenuzar y manipular carnes hechas al horno o barbacoa, como pollo, carne de vacuno, pavo, aves, jamón, etc.
- Puntas afiladas para manipular la carne sin esfuerzo. Forma curvada para un mejor agarre y mayor comodidad.
- Mangos ergonómicos de baquelita resistentes al calor, 100% seguros.
- Multifuncional: desmenuza y traslada la carne, facilita la sujeción para cortes con cuchillo, remueve las ensaladas o pastas, etc.
- Fácil de limpiar. Aptas para el lavavajillas.

FR

- Fabriquéees en acier inoxydable de la plus grande qualité.
- Conçues pour émincer et manipuler des viandes cuites au four ou au barbecue comme du poulet, du boeuf, de la dinde, de la volaille, du jambon, etc.
- Pointes aiguisées pour manipuler la viande sans effort. Forme courbée pour une meilleure prise en main et un plus grand confort.
- Poignées ergonomiques en bakélite résistantes à la chaleur, 100% sûres.
- Multifonctions : émincer et transférer la viande, faciliter la prise en main pour une découpe au couteau, remuer les salades ou les pâtes, etc.
- Facile à nettoyer. Aptes pour le lave-vaisselle.

EN

- Made of top quality stainless steel.
- Designed for shredding and handling baked or barbecued meats, such as chicken, beef, turkey, poultry, ham, etc.
- Sharp tips for easy handling of meats. Curved shape for better grip and comfort.
- Ergonomic heat-resistant Bakelite handles, 100% safe.
- Multifunctional: perfect for shredding, turning and holding meat in place while cutting it with a knife, ideal for mixing salads or pasta, etc.
- Easy to clean. Dishwasher safe.

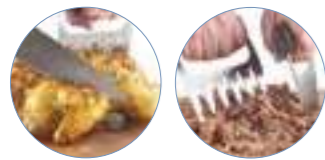

**Manipula carnes**  
**Desmenuza carnes**  
Manipulate meat  
Crumble meats

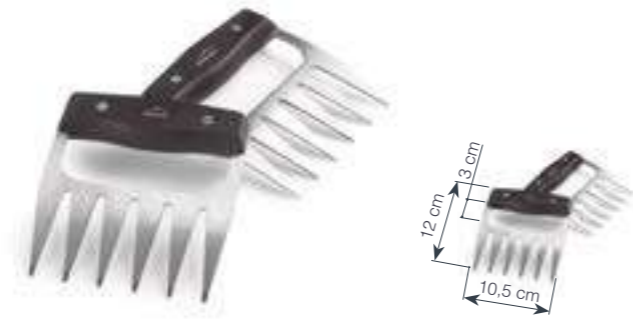

## Garras de oso para carne

Griffes à viande · Fleisch Bärenkrallen  
Bear claws for meat · Garras de urso para carne

Ref	€	cm	U.Venta
38015	12,70	10,5x12	1

# PASAPURÉS Colección



2 Discs



2 Discs



3 Discs



2 Discs

## Pasapurés

Presse-Puree · Passiergerät  
Potato mashing machine · Passa-puré professional

	Ref.	€	Ø (cm)	L	Ø Disco (cm)	U.Venta
A	60026	124,20	26	5,0	16,5	1
B	60031	129,80	32	8,0	16,5	1
B	60030	82,40	30	3,5	16,5	1
C	60048	55,10	18	0,7	10,5	1
C	60027	72,40	24	1,5	13,5	1
D	60021	55,90	20	1,5	11,5	1

# MORTEROS Colección



ES

- Fabricados en granito de calidad premium.
- Interior no poroso, permite extraer los aceites naturales de las hierbas y especias.
- El diseño de la mano permite maniobrar con facilidad y con poco esfuerzo.
- Pesado y bien balanceado.

FR

- Composé de granit de qualité supérieure.
- Intérieur non poreux permettant d'extraire les huiles essentielles des herbes et épices.
- La conception de la main facilite les manœuvres et réduit lrs efforts.
- Lourd et bien équilibré.

EN

- Manufactured from premium quality granite.
- Interior not porous allowing extracting natural oils from herbs and spices.
- The design of the hand allows easy manoeuvres with little effort.
- Heavy and well balanced.



## Mortero con mano de granito

Mortier et pilon en granit · Mörser und Stößel aus Granit  
Granite mortar and pestles · Argamassa e pilão do granito

	Ref	€	Ø (cm)	h (cm)	ml	U.Venta
A	60512	25,80	12,0	8,0	250	1
B	60514	30,10	14,0	10,0	375	1
B	60516	31,30	16,0	12,0	600	1
C	60517	25,00	10,5	7,5	225	1
D	60518	25,40	12,0	12,0	365	1



## Mano mortero

Poussoir à mortier · Stößel  
Pestle · Pilão p/almofariz

Ref.	€	Ø (cm)	U.Venta
60401	39,20	Ø4,8x25	1



## Mortero

Mortier · Mörser  
Mortar · Almofariz

Ref.	€	Ø (cm)	U.Venta
60403	160,70	18	1

# PRENSADORES

## Colección

Inox  
18/10  
Dishwasher



**Prensador de patatas**  
Presse-purée · Kartoffelpresse  
Potato masher · Prensa-batatas

	Ref	€	cm	h (cm)	U.Venta	
A	62896	17,90	ø11,6	45,5	1	New
B	62892	19,40	10,5x8,5	24,0	1	
C	62897	8,50	11x7,5	17,5	1	New

- Fabricado en acero inoxidable 18/10 de alta calidad y gran resistencia.
- Tritura sin esfuerzo cualquier alimento cocinado previamente o de textura blanda.
- Ideal para preparar puré de patata, tomate, calabaza, plátano, etc.
- Superficie de prensado diseñado para conseguir un acabado homogéneo.
- No transmite olores ni sabores a los alimentos.

- Fabriqué en acier inoxydable 18/10 de grande qualité et d'une résistance maximale.
- Triture sans effort tout aliment préalablement cuit ou à texture molle.
- Idéal pour préparer de la purée de pomme de terre, de courge, de banane, etc.
- Surface de pressage conçue pour obtenir un résultat homogène.
- Ne transmet ni odeurs ni goûts aux aliments.

- Made of top quality, high resistance 18/10 stainless steel.
- Easily mashes any pre-cooked or soft-textured foods.
- Ideal for mashing potatoes, tomatoes, pumpkin, bananas, etc.
- Mashing surface designed for even mashing, giving perfect results.
- Does not transmit odours or flavours.



**Prensa patatas**

Presse-pomme de terre · Kartoffelpresse  
Potato press · Esmaga-batatas

Ref	€	cm	U.Venta
62902	34,90	9x28x11	1



**Molde empanadillas**

Moule à chaussons · Pastetenformen  
Dumpling mould · Forma para salgados

Ref	€	Ø (cm)	U.Venta
68101	20,90	10	1
68102	22,90	12	1

**Pica y lamina**  
Chop and slice

**Accesorio para eliminar los restos**  
Accessory for eliminating the remains



**Prensa ajos y laminador**

Presse ail coupe · Knoblauchpresse, Schneider  
Garlic press and slicer · Esmaga-alhos y laminador

Ref	€	L (cm)	U.Venta
60387	26,40	20	1



**Resultados perfectos. Empanadillas iguales y perfectamente selladas**  
Perfect results. Equal and perfectly sealed dumplings

# ABLANDACARNES

## Colección

Inox  
18/10  
Dishwasher

- Sólida, robusta y especialmente pesada (734 g) para ablandar, aplanar y ensanchar fácilmente todo tipo de carnes.
- Gran superficie de aplastado con un espesor de 12 mm.
- Mango robusto ergonómico para un fácil manejo con práctica presilla para colgar.
- Higiénica e inodora, no absorbe los olores de los alimentos.

- Solide, extrêmement robuste et spécialement conçu (734 g) pour attendrir, aplatir et élargir facilement tout type de viande.
- Grande surface de travail avec une épaisseur de 12 mm.
- Manche robuste et ergonomique pour une prise en main facile et un crochet pratique pour le suspendre.
- Hygiénique et inodore, il n'absorbe pas les odeurs des aliments.

- Solid, extremely robust and specially designed (734 g) to easily tenderise, flatten and widen all types of meat.
- Large 12 mm thick flattening surface.
- Sturdy, ergonomic handle for firm grip and easy handling.
- Features a practical hanging eye.
- Hygienic and odourless: does not absorb odours or flavours.

New



**Maza ablandacarne**

Attendrisseur de viande · Fleischhammer  
Meat mallet · Maço para amciar carne

Ref	€	cm	h (cm)	U.Venta
61251	25,10	27x8	5,0	1

**Liso para reducir el grosor de la carne.**  
**Rugoso para ablandar y para que penetre mejor los adobos**  
Smooth side, to reduce the thickness of the meat.  
Rough side for softening and better marinade penetration



**Mango ergonómico y antideslizante**  
Ergonomic non-slip handle

**Martillo ablandacarne**

Marteau attendrisseur de viande · Fleischklopper Hammer  
Meat hammer tenderizer · Martelo ablandador de carne

Ref	€	cm	U.Venta
60431	16,90	7x24	1

- 48 cuchillas extremadamente afiladas fabricadas en acero inoxidable.
- Las cuchillas crean pequeños canales térmicos dentro de la carne, permitiendo que el calor penetre y se distribuya uniformemente.
- Ideal para preparar todo tipo de carnes para que queden más jugosas, sabrosas y blandas.
- Las cuchillas se retraen automáticamente al dejar de presionar.
- Mango ergonómico antideslizante, garantiza un agarre seguro y eficiente.
- Diseño seguro con cubierta protectora.

- 48 lames extrêmement aiguës fabriquées en acier inoxydable.
- Les lames créent de petits canaux thermiques dans la viande, permettant ainsi à la chaleur de pénétrer et de se répandre uniformément.
- Idéal pour préparer tout type de viandes afin qu'elles soient juteuses, savoureuses et tendres.
- Les lames se rétractent automatiquement dès que l'on cesse d'appuyer sur l'appareil.
- Manche ergonomique antidérapant qui garantit une prise en main sûre et efficace.
- Conception sûre avec couvercle de protection.

- 48 extremely sharp high quality stainless steel blades.
- The blades create small heat channels in the meat, ensuring even heat absorption and distribution.
- Ideal for cooking all kinds of meat for more succulent, tender and juicy dishes.
- The blades retract automatically when you stop pressing.
- Ergonomic, non-slip handle for a comfortable, safe grip.
- Safe design with protective cover.

New



48  
Blades

**Maza ablandacarne BLACK**

Attendrisseur de viande · Fleischhammer  
Meat mallet · Maço para amciar carne

Ref	€	Cuchillas (cm)	U.Venta
61250	8,90	6x3	1



16  
Blades

**Ablandacarne INOX**

Attendrisseur à viande en Inox · Fleischklopper, Edelstahl  
St. steel meat tenderizer · Ablandacarne Inóx

Ref	€	cm	U.Venta
60432	37,70	12x2	1

# PRENSA HAMBURGUESAS

## Colección



**Presna hamburguesas**  
 Presse à hamburguers · Hanburger-Formen  
 Hamburg presser · Moldes para hamburgüeres

Ref	€	Ø (cm)	U.Venta
60258	14,60	11,5x7,5	1
R60258A	1,50	11	1

60 separadores separators



- Molde de aleación de aluminio fundido de gran calidad con recubrimiento antiadherente.
- Pomo de madera desmontable y ergonómico, permite una distribución uniforme de la presión para crear hamburguesas caseras de carne, vegetarianas o veganas.
- Perfectas en proporción y consistencia.
- Superficie interior acanalada, proporciona un aspecto profesional.
- Incluye 60 unidades de papel antiadherente de Ø11 cm.
- Fácil de limpiar.

- Moule en alliage de fonte d'aluminium de grande qualité avec revêtement anti-adhésif.
- Pommeau en bois démontable et ergonomique, permet une distribution uniforme de la pression pour créer des steaks à hamburger maison de viande, végétariens ou végans.
- Proportion et consistance parfaites.
- Surface interne cannelée, qui confère un aspect professionnel.
- Comprend 60 unités de papier antiadhésif Ø11 cm.
- Facile à nettoyer.

- High quality cast aluminum alloy mold with non-stick coating.
- Removable ergonomic wooden handle, facilitates uniform distribution of pressure to make homemade beef, vegetarian or vegan burgers.
- Perfect proportions and consistency.
- Ribbed inner surface, provides a professional appearance.
- Includes 60 units of Ø11 cm non-stick paper.
- Easy to clean.

**New**

Separadores · Separators



- Fabricado en aluminio fundido anodizado y acero inoxidable 18/10.
- Firme, robusto y resistente.
- Diseñado para un uso profesional intensivo y continuado; ideal para carnicerías, hamburgueserías, restaurantes, etc.
- Diámetro de la hamburguesa: Ø100 mm (60226)/130 mm (60227). Forma uniforme.
- Funcionamiento manual: mecanismo de palanca.
- Mecanismo de extracción rápida: extrae la hamburguesa con total facilidad.
- Depósito para almacenar las hojas separadoras y tenerlas a mano mientras se elaboran las hamburguesas.
- Pies de goma antideslizantes: máxima estabilidad durante el uso.
- Incluye 500 unidades de papel antiadherente perforado de Ø10/13 cm (evita que la carne se pegue a la hora de retirar el papel).

- Fabriqué en fonte d'aluminium anodisé et en acier inoxydable 18/10.
- Stable, robuste et résistante.
- Conçue pour un usage professionnel intensif et continu ; idéale pour les boucheries, les établissements de hamburgers, les restaurants, etc.
- Diamètre du steak haché : Ø100 mm (60226)/130 mm (60227). Forme uniforme.
- Fonctionnement manuel : mécanisme à levier.
- Mécanisme d'extraction rapide : extrait le steak haché avec une grande facilité.
- Compartiment pour ranger les feuilles de séparation et les avoir à portée de main pendant l'élaboration des steaks hachés.
- Pieds en caoutchouc antidérapant : stabilité maximale pendant l'utilisation.
- Inclut 500 unités de papier antiadhésif perforé de Ø10/13 cm (évite que la viande colle lors du retrait du papier).

- Made of anodized cast aluminium and 18/10 stainless steel.
- Rigid, robust and strong.
- Designed for intensive continuous professional use, and perfect for butcher shops, hamburger and other restaurants, etc.
- Patty diameter Ø100 mm (60226)/130 mm (60227) Consistent shape.
- Manual Operation: lever mechanism.
- Quick Release Mechanism: Patties can be removed very easily.
- Holder for storing separator sheets and keeping them handy when you're making patties.
- Non-slip Rubber Feet: Maximum stability during use.
- Includes 500 Ø10/13 cm sheets of non-stick paper with holes to keep the meat from sticking when the paper is removed.



**Presna hamburguesas MULTI**  
 Presse à hamburguers · Hanburger-Formen  
 Hamburg presser · Moldes para hamburgüeres

Ref	€	Ø (cm)	U.Venta
60259	7,30	12,5x6	1
R60259A	1,40	10	1

60 separadores separators



Paso a paso... / Pas à pas... / Step by step...

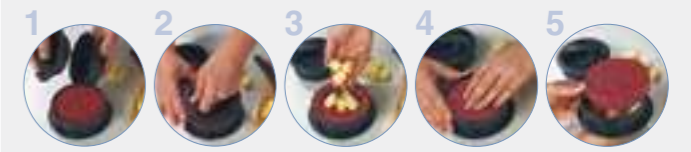

- Fabricado en plástico ABS de alta calidad y durabilidad. Libre de BPA.
- Compuesto por 6 piezas totalmente desmontables.
- Versátil: ideal para preparar y rellenar todo tipo de hamburguesas.
- Base extraíble acanalada para facilitar la extracción de la hamburguesa.
- Compacto: se guarda en una sola pieza.
- Práctico y muy fácil de usar.
- Medidas (mm): hamburguesa grande Ø10x3 cm / mini Ø6,5x2 cm.
- Incluye 60 unidades de papel antiadherente de Ø10 cm.
- Fácil de limpiar. Apto para el lavavajillas.

- Fabriqué en plastique ABS d'une grande qualité et durabilité. Sans BPA.
- Composée de 6 pièces entièrement démontables.
- Polyvalente : Idéale pour préparer et garnir tout type de hamburgers.
- Base extractible cannelée pour faciliter l'extraction du steak.
- Compacte : Se range en une seule pièce.
- Pratique et très facile à utiliser.
- Dimensions (mm) : Grand steak Ø10x3 cm/Mini steak mini Ø6,5x2 cm.
- Comprend 60 unités de papier antiadhésif Ø10 cm.
- Facile à nettoyer. Apte pour le lave-vaisselle.

- Made of high quality, durable ABS plastic. BPA free.
- Comprised of 6 fully detachable parts.
- Fully versatile: perfect for making and filling all types of burgers.
- Detachable grooved base to simplify burger extraction.
- Compact: single piece storage.
- Very practical and easy to use
- Dimensions (in mm): Large burger Ø10x3 cm/Mini burger Ø6,5x2 cm.
- Includes 60 units of Ø10 cm non-stick paper.
- Easy to clean. Dishwasher safe.

# EXPRIMIDORES MANUALES

## Colección

Inox 18/10  Dishwasher

Disfruta del zumo recién exprimido

Enjoy freshly squeezed juice



ES

- Ideales para limas, limones, naranjas e incluso pomelos.
- Extraen el jugo sin cascaras, pulpa y semillas.

FR

- Idéales pour les citrons verts, les citrons jaunes, les oranges et même les pamplemousses.
- Extrait le jus sans peau, pilpe ou graines.

EN

- Ideals for limes, lemons, oranges and even grapefruit.
- Extracts the juice without peel, pulp and seeds.

Medidor (ml/cup)  
Measure (ml/cup)

PMMA plastic Jarra/Jug  
PP polypropylene Cazo/Cone  
BPA free

AS plastic Jarra/Jug  
ABS plastic Cazo/Cone  
BPA free



**Exprimidor manual**  
Presse citron manuel · Manuelle zitronenpresse  
Manual reamer · Espremedor manual

Ref	€	cm	h (cm)	L	U.Venta
A 68181	6,40	10x9,5	8,5	0,07	1
B 67134	7,30	18,5 x11	15,0	0,50	1

Inox



**Exprimidor manual INOX**

Presse citron manuel · Manuelle zitronenpresse  
Manual reamer · Espremedor manual

Ref	€	Ø (cm)	L	U.Venta
62952	17,60	10	0,15	6
62912	20,60	12	0,20	6

**Exprimidor de zumo**

Presse-fruits manuel · Manuelle fruchtresse  
Manual squeezer · Espremedor de sumos

Ref	€	cm	h (cm)	U.Venta	
A 63913	58,30	21x18	21	1	Bajo · Low
B 63914	53,70	15x19	39	1	Alto · High

B **Inox 18/10**



**New**

A **AL Aluminium**

**3 in 1**



**Exprimidor manual**  
Presse citron manuel · Manuelle zitronenpresse  
Manual reamer · Espremedor manual

Ref	€	L (cm)	U.Venta
A 63915	11,10	22	1
B 68182	25,80	22	1

**New**

- Excelente resistencia a la corrosión; no se oxida o reacciona a los jugos de los cítricos.
- Ideales para exprimir limas, limones y naranjas.
- Superficie acanalada para extraer el máximo jugo.
- Mango ergonómico para un fácil exprimido y un menor esfuerzo.
- Apto para el lavavajillas.

- Excellente résistance à la corrosion ; ne rouille pas et n'est pas réactif au jus des agrumes.
- Idéales pour presser des limes, citrons et des oranges.
- Surface cannelée pour extraire au maximum le jus.
- Manche ergonomique pour un pressage simple et un effort minimum.
- Compatible avec le lave-vaisselle.

- It has excellent corrosion resistance and does not rust or react to citrus juice.
- It's perfect for squeezing limes, lemons and oranges.
- Grooved surface for maximum juice extraction.
- It has an ergonomic handle to make squeezing juice easy and almost effortless.
- Dishwasher safe.





**Exprimidor manual FLOR**  
Presse citron manuel · Manuelle zitronenpresse  
Manual reamer · Espremedor manual

Ref	€	Ø (cm)	h (cm)	U.Venta
63912	12,70	4,5	16	1



**Exprimidor limón**  
Presse-citron · Zitruspresse  
Lemon squeezer · Espremedor de limão

Ref	€	U.Venta
62946	11,70	1

# ALIMENTOS

## Contenedor

PE ASA  
Polyethylene Acrylic BPA free

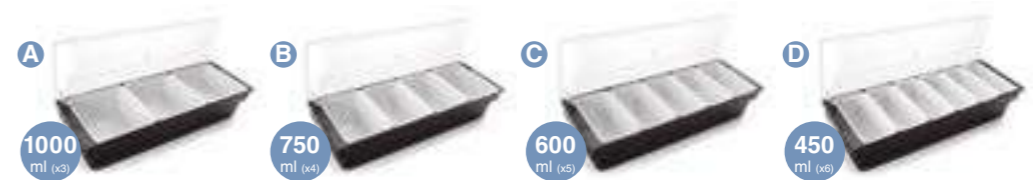

**Contenedor alimentos con tapa**

Boîte à condiments avec couvercle · Gewürzkasten mit Deckel  
Condiments holder with lid · Caixa condimentos com tampa

Ref	€	cm	Cavidades	Unidad (ml)	U.Venta
A 61133	27,70	50x16x9	3	1000	1
B 61134	27,70	50x16x9	4	750	1
C 61135	27,70	50x16x9	5	600	1
D 61136	27,70	50x16x9	6	450	1



# LAMINADORA PASTA

## Máquina



**Disfruta cocinando tu propia pasta fresca**  
Enjoy cooking your own fresh pasta

ES

- Rodillos de acero inoxidable, permiten conseguir hasta 9 grosores de pasta.
- Posibilidad del accesorio para Rabiolis.

FR

- Rouleaux en acier inoxydable, qui permettent d'obtenir jusqu'à 9 épaisseurs de pâtes.
- Possibilité d'ajouter l'accessoire pour raviolis.

EN

- Edelstahlwalzen mit 9 verschiedenen Stärken für Ihre Nudeln.
- Mit Ravioli-Aufsatz erhältlich.

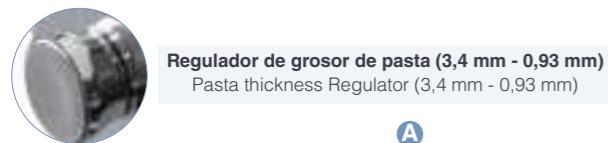

**Regulador de grosor de pasta (3,4 mm - 0,93 mm)**  
Pasta thickness Regulator (3,4 mm - 0,93 mm)



### Máquina laminadora pasta

Machine Lamineuse à pâte · Pastamaschine  
Pasta Machine Slicer · Máquina de Pasta

	Ref	€	mm	U.Venta
A	60390	45,40	145	1
B	60391	83,80	260	1



### Accesorio para ravioli

Accessoire pour raviolis · Zubehör für Ravioli  
Ravioli maker · Accesorio para ravióis

	Ref	€	Columnas	Ravioli	U.Venta
A	60497	21,80	2	45x45 mm	1
B	60498	21,80	3	30x30 mm	1

**Solo puede utilizarse en la máquina de 145 mm (Ref: 60390)**  
Only can be used in the machine of 145 mm (Ref: 60390)

Inox  
18/10



### Medidor de pasta Inox

Mesureur pour pâtes en Inox · Spaghetti-Mass Rostfrei  
St steel pasta measurer · Medidor para macarrao en Inóx

	Ref	€	cm	U.Venta
A	62942	3,30	18	1
B	62943	4,60	11x9	1

# EMBUTIDORA

## Máquina

Inox  
18/10



**Incluye boquillas**  
Includes nozzles



### Embutidora manual

Poussoir manuel · Manuelle Wurstfüller  
Manual stuffer · Máquina para encher salsichas manual

Ref	€	L	Cilindro (cm)	U.Venta
60253	278,70	3	Ø14 x 20	1
60255	319,50	5	Ø14 x 32	1
60257	368,40	7	Ø14 x 46	1
60251	424,30	10	Ø22 x 27	1

# CLIPADORA

## Máquina

Inox



200  
Grapas  
Clips

**GRAPAS · STAPLES**  
Ref: 61201  
No incluidas · Not included

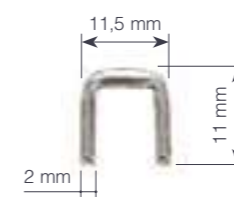

**Regulación de presión**  
Pressure adjustment

### Clipadora de alimentos

Clippeuse d'aliments · Lebensmittelzacker  
Food clipping machine · Agrafadora para alimentos

Ref	€	cm	h (cm)	U.Venta
61200	299,50	37x15	58,5	1
61201	22,10	4,6 - 6	-	1

**Grapas (4000 unid.)**  
Staples (set of 400)

- Fabricada en acero inoxidable de máxima calidad.
- Diseñada para grapar embutidos, mallas de fruta, bolsas, etc. con el mínimo esfuerzo.
- Accionamiento manual fácil y muy cómodo.
- Sistema de apoyo de zamak macizo que garantiza una estabilidad máxima.
- Capacidad de grapas: 200 unidades (ref: 61201 - no incluidas).
- Fácil de limpiar.

- Fabriqué en acier inoxydable de la plus grande qualité.
- Conçue pour agraffer de la charcuterie, des filets de fruits, des sachets, etc. avec un minimum d'efforts.
- Actionnement manuel facile et très pratique.
- Base en zamak massif qui garantit une stabilité maximale.
- Capacité d'agrafes : 200 unités (réf. : 61201 - non incluses).
- Facile à nettoyer.

- Made of top-quality stainless steel.
- Designed to staple sausages, fruit nets, bags, etc. with minimal effort.
- Easy, very comfortable manual operation.
- Solid zamak support system ensuring maximum stability.
- Staple capacity 200 units (ref: 61201 - not included).
- Easy to clean.

# CENTRIFUGADORAS

## Colección



**3 in 1**

**Centrifugadora**  
Essoreuse  
Spinner

**Escurreidor**  
Passoire  
Colander

**Ensaladera**  
Saladier  
Salad bowl

ES

- Diseñadas para escurrir ensaladas y verduras.
- Gracias a su gran velocidad de centrifugado escurren la lechuga y las verduras en segundos.
- Fácil manejo gracias a su palanca EasySpeed (61400).
- Fácil manejo gracias al pomo giratorio ergonómico (61422 / 61404 / 61405).
- Versátiles: están compuestas por 3 piezas: tapa (61422: vertedor-escurreidor integrado), rejilla y bol, perfecto para servir la ensalada en el mismo recipiente.
- Base antideslizante y 100% estable.
- Fácil limpieza: apto para el lavavajillas.
- 100% Libre de BPA.

FR

- Conçue pour essorer des salades et des légumes.
- Grâce à sa grande force centrifuge, elle essore la salade et les légumes en quelques secondes.
- Facile à manipuler grâce à son levier EasySpeed (61400).
- Manipulation facile grâce au pommeau rotatif ergonomique (61422 / 61404 / 61405).
- Versatiles : composée de 3 pièces : couvercle avec bec verseur intégré, panier grillagé et saladier, parfait pour y servir la salade.
- Base antidérapante et 100% stable.
- Nettoyage facile : apte pour le lave-vaisselle.
- 100% sans BPA.

EN

- Designed for removing excess water from salads and vegetables.
- Because of its high centrifuge speed it can strain salads and vegetables in seconds.
- Easy to use because of its EasySpeed lever (61400).
- Easy to handle because of the ergonomic rotating handle (61422 / 61404 / 61405).
- Versatile: they are made up of 3 pieces: lid (61422: integrated pourer-drainer), lid, grate, bowl, perfect for serving salad right from the container.
- Easy to clean. Dishwasher safe.
- 100% BPA free.

Para uso profesional, sencillo y eficaz  
For professional use, simple and efficient



Tapa accionamiento de giro  
Turn drive cover



PP  
polypropylene

### Centrifugadora profesional

Essoreuse à salade · Salatschleuder  
Salad spinner drier · Centrifugadora professional

Ref.	€	Ø (cm)	h (cm)	L	U.Venta
61420	202,40	32	33	12,0	1
61425	225,60	42	40	25,0	1

\*Article non vendu en France

PP  
SAN  
plastic

700  
r.p.m.

Click here



### Centrifugadora WHITE

Essoreuse · Salatschleuder  
Spinner · Centrifugadora

Ref	€	Ø (cm)	L	U.Venta
61403	29,60	26x20	5,00	1

Inox  
18/10  
ASA  
Acrylic



### Centrifugadora SPIN

Essoreuse · Salatschleuder  
Spinner · Centrifugadora

Ref	€	Ø (cm)	L	U.Venta
61404	79,00	24	4,00	1

Inox  
18/10



Tapa hermética  
Hermetic lid

Tapa centrifugadora  
Spinner lid

Escurreidor  
Colander

Bol antideslizante  
Non-slip bowl



Ideal para servir y guardar alimentos  
Ideal for serving and storing food

### Centrifugadora INOX

Essoreuse · Salatschleuder  
Spinner · Centrifugadora

Ref	€	Ø (cm)	L	U.Venta
61405	98,70	24	4,50	1

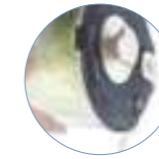
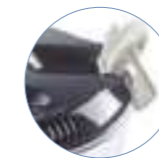

### Centrifugadora KLEIN

Essoreuse · Salatschleuder  
Spinner · Centrifugadora

Ref	€	cm	L	Ø Bol (cm)	Rejilla (cm)	U.Venta
61422	19,10	Ø20,5x19	2,6	Ø18,5x13	Ø17x10	1



Sistema de accionamiento  
Drive system



Sistema de frenado  
Brake system

### Centrifugadora MINI

Essoreuse · Salatschleuder  
Spinner · Centrifugadora

Ref	€	cm	L	Ø Bol (cm)	Rejilla (cm)	U.Venta
61400	18,40	Ø19x16	1,8	Ø18,5x11,5	Ø18x10	1

# MECHAR

## Aguja

Inox 18/10  
Dishwasher

Puntiaguda y alargada  
Pointed and elongated shape



Doble superficie dentada para una perfecta sujeción  
Double-toothed surface for optimal grip

Aguja de mechar  
Aiguille à larder · Spicknadel  
Stuffing needle · Agulha de mechar

Ref	€	L (cm)	U.Venta
61362	4,80	19	6

**Carnes y pescados más jugosos**  
Meats and fish juicier

- Su forma puntiaguda y alargada, permite abrir orificios fácilmente en la carne o pescado e insertar tiras de beicon, verduras, frutas, quesos o especias.
- Sistema de amarre con doble superficie dentada para una perfecta sujeción.
- Consigue carnes más sabrosas y pescados más jugosos.
- Apta para lavavajillas.

· Sa forme pointue et allongée permet d'ouvrir facilement des orifices dans la viande ou le poisson et d'y insérer du bacon, des légumes, des fruits, du fromage ou des épices.

· Système d'adhérence avec double surface dentée pour une meilleure fixation.

· Obtenez des viandes plus savoureuses et des poissons plus juteux.

· Apte pour le lave-vaisselle.

· Its pointed and elongated shape allows easy opening of holes in meat or fish and inserting strips of bacon, vegetables, fruits, cheeses or spices.

· Fastening system with double-toothed surface for optimal grip.

· Get tastier meats and juicier fish.

· Dishwasher safe.

# COCINA

## Jeringa & pipetas

ASA  
Acrylic Dishwasher BPA free

ES

- Inyecta salsas o especias.
- Extrae la salsa para reducirla en la sartén.



Jeringa para cocina  
Seringue pour cuisine · Spritze Küche  
Kitchen syringe · Seringa para cozinha

Ref	€	ml	Unidades	U.Venta
61418	6,00	30	ml-oz-tsp-Tbsp	6

FR

- Injecter des sauces ou des épices.
- Extraire du plat afin de les réduire dans une poêle à feu vif.



EN

- Syringe to inject sauces or spices.
- Extract them to separately reduce them in a frying pan.



Pipeta para salsa  
Poire à jus · Sossenspritze  
Sauce syringe · Pipeta para molho

	Ref	€	L (cm)	ml	U.Venta
A	61408	17,60	30	40	1
B	61416	12,90	30	40	1

# BOTELLAS BIBERÓN

## Colección

PE PELD  
Polyethylene Polyethylene BPA free



ES

- Ideales para salsas, cremas, aceites, aliños, vinagretas y todo tipo de condimentos líquidos.
- Dibuja, adorna y personaliza con estilo tus platos.

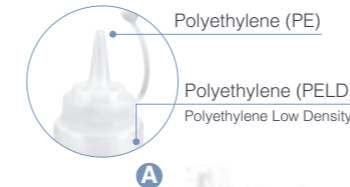

FR

- Idéal pour les sauces, les crèmes, les huiles, les assaisonnements, les vinaigrettes et tout type de condiments liquides.
- Il dessine, décore et personnalise les plats.

EN

- Ideal for sauces, creams, oils, dressings, vinaigrettes and all kinds of liquid condiments.
- Draw, decorate and personalize your dishes with style.



Botella biberón  
Bouteille biberon · Dosierflasche  
Squeeze bottle · Garrafa

Ref	€	Ø (cm)	L	U.Venta
61974	4,00	7x20	0,47	6
61977	4,30	7x26	0,71	6



B

Ideal para ketchup  
Ideal for ketchup



C

Ideal para mostaza  
Ideal for mustard

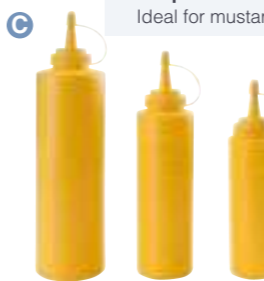

Botella biberón  
Bouteille biberon · Dosierflasche  
Squeeze bottle · Garrafa

	Ref	€	Ø (cm)	L	U.Venta
	61912	1,50	4x10	0,12	12
	61925	1,60	5x19	0,25	12
A	61940	1,70	5,5x21,5	0,40	12
	61970	1,90	7x26	0,70	12
	61925R	1,60	5x19	0,25	12
B	61940R	1,70	5,5x21,5	0,40	12
	61970R	2,00	7x26	0,70	12
	61925A	1,60	5x19	0,25	12
C	61940A	1,70	5,5x21,5	0,40	12
	61970A	2,00	7x26	0,70	12

Botella biberón PUSH  
Bouteille biberon · Dosierflasche  
Squeeze bottle · Garrafa

Ref	€	Ø (cm)	L	U.Venta
61978	4,50	6x20	0,50	1
61979	4,60	7x20	0,60	1
61980	4,80	7x26	0,70	1



Biberón decoración  
Biberon à decorer · Dekorierflasche  
Decorating pen · Garrafa decoração

Ref	€	Ø (cm)	L	U.Venta
64457	9,50	5,5x16	0,14	1





# DOSIFICADORES

## Colección

Inox  
18/10  
Dishwasher



Salado · Salty



Dulce · Sweet

ES

- Ideal para rellenar o decorar platos con salsas y cremas calientes y frías.
- Sistema de palanca para un caudal ajustable; práctico y preciso.
- Sistema antigoteo y antisalpicaduras.
- Mango con diseño ergonómico que permite el manejo con una sola mano.
- Fácil desmontaje para una sencilla limpieza. Apto para el lavavajillas.

FR

- Idéal pour remplir ou décorer des assiettes avec des sauces chaudes et froides.
- Système de piston pour un débit ajustable ; pratique et précis.
- Système anti-goutte et anti-éclaboussures.
- Manche ergonomique qui permet de le manipuler d'une seule main.
- Facile à démonter pour un nettoyage aisé, et apte pour le lave-vaisselle.

EN

- Perfect for filling or decorating dishes with hot or cold sauces and cream.
- Its lever system for controlling the flow is practical and precise.
- Anti-drip and anti-splash system.
- The ergonomic handle means it can be used with just one hand.
- It's easy to disassemble for easy cleaning and it's dishwasher safe.



Marcas de medición  
(ml - cup)  
Measuring marks  
(ml - cup)

**Dosificador**  
Entonnoir à decor · Dosierer  
Portionner · Dosificador

Ref	€	cm	h (cm)	L	U.Venta
67026	11,80	16x11	18	1,0	1



Incluye soporte y un  
platinillo antigoteo  
Includes support  
and a drip dish

**Dosificador INOX**  
Entonnoir à decor · Dosierer  
Portionner · Dosificador

Ref	€	Ø (cm)	h (cm)	L	U.Venta
67150	61,60	19	27	2,0	1
R67150B	19,90	4/6/8			1

Set 3 boquillas  
Set 3 nozzles



Salado · Salty



Dulce · Sweet

Sistema de gatillo para un caudal ajustable  
Trigger system for an adjustable flow



3  
Boquillas  
Nozzles

**Dosificador RATION**  
Entonnoir à decor · Dosierer  
Portionner · Dosificador

Ref.	€	L	U.Venta
67000	88,60	2,00	1



**Cono**  
Cône · Trichter  
Cone · Cone

Ref.	€	L	U.Venta
R67000	39,30	2,00	1

Diseño premiado en certámenes internacionales  
Award-winning design in international competitions



**Soporte mango**  
Support · Stütze  
Support · Suporte cabo

Ref.	€	U.Venta
R67001	35,40	1



**Base negra**  
Base noire · Ständer, schwarz  
Black base · Base negra

Ref.	€	U.Venta
R67002	13,90	1



**Boquillas**  
Douille · Düse  
Nozzle · Boquilhas

	Ref.	€	Ø (mm)	U.Venta
A	R67003	1,60	1	1
B	R67004	1,80	4	1
C	R67005	1,80	6	1
D	R67006	1,80	8	1

# SIFONES

## Colección

AL  
Aluminium



**APTO SOLAMENTE PARA MEZCLAS FRIAS Y TEMPLADAS (<40°C)**  
À UTILISER UNIQUEMENT POUR LES MÉLANGES FROIDS ET TREMPÉS (<40°C)  
ONLY SUITABLE FOR COLD AND TEMPERED MIXTURES (<40°C)

**EXCLUSIVAMENTE PARA USO ALIMENTICIO**  
EXCLUSIVELY FOR FOOD USE



### Cargas sifón N2O

Cartouches N<sub>2</sub>O pour siphon · N<sub>2</sub>O Kapsel für Sahnebereiter  
N<sub>2</sub>O cream charger · Botijas de sifão N<sub>2</sub>O

Ref	€	Botellas	g	U.Venta
68402	8,30	10	8	1
68403	19,40	24	8	1



**New**

### Sifón EPICURE

Siphon à crème · Sahnebereiter  
Cream whipper · Sifão creme



Ref	€	Ø (cm)	L	U.Venta
68300	104,70	9,0	0,50	1
68301	118,90	9,0	1,00	1

**Temperatura de uso** · Use temperature  
min = +5°C / max = +70°C

- Cuerpo y cabezal fabricado en acero inoxidable 18/10 de gran calidad.
- Marcaje de llenado grabado en el exterior del cuerpo.
- Versátil: Diseñado para espumas frías y espumas calientes.
- Incluye 3 boquillas de acero inoxidable con formas decorativas.
- Funciona con cargas de gas (N<sub>2</sub>O).
- Cepillo limpiador para facilitar la limpieza. Apto para el lavavajillas.

- Corps et tête fabriqués en acier inoxydable 18/10 de grande qualité.
- Marquage de remplissage gravé à l'extérieur du corps.
- Versatile : conçu pour des préparations froides et chaudes.
- Inclut 3 douilles en acier inoxydable avec des formes décoratives.
- Fonctionne avec des cartouches de gaz (N<sub>2</sub>O).
- Brosse pour faciliter le nettoyage. Compatible avec le lave-vaisselle.

- Top-quality 18/10 stainless steel body and head.
- Embossed filling marks on the outside.
- Versatile: designed for whipping up hot or cold foams.
- Includes 3 stainless steel nozzles with decorative shapes.
- Charged with gas cartridges (N<sub>2</sub>O).
- Cleaning brush for easy cleaning. Dishwasher safe.



### Sifón MIX

Siphon à crème · Sahnebereiter  
Cream whipper · Sifão creme

Ref	€	Ø (cm)	L	U.Venta
68404	100,00	7,8x25	0,50	1
68405	114,90	9,3x32,5	1,00	1

**Temperatura de uso** · Use temperature  
min = +5°C / max = +40°C



### Sifón WHITE

Siphon à crème · Sahnebereiter  
Cream whipper · Sifão creme

Ref	€	Ø (cm)	L	U.Venta
68502	40,60	9x27	0,25	1
68500	48,10	9x31	0,50	1
68501	53,60	11x36	1,00	1

**Temperatura de uso** · Use temperature  
min = +5°C / max = +40°C



### Sifón BLACK

Siphon à crème · Sahnebereiter  
Cream whipper · Sifão creme

Ref	€	Ø (cm)	L	U.Venta
68604	50,70	7,8x27,3	0,50	1
68605	55,90	9,3x32,5	1,00	1

**Temperatura de uso** · Use temperature  
min = +5°C / max = +40°C

# AHUMADORES

## Colección

AL  
Aluminium



69221 - 69321

Incluyen bolsa de serrín (100 g)  
Wood Chips bag included (100 g)

Olivo · Olive

ES

- Técnica popular de la cocina creativa; otorga a los platos aromas especiales y personalizados.
- Perfecto para ahumar todo tipo de alimentos (carnes, pescados, quesos...).
- La construcción y su diseño facilitan la limpieza y el mantenimiento.
- Ideal para presentar y terminar platos delante del cliente.
- Incluye un set de filtros de recambio.
- Fácil de transportar gracias a su forma y tamaño.
- Pilas no incluidas.
- Compatible con nuestras campanas de ahumado y la tapa

FR

- Technique populaire de la cuisine créative; qui confère aux plats des arômes spéciaux et personnalisés.
- Parfait pour fumer tout type d'aliments (viandes, poissons, fromages...).
- La fabrication et la conception de chacune de ses parties facilite son nettoyage et son entretien.
- Idéal pour présenter et apporter la touche finale à des plats devant le client.
- Inclut un set de filtres de rechange.
- Facile à transporter grâce à sa forme et sa taille.
- Piles non incluses.
- Compatible avec nos cloches de fumage et à couvercle

EN

- A popular creative cooking technique which gives dishes special and personalised aromas.
- Perfect for smoking all kinds of foods (meat, fish, cheeses...).
- The way is designed and constructed makes it easy to clean and maintain.
- Ideal for presenting and finishing dishes in front of the customer.
- Includes a set of replacement filters.
- Easy to transport thanks to its shape and size.
- Batteries not included.
- Compatible with our smoking cloches and the lid.



### Ahumador de alimentos

Fumoir pour aliments · Apparat zum Räuchern von Lebensmitteln  
Food smoker · Defumador de alimentos

	Ref	€	U.Venta
A	69221	46,30	1
B	69321	62,10	1

- Permite ahumar dos platos a la vez, ahorrando tiempo.
- Incluye 2 mangueras de goma de 40 cm, 2 boquillas y un conector de conexión de mangueras.
- Il permet de fumer deux plats à la fois, économisant ainsi du temps.
- Il comprend deux tuyaux en caoutchouc de 40 cm, deux embouts et un raccord de tuyaux.
- Two dishes can be smoked at once to save time.
- Two 40 cm rubber hoses, two nozzles and a hose connector included.

Mangueras de goma flexible  
Flexible rubber hoses



Goma  
Rubber



### Manguera doble para ahumador

Double tuyau pour fumoir · Doppelschlauch für Räucherapparat  
Double hoses for smoker · Mangueira dupla para defumador

	Ref	€	U.Venta
	69521	8,50	1

**NUNCA ponga los sifones al baño maría, puede producirse una explosión con graves consecuencias.**  
**NE JAMAIS** mettre les siphons au bain marie car une explosion pourrait avoir lieu et provoquer de graves conséquences.  
**NEVER** put siphons in a water bath, as this may cause an explosion with serious consequences.

# CAMPANAS/TAPA AHUMAR

## Colección

Vidrio Si  
Glass Silicone Dishwasher

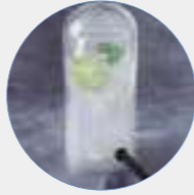
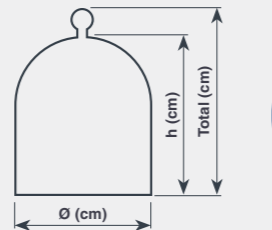
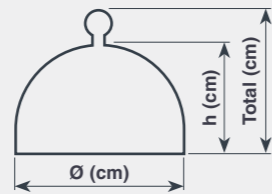

- Fabricada en vidrio borosilicato de gran calidad, es resistente a golpes, altas y bajas temperaturas.
- Permite la entrada de humo, vapor y aromas para ahumar o aromatizar alimentos/cócteles sin tener que levantar la tapa.
- Cuenta con una válvula de inyección con autocierre de silicona (max. 200° C).
- Aptas para microondas, horno y congelador.
- Complemento ideal para los ahumadores de alimentos Magic (ref. 69221) e Instant (ref. 69321).

- Fabriquées en verre borosilicate de grande qualité, elles sont résistantes aux chocs ainsi qu'aux hautes et basses températures.
- Permettent l'entrée de fumée, de vapeur et d'arômes pour fumer ou aromatiser les aliments/cocktails sans avoir à soulever le couvercle.
- Disposent d'une valve à injection avec fermeture automatique en silicone (max. 200°C).
- Aptes pour micro-ondes, four et congélateur.
- Complément idéal pour les fumoirs d'aliments Magic (réf. 69221) et Instant (réf. 69321).

- Made of high quality borosilicate glass, the hood withstands shocks, high and low temperatures.
- Allows smoke, steam and aromas in, to smoke or flavour food/cocktails without having to lift the lid.
- It has a self-closing silicone injection valve (max. 200° C).
- Microwave, oven and freezer safe.
- Ideal complement for Magic (ref. 69221) and Instant (ref. 69321) food smokers.

**Campana ahumador**  
Cloche à fumer · Räucherglocke  
Smoker Hood · Campânula defumadora

	Ref	€	Ø (cm)	h (cm)	Total (cm)	U.Venta
A	61813	13,40	12,5	7,5	11,0	1
B	61815	22,00	16,0	12,0	15,0	1
C	61816	24,30	20,0	12,0	15,0	1
D	61817	41,50	25,0	14,0	17,0	1
E	61811	28,10	18,5	22,0	25,0	1
F	61812	33,50	12,5	26,5	30,0	1

Para cocteles  
For cocktails



**Tapa para ahumar**  
Chapeau de fumée · Rauchdeckel  
Smoke cap · Tampa de fumaça

Ref	€	Ø (cm)	U.Venta
69554	4,10	12	1

ASA Si  
Acrylic Silicone

- Tapa en forma de CD para crear un efecto hermético al momento de ahumar.
- Válido para todo tipo de envases, vasos, cocteleras, tarros, etc.
- Ideal para ahumar cócteles, destilados, comidas, quesos, etc.
- Válvula de inyección con autocierre de silicona (200°C).

- Couvercle en forme de CD pour créer un effet hermétique lors du fumage.
- Apte pour tout type de contenants, verres, shakers, pots, etc.
- Idéal pour fumer des cocktails, des alcools distillés, des plats, des fromages, etc.
- Valve à injection avec fermeture automatique en silicone (200°C).

- Lid in the shape of a CD for creating a hermetic effect while smoking meats.
- Can be used with all kinds of container, glasses, cocktail glasses, jars, etc.
- Perfect for smoking cocktails, liquors, food, cheese, etc.
- Injection valve with silicone self seal (200°C).

# SERRÍN AHUMAR

## Colección



100 g

600 g

500 g

500 g

**Serrín de madera**  
Scire de bois · Räuchermehl  
Wood chips · Serrín de madeira

	Ref	€	g	U.Venta	
	69550	7,00	100	1	Olivo · Olive
	69551	7,00	100	1	Naranja · Orange
	69552	7,00	100	1	Limonero · Lemon
	69553	7,00	100	1	Almendro · Almond
	69559	7,00	100	1	Whisky
	69560	7,00	100	1	Cognac
	69555	9,50	600	1	Olivo · Olive
	69556	9,50	600	1	Naranja · Orange
	69557	9,50	600	1	Limonero · Lemon
A	69558	9,50	600	1	Almendro · Almond
	69567	9,00	500	1	Whisky
B	69568	9,00	500	1	Cognac

## Natural 100% Quality

La mejor elección para ahumar  
todo tipo de alimentos  
The best choice to smoke all  
kinds of food

- OLIVO: aporta a los alimentos un sabor suave y aromático.
- NARANJO: aporta a los alimentos un sabor dulce, afrutado y el frescor de los cítricos.
- LIMONERO: aporta a los alimentos un toque cítrico y dulce muy suave.
- ALMENDRO: aporta a los alimentos un aroma suave, dulce y floral de la almendra.
- WHISKY: aporta a los alimentos un aroma de barril de roble empleado para el reposo del Whisky
- COGNAC: aporta a los alimentos un aroma de barril de roble empleado para el reposo del Cognac.
- Producen un humo denso y de alta calidad.
- Cumplen todas las normativas y reglamentaciones existentes para el empleo con alimentos.

- OLIVE: apporte aux aliments un goût doux, fruité et la fraîcheur des agrumes.
- ORANGE: apporte aux aliments un arôme délicat, doux et floral d'amande.
- CITRONNIER: apporte aux aliments une touche d'agrumes douce et très délicate.
- AMANDIER: apporte aux aliments un arôme délicat, doux et floral d'amande.
- WHISKY: apporte aux aliments un arôme de fut de chêne utilisée pour le vieillissement du whisky.
- COGNAC: apporte aux aliments un arôme de fut de chêne utilisée pour le vieillissement du cognac.
- Produit une fumée dense et de grande qualité.
- Respecte toutes les normes et réglementations existantes pour un usage alimentaire.

- OLIVE: provides food a smooth and aromatic flavour.
- ORANGE: provides food a sweet, fruity taste and citrusy freshness.
- LEMON: provides food a very soft sweet citrusy touch.
- ALMOND: provides food with a soft, sweet, floral aroma of almonds.
- WHISKY: aromatic sawdust from the oak barrel used for ageing the whiskey.
- COGNAC: aromatic sawdust from the oak barrel used for ageing the cognac.
- Produces dense, high-quality smoke.
- Meets all existing regulations and standards for use with food.

# PROFESIONALES

## Básculas



**Cabezal orientable y abatible**  
Retractable, swivelling head

**Cuerpo aluminio fundido**  
Cast aluminium case

**Plataforma inoxidable 53x44cm**  
St. Steel platform, 53x44 cm

### Báscula industrial con base

Balance industrielle avec base · Industrieller Küchenwaage mit Sockel  
Industrial scale with base · Balança industrial com base

Ref	€	U.Venta
61700	1146,70	1

**Plataforma inoxidable 30x24 cm**  
**Plataforma extraíble**  
**Doble display (Delante / Detrás)**  
**Teclado intuitivo y de fácil uso**  
**Patas de apoyo regulables**

St. Steel platform, 30x24 cm  
Removable platform  
Double display (Front / Back)  
Intelligent and easy-to-use keyboard  
Adjustable support feet



### Báscula profesional electrónica

Balance électronique professionnelle · Elektronische Profi-Waagen  
Electronic professional scale · Balança eletrônica profissional

Ref	€	Tara
61716	472,20	15kg/5g
61730	508,10	30kg/10g

- **Batería interna recargable (autonomía de 15 días).**
- **Visor de nivel, planitud.**
- **Avisador acústico de sobrecarga.**
- **Teclado intuitivo y de fácil uso. Funciones de calculadora.**
- **Acumulación de importes.**
- **Unidades de medida (Kg · oz · Libras). Función de tara.**
- **Libro de instrucciones en 7 idiomas.**

- Batterie interne rechargeable (autonomie 15 jours).
- Indicateur de niveau, de planité.
- Avertisseur acoustique de surcharge.
- Clavier intuitif d'utilisation facile. Fonctions de calculatrice.
- Accumulation de sommes
- Unités de mesure: (Kg · Oz · Livres). Fonction de tare
- Mode d'emploi en 7 langues

- Rechargeable internal battery (last 15 days).
- Level and fatness indicator .
- Overload alarm.
- Intelligent and easy-to-use keyboard. Calculator funtions. Total counter.
- Measurement units: (Kg · Oz · pounds). Tare function
- Instructions book in 7 languages.

#### Características - Characteristics:

**Referencia** · Reference: 61700  
**Tensión** · Voltage: 220-240 V; 50-60 Hz  
**Tara** · Tare: 150 Kg (20 g)  
**Dimensiones** · Sizes: 49x75x90 cm  
**Peso** · Weight: 45 kg

**CERTIF.: 89/336/ECC, 91/263/EEC, 92/31/ECC, 93/68/EEC en 50 082 - 1:1992**

- **Batería interna recargable (autonomía 15 días).**
- **Visor de nivel, planitud.**
- **Avisador acústico de sobrecarga.**
- **Funciones cambio.**
- **Seis memorias programables.**
- **Unidades de medida (Kgs., Oz., Libras). Función de tara.**
- **Libro de instrucciones en 7 idiomas.**

- Batterie interne rechargeable (Autonomie 15 jours).
- Indicateur de niveau, de planité.
- Avertisseur acoustique de surcharge.
- Fonctions changement.
- Six mémoire programmable.
- Unités de mesure: (Kgs., Oz, Livres). Fonction de tare.
- Mode d'emploi en 7 langues.

- Rechargeable internal battery (Last 15 days).
- Level and fatness indicator.
- Overload alarm.
- Change funtions.
- Six programmable memories.
- Measurement units: (Kgrs, Oz, pounds). Tare function.
- Instructions book in 7 languages.

#### Características - Characteristics:

**Referencia** · Reference: 61716  
**Tensión** · Voltage: 220-240 V; 50-60 Hz  
**Potencia** · Power: 0,2 W (máx)  
**Tara** · Tare: 15 Kg (5 g)  
**IP** · IP: IPX 54  
**Dimensiones** · Sizes: 30x32x12 cm  
**Peso** · Weight: 4,60 kg

#### Características - Characteristics:

**Referencia** · Reference: 61730  
**Tensión** · Voltage: 220-240 V; 50-60 Hz  
**Potencia** · Power: 0,2 W (máx)  
**Tara** · Tare: 30 Kg (10 g)  
**IP** · IP: IPX 54  
**Dimensiones** · Sizes: 30x32x12 cm  
**Peso** · Weight: 4,60 kg

**CERTIF.: OIML R76 Clase III, 60/384/ECC**

Básculas - Termómetros  
Scales - Termometers

# ELECTRÓNICAS

## Básculas de cocina

Inox 18/10 



ES

- Básculas perfectas para cualquier cocina.
- Función tara.
- Reseteo automático a cero.
- Pantalla LCD, fácil lectura de los resultados.
- Función de apagado automático, ahorrar energía.
- Indicador de batería baja y sobrecarga.

FR

- Balances parfaites pour toutes les cuisines.
- Fonction tare.
- Mise à zéro automatique.
- Écran LCD, lecture facile des résultats.
- Fonction d'arrêt automatique pour permettre des économies d'énergie.
- Indicateur de batterie faible et de surcharge.

EN

- This scales is perfect for any kitchen.
- Tare function.
- Automatic reset to zero.
- LCD screen with easy to read results.
- Automatic shut-off to save energy.
- It has a low battery and overload indicator.

15 Kg



4 sensores de alta precisión  
Four high precision sensors

### Báscula de cocina EBEN

Balance de cuisine · Küchenwaage  
Kitchen scale · Balança de cozinha

Ref	€	Kg	División (g)	cm	Unidades	U.Venta
61717	54,70	15	1	31x25,6x2,5	g/Kg/oz/lb/oz	1

Cristal  
Glass



### Báscula de cocina SLIM

Balance de cuisine · Küchenwaage  
Kitchen scale · Balança de cozinha

Ref	€	Kg	División (g)	cm	Unidades	U.Venta
61708	27,30	5	1	27x18x4	g/oz/ml/cups	1

Bambú  
Bamboo



### Báscula de cocina BAMBOO

Balance de cuisine · Küchenwaage  
Kitchen scale · Balança de cozinha

Ref	€	Kg	División (g)	cm	Unidades	U.Venta
61712	23,80	5	1	21,8x18,8x2,1	g/ml/lb/oz/fl-oz	1



### Báscula de cocina ROUND

Balance de cuisine · Küchenwaage  
Kitchen scale · Balança de cozinha

Ref	€	Kg	División (g)	cm	U.Venta
61703	60,20	5	1	15,5x12	1



### Báscula de cocina CRISTAL

Balance de cuisine · Küchenwaage  
Kitchen scale · Balança de cozinha

Ref	€	Kg	División (g)	U.Venta
61725	22,60	5	1	1

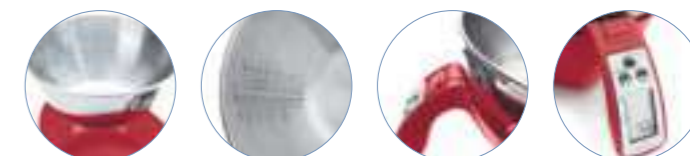

### Báscula digital con bol extraíble

Balance numérique avec bol amovible · Digitalwaage mit abnehmbarer Schale  
Scale digital with removable bowl · Balança digital com bacia removível

Ref	€	Ø (cm)	L	Kg	División (g)	U.Venta
61707	36,90	21 (bol)	1,50	5	1	1

# ECO

## Básculas de cocina

- Tecnología sin pilas ni baterías: se carga mediante el giro de la ruleta.
- Sistema EcoMove: convierte la energía cinética (energía en movimiento) en energía eléctrica.
- 61720: Fabricado en cristal templado de 4 mm de grosor y acabado con efecto mármol. Extraplano. Medición de alta precisión. Capacidad máx. de 5 kg con una división de 1 g.
- 61719: Recipiente desmontable que facilita la mezcla de los ingredientes. Libre de BPA.
- Pantalla LCD retroiluminada: facilita la lectura de los datos.
- Muestra los resultados en g (gramos), oz (onzas), lb:oz (onzas líquidas), ml-agua (mililitros- agua) y ml-leche (mililitros-leche).
- Función tara. Apagado y reseteo automático.
- Cuatro pies anti-deslizantes que proporcionan máxima estabilidad y seguridad.

- Battery Free Technology: Charged by turning the wheel.
- EcoMove System: converts kinetic energy (movement) into electric energy.
- 61720: Made of 4 mm thick tempered glass with a marble effect finish. Extra-flat design. High precision measurement. Maximum capacity 5kg with 1g divisions.
- 61719: The removable container makes it easy to mix ingredients. BPA free.
- Backlit LCD Screen: makes reading information easy.
- Shows results in g (grams), oz (ounces), lb:oz (fluid ounces), ml-water (millilitres - water) and ml-milk (millilitres-milk).
- Tare function. Automatic shutdown and reset.
- The four non-slip feet provide maximum stability and safety.

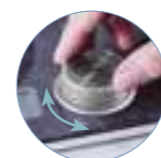

Sistema EcoMove  
EcoMove system



### Báscula de cocina ECO MARMOL

Balance de cuisine · Küchenwaage  
Kitchen scale · Balança de cozinha

Ref	€	Kg	División (g)	cm	U.Venta
61720	34,50	5	1	19x23,5x3,5	1



Sistema EcoMove  
EcoMove System



### Báscula de cocina ECO

Balance de cuisine · Küchenwaage  
Kitchen scale · Balança de cozinha

Ref	€	kg	Division (g)	Units	U.Venta
61719	29,80	5	1	g / oz / lb:oz ml-agua/water / ml-leche/milk	1

# MECÁNICAS

## Básculas de cocina

Inox  
18/10



### Báscula de cocina

Balance de cuisine · Küchenwaage  
Kitchen scale · Balança de cozinha

	Ref	€	Kg	División (g)	Ø Bol (cm)	U.Venta
A	61705	55,20	5	20	20,5x4	1
	61710	56,90	10	50	20,5x4	1
B	61715	85,80	15	50	-	1



### Báscula de cocina WHITE

Balance de cuisine · Küchenwaage  
Kitchen scale · Balança de cozinha

	Ref	€	Kg	División (g)	Bol (L)	U.Venta
A	61714	37,20	5	20	2,0	1
B	61702	20,10	1	2	2,0	1

# PRECISIÓN

## Básculas de cocina

- Diseñadas para un pesaje muy preciso.
- Elabore recetas vanguardistas. La precisión de estas básculas ayudará a pesar los ingredientes más exclusivos.
- Compacta, ahorra espacio de almacenamiento.
- Plataforma de pesaje de acero inoxidable de máxima calidad (61709-61711).

- Designed for very precise weighing. Create nuanced recipes.
- The precision of this scale will help you weigh the most exclusive ingredients.
- Compact, to help save storage space.
- Weighing platform made of high quality stainless steel (61709-61711).

Muestra los resultados en gramos (g) y onzas (oz)  
Shows the results in grams (g) and ounces (oz)



### Cuchara medidora digital

Cuillère avec Balance Digital · Digitale Löffelwaage  
Digital spoon scale · Colher de pesar Digital

Ref	€	g	División (g)	L (cm)	U.Venta
62519	39,50	300	0,10	28	1

Inox  
CE  
BPA free

Muestra los resultados en gramos (g), onzas (oz), onzas troy (ozt) y quilate (ct)  
Shows the results in grams (g), ounces (oz), troy ounces (ozt) and carat (ct).



11x13x2 cm    10,5x10,5x0,5 cm  
Incluye 2 bandejas para el pesaje (ABS plastic)  
Includes 2 weighing trays

### Báscula de precisión

Balance de précision · Präzisionswaage  
Precision scale · Balança de precisão

	Ref	€	Kg	División (g)	cm	U.Venta
A	61709	17,10	0,65	0,1	13x8x2	1
B	61711	17,90	2,00	0,1	12,7x10,6x1,7	1

# GANCHO

## Básculas

Inox  
18/10  
CE



### Báscula con gancho

Balance électronique avec crochet · Elektronischeküchenwaage mit Haken  
Electronic scale w/hook · Balança de gancho

	Ref	€	Kg	División (g)	U.Venta
A	61721	22,70	10	5	1
B	61722	72,60	0 - 50	20	1
			50 - 150	100	

# BAÑO

## Básculas

Inox  
18/10  
CE



Sistema EcoMove  
EcoMove System



### Báscula de baño ECO

Pèse personne · Personenwaage  
Bathroom scale · Escala de banheiro

Ref	€	Kg	División (g)	cm	U.Venta
61742	38,50	180	100	31x29x5	1



### Báscula de baño

Pèse personne · Personenwaage  
Bathroom scale · Escala de banheiro

Ref	€	Kg	División (Kg)	cm	Unidades	U.Venta
61740	33,10	180 (397lb)	0,1 (0,22lb)	31x31x4	Kg / lb	1

- Tecnología sin pilas ni baterías: se carga pulsando el botón central.
- Sistema EcoMove: convierte la energía cinética (energía en movimiento) en energía eléctrica.
- Fabricado en cristal templado de 5 mm de grosor y acabado con efecto mármol.
- Medición de alta precisión: accionado por 4 sensores de peso de máxima precisión. Amplio rango de medición, desde los 8 kg hasta los 180 kg (máx.) con una división de 100 g.
- Pantalla LCD retroiluminada: facilita la lectura de los datos.
- Muestra los resultados en Kg (kilogramos) y lb (libras).
- Apagado y reseteo automático.
- Cuatro pies antideslizantes que proporcionan máxima estabilidad y seguridad.

- Battery Free Technology: Charged by pushing the button in the middle.
- EcoMove System: converts kinetic energy (movement) into electric energy.
- Made of 5mm thick tempered glass with a marble effect finish.
- High Precision Measurement: activated by 4 maximum precision weight sensors. Wide measurement range from 8kg up to 180kg (max) with 100g divisions.
- Backlit LCD Screen: makes reading information easy
- Shows results in Kg (kilograms) and lb (pounds)
- Automatic shutdown and reset
- The four non-slip feet provide maximum stability and safety.

# COCINA

## Termómetros & relojes



### Termómetro analógico de aceite

Thermometre analogique de huile · Analog Thermometer für Öl  
Oil analogic thermometer · Termómetro analógico óleo

Ref	€	cm	Temp.	U.Venta
62495	12,40	5x30,5	40°C (104°F) 200°C (392°F)	1



La lente debería mantenerse limpia en todo momento  
The lens should be kept clean at all times

### Termómetro DUAL

Thermomètre · Thermometer  
Thermometer · Termómetro

Ref	€	Temp.	Sonda	U.Venta
62458	103,70	-40°C (-40°F)/230°C (302°F)	-33°C (-27°F)/220°C (428°F)	1



### Termómetro sonda

Thermometre sonde · Thermometer/Sonde  
Thermometer probe · Termómetro sonda

Ref	€	Temp.	L (cm)	U.Venta
62500	16,00	-50°C (-64°F)/300°C (572°F)	25	1
62528	17,20	-50°C (-64°F)/300°C (572°F)	25	1



Horno · Oven    Refrigerador · Refrigerator    Carne · Meast

### Termómetro

Thermomètre · Thermometer  
Thermometer · Termómetro

Ref	€	Temp.	U.Venta
A 62454	9,70	50°C (122°F)/300°C (572°F)	1
B 62450	7,60	-30°C (-22°F)/30°C (86°F)	1
C 62452	8,20	-54°C (129°F)/88°C (190°F)	1



### Termómetro digital

Thermomètre numérique · Digital Thermometer  
Digital thermometer · Termómetro Digital

Ref	€	L (cm)	Temp.	U.Venta
A 62487	29,80	23	0°C (-32°F)/300°C (572°F)	1
B 62453	20,60	15	-40°C (-40°F)/150°C (302°F)	1



### Termómetro electrónico

Thermomètre Electronique · Electric Thermometer  
Thermometer, Elektronisch · Termómetro Electrónico

Ref	€	Temp.	U.Venta
62459	20,70	-40°C (-40°F)/150°C (302°F)	1



### Termómetro digital horno

Thermomètre numérique pour le four · Digitaler Ofen-Thermometer  
Oven digital thermometer · Termómetro digital horno

Ref	€	cm	Temp.	U.Venta
62498	49,50	12x7,5	0°C (-32°F)/300°C (572°F)	1

La lente debería mantenerse limpia en todo momento  
The lens should be kept clean at all times

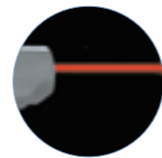

NUNCA APUNTE CON EL DISPOSITIVO LOS OJOS DE ALGUIEN  
He jamais pointer l'instrument vers les yeux de quelqu'un  
Never point the device towards anyone's eyes



### Termómetro infrarrojos LASER

Therm. mesure de surface par infra rouge · Infrarot Thermometer  
Infrared thermometer · Termómetro infravermelhos

Ref	€	Temp.	U.Venta
62457	122,80	-50°C (-58°F)/400°C (752°F)	1



Protector de plástico  
Plastic protector



### Termómetro de leche

Thermomètre à lait · Milch Thermometer  
Milk thermometer · Termómetro de leite

Ref	€	L (cm)	T°	Unidad	U.Venta
62532	11,80	26,5	-10°C/110°C	°C	1



Magnético  
Magnet

### Reloj de cocina con alarma

Minuteur de Cuisine avec Alarme · Küchen-Zeitschaltuhr mit Alarm  
Kitchen Timer Alarm · Relógio de cozinha com alarme

Ref	€	cm	U.Venta
60804	38,90	13x24,5x2,5	1



Magnético  
Magnet

### Reloj digital de cocina con avisador acústico

Minuter Électronique · Digitale Küchen-Zeitschaltuhr mit Alarm  
Digital kitchen timer w/alarm · Relógio digital de cozinha com alarme acústico

Ref	€	cm	U.Venta
60805	9,00	10,5x7	1

Doble pantalla para nevera y congelador  
Double screen for fridge and freezer



Base magnética  
Magnetic base

### Termómetro para nevera/congelador

Thermomètre de réfrigérateur/congélateur · Thermometer f/Kühlschrank/Gefrierfach  
Fridge/Freezer thermometer · Termómetro para refrigerador/congelador

Ref	€	Temp.	Temp.	U.Venta
62456	37,70	0°C (-32°F)/70°C (572°F)	0°C (-572°F)/-40°C (-32°F)	1



Clip de sujeción (cacerolas) y bola de madera para un fácil manejo  
Hanging clip (casseroles) and wooden ball for easy handling



Funda de protección incluida  
Protective cover included

### Termómetro de azúcar

Thermomètre à sucre · Zuckerthermometer  
Sugar thermometer · Termómetro de açúcar

Ref	€	L (cm)	T°	Unidades	U.Venta
62533	5,10	21,5	200°C (400°F)	°C / °F	12



Magnético  
Magnet

### Reloj de cocina magnético

Minuteur de cuisine magnetique · Magnetküchentimer  
Magnetic kitchen timer · Relógio de cozinha magnetico

Ref	€	Tiempo	cm	U.Venta
60803	10,80	60 min	9,2x3,5	1



Soporte plegable. Potente imán  
Folding stand. Powerful magnet

### Reloj de cocina con alarma

Minuteur de Cuisine avec Alarme · Küchen-Zeitschaltuhr mit Alarm  
Kitchen Timer Alarm · Relógio de cozinha com alarme

Ref	€	cm	U.Venta
60802	19,60	7x1,4x5,1	1

# 03

Mesa  
Table Top





# INOX

## Bandejs · Platos



### ES

- Para uso profesional o doméstico.
- Fabricadas en acero inoxidable de alta calidad.
- Excelente resistencia a la corrosión.
- Ideales para servir o presentar todo tipo de comidas en buffets, restaurantes o en casa.

### FR

- Pour un usage professionnel ou domestique.
- Fabriqué en acier inoxydable de grande qualité.
- Excellente résistance à la corrosion.
- Parfaits pour servir ou présenter tout type d'aliments dans des buffets, des restaurants ou à la maison.

### EN

- For professional or home use.
- Made from high-quality stainless steel.
- Extremely resistant to corrosion.
- Ideal for serving and presenting all types of food in buffets, restaurants, or even at home.



**Plegable (7 cm)**  
Collapsible (7 cm)



### Soporte para bandejas

Support pour plateaux · Tablethalter  
Tray stand · Suporte para bandejas

Ref	€	cm	h (cm)	U.Venta
61870	68,00	41,5x52	80	1

### Bandejas redondas, ovales, cuadradas, rectangulares, etc.

It can be used with round, oval, square, rectangular trays...

- Soporte fabricado en acero inoxidable de máxima calidad.
- Diseñado para apoyar bandejas de gran tamaño en servicio de sala.
- Barras tubulares y soportes cruzados para una mayor resistencia y estabilidad.
- 100% seguro: 8 arandelas ajustables y pies antideslizantes para que las bandejas no resbalen en ningún momento.
- Plegable; facilita el traslado y el almacenaje.
- Support fabriqué en acier inoxydable de la plus grande qualité.
- Conçu pour y poser des plateaux de grande taille lors du service en salle.
- Barres tubulaires et supports croisés pour une plus grande résistance et stabilité.
- 100% sûr : 8 rondelles réglables et pieds antidérapants pour que les plateaux ne glissent pas.
- Pliable ; facilite le transport et le rangement.
- Stand made of top-quality stainless steel.
- Specially designed to support large trays when serving food.
- Tubular bars and cross supports for extra strength and stability.
- 100% safe: 8 adjustable washers and non-slip feet to prevent the trays from slipping at any moment.
- Collapsible, easy to carry and store.



### Fuente oval

Plat ovale · Buffet-Tablett, oval  
Oval dish · Travessa oval

Ref	€	cm	U.Venta
61820	5,90	20x13	1
61825	8,30	25x17	1
61830	9,10	30x20	1
61835	11,30	35x23	1
61840	13,60	40x26	1
61845	15,90	45x29	1
61850	19,50	50x31	1
61871	45,20	70x45	1
61881	52,80	80x48	1

Inox  
18/10



### Fuente oval pulido satinado

Plat ovale poli-satine · Buffet-Tablett, oval  
Oval dish satin polish · Travessa oval pulido mate

Ref	€	cm	U.Venta
62820	8,60	20x13	1
62825	10,90	25x17	1
62830	13,60	30x20	1
62835	16,80	35x23	1
62840	22,10	40x26	1
62845	25,00	45x29	1
62850	30,10	50x31	1



### Fuente redonda

Plat rond 3 Bratenplatte, rund  
Round serving dish · Travessa redonda

Ref	€	Ø (cm)	U.Venta
61831	11,00	30	6
61836	13,70	35	6



### Fuente de pescado

Plat à poisson · Fischplatte  
Fish tray · Travessa peixe

Ref	€	cm	U.Venta
61860	28,10	60x27	1
61880	35,60	80x30	1



### Fuente honda oval

Plat à gratin ovale · Schale, oval  
Deep oval dish · Travessa funda oval

Ref	€	cm	h (cm)	U.Venta
61828	13,70	30x20	4,5	1
61832	16,70	35x24	4,5	1
61838	20,60	40x26	4,5	1
61843	22,20	45x29	4,5	1
61848	26,50	50x31	4,7	1



### Bandeja octogonal

Plateau octogona · Platte, achteckig  
Octogonal tray · Bandeja octogonal

Ref	€	cm	U.Venta
65031	54,70	31x24	1
65037	66,30	37x27	1
65041	116,20	41x32	1
65046	152,70	46x36	1

## New

AL  
Aluminium



### Bandeja MASTER

Plateau · Platte  
Tray · Bandeja

	Ref	€	cm	h (cm)	U.Venta
A	68465	23,10	45x33	5,0	1
B	68466	24,10	53x38	2,5	1

- Calidad premium: Fabricada en aluminio natural; 99,5% de pureza.
- Garantiza una conductividad térmica superior, con una distribución homogénea del calor permitiendo así que todas las elaboraciones se doren y se horneen de forma uniforme.
- Especialmente diseñadas para profesionales de la repostería, cocinas exigentes y de alta producción.
- Ligera, resistente e indeformable, fácil manejo.
- Limpieza: Se recomienda lavarla a mano con un jabón y una esponja no abrasivos. No apto para el lavavajillas.
- Consejos de uso: se recomienda usar tanto papel / tapete para hornear.

- Qualité premium : Fabriqué en aluminium naturel ; 99,5% de pureté.
- Garantit une conductivité thermique supérieure avec une distribution homogène de la chaleur, permettant ainsi à toutes les préparations culinaires de dorer et cuire de façon uniforme.
- Spécialement conçu pour les professionnels de la pâtisserie, les cuisines exigeantes et de grande production.
- Léger, résistant et indéformable ; facile à manipuler.
- Nettoyage : il est recommandé de le laver à la main avec du savon et une éponge non abrasifs. Ne peut pas aller au lave-vaisselle.
- Conseils d'utilisation : il est recommandé d'utiliser du papier sulfurisé ou un tapis de cuisson pour cuire les aliments.

- Premium quality: made from 99.5% pure natural aluminium.
- Guarantees excellent thermal conductivity and homogeneous heat distribution, allowing all baked goods to brown and bake evenly.
- Specially designed for professional bakers, demanding chefs and busy, high output kitchens.
- Lightweight, robust, non-deformable and easy to handle.
- Cleaning: cleaning by hand with detergent and a non-abrasive sponge is recommended. Not dishwasher safe.
- Instructions for use: baking mats and baking paper are both recommended.

garinox®



### Bandeja de marisco

Plateau a fruit de mer · Platte für Seemuschel  
Sea food tray · Bandeja de mariscos

Ref	€	Ø (cm)	U.Venta
14027	9,70	28	6
14042	21,60	42	1
14050	33,80	50	6



### Soporte para bandeja de mariscos

Support pour plateau a fruit de mer · Ständer für Seemuschelplatte,  
Stand for sea food tray · Suporte para bandeja de mariscos

Ref	€	Ø Sup. (cm)	Ø Inf. (cm)	h (cm)	U.Venta
14100	14,60	24,5	19	20	1



### Bandeja camarero

Plateau limonadier · Serviertablett, rund  
Serving tray · Bandeja de servir

Ref	€	Ø (cm)	U.Venta
61841	21,00	40	1



### Bandeja camarero pulido satinado

Plateau limonadier poli-satine · Serviertablett, rund  
Serving tray satin polish · Bandeja de servir pulido mate

Ref	€	Ø (cm)	U.Venta
62841	27,90	40	1



### Bandeja camarero

Plateau limonadier · Serviertablett  
Serving tray · Bandeja de servir

Ref	€	Ø (cm)	U.Venta
14135	10,10	32	6
14136	11,70	36	1
14145	19,80	45	1



### Plato de huevos

Plat à oeufs · Eiteller  
Egg serving dish · Prato de ovos

Ref	€	Ø (cm)	h (cm)	U.Venta
61116	5,10	16	3	6



### Bandeja con pinza para notas

Porte addition á pince · Platte mit Klemmvorrichtung  
Bill holder · Bandeja com pinça para notas

Ref	€	cm	U.Venta
A 68007	5,30	11x15,2	12
B 68017	6,20	12x21,5	12



### Bandeja cambios COIN

Coupelle ramasse monnaie · Wechselgeldablagen  
Changetray · Bandeja para trocos

Ref	€	Ø (cm)	U.Venta
68720	3,10	13	12



### Plato camping

Plate de camping · Campingplatte  
Camping dinner plate · Prato camping

Ref	€	Ø (cm)	U.Venta
A 61121	7,00	22	1
B 61122	7,40	22	6



### Posabotellas

Dessous de bouteille · Flaschenuntersetzer  
Bottle stand · Pousa-garrafas

Ref	€	Ø (cm)	U.Venta
61113	3,80	13	6



### Posavasos

Sous-verre · Glasuntersetzer  
Glass stand · Pousa-copos

Ref	€	Ø (cm)	U.Venta
61110	3,20	10,5	6

# PIZARRA

## Bandejas



ES

- Totalmente artesanales, cada bandeja es única e irrepetible.
- Ideal para la presentación de platos fríos y calientes.
- Ofrecen un aire de modernidad, elegancia y sencillez.
- Excelente conductor del frío y del calor.
- Evita los cambios bruscos de temperatura para su conservación.
- Contienen tacos antideslizantes para asegurar su estabilidad.
- NOTA: para conservarlas brillantes y con su color natural, cada ciertos usos impregnarlas con aceite de oliva virgen extra por ambas caras y cantos.

FR

- Totalemant artisanaux, chaque plateau étant unique et inimitable.
- Idéal pour la présentation de plats froids et chauds.
- Ils apportent un air de modernité, d'élégance et de simplicité.
- Excellent conducteur du froid et de la chaleur.
- Évite les changements de température brusques pour leur conservation.
- Possèdent des taquets antidérapants pour assurer leur stabilité.
- REMARQUE : pour conserver leur brillance et leur couleur naturelle, il faut les imprégner régulièrement d'huile d'olive vierge sur les deux côtés et sur les bords.

EN

- Entirely handmade, every tray is unique and unreproducible.
- Perfect for presenting hot and cold dishes.
- They have an air of modernity, elegance and simplicity.
- Excellent conductor of heat and cold.
- Avoid abrupt temperature changes to prevent damage.
- They have anti-slip feet to ensure stability.
- NOTE: after every few uses, wipe the edges and both faces thoroughly with extra virgin olive oil to preserve their brightness and natural colour.



### Bandeja redonda

Plateau rond · Serviertablett rund  
Round tray · Bandeja redonda

Ref	€	Ø (cm)	e (mm)	U.Venta
61070	3,50	20	5	6
61071	5,00	25	5	6
61072	6,90	30	5	6
61073	9,70	35	5	4
61078	9,80	40	5	4



### Bandeja cuadrada

Plateau carré · Serviertablett, viereckig  
Square tray · Bandeja quadrada

Ref	€	cm	e (mm)	U.Venta
61010	3,00	10x10	5	32
61015	4,40	15x15	5	32
61019	5,10	20x20	5	24
61044	16,00	40x40	5	8



### Bandeja rectangular

Plateau rectangulare · Serviertablett, rechteckig  
Rectangular tray · Bandeja rectangular

Ref	€	cm	e (mm)	U.Venta
61016	4,20	10x15	5	48
61021	4,90	15x20	5	24
61029	6,10	15x30	5	18
61031	7,70	20x30	5	12
61041	9,00	20x40	5	12
61051	12,70	20x50	5	8
61043	14,00	40x30	5	8
61064	28,50	60x40	5	3

# FIBREGLASS

## Bandejas

Fibra de vidrio **80°C**  
 Fibreglass max Dishwasher ECO



### ES

- Para uso profesional.
- Fabricadas en fibra de vidrio.
- Superficie antiadherente y antideslizante.
- Indeformables y muy ligeras.

### FR

- Pour un usage professionnel.
- Fabriqué en fibre de verre.
- Surface antiadhésive et antidérapante.
- Indéformable et très légères.

### EN

- For professional use.
- Made of fibreglass.
- Non-stick and non-slip surface.
- Undeformable and very light.



#### Bandeja redonda

Plateau rond · Serviertablett rund  
 Round tray · Bandeja redonda

Ref	€	Ø (cm)	U.Venta
69136	14,10	36	1
69140	20,90	40	1



#### Bandeja rectangular

Plateau rectangulare · Serviertablett, rechteckig  
 Rectangular tray · Bandeja rectangular

Ref	€	cm	U.Venta
69146	24,50	36x46	1
69152	29,50	38x52	1
69156	37,50	40x56	6
69165	53,90	45x65	6



#### Bandeja oval

Plateau ovale · Oval Serviertablett  
 Oval tray · Bandeja oval

Ref	€	cm	U.Venta
69168	64,20	56x68	6

Melamina  
 Melamine



# EARTH Colección



## ES

- Fabricadas en melamina de alta calidad. Libre de BPA.
- Una completa gama que ofrece un aspecto rústico, con piezas únicas y elegantes.
- Diseñadas para realizar las creaciones del chef.
- Ligeras, resistentes a golpes y choques térmicos.
- Higiénicas y fácilmente lavables, aptas para lavavajillas.

## FR

- Produits fabriqués en mélamine de grande qualité. Sans BPA.
- Une gamme complète qui offre un aspect rustique, avec des pièces uniques et élégantes.
- Conçus pour réaliser les créations du chef.
- Légers, résistants aux chocs et aux variations thermiques.
- Hygiéniques et faciles à laver, aptes pour le lave-vaisselle.

## EN

- Made of high quality melamine. BPA free.
- A full range with unique and elegant pieces and a rustic look.
- Designed to highlight the chef's creations.
- Lightweight and resistant to impacts and thermal shock.
- Hygienic, easy to wash and dishwasher safe.



### Fuente rectangular

Plateau rectangulaire · Serviertablet, rechteckig  
Rectangular tray · Travessa rectangular

Ref	€	cm	h (cm)	U.Venta
63830	8,20	18,6x13,5	2,7	1



### Fuente rectangular

Plateau rectangulaire · Serviertablet, rechteckig  
Rectangular tray · Travessa rectangular

Ref	€	cm	h (cm)	U.Venta
63831	10,10	21,7x13,6	3,1	1
63832	12,40	25,2x17,2	3,6	1
63834	20,80	30,8x21,6	3,5	1
63855	28,50	35x23,8	4,1	1



### Fuente rectangular

Plateau rectangulaire · Serviertablet, rechteckig  
Rectangular tray · Travessa rectangular

Ref	€	cm	h (cm)	U.Venta
63833	11,40	28,6x12,7	3,4	1



### Fuente rectangular undulada

Plateau rectang. ondulé · Serviertablet, rechteckig, gewellt  
Rectangular undulated tray · Travessa rectang. undulada

Ref	€	cm	h (cm)	U.Venta
63865	18,40	29x17,5	3,0	1



### Fuente oval

Plateau oval · Oval platte  
Oval tray · Travessa redonda

Ref	€	cm	h (cm)	U.Venta
63863	9,50	25,4x13	2,9	1



### Fuente lágrima

Plateau larme · Träne platte  
Tear tray · Travessa lágrima

Ref	€	cm	h (cm)	U.Venta
63854	16,70	28,2x21,4	4,8	1



### Fuente oval

Plateau oval · Oval platte  
Oval tray · Travessa redonda

Ref	€	cm	h (cm)	U.Venta
63852	8,40	19,7x14,1	3,7	1
63853	11,50	22,5x16,4	4,4	1
63864	18,10	28,4x19	5,1	1



### Plato redondo

Plateau rond · Rund Teller  
Round plate · Prato redondo

Ref	€	Ø (cm)	h (cm)	U.Venta
63841	6,00	15,5	2,4	1
63842	9,00	19,4	2,9	1
63843	9,70	21,5	3,2	1
63844	15,30	24,2	3,5	1
63845	17,60	25,6	3,7	1



### Plato hondo redondo

Plateau profonde ronde · Rund tiefe Platte  
Round deep plate · Prato profundo redondo

Ref	€	Ø (cm)	h (cm)	U.Venta
63839	9,00	17,7	4,4	1
63840	18,90	24	5,5	1



### Fuente cuadrada

Plateau carrée · Quadratischen platte  
Square tray · Travessa quadrado

Ref	€	cm	h (cm)	U.Venta
63846	7,50	12x12	5,0	1
63847	15,80	19x19	6,0	1
63848	24,50	24x24	6,8	1



### Bol salsa mini

Bol sauce mini · Boul sauce min  
Sauce bowl mini · Bacia molho mini

Ref	€	cm	h (cm)	ml	U.Venta
63862	2,90	7,2x7,2	3,0	30	1



### Bol

Bol · Boul  
Bowl · Bacia

Ref	€	Ø (cm)	h (cm)	ml	U.Venta
63856	3,00	8,3	3,2	60	1
63857	4,80	9,5	4,6	130	1
63858	5,10	10,6	5,2	220	1
63859	7,00	12,6	6,0	300	1
63861	6,40	12,4	4,6	300	1



### Bol oval

Bol oval · Oval bowl  
Oval bowl · Bacia oval

Ref	€	cm	h (cm)	ml	U.Venta
63849	4,50	12x10	4,1	130	1
63860	7,80	16,3x12,3	4,7	220	1
63850	15,60	20,7x16,8	8,0	660	1
63851	24,30	24,2x20,6	9,3	1150	1



### Bol cónico

Conique bol · Boul Konish  
Conical bowl · Bacia cónica

Ref	€	Ø (cm)	h (cm)	ml	U.Venta
63835	8,80	15,7	5,9	330	1
63836	10,70	18,3	6,8	560	1
63837	14,10	21,3	7,8	750	1
63838	19,90	24,2	8,8	1350	1

# SEA Colección



## ES

- Fabricadas en melamina de alta calidad. Libre de BPA.
- Una completa gama que ofrece un aspecto rústico, con piezas únicas y elegantes.
- Diseñadas para realizar las creaciones del chef.
- Ligeras, resistentes a golpes y choques térmicos.
- Higiénicas y fácilmente lavables, aptas para lavavajillas.

## FR

- Produits fabriqués en mélamine de grande qualité. Sans BPA.
- Une gamme complète qui offre un aspect rustique, avec des pièces uniques et élégantes.
- Conçus pour réaliser les créations du chef.
- Légers, résistants aux chocs et aux variations thermiques.
- Hygiéniques et faciles à laver, aptes pour le lave-vaisselle.

## EN

- Made of high quality melamine. BPA free.
- A full range with unique and elegant pieces and a rustic look.
- Designed to highlight the chef's creations.
- Lightweight and resistant to impacts and thermal shock.
- Hygienic, easy to wash and dishwasher safe.



### Fuente rectangular

Plateau rectangulaire · Serviertablet, rechteckig  
Rectangular tray · Travessa rectangular

Ref	€	cm	h (cm)	U.Venta
63941	8,20	18,6x13,5	2,7	1



### Fuente rectangular

Plateau rectangulaire · Serviertablet, rechteckig  
Rectangular tray · Travessa rectangular

Ref	€	cm	h (cm)	U.Venta
63942	10,10	21,7x13,6	3,1	1
63943	12,40	25,2x17,2	3,6	1
63945	20,80	30,8x21,6	3,5	1
63966	28,50	35x23,8	4,1	1



### Fuente rectangular

Plateau rectangulaire · Serviertablet, rechteckig  
Rectangular tray · Travessa rectangular

Ref	€	cm	h (cm)	U.Venta
63944	11,40	28,6x12,7	3,4	1



### Fuente rectangular ondulada

Plateau rectang. ondulé · Serviertablet, rechteckig, gewellt  
Rectangular undulated tray · Travessa rectang. ondulada

Ref	€	cm	h (cm)	U.Venta
63976	18,40	29x17,5	3,0	1



### Fuente oval

Plateau oval · Oval platte  
Oval tray · Travessa redonda

Ref	€	cm	h (cm)	U.Venta
63974	9,50	25,4x13	2,9	1



### Fuente lágrima

Plateau larme · Träne platte  
Tear tray · Travessa lágrima

Ref	€	cm	h (cm)	U.Venta
63965	16,70	28,2x21,4	4,8	1



### Fuente oval

Plateau oval · Oval platte  
Oval tray · Travessa redonda

Ref	€	cm	h (cm)	U.Venta
63963	8,40	19,7x14,1	3,7	1
63964	11,50	22,5x16,4	4,4	1
63975	18,10	28,4x19	5,1	1



### Plato redondo

Plateau rond · Rund Teller  
Round plate · Prato redondo

Ref	€	Ø (cm)	h (cm)	U.Venta
63952	6,00	15,5	2,4	1
63953	9,00	19,4	2,9	1
63954	9,70	21,5	3,2	1
63955	15,30	24,2	3,5	1
63956	17,60	25,6	3,7	1



### Plato hondo redondo

Plateau profonde ronde · Rund tiefe Platte  
Round deep plate · Prato profundo redondo

Ref	€	Ø (cm)	h (cm)	U.Venta
63950	9,00	17,7	4,4	1
63951	18,90	24	5,5	1



### Fuente cuadrada

Plateau carrée · Quadratischen platte  
Square tray · Travessa quadrado

Ref	€	cm	h (cm)	U.Venta
63957	7,50	12x12	5,0	1
63958	15,80	19x19	6,0	1
63959	24,50	24x24	6,8	1



### Bol salsa mini

Bol sauce mini · Boul sauce min  
Sauce bowl mini · Bacia molho mini

Ref	€	cm	h (cm)	ml	U.Venta
63973	2,90	7,2x7,2	3,0	30	1



### Bol

Bol · Boul  
Bowl · Bacia

Ref	€	Ø (cm)	h (cm)	ml	U.Venta
63967	3,00	8,3	3,2	60	1
63968	4,80	9,5	4,6	130	1
63969	5,10	10,6	5,2	220	1
63970	7,00	12,6	6,0	300	1
63972	6,40	12,4	4,6	300	1



### Bol oval

Bol oval · Oval bowl  
Oval bowl · Bacia oval

Ref	€	cm	h (cm)	ml	U.Venta
63960	4,50	12x10	4,1	130	1
63971	7,80	16,3x12,3	4,7	220	1
63961	15,60	20,7x16,8	8,0	660	1
63962	24,30	24,2x20,6	9,3	1150	1



### Bol cónico

Conique bol · Boul Konish  
Conical bowl · Bacia cónica

Ref	€	Ø (cm)	h (cm)	ml	U.Venta
63946	8,80	15,7	5,9	330	1
63947	10,70	18,3	6,8	560	1
63948	14,10	21,3	7,8	750	1
63949	19,90	24,2	8,8	1350	1

# CLASSIC

## Colección



ES

· Una completa gama contemporánea en blanco y negro.  
· Diseñadas para realizar las creaciones del chef.

FR

· Une gamme complète contemporaine en noir et blanc.  
· Conçues pour rehausser les créations du chef.

EN

· Wide collection contemporary black and white pieces.  
· Designed to complete the chef's creations.

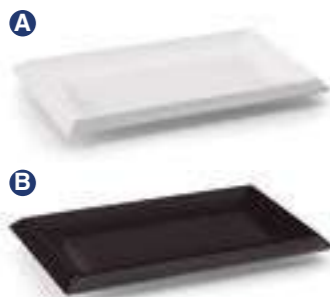

### Bandeja rectangular

Plateau rectangulaire · Serviertablet, rechteckig  
Rectangular tray · Bandeja rectangular

	Ref	€	cm	h (cm)	U.Venta
A	63531	8,60	26x16	2	6
	63532	14,40	30x22	2	6
B	63541	8,60	26x16	2	6
	63542	14,40	30x22	2	6



### Bandeja rectangular

Plateau rectangulaire · Serviertablet, rechteckig  
Rectangular tray · Bandeja rectangular

	Ref	€	cm	h (cm)	U.Venta
A	63535	37,30	53x32	3	6
	63536	54,20	70x30	2	3
B	63545	37,70	53x32	3	6
	63546	54,20	70x30	2	3

### Fuente oval

Plateau oval · Oval platte  
Oval tray · Travessa redonda

	Ref	€	cm	h (cm)	L	U.Venta
A	63557	9,70	32x12	6	0,85	6
	63558	15,50	41,5x17	8	2,20	6
B	63567	9,70	32x12	6	0,85	6
	63568	15,50	41,5x17	8	2,20	6



### Bandeja rectangular

Plateau rectangulaire · Serviertablet, rechteckig  
Rectangular tray · Bandeja rectangular

	Ref	€	cm	h (cm)	U.Venta
A	63533	18,60	30x21	3	6
	63534	22,00	35x21	2	6
B	63543	18,60	30x21	3	6
	63544	22,70	35x21	2	6



### Fuente pescado

Plateau poisson · Fischplatte  
Fish tray · Travessa peixe

	Ref	€	cm	h (cm)	U.Venta
A	63589	30,50	57x22	4	1
B	63599	30,50	57x22	4	1



### Bandeja delicatessen

Plateau delicatessen · Schüssel delicatessen  
Delicatessen tray · Bandeja delicatessen

	Ref	€	cm	U.Venta
A	63609	3,50	9,5x9,5	6
B	63619	3,50	9,5x9,5	6



### Fuente redonda WHITE

Plateau rond · Rundplatte  
Round tray · Travessa redonda

	Ref	€	Ø (cm)	h (cm)	U.Venta
	63551	28,90	40,0	6,0	6
	63552	38,40	44,5	6,5	1



### Fuente WHITE

Plateau · Serviertablet  
Tray · Travessa

	Ref	€	Ø (cm)	h (cm)	L	U.Venta
	63577	26,60	35,5	11	4,0	6



### Bol redondo WHITE

Bol rond · Schale rund  
Round bowl · Bacia redonda

	Ref	€	Ø (cm)	h (cm)	L	U.Venta
	63553	15,80	22	10,0	2,4	6
	63554	23,40	28	10,0	4,0	6
	63555	32,50	33	13,0	7,0	6
	63556	40,40	38	14,5	11,0	2



### Bandeja delicatessen

Plateau delicatessen · Schüssel delicatessen  
Delicatessen tray · Bandeja delicatessen

	Ref	€	cm	h (cm)	L	U.Venta
A	63610	3,00	10x10	2,5	0,12	6
B	63617	3,00	10x10	2,5	0,12	6



### Fuente cuadrada WHITE

Plateau rectangulaire · Serviertablet, rechteckig  
Rectangular tray · Travessa quadrada

	Ref	€	cm	h (cm)	L	U.Venta
	63573	28,20	33,5x33,5	8,5	5,0	1



### Portatartas

Guéridon pâtisserie · Kuchenplatte  
Cake stand · Porta-tartes

	Ref	€	Ø (cm)	h (cm)	U.Venta
	63586	32,50	33	9	4



### Bol oval WHITE

Bol oval · Schale oval  
Oval bowl · Bacia oval

	Ref	€	cm	h (cm)	L	U.Venta
	63585	23,70	29x26	16	4,0	6



### Ribbed bol

Ribbed bol · Schale gerippt  
Bowl Ribbed · Bacia Ribbed

	Ref	€	Ø (cm)	h (cm)	L	U.Venta
	63611	2,40	7,0	3	0,05	6
	63612	2,80	8,5	4	0,10	6



# WHITE & BLACK

## Colección



### ES

- Combina formas suaves y orgánicas con un diseño puro y elegante.
- Piezas en color blanco y negro, únicas y elegantes

### FR

- Allie des formes douces et organiques à un style pur et élégant.
- Pièces de couleur noire et blanche, uniques et élégantes.

### EN

- Soft and organic forms are combined with pure, stylish design.
- Unique and elegant white and black pieces.



### Bol cónico

Conique bol · Schale konisch  
Conical bowl · Bacia cónica

	Ref	€	Ø (cm)	h (cm)	L	U.Venta
	63261	9,60	17	7,0	0,70	6
A	63262	11,50	21	8,0	1,25	6
	63263	13,10	25	8,5	1,80	6
	63361	9,60	17	7,0	0,70	6
B	63362	11,50	21	8,0	1,25	6
	63363	13,10	25	8,5	1,80	6



### Bol oval

Bol oval · Oval bowl  
Oval bowl · Bacia ova

	Ref	€	cm	h (cm)	L	U.Venta
	63268	7,80	17x14	6	0,40	6
A	63269	17,50	24x20	9	1,70	6
	63368	7,80	17x14	6	0,40	6
B	63369	17,50	24x20	9	1,70	6

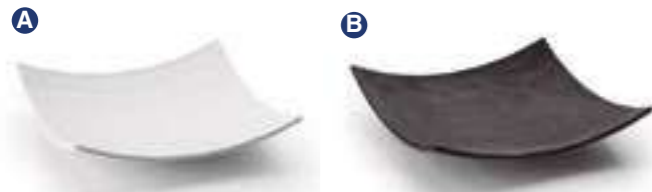

### Fuente cuadrada

Plateau carrée · Quadratischen platte  
Square tray · Travessa quadrado

	Ref	€	cm	h (cm)	U.Venta
	63272	7,40	19x19	4	6
A	63273	15,90	25x25	5	6
	63372	7,40	19x19	4	6
B	63373	15,90	25x25	5	6



### Bol redondo

Rond bol · Schale rund  
Bowl round · Bacia redonda

	Ref	€	Ø (cm)	h (cm)	L	U.Venta
	63264	7,60	12,5	7,5	0,45	6
A	63265	8,80	14,0	7,5	0,60	6
	63364	7,60	12,5	7,5	0,45	6
B	63365	8,80	14,0	7,5	0,60	6



### Fuente redonda

Plateau rond · Rundplatte  
Round tray · Travessa redonda

	Ref	€	Ø (cm)	h (cm)	L	U.Venta
A	63267	29,80	31	8	3,0	6
B	63367	29,80	31	8	3,0	6



### Fuente rectangular

Plateau rectangulaire · Serviertablet, rechteckig  
Rectangular tray · Travessa rectangular

	Ref	€	cm	h (cm)	U.Venta
A	63274	9,60	25x17,5	3	6
B	63374	9,60	25x17,5	3	6



### Fuente oval

Plateau ovale · Schale oval  
Oval tray · Travessa oval

	Ref	€	cm	h (cm)	U.Venta
A	63275	13,30	32x14	4	6
B	63375	13,30	32x14	4	6



### Fuente salsa mini

Plateau sauce mini · Serviertablet sauce mini  
Sauce tray mini · Travessa molho mini

	Ref	€	cm	h (cm)	U.Venta
A	63279	4,00	9x7	3	6
B	63379	4,00	9x7	3	6



### Bol salsa

Bac sauce · Schüssel saucen  
Sauce bowl · Bacia molho

	Ref	€	cm	h (cm)	L	U.Venta
A	63270	5,90	14x12	5	0,25	6
B	63370	5,90	14x12	5	0,25	6



### Vaso

Timbale · Trinkbecher  
Tumbler · Copo

	Ref	€	Ø (cm)	h (cm)	L	U.Venta
A	63350	3,40	7,3	7,7	0,32	1
B	63351	3,40	7,3	7,7	0,32	1



### Fuente 3 salsas

Plateau 3 sauces · Serviertablet 3 sauces  
3 sauces tray · Travessa 3 molhos

	Ref	€	cm	h (cm)	U.Venta
A	63280	5,50	19x8	3	6
B	63380	5,50	19x8	3	6



# STONE Colección



## ES

- Fabricadas en melamina de alta calidad. Libre de BPA.
- Combinan formas naturales con aspecto elegante parecido al mármol.
- Diseñadas para realzar las creaciones del chef.
- Ligeras, resistentes a golpes y choques térmicos.
- Higiénicas y fácilmente lavables, aptas para lavavajillas.

## FR

- Produits fabriqués en mélamine de grande qualité. Sans BPA.
- Ils allient des formes naturelles à un aspect élégant semblable au marbre.
- Conçus pour réaliser les créations du chef.
- Légers, résistants aux chocs et aux variations thermiques.
- Hygiéniques et faciles à laver, aptes pour le lave-vaisselle.

## EN

- Made of high quality melamine. BPA free.
- They combine natural forms with an elegant appearance that looks like marble.
- Designed to highlight the chef's creations.
- Lightweight and resistant to impacts and thermal shock.
- Hygienic, easy to wash and dishwasher safe.



### Plato redondo

Plateau rond · Rund Plate  
Round plate · Prato redondo

Ref	€	Ø (cm)	h (cm)	U.Venta
63180	35,00	35	3,0	1
63181	53,40	44	3,0	1
63182	80,00	55	3,0	1



### Bandeja cuadrada

Plateau carrée · Quadratischen platte  
Square tray · Travessa quadrado

Ref	€	cm	h (cm)	U.Venta
63187	25,30	28,5x28,5	0,9	1



### Bandeja rectangular

Plateau rectangulaire · Serviertablet, rechteckig  
Rectangular tray · Bandeja rectangular

Ref	€	cm	h (cm)	U.Venta
63188	30,50	35x28,5	0,9	1
63189	38,60	43x28,5	0,9	1
63190	57,10	53x32	0,9	1



### Fuente huevo

Plat oeufs · Eier platte  
Egg plate · Travessa ovo

Ref	€	cm	h (cm)	U.Venta
63184	34,20	40,7x30,5	4,3	1



### Fuente hoja

Palt feuille · Bratt platte  
Leaf plate · Travessa folha

Ref	€	cm	h (cm)	U.Venta
63191	21,40	40x25,3	4,3	1
63192	38,00	53x33	4,3	1



### Fuente oval

Carrée ovale · Schale oval  
Oval tray · Travessa oval

Ref	€	cm	h (cm)	U.Venta
63183	45,90	65x26	3,0	1



### Tabla con mango

Planche avec manche · Servierbrett mit Griff  
Board with grip · Tábua com mango

Ref	€	cm	h (cm)	U.Venta
63185	23,40	40x19,5	0,9	1
63186	32,10	46x25	0,9	1

# MAGMA

## Colección



ES

- Fabricadas en melamina de alta calidad.
- Libres de BPA.
- Ofrecen un aspecto muy natural parecido al hierro fundido.
- Ideales para servir y presentar los platos más exquisitos.

FR

- Fabriqué en mélamine de haute qualité.
- Sans BPA.
- Aspect très naturel, semblable à la fonte d'aluminium.
- Idéale pour servir et présenter les plats les plus exquis.

EN

- Made of high quality melamine.
- BPA free.
- Very natural appearance similar to cast iron.
- Perfect for serving and presenting the most exquisite dishes.



### Cacerola redonda

Faitout rond · Rund Bratentopf  
Round casserole · Caçarola redonda

Ref	€	Ø (cm)	U.Venta
63384	5,10	16	12
63385	6,20	18	12



### Cacerola oval

Faitout ovale · Oval Bratentopf  
Oval casserole · Caçarola roval

Ref	€	cm	U.Venta
63388	4,50	18x12	12
63389	5,80	21x15	12



### Wok

Wok · Wok  
Wok · Wok

Ref	€	Ø (cm)	U.Venta
63386	4,30	15	12
63387	5,90	18	12



### Mini grill

Mini grill · Mini grill  
Mini grill · Mini grill

Ref	€	cm	U.Venta
63382	7,40	13,5x13,5	6



### Mini sartén

Mini pøele · Mini Pfanne  
Mini frying pan · Mini sertã

Ref	€	Ø (cm)	U.Venta
63381	7,00	15	6



### Mini sartén rectangular

Mini pøele rectangulare · Mini Pfanne, rechteckiger  
Rectangular Mini frying pan · Mini sertã rectangular

Ref	€	cm	U.Venta
63383	5,10	17x11,5	12

# MINI-COCOTTES

## Colección



ES

- Fabricadas en melamina de alta calidad. Libres de BPA.
- Ofrecen un aspecto muy natural parecido al hierro fundido.
- Ideales para servir y presentar los platos más exquisitos.

FR

- Fabriqué en mélamine de haute qualité. Sans BPA.
- Aspect très naturel, semblable à la fonte d'aluminium.
- Idéale pour servir et présenter les plats les plus exquis.

EN

- Made of high quality melamine. BPA free.
- Very natural appearance similar to cast iron.
- Perfect for serving and presenting the most exquisite dishes.

### Cacerola BLACK

Faitout · Bratentopf  
Casserole · Caçarola

	Ref	€	Ø (cm)	h (cm)	ml	U.Venta
A	63390	4,40	9	4,5	150	1
B	63391	11,80	18x8,5	5,0	480	1
C	63392	11,10	10	4,5	210	1
	63393	20,10	14	6,5	640	1

A



B



C



### Cacerola RED

Faitout · Bratentopf  
Casserole · Caçarola

	Ref	€	Ø (cm)	h (cm)	ml	U.Venta
A	63394	4,40	9	4,5	150	1
B	63395	11,80	18x8,5	5,0	480	1
C	63396	11,10	10	4,5	210	1
	63397	20,10	14	6,5	640	1

A



B



C



### Cacerola GREY

Faitout · Bratentopf  
Casserole · Caçarola

	Ref	€	Ø (cm)	h (cm)	ml	U.Venta
A	63398	4,40	9	4,5	150	1
B	63399	11,80	18x8,5	5,0	480	1
C	63400	11,10	10	4,5	210	1
	63401	20,10	14	6,5	640	1

A



B



C



# CUBETAS GN

## Colección



1/4  
265 x 162 mm



**Cubeta 1/4**  
Bac 1/4 · GN-Behälter 1/4  
Container 1/4 · Caixa 1/4

	Ref	€	h (mm)	L	U.Venta
A	66465E	15,50	65	1,90	1
	66410E	17,40	100	2,50	1
B	66465J	16,50	65	1,90	1
	66410J	18,60	100	2,50	1

2/3  
350 x 325 mm



**Cubeta 2/3**  
Bac 2/3 · GN-Behälter 2/3  
Container 2/3 · Caixa 2/3

	Ref	€	h (mm)	L	U.Venta
A	66565E	33,30	65	5,50	1
B	66565J	34,80	65	5,50	1

1/6  
176 x 162 mm



**Cubeta 1/6**  
Bac 1/6 · GN-Behälter 1/6  
Container 1/6 · Caixa 1/6

	Ref	€	h (mm)	L	U.Venta
A	66665E	11,10	65	1,10	1
	66610E	12,40	100	1,60	1
B	66665J	11,80	65	1,10	1
	66610J	13,30	100	1,60	1

2/4  
530 x 165 mm



**Cubeta 2/4**  
Bac 2/4 · GN-Behälter 2/4  
Container 2/4 · Caixa 2/4

	Ref	€	h (mm)	L	U.Venta
A	66765E	23,20	65	4,50	1
B	66765J	24,00	65	4,50	1

### ES

- Fabricadas en melamina de alta calidad.
- Libres de BPA.
- Ligeras, indeformables y apilables.
- Higiénicas y fácilmente lavables.
- Aptas para procesos de refrigeración, congelación o distribución de alimentos.

### FR

- Fabriqué en mélamine de haute qualité.
- Sans BPA.
- Légères, indéformables et empilables.
- Hygiéniques et facilement lavables.
- Compatibles pour des processus de réfrigération, congélation ou distribution d'aliments.

### EN

- Made of high quality melamine.
- BPA free.
- Light, non-deformable and stackable.
- Hygienic and easily washable.
- Suitable for refrigeration and freezing processes and food distribution

1/1  
530 x 325 mm



**Cubeta 1/1**  
Bac 1/1 · GN-Behälter 1/1  
Container 1/1 · Caixa 1/1

	Ref	€	h (mm)	L	U.Venta
A	66165E	44,20	65	8,50	1
	66110E	50,30	100	13,30	1
B	66165J	47,00	65	8,50	1
	66110J	52,90	100	13,30	1

1/2  
265 x 325 mm



**Cubeta 1/2**  
Bac 1/2 · GN-Behälter 1/2  
Container 1/2 · Caixa 1/2

	Ref	€	h (mm)	L	U.Venta
A	66265E	23,10	65	4,50	1
	66210E	25,60	100	8,00	1
B	66265J	24,10	65	4,50	1
	66210J	27,20	100	8,00	1

1/3  
176 x 325 mm



**Cubeta 1/3**  
Bac 1/3 · GN-Behälter 1/3  
Container 1/3 · Caixa 1/3

	Ref	€	h (mm)	L	U.Venta
A	66365E	18,00	65	2,50	1
	66310E	20,00	100	3,80	1
B	66365J	19,30	65	2,50	1
	66310J	21,40	100	3,80	1

# MANTELES DE MESA

## Colección

Cuero 100% reciclado  
Leather 100% recycled

OEKO-TEX®  
CONFIRMA EL CUERO  
LEATHER STANDARD



Se pueden personalizar en seco  
Can be customized in dry

### ES

- Fabricados en cuero 100% reciclado.
- Espesor de 1,5 y 2,1 mm.
- Disponibles en tres formatos; cuadrado, redondo y forma oval.
- Resistentes a altas temperaturas y manchas.
- Aislantes del calor.
- Impermeables.
- Se limpian fácilmente con solución hidroalcohólica sin dañar el producto.
- Perfectos para vestir y proteger las mesas de restaurantes, cafeterías y hasta el propio hogar.

### FR

- Fabriqués en cuir 100% recyclé.
- Épaisseur de 1,5 et 2,1 mm.
- Disponibles en trois formats : carrés, ronds et forme ovale.
- Résistants aux hautes températures et aux taches.
- Isolants de la chaleur.
- Imperméables.
- Se nettoient facilement avec un chiffon humide, du désinfectant, etc.
- Parfaits pour habiller et protéger les tables des restaurants, des cafétérias, et même pour un usage domestique.

### EN

- Made of 100% recycled leather.
- 1.5 mm and 2.1 mm Thickness.
- Available in three formats: square, round and oval shaped.
- Resistant to high temperatures and stains. Heat insulating.
- Waterproof.
- Easy to clean with a damp cloth, disinfectant, etc.
- Perfect for decorating and protecting tables in restaurants, cafés and even at home.



### Mantel individual rectangular

Nappe individuelle rectangulaire · Tischset, rechteckiger  
Rectangular individual placemat · Toalhas de mesa individual rectangular

	Ref	€	cm	e (mm)	Color	U.Venta	
A	66831	19,40	45x30	1,5	Marrón · Brown	1	MILOS
B	66832	19,40	45x30	1,5	Antracita · Anthracite	1	CRETA
C	66833	20,10	45x30	2,1	Marrón granulado · Grained brown	1	RINIA
D	66834	20,10	45x30	2,1	Negro granulado · Grainy Black	1	COS

Servicio mesa  
Table service



### Mantel individual redondo

Nappe individual rond · Tischset, rund  
Round individual placemat · Toalhas de mesa individual redondo

	Ref	€	Ø (cm)	e (mm)	Color	U.Venta
	66835	22,90	40	1,5	Marrón · Brown	1 MILOS
<b>A</b>	66836	22,90	40	1,5	Antracita · Anthracite	1 CRETA
<b>B</b>	66837	24,10	40	2,1	Marrón granulado · Grained brown	1 RINIA
<b>C</b>	66838	24,10	40	2,1	Negro granulado · Grainy Black	1 COS

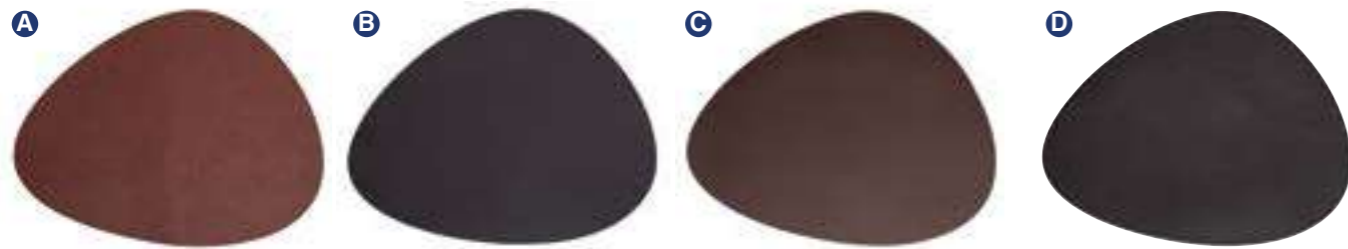

### Mantel individual oval

Nappe individual ovale · Tischset, oval  
Oval individual placemat · Toalhas de mesa individual oval

	Ref	€	cm	e (mm)	Color	U.Venta
	66839	21,00	45x35	1,5	Marrón · Brown	1 MILOS
<b>A</b>	66840	21,00	45x35	1,5	Antracita · Anthracite	1 CRETA
<b>B</b>	66841	22,00	45x35	2,1	Marrón granulado · Grained brown	1 RINIA
<b>C</b>	66842	22,00	45x35	2,1	Negro granulado · Grainy Black	1 COS



**Fabricados en PVC 100%**  
Fait de 100% PVC / Hergestellt aus 100% PVC  
Made of 100% PVC / Feita de 100% PVC

### Mantel individual

Nappe individuel · Tischset  
Individual placemat · Toalha de mesa individual

	Ref	€	cm	U.Venta
<b>A</b>	66784	6,90	45x30	6 MASBATE
<b>B</b>	66785	6,90	45x30	6 LEYTE



**Fabricados en PVC 100%**  
Fait de 100% PVC / Hergestellt aus 100% PVC  
Made of 100% PVC / Feita de 100% PVC

### Mantel individual

Nappe individuel · Tischset  
Individual placemat · Toalha de mesa individual

	Ref	€	cm	U.Venta
<b>A</b>	66787	6,90	45x30	6 DAVAO
<b>B</b>	66788	6,90	45x30	6 TICAO

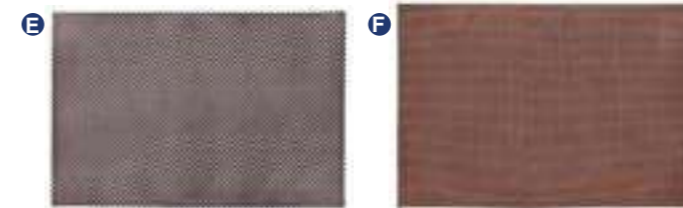

**Fabricados en 75% PVC + 25% Polyester**  
Fait de 75% PVC + 25% Polyester / Hergestellt aus 75% PVC + 25% Polyester  
Made of 75% PVC + 25% Polyester / Feita de 75% PVC + 25% Polyester

### Mantel individual

Nappe individuel · Tischset  
Individual placemat · Toalha de mesa individual

	Ref	€	cm	U.Venta
<b>A</b>	66772	4,80	45x30	6 LANTA
<b>B</b>	66773	4,80	45x30	6 KOTAO
<b>C</b>	66780	4,70	45x30	6 SUMBA
<b>D</b>	66781	4,70	45x30	6 BIAK
<b>E</b>	66782	4,70	45x30	6 GILI
<b>F</b>	66783	4,70	45x30	6 RINCA



**Fabricados en 75% PVC + 25% Polyester**  
Fait de 75% PVC + 25% Polyester / Hergestellt aus 75% PVC + 25% Polyester  
Made of 75% PVC + 25% Polyester / Feita de 75% PVC + 25% Polyester

### Camino de mesa

Chemin de table · Tischläufer  
Table runner · Corre mesa

	Ref	€	cm	U.Venta
<b>A</b>	66790	10,60	40x140	1 BORNEO
<b>B</b>	66791	10,60	40x140	1 MANGOLE
<b>C</b>	66792	10,60	40x140	1 SIPURA
<b>D</b>	66793	10,60	40x140	1 TIMOR

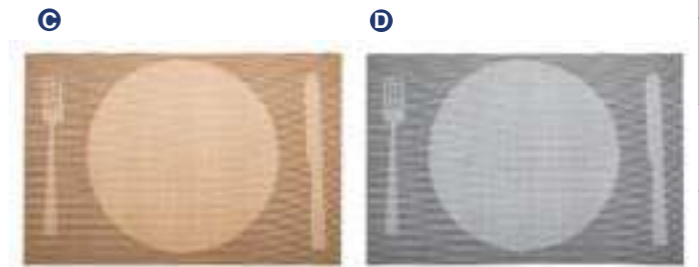
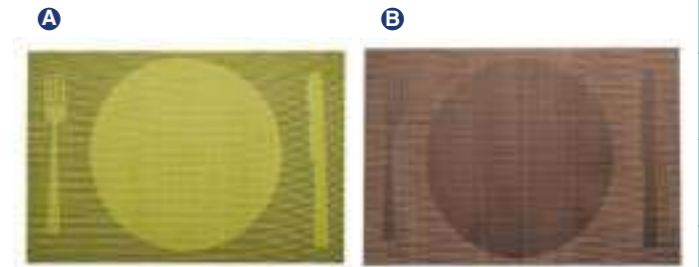

**Fabricados en 75% PVC + 25% Polyester**  
Fait de 75% PVC + 25% Polyester / Hergestellt aus 75% PVC + 25% Polyester  
Made of 75% PVC + 25% Polyester / Feita de 75% PVC + 25% Polyester

### Mantel individual

Nappe individuel · Tischset  
Individual placemat · Toalha de mesa individual

	Ref	€	cm	U.Venta
<b>A</b>	66755	4,30	45x30	6 SAMUI
<b>B</b>	66756	4,30	45x30	6 KRABI
<b>C</b>	66757	4,30	45x30	6 TAPU
<b>D</b>	66758	4,30	45x30	6 SAMET

# SALVAMANTELES

## Colección



ES

- Salvamantel magnético fabricado en roble de máxima calidad, muy agradable al tacto (63041).
- Salvamantel magnético fabricado en silicona de máxima calidad (63042).
- Diseñado para apoyar y transportar sartenes, ollas, cacerolas, etc. de forma cómoda y segura, sin riesgo a quemarse.
- Superresistente a altas temperaturas. Protege las superficies y las encimeras.
- No es apto para el lavavajillas.

FR

- Dessous de plat magnétique fabriqué en chêne de la plus grande qualité, très agréable au toucher (63041).
- Dessous de plat magnétique fabriqué en en silicone de qualité supérieure (63042).
- Conçu pour transporter et y poser des poêles, des casseroles, des faitouts, etc. de façon pratique et sûre, sans risquer de se brûler.
- Très résistant aux hautes températures. Protège les surfaces et les plans de travail.
- Ne peut pas être mis au lave-vaisselle.

EN

- Magnetic trivet made of top quality oak with a very nice feel (63041).
- Magnetic trivet made of top quality silicone (63042).
- Designed to hold and move frying pans, pots, casseroles etc. safely and conveniently without risk of getting burned.
- Extremely resistant to high temperatures. Protects surfaces and counter tops.
- Not dishwasher safe.

Roble  
Oak



**Fuerte sujeción. Potente imán integrado**  
Strong holding power. Powerful built in magnet

### Salvamanteles magnético

Dessous de plat magnétique · Untersatzer, magnetisch  
Magnetic trivet · Base para tachos magnética

Ref	€	cm	h (cm)	U.Venta
63041	21,20	23x20	1	1

Si  
Silicone  
Dishwasher



**Base imantada GRIP line**  
4 potentes imanes integrados  
Magnet base GRIP line  
4 strong magnet integrated

### Salvamanteles magnético GRIP

Dessous de plat magnétique · Untersatzer, magnetisch  
Magnetic trivet · Base para tachos magnética

Ref	€	Ø (cm)	h (cm)	U.Venta
63042	8,30	20	0,6	1

Si  
Silicone  
Dishwasher



**Flexible y antideslizante**  
Superresistente a altas temperaturas  
Flexible and non-slip  
Extremely resistant to high temperatures

### Salvamanteles UNITE

Dessous de plat · Untersatzer  
Trivet protector · Protector de toalhas

Ref	€	cm	h (cm)	U.Venta
63043	4,10	16x16	1	1

Inox  
Si  
Silicone



Cerrado · closed  
12,5x12,5 cm

**Muy cómodo para guardar y sencillo de utilizar**  
Very convenient to store and easy to use

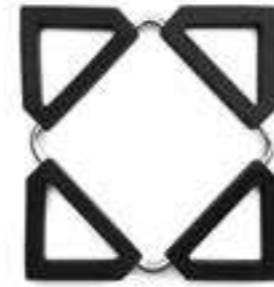

**Proporcionan adherencia**  
Salvamanteles desplegable  
Soporte de acero inoxidable  
They provide adherence  
Trivet foldable  
Stainless steel bracket

### Salvamanteles desplegable

Dessous de plats dépliant · Untersatz  
Trivet foldable · Protector de toalhas dobrável

Ref	€	cm	U.Venta
66752	11,10	16x16	1

Fe  
Hierro  
Iron



### Salvamanteles

Dessous de plats · Untersatz  
Trivet protector · Protector de toalhas

Ref	€	cm	h (cm)	Varilla (mm)	U.Venta
61129	13,30	18,5x18,5	2,9	5x3	1
61130	17,30	25x25	2,9	5x3	1
61131	17,30	30x20	2,9	5x3	1
61132	23,70	40x25	2,9	5x3	1

Inox  
18/10

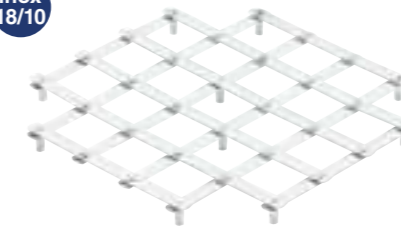

### Salvamanteles

Dessous de plats · Untersatz  
Trivet protector · Protector de toalhas

Ref	€	cm	h (cm)	U.Venta
63008	18,40	23x23	2,5	1

Inox



### Salvamanteles redondo

Dessous de plats rond · Untersatz rund  
Round trivet protector · Protector de toalhas redondo.

Ref	€	cm	h (cm)	U.Venta
63036	16,40	20x18	2	1

# CUBERTEROS

## Colección

- Ideal para organizar y guardar los cubiertos e utensilios de la cocina.
- No se deforma con el peso de los cubiertos.
- Apilable.

- Ideal for organizing and storing cutlery and kitchen utensils.
- It does not deform with the weight of the cutlery.
- Stackable.



**4 compartimentos**  
4 compartments  
Hueco · Hollow: 11x25x9 cm



### Cubterero GN 1/1

Range-couverts · Besteckkasten  
Cutlery holder · Bandeja pata talheres

Ref	€	cm	h (cm)	U.Venta
33121	11,20	52,5x32	9,5	1

PP  
Polypropylene  
Dishwasher  
BPA free



**Bastidor cromado reforzado**  
Reinforced chrome frame

### Cubterero RATTAN PP

Range-couverts · Besteckkasten  
Cutlery holder · Bandeja pata talheres

Ref	€	cm	h (cm)	Comp.	U.Venta
63484	8,40	27x10	4,5	1	1
63485	8,40	Ø12	15,0	1	1
63491	74,80	53x32,5	9,0	4	1

# PANERAS · FRUTEROS

## Colección



- Cuerpo fabricado en acero al carbono lacado en blanco.
- Tapa fabricada en madera de caucho con orificios de ventilación para una óptima circulación del aire.
- Diseño vintage. Forma rectangular con esquinas redondeadas.
- Diseñado para conservar el pan y otros productos siempre frescos.
- 2 en 1: la tapa de madera de caucho se puede utilizar como tabla de cortar.
- Almacenamiento compacto.

- The body is made of carbon steel with white lacquer.
- The lid is made of rubberwood with ventilation holes for optimum air circulation.
- It has a vintage design. It is rectangular with rounded corners.
- It is designed to keep bread and other products always fresh.
- 2 in 1: The rubberwood lid can be used as a cutting board.
- Compact storage.



### Panera NÓRDICA

Boîte à pain · Brotkasten  
Bread basket · Caixa para guardar pão

Ref	€	cm	h (cm)	U.Venta
A 62868	38,60	30x18	12,5	1
B 62869	41,90	42x22,5	12,5	1

**Puerta abatible. Capacidad para todo tipo de panes**  
Mantiene el pan protegido, prolonga su conservación  
Folding door. Capacity for all kinds of breads  
Keeps the bread protected and prolong its conservation

Inox



### Panera abatible

Paniere rabattable · Abfallen Brotkorb  
Bread bin foldable lid · Cestonreclinável

Ref	€	cm	h (cm)	U.Venta
62944	41,90	44x29	19	1

Inox



### Frutero - Panera INOX

Paniere à fruit et à pain · Brot-/Obstschale  
Fruits and bread basket · Fruteiro-Cesto

Ref	€	Ø (cm)	U.Venta
61821	7,50	20	1
61823	11,30	24	1



### Panera KRAFT

Boîte à pain · Brotkasten  
Bread basket · Caixa para guardar pão

Ref	€	cm	h max (cm)	h min (cm)	U.Venta
A 63476	13,40	10x10	25	8	1
B 63477	14,30	12x12	25	12	1
C 63478	16,20	15x15	25	12	1
D 63479	18,70	20x20	33	12	1



### Panera TEX

Boîte à pain · Brotkasten  
Bread basket · Caixa para guardar pão

Ref	€	cm	h max (cm)	h min (cm)	U.Venta
A 63486	13,40	10x10	25	8	1
B 63487	14,30	12x12	25	12	1
C 63488	16,20	15x15	25	12	1
D 63489	18,70	20x20	33	12	1

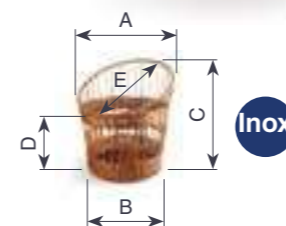

Inox

Estructura de refuerzo de acero inoxidable  
Stainless steel reinforcement structure

### Cesta baguette

Corbeille · Brotkorb  
Basket · Cesta

Ref	€	ØA (cm)	ØB (cm)	C (cm)	D (cm)	E (cm)	U.Venta
A 63492	62,70	32,0	28,5	42,0	25,0	36,5	1
B 63493	62,70	32,0	28,5	42,0	25,0	36,5	1



- Fabricadas en fibra virgen natural.
- Material ecológico y respetuoso con el medio ambiente.
- Lavables, resistentes y duraderas.
- Diseñadas y fabricadas en España.
- Hechas a mano.
- Tacto agradable y suave, similar a la piel.
- Espesor 0,55 mm.

- Fabriquéés en fibres vierges naturelles.
- Matériau écologique et respectueux de l'environnement.
- Lavables, résistantes et durables.
- Conçues et fabriquées en Espagne.
- Faites à la main.
- Toucher agréable et doux, similaire au cuir.
- Épaisseur de 0,55 mm.

- Made of natural virgin fibre.
- Ecological material respectful with the environment.
- Washable, resistant and durable.
- Designed and manufactured in Spain.
- Handmade.
- Nice soft feel, similar to leather.
- Thickness 0.55 mm.



- Cestas para pan fabricadas en polipropileno.
- Diseñadas para uso intensivo.
- Estructura de refuerzo de acero inoxidable. Parte trasera más alta que proporciona suficiente apoyo para panes largos (63492-63493).
- Material con aspecto de mimbre muy resistente, libre de BPA.
- Elaboradas a mano.
- Prácticas e higiénicas. Acabado en mate.
- Ideales para almacenar y exponer panes.
- Apilables.
- Fácil limpieza.

- Paniers pour pain fabriqués en polypropylène.
- Conçu pour une utilisation intensive.
- Structure renforcée en acier inoxydable. Partie arrière plus haute afin d'offrir un meilleur support aux pains longs (63792-63493).
- Matériau très résistant à l'aspect de rotin, sans BPA.
- Fait à la main.
- Pratiques et hygiéniques. Fini mat.
- Parfaits pour ranger et exposer des pains.
- Empilables.
- Faciles à nettoyer.

- These bread baskets are made of polypropylene.
- Designed for intensive use.
- Stainless steel reinforcement structure. The taller back gives plenty support for long loaves of bread (63792-63493).
- The very strong material looks like wicker and it's BPA free.
- Handmade.
- They're practical and hygienic. Matte finish.
- Perfect for storing or displaying bread.
- Stackable.
- Easy to clean.



### Cesta de pan redonda

Corbeille a pain ronde · Brotkorb, rund  
Round bread basket · Cesta de pão redonda

	Ref	€	Ø (cm)	h (cm)	U.Venta
	63471	7,70	19	8	1
<b>A</b>	63472	8,60	21	8	1
	63473	9,20	23	8	1
	63474	9,80	28	8	1
	63871	7,80	19	8	1
<b>B</b>	63872	8,60	21	8	1
	63873	9,20	23	8	1
	63874	9,90	28	8	1



### Cesta de pan oval

Corbeille a pain ovale · Brotkorb, Oval  
Oval bread basket · Cesta de pão oval

	Ref	€	cm	h (cm)	U.Venta
	63480	7,00	19x14	8,0	1
<b>A</b>	63481	8,30	24x17	8,0	1
	63482	10,10	28x16	8,5	1
	63880	7,00	19x14	8,0	1
<b>B</b>	63881	8,20	24x17	8,0	1
	63882	10,10	28x16	8,5	1



### Cesta de pan

Corbeille a pain · Brotkorb  
Bread basket · Cesta de pão

	Ref	€	Ø (cm)	h (cm)	U.Venta
<b>A</b>	63494	30,00	35	20	1
<b>B</b>	63894	29,50	35	20	1



### Cesta de pan cuadrada

Corbeille a pain carré · Brotkorb, vierekig  
Square bread basket · Cesta de pão quadrada

	Ref	€	cm	h (cm)	U.Venta
<b>A</b>	63490	34,30	53x33,5	9	1
<b>B</b>	63890	34,00	53x33,5	9	1

# New

Medidas · Sizes  
19,5x17,5x7 cm

Medidas · Sizes  
29x18x8 cm



### Frutero DUAL SQ

Corbeille à fruits · Obstkorb  
Fruit basket · Fruteira

Ref	€	cm	h (cm)	U.Venta
61124	18,80	29x18,5	33,5	1

Madera contrachapada color haya  
Plywood beech color



### Frutero varillas

Corbeille à fruits · Obstschale aus Gitterstäben  
Square fruit bowl · Cesto de metal para fruta

	Ref	€	Cesta (cm)	h Total (cm)	ØVarilla (mm)	U.Venta
<b>A</b>	61137	34,40	26x26x18,3	27,8	4	1
<b>B</b>	61138	34,40	Ø25,2x17,7	28,9	4	1



### Frutero varillas DUAL

Corbeille à fruits · Obstschale aus Gitterstäben  
Rod fruit bowl · Cesto de metal para fruta

Ref	€	Grande (cm)	Peq. (cm)	h (cm)	ØVarilla (mm)	U.Venta
61140	53,40	Ø40x10	Ø24x10	63	4	1

- Frutero de doble altura fabricado en metal y acabado negro mate.
- Asa fabricada en madera de caucho.
- Diseño transpirable: permite que el aire circule mejor, manteniendo así las frutas y verduras siempre frescas.
- 100% estable y resistente.
- Desmontable: las cestas se pueden utilizar por separado.
- Versátil: ideal para fruta, verdura, tarros de conservas, etc.

- Corbeille à fruits à double hauteur fabriquée en métal et finition noir mat.
- Poignée fabriquée en bois de caoutchouc.
- Conception aérée : permet à l'air de mieux circuler, maintenant ainsi les fruits et les légumes toujours frais.
- 100% stable et résistante.
- Démontable : les paniers peuvent être utilisés séparément.
- Polyvalente : idéale pour les fruits, les légumes, pots de conserve, etc.
- Two tier fruit basket made of metal with a matte black.
- Handle made of rubber wood.
- The breathable design lets air circulate better to keep your fruit and vegetables fresh all the time.
- 100% stable and resistant.
- Detachable: the baskets can be used separately.
- Versatile: perfect for fruit, vegetables, canning jars, etc.

Madera aglomerada  
Agglomerate wood

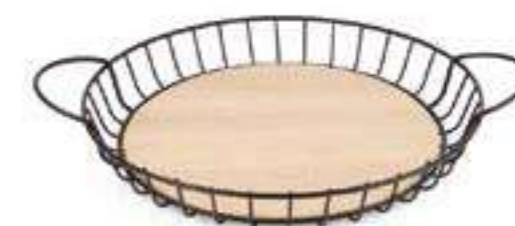

### Frutero varillas redondo bajo

Corbeille à fruits ronde basse · Obstschale aus Gitterstäben  
Round low rod fruit bowl · Cesto de metal para fruta redondo baixo

Ref	€	Cesta (cm)	h (cm)	Ø Base (mm)	ØVarilla (mm)	U.Venta
61139	39,70	Ø39x6	7,6	31,3	4	1



Ideales para almacenar fruta, pan, verduras, huevos, etc.  
Can be used for storing fruit, bread, vegetables, eggs, etc.

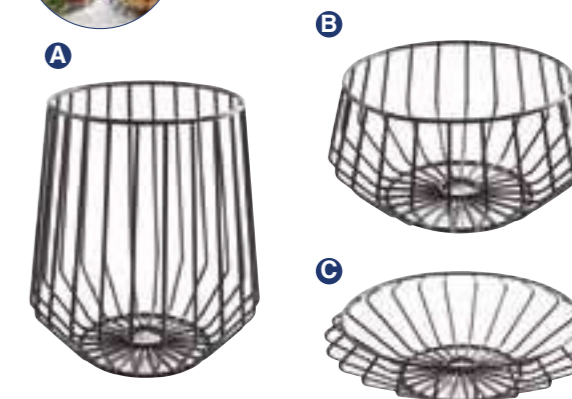

### Frutero varillas

Corbeille à fruits · Obstschale aus Gitterstäben  
Rod fruit bowl · Cesto de metal para fruta

	Ref	€	Ø (cm)	h (cm)	ØVarilla (mm)	U.Venta
<b>A</b>	61126	22,90	23,4	25,4	4	2
<b>B</b>	61127	20,80	27,0	13,8	4	1
<b>C</b>	61128	22,00	34,0	9,5	4	1



# GREY PLUS

## Fondue



**New**

### ES

- Fondue eléctrica acabada en acero inoxidable de gran calidad. 1500W de potencia.
- Ideal para fundir queso, chocolate o calentar aceite.
- Olla de acero inoxidable desmontable y de 1,2 L de capacidad con fondo termodifusor para una distribución uniforme del calor.
- Termostato regulable para calentar y mantener los ingredientes siempre calientes.
- Protector antisalpicaduras extraíble con soporte para 8 tenedores.
- Incluye 8 tenedores de acero inoxidable y marcas de colores.
- Apagado de seguridad contra sobrecalentamiento.
- Pies antideslizantes. 100% estable.
- Olla, protector y tenedores aptos para el lavavajillas.

### FR

- Appareil à fondue électrique avec finition en acier inoxydable de grande qualité. 1500W de puissance.
- Idéal pour faire fondre du fromage, du chocolat, ou faire chauffer de l'huile.
- Récipient en acier inoxydable démontable d'une capacité de 1,2 L avec fond thermodiffuseur pour une distribution uniforme de la chaleur.
- Thermostat réglable pour chauffer et maintenir les ingrédients toujours chauds.
- Couvercle de protection anti-éclaboussures extractible avec support pour 8 fourchettes.
- Inclut 8 fourchettes en acier inoxydable identifiées par différentes couleurs.
- Arrêt de sécurité contre la surchauffe.
- Pieds antidérapants. 100% stable.
- Récipient, couvercle et fourchettes compatibles avec le lave-vaisselle.

### EN

- High quality stainless steel electric fondue set. 1500 W power.
- Ideal for melting cheese, chocolate or heating oil.
- 1.2 L removable stainless steel pot with thermo-diffuser bottom for even heat distribution.
- Adjustable thermostat to heat and keep the ingredients hot at all times.
- Removable splash guard lid that holds 8 forks.
- Includes 8 stainless steel colour marked forks.
- Overheating safety function.
- Non-slip feet. 100% stable.
- Dishwasher safe pot, lid and forks



### Fondue GREY PLUS

Fondue · Fondue  
Fondue · Fondue

Ref	€	W	L	U.Venta
69399	99,20	1500	1,20	1

Ref	Tensión/Voltage	Potencia/Power	Temperat./Temp.	Aceite/Oil	Capacidad/Capacity	Dimensiones/Sizes	Peso/Weight
69399	220-240 V; 50/60 Hz	1500 W	40°C - 95°C	190°C	1,20 L	29,5x21,5x24,5 cm	2,60 Kg

# ROSSO

## Fondue



### ES

- Fondue fabricada en hierro fundido esmaltado de máxima calidad.
- Interior y exterior esmaltado que garantiza una distribución del calor uniforme sin puntos de sobrecalentamiento.
- No absorbe la humedad, los sabores, ni los olores de los alimentos.
- Diseñado para preparar deliciosas fondues de chocolate, queso, verduras, carne, etc.
- Gracias a sus dos asas laterales se puede transportar de forma segura.
- Cuenta con protección contra las salpicaduras, soporte de hierro colado y base de madera para mayor estabilidad. Además, incluye quemador de gel combustible (gel no incluido).
- La olla tiene 16,5 cm de diámetro y una capacidad de 1,2 L.
- Apta para todas las fuentes de calor, incluida la inducción.
- Incluye 6 tenedores de acero inoxidable con mango de madera y marcas de colores.

### FR

- Appareil à fondue fabriqué en fonte d'aluminium émaillée de la plus grande qualité.
- Intérieur et extérieur émaillés, garantissant ainsi une distribution uniforme de la chaleur sans points de surchauffe.
- N'absorbe ni l'humidité, ni les goûts, ni les odeurs des aliments.
- Conçu pour préparer de délicieuses fondues au chocolat, fromage, légumes, viande, etc.
- Grâce à ses deux poignées latérales, il peut être transporté en toute sécurité.
- Possède une protection contre les éclaboussures, un support en métal coulé et une base en bois pour une meilleure stabilité. De plus, il inclut un brûleur de gel combustible (gel non inclus).
- Le récipient mesure 16,5 cm de diamètre et a une capacité de 1,2 L.
- Apte pour toutes les sources de chaleur, y compris l'induction.
- Inclut 6 piques en acier inoxydable avec manche en bois et marques de couleur.

### EN

- Fondue pot made of top quality enamelled cast iron.
- Enamelled inside and out to guarantee even heat distribution without overheating points.
- Does not absorb humidity, flavours or odours from food.
- Designed to prepare delicious fondue with chocolate, cheese, vegetables or meats, etc.
- It can be handled safely thanks to its two side handles.
- It has splash protection, a cast iron support and a wooden base for greater stability. It also has a flammable gel burner (gel not included).
- The pot is 16.5 cm in diameter and has a 1.2 L capacity.
- It can be used with all heat sources, including induction.
- There are 6 stainless steel forks with wooden handles and coloured marks included.

Prepara deliciosas fondues de chocolate, queso, verduras, carne, etc.  
Prepare delicious fondue with chocolate, cheese, vegetables or meats, etc.



### Fondue ROSSO

Fondue · Fondue  
Fondue · Fondue

Ref	€	L	U.Venta
71711	62,20	1,20	1



**Gel de origen orgánico. No produce emanaciones tóxicas. Encendido rápido y combustión silenciosa, limpia, inodora, sin humos y sin cenizas.**  
Organic gel fuel. Does not produce toxic fumes. Quick-lighting and quiet-burning, clean, odourless, smokeless and ash-free.

### Gel combustible ETANOL

Gel chauffe ETHANOL · Brennpaste, ETHYALKOHOL  
Fuel gel, ETHANOL · Gel combustible ETANOL

Ref	€	Kg	Horas	U.Venta
A 71780	4,80	0,08	80 min	1
B 69108	2,70	0,225	3	72
C 69107	8,60	0,840	-	1
D 69109	39,40	4,00	-	1

# MINI Colección



## ES

- Fabricadas en aluminio fundido de máxima calidad.
- Ideal tanto para cocinar como para presentar aperitivos o platos.
- Antiadherente bicapa de alta calidad y 100% libre de PFOA.
- Libres de materiales tóxicos, pesados, disolventes y sustancias químicas.
- Diseñadas para una cocina saludable: permite cocinar sin apenas aceite garantizando que los alimentos no se peguen.
- Distribución homogénea del calor que permite una cocción rápida y uniforme.
- Aptas para todo tipo de fuegos: gas, eléctrica, vitrocerámica e inducción.
- Tapa fabricada en vidrio templado con válvula de salida de vapor.
- Pomo baquelita con acabado Soft Touch.
- Mango ergonómico con acabado Soft Touch.



### Cacerola con tapa

Faitout avec couvercle · Bratentopf mit Deckel  
Casserole with lid · Caçarola com tampa

Ref	€	Ø (cm)	ØBase (cm)	h (mm)	e (mm)	L	U.Venta
25160	20,90	16	12,0	5,0	1,6	0,8	1



### Paellera

Plat à paella · Pfanne  
Round dish · Paelheira

Ref	€	Ø (cm)	ØBase (cm)	h (mm)	e (mm)	L	U.Venta
25161	20,90	20	11,5	4,5	1,8	1,0	1



### Grill

Grill · Grill Induktionfähig  
Grill · Grelhador

Ref	€	cm	ØBase (cm)	h (mm)	e (mm)	U.Venta
25162	14,10	14x14	10,0	2,5	1,6	1

## FR

- Fabriqué en fonte d'aluminium de la plus grande qualité.
- Idéale aussi bien pour cuisiner que pour la d'apéritifs ou de plats.
- Finition antiadhésive bi-couche de grande qualité et 100% sans PFOA.
- Sans matériaux toxiques, métaux lourds, dissolvants et substances chimiques.
- Conçue pour une cuisine saine : permet de cuisiner sans à peine utiliser d'huile et avec la garantie que les aliments ne collent pas.
- Distribution homogène de la chaleur, ce qui permet une cuisson rapide et uniforme.
- Apte pour tous types de feux : gaz, électricité, vitroceramique, four et induction.
- Couvercle fabriqué en verre trempé avec valve à vapeur.
- Poignée en bakélite avec finition Soft Touch.
- Manche ergonomique avec finition Soft Touch.

## EN

- Made from a single piece of top quality cast aluminium.
- It's perfect for both cooking and presenting appetisers or dishes.
- It has a high quality bi-layer non-stick coating that is 100% PFOA free.
- It's free of toxic materials, heavy metals, solvents and chemical substances.
- It's designed for healthy cooking. It lets you cook with practically no oil and be sure that food won't stick.
- Food is cooked quickly and evenly because of the homogeneous heat distribution.
- It's suitable for all kinds of cookers: gas, electric, vitroceramic, oven and induction.
- The lid is made of tempered glass with a steam valve.
- Bakelite handle with a Soft Touch finish.
- Ergonomic handle with a Soft Touch finish.



### Cazo recto

Casserole · Stielkasserole, flach  
Saucepan · Caçarola direita

Ref	€	Ø (cm)	ØBase (cm)	h (mm)	e (mm)	L	U.Venta
25164	16,20	14	10,0	8,0	1,6	1,0	1



### Sartén

Poêle · Pfanne  
Frying pan · Sertã

Ref	€	Ø (cm)	ØBase (cm)	h (mm)	e (mm)	U.Venta
25163	12,80	14	10,0	3,0	1,6	1



# COCOTTES Colección



HINWEIS: In Deutschland nicht verfügbar

## ES

- Fabricadas en aluminio fundido.
- Diseño atractivo y funcional.
- Garantizan la absorción y distribución uniforme del calor, sin puntos de sobrecalentamiento.
- La distribución del calor uniforme por toda la pieza hace que los alimentos no pierdan su jugo durante la cocción, conservando así todos sus nutrientes y vitaminas.
- Las puntas situadas bajo la tapa, hacen que las gotas fruto de la condensación, vuelvan a caer sobre los alimentos formando un flujo circulante y permanente reduciendo la pérdida de sabores y jugos de los alimentos.
- Es la pieza perfecta para: arroces, carnes, pescados, legumbres, verduras, guisos, cremas, salsas, sopas, etc.
- Revestimiento antiadherente ILAG:ULTIMATE.

## FR

- Fabriquée en fonte d'aluminium.
- Style attractif et grande fonctionnalité.
- Garantit l'absorption et la distribution uniforme de la chaleur, sans points de surchauffe.
- La distribution de la chaleur uniforme sur toute la pièce permet aux aliments de ne pas perdre leur jus pendant la cuisson, conservant ainsi tous leurs nutriments et vitamines.
- Les pointes situées sous le couvercle permettent aux gouttes issues de la condensation de retomber sur les aliments, formant ainsi un flux permanent de circulation qui réduit la perte des saveurs et des jus des aliments.
- C'est la pièce parfaite pour : riz, viandes, poissons, légumes, ragoûts, crèmes, sauces, soupes, etc.
- Revêtement antiadhésif ILAG: ULTIMATE.

## EN

- Made in cast aluminium.
- Attractive design and great functionality.
- It guarantees the absorption and uniform distribution of heat, without overheating points.
- The uniform distribution of heat throughout the product makes keep its juices during cooking, preserving all its nutrients and vitamins.
- The points located under the lid cause the condensation drops to fall back onto the food, forming a permanent and circulating flow and reducing the loss of the food's flavours and juices.
- This is an ideal product for: rice, meats, fish, beans, vegetables, stews, creams, sauces, soups, etc.
- Non-stick coating ILAG: ULTIMATE.



### Cacerola con tapa MINI

Faitout avec couvercle "MINI" · "MINI" Bratentopf mit Deckel  
"MINI" round casserole with lid · Caçarola com tampa "MINI"

	Ref	€	Ø (cm)	h (cm)	L	U.Venta
	25909	22,50	10	5,0	0,24	12
A	25914	33,00	14	7,5	0,90	1
	25910	22,50	10	5,0	0,24	1
B	25915	33,00	14	7,5	0,90	1



### Cacerola oval con tapa MINI

Faitout Ovale avec couvercle "MINI" · "MINI" Oval Bratentopf mit Deckel  
"MINI" oval round casserole with lid · Caçarola oval com tampa "MINI"

	Ref	€	cm	h (cm)	L	U.Venta
	25911	23,70	12x8,5	5,0	0,25	1
B	25912	22,40	12x8,5	5,0	0,25	1



### ES

- Construida en una sola pieza.
- Recubierta con una capa de aceite vegetal.
- Ideal para cocinar, prolonga suavemente la cocción.
- Gran conductor del calor, mantiene el calor mientras disfrutas y saboreas la comida.
- Base de madera para servir y presentar la comida recién cocinada.

### FR

- Construite en une seule pièce.
- Revêtu d'une couche d'huile végétale.
- Idéal pour cuisiner, prolonge délicatement la cuisson.
- Grand conducteur de chaleur, maintient le plat au chaud pendant que vous dégustez la nourriture.
- Base en bois pour servir et présenter le plat fraîchement cuisiné.

### EN

- Built in one piece.
- Coated with a layer of vegetable oil.
- Ideal for cooking; gently continues to cook.
- Great heat conductor; retains heat while you enjoy and savour the food.
- Wooden base to serve and present freshly cooked food.



#### Cacerola

Faitout · Bratentopf  
Casserola · Caçarola

Ref	€	Ø (cm)	ml	U.Venta
25771	10,70	12,5	230	4
25772	15,60	16,2	470	4
25773	18,80	18,5	720	1



#### Cacerola con base

Faitout avec basse · Bratentopf mit Holzsockel  
Casserola with base · Caçarola com base

Ref	€	Ø (cm)	ml	U.Venta
25871	15,40	12,5	230	4
25872	21,00	16,2	470	1
25873	27,00	18,5	720	1



#### Cacerola oval

Faitout ovale · Oval Bratentopf  
Oval casserola · Caçarola oval

Ref	€	cm	ml	U.Venta
25781	12,10	15x10	200	4
25782	19,00	17,5x12,5	300	1
25783	21,60	21,7x15	700	1



#### Cacerola oval con base

Faitout ovale avec basse · Oval Bratentopf mit Holzsockel  
Oval casserola with base · Caçarola oval com base

Ref	€	cm	ml	U.Venta
25881	15,60	15x10	200	4
25882	24,00	17,5x12,5	300	1
25883	26,70	21,7x15	700	1



#### Mini plancha grill lisa rectangular

Mini plaque grill lisse rectangulaire · Mini Platte Grill, glatt, rechteckiger  
Mini rectangular grill plaque flat · Mini plancha grill liso rectangular

Ref	€	cm	h (cm)	U.Venta
25774	10,20	17x10	2,5	4



#### Mini plancha grill lisa rectangular con base

Mini plaque Grill lisse rectang. a/basse · Mini Platte Grill, glatt, rechteckiger m/Holzsockel  
Mini rectangular grill plaque flat with base · Mini plancha grill liso rectangular c/base

Ref	€	cm	h (cm)	U.Venta
25874	15,00	17x10	2,5	4



#### Mini plancha grill cuadrado

Mini plaque grill carré · Mini Platte Grill, Quadrat  
Mini square grill plaque · Mini plancha grill cuadrado

Ref	€	cm	h (cm)	U.Venta
25775	10,70	14x14	1,7	4



#### Mini plancha grill cuadrado con base

Mini plaque grill carré ave basse · Mini Platte Grill, Quadrat mit Holzsockel  
Mini square grill plaque with base · Mini plancha grill cuadrado com base

Ref	€	cm	h (cm)	U.Venta
25875	15,00	14x14	1,7	4



#### Mini grill

Mini grill · Mini Grill  
Mini grill · Mini grill

Ref	€	cm	h (cm)	U.Venta
25776	11,10	14x14	2,5	4



#### Mini grill con base

Mini grill avec basse · Mini Grill mit Holzsockel  
Mini grill with base · Mini grill com base

Ref	€	cm	h (cm)	U.Venta
25876	17,30	14x14	2,5	1



#### Mini sartén lisa

Mini poêle lisse · Mini Pflanne  
Mini frying pan flat · Mini sertã lisa

Ref	€	Ø (cm)	h (cm)	U.Venta
25777	11,20	13	1,7	4



#### Mini sartén lisa c/base

Mini poêle lisse avec basse · Mini Pflanne mit Holzsockel  
Mini frying pan flat with base · Mini sertã lisa com base

Ref	€	Ø (cm)	h (cm)	U.Venta
25877	16,10	13	1,7	1

# MAGMA GREY & RED

## Colección



### ES

- Acabado exterior e interior esmaltado, muy resistente y de gran durabilidad.
- Muy versátil: ideal para cocinar asados, arroces, pasta, cocer a fuego lento e incluso hornear tartas dulces y pan.
- Conserva todos los nutrientes, vitaminas y sabores de los alimentos.
- Excelente retención y distribución uniforme del calor.
- Incluye base de madera, ideal para servir y presentar.
- Apta para todo tipo de fuegos.

### FR

- Finition extérieure et intérieure émaillée. Émail très résistant et d'une grande durabilité.
- Très versatile : idéale pour cuisiner des ragoûts, du riz, des pâtes, cuire à feu doux et même enfourner des gâteaux et du pain.
- Conserve tous les nutriments, les vitamines et les saveurs des aliments.
- Excellente rétention et distribution uniforme de la chaleur.
- Inclut une base en bois, idéale pour servir et présenter.
- Apte pour tous types de feux.

### EN

- Enamel finish inside and outside. Very strong and durable enamel.
- Extremely versatile: perfect for roasts, rice, pasta, low heat cooking and even baking bread or cake.
- Preserves all the nutrients, vitamins and flavours of the food.
- Excellent heat retention and uniform heat distribution.
- Wooden base included, perfect for serving or presentation.
- Appropriate for all kinds of cookers.



### Cacerola redonda

Faitout rond · Rund Bratentopf  
Round casserole · Caçarola redonda

	Ref	€	Ø (cm)	h (cm)	ml	U.Venta
	25841	17,60	12,0	3,0	200	1
<b>A</b>	25848	27,30	16,2	3,0	470	1
	25849	33,90	18,5	3,0	720	1
	25851	17,60	12,0	3,0	200	1
<b>B</b>	25858	27,30	16,2	3,0	470	1
	25859	33,90	18,5	3,0	720	1

### Cacerola oval

Faitout ovale · Oval Bratentopf  
Oval casserole · Caçarola oval

	Ref	€	cm	h (cm)	ml	U.Venta
	25842	23,50	17,5x12,5	3,0	250	1
<b>A</b>	25840	33,80	21,7x15	3,0	700	1
	25852	23,70	17,5x12,5	3,0	250	1
<b>B</b>	25850	34,10	21,7x15	3,0	700	1



### Sartén

Poêle · Pfanne  
Frying pan · Sertã

	Ref	€	Ø (cm)	h (cm)	ml	U.Venta
<b>A</b>	25843	17,70	13,5	3,0	275	1
<b>B</b>	25853	17,70	13,5	3,0	275	1

### Cacerola redonda con tapa

Faitout rond avec couvercle · Rund Bratentopf mit Deckel  
Round casserole with lid · Caçarola redonda com tampa

	Ref	€	Ø (cm)	h (cm)	ml	U.Venta
<b>A</b>	25846	28,50	10	5,0	200	1
<b>B</b>	25856	28,50	10	5,0	200	1



### Cacerola rectangular con tapa

Faitout rectangulaire avec couvercle · Bratentopf, rechteckig mit Deckel  
Rectangular casserole with lid · Caçarola rectangular com tampa

	Ref	€	cm	h (cm)	ml	U.Venta
<b>A</b>	25845	33,40	13x9	4,5	300	1
<b>B</b>	25855	33,40	13x9	4,5	300	1

### Cacerola oval con tapa

Faitout ovale avec couvercle · Oval Bratentopf mit Deckel  
Oval casserole with lid · Caçarola oval com tampa

	Ref	€	cm	h (cm)	ml	U.Venta
<b>A</b>	25847	33,80	13x10	5,0	400	1
<b>B</b>	25857	33,80	13x10	5,0	400	1



# MAGMA

## Colección



ES

- Fabricadas en melamina de alta calidad.
- Libres de BPA.
- Ofrecen un aspecto muy natural parecido al hierro fundido.
- Ideales para servir y presentar los platos más exquisitos.

FR

- Fabriqué en mélamine de haute qualité.
- Sans BPA.
- Aspect très naturel, semblable à la fonte d'aluminium.
- Idéale pour servir et présenter les plats les plus exquis.

EN

- Made of high quality melamine.
- BPA free.
- Very natural appearance similar to cast iron.
- Perfect for serving and presenting the most exquisite dishes.



### Cacerola redonda

Faitout rond · Rund Bratentopf  
Round casserole · Caçarola redonda

Ref	€	Ø (cm)	U.Venta
63384	5,10	16	12
63385	6,20	18	12



### Cacerola oval

Faitout ovale · Oval Bratentopf  
Oval casserole · Caçarola roval

Ref	€	cm	U.Venta
63388	4,50	18x12	12
63389	5,80	21x15	12



### Wok

Wok · Wok  
Wok · Wok

Ref	€	Ø (cm)	U.Venta
63386	4,30	15	12
63387	5,90	18	12



### Mini grill

Mini grill · Mini grill  
Mini grill · Mini grill

Ref	€	cm	U.Venta
63382	7,40	13,5x13,5	6



### Mini sartén

Mini pøele · Mini Pfanne  
Mini frying pan · Mini sertã

Ref	€	Ø (cm)	U.Venta
63381	7,00	15	6



### Mini sartén rectangular

Mini pøele rectangulare · Mini Pfanne, rechteckiger  
Rectangular Mini frying pan · Mini sertã rectangular

Ref	€	cm	U.Venta
63383	5,10	17x11,5	12

# MINI-COCOTTES

## Colección



ES

- Fabricadas en melamina de alta calidad. Libres de BPA.
- Ofrecen un aspecto muy natural parecido al hierro fundido.
- Ideales para servir y presentar los platos más exquisitos.

FR

- Fabriqué en mélamine de haute qualité. Sans BPA.
- Aspect très naturel, semblable à la fonte d'aluminium.
- Idéale pour servir et présenter les plats les plus exquis.

EN

- Made of high quality melamine. BPA free.
- Very natural appearance similar to cast iron.
- Perfect for serving and presenting the most exquisite dishes.

### Cacerola BLACK

Faitout · Bratentopf  
Casserole · Caçarola

	Ref	€	Ø (cm)	h (cm)	ml	U.Venta
A	63390	4,40	9	4,5	150	1
B	63391	11,80	18x8,5	5,0	480	1
C	63392	11,10	10	4,5	210	1
	63393	20,10	14	6,5	640	1

A



B



C



### Cacerola RED

Faitout · Bratentopf  
Casserole · Caçarola

	Ref	€	Ø (cm)	h (cm)	ml	U.Venta
A	63394	4,40	9	4,5	150	1
B	63395	11,80	18x8,5	5,0	480	1
C	63396	11,10	10	4,5	210	1
	63397	20,10	14	6,5	640	1

A



B



C



### Cacerola GREY

Faitout · Bratentopf  
Casserole · Caçarola

	Ref	€	Ø (cm)	h (cm)	ml	U.Venta
A	63398	4,40	9	4,5	150	1
B	63399	11,80	18x8,5	5,0	480	1
C	63400	11,10	10	4,5	210	1
	63401	20,10	14	6,5	640	1

A



B



C



# PRESENTACIÓN

## Colección

Inox



NO VÁLIDOS PARA FREIR  
NOT valid for frying



ES

- Fabricados en acero inoxidable de gran calidad (cestillos y cubos).
- Una forma elegante y original de servir todo tipo de aperitivos y tapas en bares, cafeterías, restaurantes o catering.
- Permiten colocar los alimentos sobre papel absorbente o bien directamente sobre el cestillo.

FR

- Fabriquées en acier inoxydable de la plus grande qualité (paniers et cubes).
- Une façon élégante et originale de servir toutes sortes d'apéritifs et de tapas dans les bars, cafés, restaurants ou traiteurs.
- Permet de déposer les aliments sur du papier absorbant ou directement sur le panier.

EN

- Made of top quality stainless steel (baskets and cubes).
- An elegant and original way of serving all kinds of snacks and tapas in bars, cafes, restaurants or catering.
- Can be presented on absorbent paper or directly on the rack.

New

Reversible  
Reversible



### Soporte para tacos

Support de tacos · Tacos Unterstützung  
Tacos support · Suporte de tacos

	Ref	€	Tacos	cm	h (cm)	U.Venta
A	63281	4,00	1-2	12x6	4	1
B	63282	4,60	2-3	18x6	4	1
C	63283	5,40	3-4	23x6	4	1



- Fabricado en melamina de alta calidad. Libre de BPA.
- Espesor grueso, ligero y muy resistente.
- Ideal para montar y servir los tacos y evitar derrames de rellenos.
- Diseño ondulado: las ranuras en forma de V ayudan a que los tacos se mantengan erguidos.
- Multiusos: para apoyar tacos, sándwiches, burritos, perritos calientes, etc. No se recomienda mantener alimentos cocinados durante más de 24 horas.
- No apto para cocinar, asar, hornear o utilizar en el microondas.
- Apto para lavavajillas.

- Fabriqué en mélamine de grande qualité. Sans BPA.
- Très épais, léger et très résistant.
- Idéal pour faire et servir les tacos et éviter la chute de garnitures.
- Conception ondulée : les rainures en forme de V permettent aux tacos de rester droits.
- Multiusages : pour faire tenir des tacos, sandwichs, burritos, hot dogs, etc. Il n'est pas recommandé de conserver des aliments cuits pendant plus de 24 heures.
- Ne convient pas à la cuisson, au grill, au four ou au micro-ondes.
- Apte pour le lave-vaisselle.

- Made of top quality melamine. BPA free.
- Thick, lightweight and very strong.
- Ideal for making and serving tacos and preventing spillage of fillings.
- Wavy design: V-shaped grooves help keep the tacos upright.
- Multi-purpose: for holding tacos, sandwiches, burritos, hot dogs, etc. Not recommended to storage cooked food over 24 hours.
- Not suitable for cooking, grilling or baking. Not for microwave use.
- Dishwasher safe.



### Cestillo redondo

Panier rond · Korb, Rund  
Round basket · Cesta redonda

	Ref	€	Ø (cm)	h (cm)	U.Venta
A	61009	8,70	9	8,0	6 INOX
B	61069	8,70	9	8,0	6 BRONCE
C	61150	8,50	9	8,0	6 BLACK



### Cestillo cuadrado

Panier carré · Korb, quadratisch  
Square basket · Cesta quadrada

	Ref	€	cm	h (cm)	U.Venta
A	61007	8,70	10x8	7,0	6 INOX
	61052	11,20	12x10	9,0	6
B	61067	8,70	10x8	7,0	6 BRONCE
	61062	11,20	12x10	9,0	6
C	61151	8,50	10x8	7,0	6 BLACK
	61152	10,90	12x10	9,0	6



### Cestillo rectangular

Panier rectangulaire · Korb, rechteckig  
Rectangular basket · Cesta rectangular

	Ref	€	cm	h (cm)	U.Venta
A	61056	13,00	21x11	6,0	1 INOX
B	61066	13,00	21x11	6,0	1 BRONCE
C	61155	12,60	21x11	6,0	1 BLACK



### Mini cubo

Mini-cube · Mini-Eimer  
Mini cube · Mini cubo

	Ref	€	Ø (cm)	h (cm)	ml	U.Venta
A	61107	4,80	7	7,0	200	12
B	61109	5,70	9	9,0	340	1
C	61112	7,40	12	12,0	900	1



### Cestillo cónico

Panier conique · Korb, Konisch  
Conical basket · Cesta cónica

	Ref	€	Ø (cm)	h (cm)	U.Venta
A	61053	9,60	12	10,0	6 INOX
B	61063	9,60	12	10,0	6 BRONCE
C	61153	9,30	12	10,0	6 BLACK



### Cestillo rectangular con asas

Panier rectangulaire a/poignées · Korb, rechteckig mit Griffen  
Rectangular basket with handles · Cesta rectangular com alças

	Ref	€	cm	h (cm)	U.Venta
A	61055	13,00	21x11	6,0	1 INOX
B	61065	13,00	21x11	6,0	1 BRONCE
C	61154	12,60	21x11	6,0	1 BLACK



### Mini palet presentación

Mini palette de présentation · Minipalette für Präsentation  
Mini pallet for presentation · Mini palette de apresentação

	Ref	€	cm	h (cm)	U.Venta
	61060	6,50	13x8	3,0	1
	61059	8,70	20x12	3,0	1
	61058	11,60	30x20	3,0	1
	61057	13,30	40x15	3,0	1



### Colección SMALT

Collection · Kollektion  
Collection · Coleção

	Ref	€	Ø (cm)	U.Venta
	60170	5,10	10	10
	60172	5,70	12	10
A	60175	6,70	15	6
	60180	8,60	20	6
	60192	6,50	12	6
B	60196	7,70	16	6
	60190	8,50	20	6

Esmalte vitrificado  
Vitrified enamel

Paellera  
Round dish

Cacerola  
Casserole

# BANDEJAS · TABLAS

## Colección



### New



Basic

Drop

Bambú Zensai

- Bandeja de bambú con 3/5 cuencos de porcelana para servir pequeñas porciones. Perfecta para cualquier evento o reunión.
- Tabla de bambú con hendiduras a medida para los cuencos.
- Capacidad de un cuenco: 100 ml (61240) / 90 ml (61241).
- Ideal para aperitivos, condimentos y salsas, frutos secos, semillas, mermeladas, etc.
- Combina de forma muy elegante el bambú y la porcelana, dándole un aspecto moderno.
- Cuencos aptos para el lavavajillas, el microondas y horno.

- Plateau en bambou avec 3/5 bols en porcelaine pour servir de petites portions. Parfait pour tous types événement ou de réunions.
- Plateau en bambou avec fentes sur mesure pour les bols.
- Capacité d'un bol: 100 ml (61240) / 90 ml (61241).
- Idéal pour les apéritifs, les condiments et les sauces, les fruits secs, les graines, les confitures, etc.
- Combine très élégamment le bambou et la porcelaine, en apportant un aspect moderne.
- Bols aptes pour le lave-vaisselle, le micro-ondes et le four.

- Bamboo tray with 3/5 porcelain bowls for serving small portions. Perfect for any event or gathering.
- Bamboo board with special recesses for the bowls to sit in.
- Bowl size: 100 ml (61240) / 90 ml (61241)
- Ideal for snacks, dressings, dips, sauces, nuts, seeds, jam, etc.
- The perfect combination of bamboo and porcelain for that stylish contemporary look.
- Dishwasher, microwave and oven safe bowls.

#### Bandeja con cuencos

Plateau avec bols · Tablett mit Schüsseln  
Tray with bowls · Bandeja com taças

Ref	€	Base (cm)	Cuencos	ml	U.Venta
61240	7,30	28x10x1	8,5x8,5x3	100 (x3)	1
61241	7,30	28x10x1	9,5x8,5x3	90 (x3)	1
61243	21,70	Ø26x1	3,5	-	1

### New



#### Fuente 5 compartimentos ZENSAI

Plat 5 compartiments · Platte mit 5 Fächern  
5-compartment tray · Travessa com 5 compartimentos

Ref	€	Ø (cm)	h (cm)	Compar.	U.Venta
61242	9,40	25,5	4,0	5	1

- Bandeja fabricada en porcelana de gran calidad.
- Dispone de 5 compartimentos diseñados para servir y presentar aperitivos, snacks, salsas, etc.
- Robusto y duradero.
- Apta para el horno, microondas y lavavajillas.

- Plateau fabriqué en porcelaine de grande qualité.
- Dispose de 5 compartiments conçus pour servir et présenter des apéritifs, snacks, sauces, etc.
- Robuste et durable.
- Apte pour le four, le micro-ondes et le lave-vaisselle.

- High-quality porcelain tray.
- Features 5 compartments designed to serve and present appetisers, snacks, sauces, etc.
- Robust and long-lasting.
- Oven, microwave and dishwasher safe.

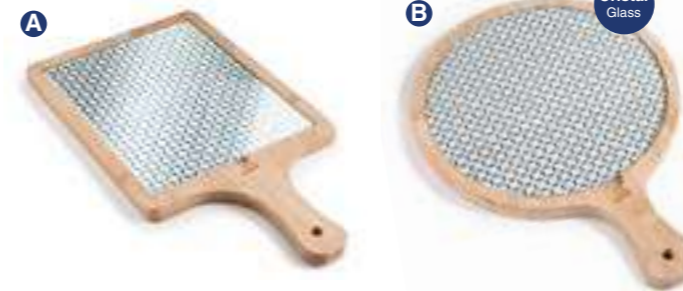

#### Tabla cristal & bambú

Planche verre & bambou · Glas & bambusbrett  
Glass & bamboo board · Tábua vidro & bambu

Ref	€	Tabla con mango (cm)	Cristal (cm)	U.Venta
61048	12,60	38,5x21,5x1,5	28x18,5	1
61049	13,10	38,5x27,5x1,5	Ø24,5	1



#### Tabla pizarra & bambú

Planche ardoise & bambou · Schiefer & bambusbrett  
Slate & bamboo board · Tábua ardósia & bambu

Ref	€	Tabla con mango (cm)	Pizarra (cm)	U.Venta
61045	7,30	40x10x1,5	25x7,5	1
61046	14,60	50x18x1,5	35x15	1
61047	19,70	38,5x28x1,5	Ø25	1



#### Tabla pizarra & bambú

Planche ardoise & bambou · Schiefer & bambusbrett  
Slate & bamboo board · Tábua ardósia & bambu

Ref	€	Tabla (cm)	Pizarra (cm)	Cuenco (cm)	ml	U.Venta
61042	18,40	28x28x1,5	25x15	8,5x8,5x3	56	1

### New



#### Tabla marmol & bambú

Planche marbre & bambou · Marmor & bambusbrett  
Marble & bamboo board · Tábua mármore & bambu

Ref	€	Tabla (cm)	Mármol (cm)	Cuenco (cm)	ml	U.Venta
61040	18,20	28x28x1,5	24,5x15x1	Ø8x3	100 (x3)	1

- Tabla de bambú natural con una base extraíble de mármol blanco de gran calidad de 24,5x15 cm y grosor de 1,0 cm.
- Resistente, robusto y duradero.
- Higiénica; gracias a las propiedades antibacterianas del mármol se limpia fácilmente.
- Diseñado para presentar y servir todo tipo de platos y aperitivos.
- Incluye 3 cuencos de porcelana para salsas o snacks.
- Diseño atractivo y elegante.
- Fácil limpieza: se recomienda lavar a mano.

- Natural bamboo serving board featuring a high quality removable white marble 24,5x15 cm base with 1,0 cm thickness.
- Resistant, robust and long-lasting.
- Hygienic: the antibacterial properties of marble make it easy to clean.
- Designed to present and serve all kind of dishes and snacks.
- Includes 3 porcelain bowls for sauces or snacks.
- Attractive, stylish design.
- Easy to clean. Washing by hand is recommended.

# ALIÑO

## Colección



**Juego vinagrera BASIC**  
Set vinaigrie · Menage  
Cruet set · Jogo galheteiro

Ref	€	ml	U.Venta
62864	13,90	175-37,5	1



**Juego aceitera-vinagrera BASIC**  
Set huilier et vinaigries · Öl-Essig-Set  
Oil-vinegar set · Jogo azeiteira-galheteiro

Ref	€	ml	U.Venta
62862	11,10	175	1



**Juego salero-pimentero BASIC**  
Set calière et poiviere · Satz-Pfeffer-Set  
Salt-pepper set · Jogo saleiro-pimenteiro

Ref	€	ml	U.Venta
62866	5,70	37,5	6



**Jgo. salero-pimentero-mostaza BASIC**  
Set 3 pièces sel poivre moutarde · Salz/Pfeffer/Senf-Set  
Salt-pepper-mustard set · Saleiro-pimenteiro-mostarda set

Ref	€	ml	U.Venta
62867	9,20	37,5-150	1



**Aceitera cónica**  
Huilier · Ölkanne  
Oil can · Azeiteira cónica

Ref	€	L	h (cm)	U.Venta
62525	28,00	0,25	10,0	1
62555	41,10	0,50	19,0	1
62551	50,50	1,00	23,0	1



**Dosificador-medidor de aceite**  
Doseur distributeur à huile · Öl-Dosierer mit Massanzeige  
Oil portionner-measurer · Distribuidor-manómetro de óleo

Ref	€	Ø (cm)	ml	U.Venta
62252	22,10	7,8x23	250	1



**Pulverizador de aceite**  
Pulvérisateur d'huile · Öl-Spray  
Oil Sprayer · Pulverizador de azeite

Ref	€	Ø (cm)	ml	U.Venta
61908	15,40	7x18	100	1



**Pulverizador de aceite-vinagre**  
Pulvérisateur d'huile et vinaigries · Öl-Essig Spray  
Oil-vinager bottle spray · Pulverizador de azeite-galheteiro

Ref	€	Ø (cm)	ml	U.Venta
61921	16,10	5,5x20	200	1



**Jarra separadora grasas**  
Separateur de graisse · Fettabscheider  
Gravy/fat separator · Separador de gorduras

Ref	€	ml	Unidades	U.Venta
61610	7,10	500	ml-oz-cup	4

# ESPECIEROS

## Colección



**Agujeros pequeños**  
Small holes



**Especeiro agujeros**  
Saupoudreuse à figures · Gewürzdose/Streuer, Lochung  
Shaker plastic cover hole lid · Polvilhador burucos

Ref	€	Ø (cm)	h (cm)	U.Venta
A 62906	8,70	7	9,50	12
B 62905	8,70	7	9,50	12

**Agujeros grandes**  
Big holes



**Especeiro queso rayado**  
Saupoudreuse à fromage · Käsestreuer  
Cheese shaker · Polvilhadoqueijo ralado

Ref	€	Ø (cm)	h (cm)	U.Venta
62904	8,50	7	9,50	12



**Especeiro malla fina**  
Saupoudreuse à maille · Gewürzdose/Streuer-Fein  
Shaker plastic cover fine mesh lid · Polvilhador rede fina

Ref	€	Ø (cm)	h (cm)	U.Venta
62903	9,20	7	9,50	12



**Pimentero**  
Poivrière · Pfefferstreuer  
Pepper shaker · Pimenteiro

Ref	€	Ø (cm)	h (cm)	U.Venta
61903	10,60	7	12,5	1



**Especeiro queso rayado**  
Saupoudreuse à fromage · Käsestreuer  
Cheese shaker · Polvilhadoqueijo ralado

Ref	€	Ø (cm)	h (cm)	U.Venta
61905	10,60	7	12,5	1



**Salero**  
Salière · Salzstreuer  
Salt shaker · Saleiro

Ref	€	Ø (cm)	h (cm)	U.Venta
61907	10,70	7	12,5	1



**Azucarero**  
Saupoudreuse à sucre · Zuckerstreuer  
Sugar shaker · Acucareiro

Ref	€	Ø (cm)	h (cm)	U.Venta
61904	12,00	7	12,5	1



**Especeiro malla**  
Saupoudreuse à maille fine · Mehlstreuer  
Mesh shaker · Polvilhador rede

Ref	€	Ø (cm)	h (cm)	U.Venta
61906	11,30	7	12,5	1



**Dispensador miel**  
Distributeur de miel · Honigbehälter  
Honey dispenser · Dosificador mel

Ref	€	Ø (cm)	h (cm)	U.Venta
61909	14,00	7	12,5	1



# MOLINILLOS

## Colección



### ES

- Muele al instante. Muelas: no pierden filo y no se oxidan.
- Molido a baja velocidad: conserva mejor las propiedades y aromas.
- Funcionamiento sencillo. Muy fácil de limpiar.

### FR

- Moud à l'instant. Meules : pas d'usure du fil et pas d'oxydation.
- Mouture à faible vitesse : meilleure conservation des propriétés et des arômes.
- Fonctionnement simple. Très facile à nettoyer.

### EN

- Grinds instantly. Burrs don't get dull or rusty.
- Low speed grind conserves coffee properties and aromas better.
- Easy to use. Very easy to clean.

Mecanismo de acero templado  
Hardened steel mechanism



### Molinillo de pimienta

Moulin à Poivre · Pfeffermühle  
Pepper Grinder · Moinho de pimenta em madeira

Ref	€	Ø (cm)	h (cm)	U.Venta
63215	26,70	5,0	15	1
63220	31,30	5,5	20	1
63225	37,20	6,0	25	1

Mecanismo cerámico  
Ceramic mechanism



### Molinillo de sal - pimienta

Moulin à sel - poivre · Pfeffer / Salzmillie  
Salt - pepper Grinder · Moinho de sal - pimenta

Ref	€	h (cm)	U.Venta
62814	23,50	14	6
62818	24,40	18	6
62823	26,40	23	6

Mecanismo cerámico  
Ceramic mechanism



### Molinillo doble sal - pimienta

Moulin double à sel - poivre · Salz und Pfeffermühler Doppelt  
Salt - pepper double grinder · Moinho duplo de sal - pimenta

Ref	€	Ø (cm)	h (cm)	g	U.Venta
62816	19,50	6	18	90	1

Mecanismo cerámico  
Ceramic mechanism

8 niveles de grosor  
8 grinding levels



Inox  
18/10

Cristal  
Glass

### Molinillo manual

Moulin manuel · Manuelle Mühle  
Manual grinder · Moinho manual

Ref	€	g	h (cm)	U.Venta
62817	33,20	45	21	1

Ideal para moler café, semillas, frutos secos, etc. Cuchillas de acero inoxidable de gran resistencia. Depósito para 60 g de granos de café molido. Perfect for grinding coffee, seeds, nuts, etc. High strength st. steel blades. Container for 60 g of ground coffee



### Molinillo LIMU

Moulin électrique · Elektrische Mühle  
Electric grinder · Moinho elétrico

Ref	€	U.Venta
69385	37,20	1

Ref	Tensión/Voltage	Potencia/Power	Capacidad/Capacity	Dimensiones/Sizes	Peso/Weight
69385	220-240 V ; 50/60 Hz	200 W	60 g (9 cups)	Ø10x18 cm	0,780 Kg

Mecanismo cerámico  
Ceramic mechanism

Pulsadores independientes  
Independent switch



6 pilas de 1,5 V AAA  
(NO incluidas)  
6 x 1.5V AAA batteries  
(Not included)

### Molinillo DUAL eléctrico sal - pimienta

Moulin DUAL électrique à sel - poivre · Elektrische Satz-/Pfeffermühle, DUAL  
DUAL salt - pepper electric grinder · Moinho DUAL eléctrico sal - pimenta

Ref	€	Ø (cm)	h (cm)	U.Venta
62824	21,30	7	18	1

### Inox

- Ideal para moler café y otros productos como semillas, hierbas, frutos secos, cereales, sal, pimienta o especias.
- 100% acero inoxidable: cuerpo y cuchillas fabricados en acero inoxidable de máxima calidad.
- Tapa transparente: tapa superior de color transparente para visualizar el grano molido.
- Interruptor ON/OFF: funcionamiento con un simple botón (inicio/parada).
- Interruptor de seguridad: las cuchillas se activan solo cuando la tapa está correctamente cerrada.
- Depósito para 60 g de granos de café molido.
- Almacenamiento para el cable.
- Libre de BPA.

- Idéal pour mouler le café et d'autres produits tels que les graines, les herbes, les fruits secs, les céréales, le sel, le poivre ou les épices.
- 100% acier inoxydable : Corps et lames fabriqués en acier inoxydable de la plus grande qualité.
- Couvercle transparent : Couvercle supérieur de couleur transparente pour visualiser le grain moulu.
- Interrupteur ON/OFF : Fonctionnement avec un simple bouton (marche/arrêt).
- Interrupteur de sécurité : Les lames se mettent en marche uniquement lorsque le couvercle est correctement fermé.
- Réservoir pour 60 g de grains de café moulu.
- Rangement pour le câble.
- Sans bisphénol A.

- Perfect for grinding coffee or other products like seeds, herbs, nuts, grains, salt, pepper or spices.
- 100% Stainless Steel: Body and blades made of top quality stainless steel.
- Transparent Lid: Transparent upper lid so you can see the ground product.
- ON/OFF Button: Works with a simple button (start/stop).
- Safety Switch: The blades are only activated when the lid is properly closed.
- Container for 60 g of ground coffee.
- Storage for the cord.
- BPA Free.

# MESA Servicio

Inox 18/10 Dishwasher



## Legumbre

Legumiere · Servierschüssel  
Vegetable dish · Legumeira

Ref	€	Ø (cm)	L	U.Venta
60812	24,80	22	2,0	1
60814	27,80	24	3,0	1
60818	36,60	28	4,5	1



## Sopera con base

Soupiere sur pied · Suppenschüssel mit Fussreif  
Soup-tureen with base · Sopeira com base

Ref	€	Ø (cm)	L	U.Venta
60823	31,90	22	2,00	1
60825	34,10	24	2,50	1
60829	42,00	28	4,00	1



## Tapa sobpera

Couvercle soupiere · Deckel für Servierschüssel  
Soup-tureen lid · Tampa sopeira

Ref	€	Ø (cm)	U.Venta
60922	20,20	22	1
60924	22,40	24	1
60928	26,30	28	1



Área útil de la base:  
Base useful area:  
15x10,5 cm

## Recipiente de mantequilla

Réceptacle pour le beurre · Butterdose  
Butter container · Recipiente para manteiga

Ref	€	cm	h (cm)	U.Venta
62898	9,80	18,5x14	6,5	1



## Recipiente de mantequilla

Réceptacle pour le beurre · Butterdose  
Butter container · Recipiente para manteiga

Ref	€	cm	h (cm)	U.Venta
62899	15,00	16,5x11,5	6,5	1

- Mantiene la mantequilla fresca durante más tiempo preservando las propiedades, aroma y color.
  - Ideal para servir directamente la mantequilla en la mesa.
  - Multifuncional, ideal para mantequilla, pastas, galletas, frutos secos, etc.
- Maintient le beurre frais plus longtemps en préservant ses propriétés, son odeur et sa couleur.
- Idéal pour servir directement le beurre à table.
  - Multifonctionnel, idéal pour le beurre, les biscuits, les fruits secs, etc.
- It keeps butter fresh longer and preserve its aroma and colour.
- It's perfect for serving butter on the table.
  - Multifunctional, ideal for butter, pasta, cookies, nuts, etc.



## Ensaladera redonda

Saladier ronde · Salatschüssel, rund  
Round salad bowl · Bacia de salada redonda

Ref	€	Ø (cm)	L	U.Venta
62394	12,40	25	4,0	1

garinox®



## 6 boles pequeños

6 petit bols · 6 Schüsseln, klein  
Vegetable bowls set of 6 · 6 bacias pequenas

Ref	€	Ø (cm)	ml	U.Venta
14012	11,30	12	325	1



## Salsera LUXE con cuchara

Sauciere "Luxe" · Sauciere Luxe  
Gravy boat "Luxe" · Molheira "LUXE" com colher

Ref	€	ml	U.Venta
62424	23,70	200	1



## Campana cubreplatos

Cloche couvre plat · Tellerlocke  
Plate Cover · Campânula cobre-pratos

Ref	€	Ø (cm)	h (cm)	Total (cm)	U.Venta
61806	39,40	25	14,0	18,5	1
61809	45,10	29	15,0	20,3	1
61802	48,80	33	17,0	22,3	1
69024	25,60	24	-	11,0	1
69029	38,40	28	-	17,5	1

- Resistentes a golpes, altas y bajas temperaturas (61806-9-2).
- Protege los alimentos de los factores externos.
- Ideales tanto para conservar como para presentar galletas, bollería, quesos y todo tipo de alimentos.
- Resistente a golpes, altas y bajas temperaturas (61806-9-2).
- Se puede introducir en el microondas, horno y congelador (61806-9-2).

- Protège les aliments des agents externes.
- Idéales aussi bien pour conserver que pour présenter des gâteaux, des viennoiseries, des fromages et tout type d'aliments.
  - Résistante aux chocs ainsi qu'aux basses et hautes températures (61806-9-2).
  - Peut être mise au micro-ondes, au four ou au congélateur (61806-9-2).
- Protects food from external factors.
- Perfect for preserving and presenting biscuits, pastries, cheese or any other kind of food.
  - Shock, high and low temperature resistant (61806-9-2).
  - Microwave, oven and freezer safe (61806-9-2).



## Salsera ALADINO

Sauciere "Aladino" · Sauciere "Aladino"  
Gravy boat "Aladino" · Molheira "Aladino"

Ref	€	cm	ml	U.Venta
61409	9,50	13x6x8	90	1
61415	11,40	15,5x7,2x10	150	1
61424	15,40	19x8,5x12,5	240	1
61430	16,50	20x9,5x12,5	300	1



## Quesera parmesana con cuchara

Boite à fromage a/cuillère · Parmesanmenage mit Löffel  
Parmesan bowl with spoon · Queijeira parmesana c/ colher

Ref	€	Ø (cm)	ml	U.Venta
62970	31,30	9x5	200	1
* 62971	4,10		200	18

\* Recipiente de cristal · Glass container



## Fuente de mantequilla

Beurrer avec couvercle · Butterdose mit Deckel  
Butter dish with cover · Manteigueira

Ref	€	cm	h (cm)	U.Venta
62951	14,00	11,5x22,5	6,5	1



## Cubre quesos / tartas

Couvre fromage/gâteau · Tellerabdeckung  
Cheese/cake cover · Cloque para queijo/tartes

Ref	€	Ø (cm)	U.Venta
62380	53,60	32	1



## Quesera

Plateau à fromage avec cloche · Käseglocke  
Cheese dome · Queijeira

Ref	€	U.Venta
62404	29,00	1



## Azucarero sobremesa

Sucrier de table sphérique · Zuckerdose, Kugelförmig  
Spherical table sugar bowl · Açucareiro de mesa esférico

Ref	€	Ø (cm)	ml	U.Venta
63304	16,90	14	600	1



### Soporte menú con pinza

Support menu á pince · Menükartenhalter  
Menu card holder · Suporte menú com pinça

Ref	€	h (cm)	U.Venta
61008	12,90	20,0	1
61012	14,40	30,0	1



### Servilletero

Distributeur de serviettes · Serviettenspender  
Napkin holder · Guardanapo

Ref	€	cm	h (cm)	U.Venta
61004	13,50	18x19	5,0	1



### Cepillo recogemigas

Ramasse-miettes á rouleaux · Krümelbürste  
Crumbs cleaner · Escova apanha-migalhas

Ref	€	cm	h (cm)	U.Venta
64407	14,70	9,5x16,5	4,0	1



### Pinza sujeta manteles (4 pcs.)

Pince á nappe · Tischtuchklammer  
Tablecloths pegs · Pinça para toalhas de mesa

Ref	€	U.Venta
61023	6,90	6



### Indicador reservado

Indicateur résevée · Reserviert-Aufsteller  
Reserved signal · Indicador reservado

Ref	€	cm	U.Venta
61098	4,30	5x12	6



### Servilletero bar

Distributeur de serviettes bar · Serviettenspender bar  
Bar napkin holder · Guardanapo bar

Ref	€	cm	Servilleta	U.Venta
61001	13,20	8,5x12,0	90x125	1
61002	9,40	9,5x13,5	90x125	4



### Cepillo recogedor HIPERLUXE

Ramasse-miettes á rouleaux · Krümelbürste  
Crumbs cleaner · Escova apanha-migalhas

Ref	€	cm	U.Venta
64408	49,70	14,5x17	1



### Números de mesa

Numéros de table · Tischnummernschild  
Table numbers · Números para tabela

Ref	€	cm	Números	U.Venta
61095	20,00	6x5	1-12	1
61096	20,00	6x5	13-24	1
61097	19,90	6x5	25-36	1



### Campanilla de recepción

Sonnette de réception · Rezeptionsklingel  
Reception call bell · Campainha de receção

Ref	€	Ø (cm)	U.Venta
61025	11,30	10	1



### Papelera sobremesa

Poubelle de table · Tish-Abfallbehälter  
Table bin · Papeleira de mesa

Ref	€	Ø (cm)	L	U.Venta
63302	24,10	12x16	1,20	1

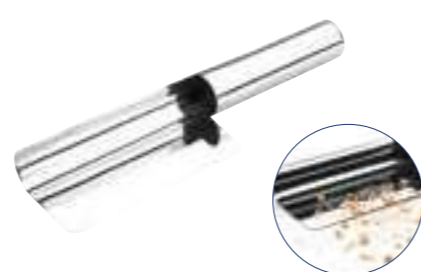

### Cepillo recogedor LUXE

Ramasse-miettes · Krümelbürste  
Crumbs cleaner · Espátula apanha-migalhas

Ref	€	cm	U.Venta
64409	30,90	22x7	1



### Bandeja con pinza para notas

Porte addition á pince · Platte mit Klemmvorrichtung  
Bill holder · Bandeja com pinça para notas

Ref	€	cm	U.Venta
68007	5,30	11x15,2	12
68017	6,20	12x21,5	12



### Bandeja cambios COIN

Coupelle ramasse monnaie · Wechselgeldablagen  
Changetray · Bandeja para trocos

Ref	€	Ø (cm)	U.Venta
68720	3,10	13	12



### Cenicero

Cendrier · Aschenbecher  
Ashtray · Cinzeiro

Ref	€	Ø (cm)	U.Venta
14013	2,70	14	12
14065	3,10	16	12
62941	6,20	14	1

## ENCENDEDORES Colección



ES

- Encendido con gatillo.
- Regulador de llama.
- Recargable.
- Sistema de bloque de seguridad.

FR

- Allumage avec gâchette.
- Régulateur de flamme.
- Rechargeable.
- Système de sécurité par blocage.

EN

- Trigger lighter.
- Flame regulator.
- Rechargeable.
- Safety lock system.



### Encendedor de gas

Allume-gaz á flamme · Gasanzünder  
Gas lighter · Isqueiro de gás

Ref	€	L (cm)	U.Venta
68987	4,00	27	6
68978	3,50	27	12
68979	4,30	27	12
68976	36,80	-	1
68977	47,20	-	1

# COMBUSTIBLE

## Gel

### ES

- Gel de origen orgánico.
- No produce emanaciones tóxicas.
- Encendido rápido y combustión silenciosa, limpia, inodora, sin humos y sin cenizas.

### FR

- Gel d'origine biologique.
- Ne produit pas de fumées toxiques.
- Allumage rapide et combustion silencieuse, propre, sans odeur, sans fumée et sans cendres.

### EN

- Organic gel fuel.
- Does not produce toxic fumes.
- Quick-lighting and quiet-burning, clean, odourless, smokeless and ash-free.



#### Contenedor de combustible

Porte-brûleur · Brennpasten-Behälter  
Burner holder · Recipiente de combustível

Ref	€	Ø (cm)	h (cm)	L (cm)	Asa	U.Venta
69006	23,90	9,0	6,0	7,0		1



#### Gel combustible ETANOL

Gel chauffe ETHANOL · Brennpaste, ETHALKOHOL  
Fuel gel, ETHANOL · Gel combustível ETANOL

Ref	€	Kg	Horas	U.Venta	
<b>A</b> 71780	4,80	0,08	80 min	1	<b>Set 3 latas</b> · 3 can set
<b>B</b> 69108	2,70	0,225	3	72	<b>Lata</b> · Can
<b>C</b> 69107	8,60	0,840	-	1	<b>Botella</b> · Bottle
<b>D</b> 69109	39,40	4,00	-	1	<b>Bidón</b> · Barrel

Pinzas  
Tonge

# PINZAS

## Colección

Inox  
18/10



### Pinza servicio mesa

Pince à servir · Servierzange  
Serving tong · Pinça de serviço de mesa

Ref	€	L (cm)	U.Venta
62307	4,80	21	12



### Tenedor - cuchara servir

Pince à service · Servierzange  
Utility tong · Garfo e colher de servir

Ref	€	L (cm)	U.Venta
68009	9,90	24	6



### Cuchara pinza servir

Cuillère pince à service · Servierlöffel, Zange  
Serving spoon tong · Concha pinça de servir

Ref	€	L (cm)	U.Venta
62353	12,20	24	1



### Pinza hamburguesa

Pince inox pour hamburger · Zange für Burgers  
Tongs for beef Burgers · Pinça de hamburger

Ref	€	L (cm)	U.Venta
62318	11,90	24	12



### Pinza pasta LUXE

Pince à spaghetti · Teigwaren-Zange  
Pasta Tong · Pinça massas

Ref	€	L (cm)	U.Venta
62981	10,10	20	1



### Pinza pasta

Pince à spaghetti · Teigwaren-Zange  
Spaguetti Tong · Pinça massas

Ref	€	L (cm)	U.Venta
62986	5,40	19	12



### Pinza pan

Pince à pain · Brotzange  
Bread tong · Pinça pão

Ref	€	L (cm)	U.Venta
62978	8,80	18	1



### Pinza pan

Pince à pain · Brotzange  
Bread tong · Pinça pão

Ref	€	L (cm)	U.Venta
62982	16,90	23	12



### Pinza ensalada

Pinces a salade · Salatzange  
Salad scissor tong · Pinça de salada

Ref	€	L (cm)	U.Venta
68021	4,80	28,5	12



### Tenedor + cuchara ensalada

Fourchette + cuillère a salade · Gabel + Löffel Acryl  
Salad spoon + fork · Garfo + colher de salada

Ref	€	L (cm)	U.Venta
62399	7,60	30	1



### Pinza repostería

Pince à gateau · Gebäck-Tortenzange  
Cake tong · Pinça pastelaria

Ref	€	L (cm)	U.Venta
62317	11,70	20	1



### Pinza repostería con anillas

Pince à gateau avec anneaux · Gebäckzange  
Cake tong with rings · Pinça pastelaria com anilhas

Ref	€	L (cm)	U.Venta
68008	5,90	16	6



### Pinza para bolsitas de té

Pince pour sachets de thé · Teebeutelzange  
Tea bag tong · Pinças para saquetas de chá

Ref	€	L (cm)	U.Venta
A 68078	2,30	13,5	1
B 68079	3,50	14,0	1

- Exprime fácilmente tu infusión sin riesgo de mancharte o quemarte.
- Diseñada para una extracción fácil y efectiva de la bolsa de té.
- Orificios para exprimir hasta la última gota.
- Mango de acero inoxidable para un agarre cómodo y seguro.

- Squeeze easily your infusion without the risk of leaving or burning yourself.
- Designed for easy and effective tea bag removal.
- Holes for squeezing out the last drop.
- Stainless steel handle for a comfortable and safe grip.



### Pinza hielo

Pince à glace · Eiszange  
Ice tong · Pinça de gelo

Ref	€	L (cm)	U.Venta
A 62306	4,60	18,5	12
B 62337	9,90	20,0	12



### Pinza multiusos LUXE

Pince multi-usages · Allzweck Zange  
Multipurpose tong · Pinça multiusos

Ref	€	L (cm)	U.Venta
62334	19,80	25	1



### Pinza azucarillos

Pince à sucre · Zucker-Zange  
Food tong · Pinça p/cubos de açúcar

Ref	€	L (cm)	U.Venta
62985	3,70	11	6



### Pinza multiusos

Pince multi-usages · Allzweck-Zange  
Luxe tong · Pinça multiusos

Ref	€	L (cm)	U.Venta
62984	3,80	16	5



### Pinza LUXE

Pince · Zange  
Tong · Pinça

Ref	€	L (cm)	U.Venta
62983	15,30	30	12



### Pinza grill

Pince à grill · Grilltange  
Grill tong · Pinça grelhador

Ref	€	L (cm)	U.Venta
62933	15,00	30	6



### Pinza grill

Pince à grill · Grilltange  
Grill tong · Pinça grelhador

Ref	€	L (cm)	U.Venta
62931	9,00	29	1

New



2 in 1

**Pinza DUPLO**  
Pince · Zange  
Tong · Pinça

Ref	€	L (cm)	U.Venta
63049	11,60	30	1



- Fabricada en acero inoxidable 18/10 con bordes biselados y mango termorresistente.
- Pinza interior fabricada en nylon. No raya ni daña artículos de cocina con antiadherente. Resistente al calor.
- Fácil limpieza: aptas para el lavavajillas.
- Fabriquée en acier inoxydable 18/10 avec des bords biseautés et un manche thermorésistant.
- Pince intérieure fabriqué en nylon. Ne raye pas et n'endommage pas les ustensiles de cuisine antiadhésifs. Résistante à la chaleur.
- Nettoyage facile : apte pour le lave-vaisselle.
- Made of 18/10 stainless steel with bevelled edges and a heat resistant handle.
- Inner tong made of nylon. Does not scratch cooking utensils with non-stick coating. Heat resistant.
- Easy to Clean: dishwasher safe.

Mango revestido con una capa de aislante térmica para una mejor sujeción  
Handle coated with a layer of thermal insulation and an enhanced grip



**Pinzas KARU**  
Pincas · Zanges  
Tongs · Pinças

	Ref	€	L (cm)	Color	U.Venta	Ref	€	L (cm)
<b>A</b>	63060	7,30	24	<b>Rojo</b> · Red	12	63070	7,90	30
<b>B</b>	63061	7,30	24	<b>Negro</b> · Black	12	63071	7,90	30
<b>C</b>	63062	7,30	24	<b>Azul</b> · Blue	12	63072	7,90	30
<b>D</b>	63063	7,30	24	<b>Amarillo</b> · Yellow	12	63073	7,90	30
<b>E</b>	63064	7,30	24	<b>Verde</b> · Green	12	63074	7,90	30
<b>F</b>	63065	7,30	24	<b>Marrón</b> · Brown	12	63075	7,90	30



**Pinzas silicona**

Pincas silicon · Silikon Zanges  
Silicone tongs · Pinças silicone

	Ref	€	L (cm)	Color	U.Venta
<b>A</b>	64434	67,50	18,0	<b>Caja (25 pcs.)</b> · Set (25 pcs.)	1
<b>B</b>	64432	2,90	18,0	<b>Naranja</b> · Orange	12
<b>C</b>	64433	2,90	18,0	<b>Rojo</b> · Red	12
<b>D</b>	64436	2,90	18,0	<b>Azul</b> · Blue	12
<b>E</b>	64437	2,90	18,0	<b>Verde</b> · Green	12
<b>F</b>	64439	2,90	18,0	<b>Morada</b> · Purple	12



# PINZAS PRECISIÓN

## Colección

Inox 18/10  
Dishwasher



ES

- Pinzas de precisión fabricada en acero inoxidable 18/10 de máxima calidad.
- Ideales para manipular y emplatar tus creaciones a la perfección.
- Mango antideslizante y puntas acanaladas para una sujeción 100% segura.
- Aptas para lavavajillas.

FR

- Pincas à dresser fabriquée en acier inoxydable 18/10 de la plus grande qualité.
- Idéales pour manipuler et dresser vos créations à la perfection.
- Manche antidérapant et pointes rainurées pour une adhésion 100% efficace.
- Apte pour le lave-vaisselle.

EN

- Precision tongs made of top quality 18/10 stainless steel.
- Perfects for presenting your creations with solid food.
- Non-slip handle and channelled tips for 100% secure holding.
- Dishwasher safe.

Puntas curvas puntiagudas y rugosas  
Curved tipspointed and rough



**Pinza de precisión recta**

Pince de précision droite · Präzisionszange glatt  
Straight precision tong · Pinça de precisão reta

Ref	€	L (cm)	U.Venta
62955	5,30	15,5	1
62956	10,30	21,0	1

Acabado negro mate  
Finish in matte black



**Pinza de precisión TITAN BLACK**

Pince de précision · Präzision zange  
Precision tong · Pinça de precisão

Ref	€	L (cm)	U.Venta
62872	5,90	21	1
62874	4,50	16	1

**Pinza de precisión acodada**

Pince de précision · Präzision zange  
Precision tong · Pinça de precisão

Ref	€	L (cm)	U.Venta
62865	4,70	15,5	1

Acabado iridiscente  
Iridescent finish



**Pinza de precisión TITAN RAINBO**

Pince de précision · Präzision zange  
Precision tong · Pinça de precisão

Ref	€	L (cm)	U.Venta
62873	5,90	21	1
62875	4,50	16	1



**Pinza de precisión INOX**

Pince de précision · Präzision zange  
Precision tong · Pinça de precisão

	Ref	€	L (cm)	U.Venta
<b>A</b>	62954	5,30	16	1
<b>B</b>	62821	6,20	21	1

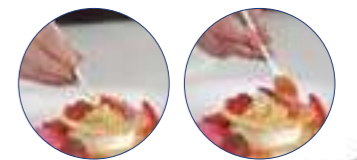

**Pinza de precisión con cuchara**

Pince de précision a/cuillère · Präzision zange m/Löffel  
Precision tong with spoon · Pinça de precisão c/colher

Ref	€	L (cm)	U.Venta
62863	5,80	17,0	1



### Cuchara para miel

Cuillère à miel · Honiglöffel aus Edelstahl  
St steel honey spoon · Colher para mel

Ref	€	L (cm)	U.Venta
61361	10,60	16,5	1

Zamak  
Zinc alloy



### Tenaza extractor huesos aceitunas

Dénoyauteur, Chromé · Olivenentsteiner, Verchromt  
Zinc alloy live seed remover · Tenaz extrator de ossos de azeitonas

Ref	€	L (cm)	U.Venta
62973	8,00	16	1



### Pinza para horno/bandeja GN

Pince inox pour bac GN · Zange für GN Behälter  
Tong GN tray · Pinça para forno e bandejas GN

Ref	€	L (cm)	U.Venta
62989	17,00	20	12



### Pinza quitaespinas

Pince à arêtes · Grätenzange  
Fish-bone tweezers · Pinça tira-espinhas

Ref	€	L (cm)	U.Venta
62938	4,70	8	1
62928	5,90	12	1

Inox



### Desescamador de pescado MINI

Grattoir de poissons · Fischschuppenentferner  
Fish scraper · Raspador de peixe

Ref	€	L (cm)	U.Venta
39040	8,20	19	1



Las escamas se quedan atrapadas en la funda  
The scales get trapped in the cover

Sistema patentado

Si  
Silicone

A

Click here



Doble hojas dentadas  
Double toothed slats



Doble hojas dentadas  
Double toothed slats

### Desescamador de pescado

Grattoir de poissons · Fischschuppenentferner  
Fish scraper · Raspador de peixe

Ref	€	L (cm)	U.Venta
39041	11,80	27,5	1

### Desescamador de pescado SAFE

Grattoir de poissons · Fischschuppenentferner  
Fish scraper · Raspador de peixe

Ref	€	Cabezal (cm)	L (cm)	U.Venta
39042	24,00	9x13,5	30	1
A R39042A	7,90	9x13,5	14	1

Funda silicona  
Silicone cover



Si  
Silicone 200°C

### Pinza para horno/bandeja GN

Pince inox pour bac GN · Zange für GN Behälter  
Tong GN tray · Pinça para forno e bandejas GN

Ref	€	L (cm)	U.Venta
62998	17,00	20	12

Zamak  
Zinc alloy



### Cascanueces BASIC

Casse Noix · Nussknacker  
Nut Cracker · Parte-nozes

Ref	€	U.Venta
63016	15,40	6

Zamak  
Zinc alloy



### Cascanueces 3 in 1

Casse Noix · Nussknacker  
Nut Cracker · Parte-nozes

Ref	€	U.Venta
63017	19,30	6

Inox



### Tenaza marisco

Pince à casse-homard · Hummerzange  
Lobster cracker · Tenaz mariscos

Ref	€	L (cm)	U.Venta
62908	15,50	16	12

Inox



### Tijera - tenaza marisco

Pince casse homard · Schere/Zange Meeresfrüchte  
Sea food scissor-tong · Tesoura-tenaz marisco

Ref	€	L (cm)	U.Venta
62974	17,10	18,5	12

### Abre ostras LUXE

Couteau à huîtres · Austermesser  
Oyster openne · Aberto-ostras

Ref	€	L (cm)	U.Venta
62684	12,60	20	1



6  
units

### Pinchos para marisco

Curettes à homard · Hummergabel  
Seafood forks · Espetos para marisco

Ref	€	L (cm)	U.Venta
62976	29,90	18,5	1

New



### Pinza quitaespinas

Pince à arêtes · Grätenzange  
Fish-bone tweezers · Pinça tira-espinhas

Ref	€	L (cm)	U.Venta
62879	4,70	13	1

- Pinza especial para quitar de forma precisa las espinas del pescado.
- Fabricada en acero inoxidable 18/10 de alta calidad.
- Brazos curvados; facilitan su agarre y le dan más fuerza
- Acabado en mate. Higiénica y resistente.

- Pince spécialement conçue pour retirer avec précision les arêtes du poisson.
- Fabriquée en acier inoxydable 18/10 de grande qualité.
- Bras courbés; facilite la prise en main et lui donne plus de force.
- Finition mate. Hygiénique et durable.

- Special tweezers for precise removal of fish bones.
- Made of top quality 18/10 stainless steel.
- Curved arms; easier to grip and give you more strength.
- Matt finish. Hygienic and durable.

# BBQ

## Colección

Inox



### ES

- Práctico maletín de aluminio compuesto por 5 utensilios para barbacoa: espátula, tenedor, cuchillo, pinza dentada y brocha.
- Todas las piezas fabricadas en acero inoxidable de máxima calidad.
- Mango ergonómico, resistente al calor.
- Maletín rectangular portátil con el interior forrado.
- Completa el set con los accesorios adicionales: espátula acodada y cepillo de limpieza.

### FR

- Malette pratique en aluminium composée de 5 ustensiles pour barbecue : spatule, fourchette, couteau, pince dentée et broche.
- Toutes les pièces sont fabriquées en acier inoxydable de la plus grande qualité.
- Manche ergonomique, résistant à la chaleur.
- Malette rectangulaire transportable avec revêtement intérieur.
- Complétez l'ensemble avec les accessoires supplémentaires : spatule coudée et brosse de nettoyage.

### EN

- Practical aluminium case with 5 barbecue utensils: spatula, fork, knife, serrated tongs and brush.
- All parts made of top-quality stainless steel.
- Ergonomic, heat-resistant handle.
- Portable rectangular case with lined interior.
- Complete the set with these additional accessories: angled spatula and cleaning brush.



#### Maletín

Malette · Koffer  
Briefcase · Maleta

Ref	€	cm	U.Venta
60260	46,70	47x16,6x8	1



#### Tenedor

Fourchette · Tranchiergabel  
Fork · Garfo

Ref	€	L (cm)	U.Venta
60261	5,10	43,5	1



#### Cuchillo

Couteau · Messer  
Knife · Faca

Ref	€	L (cm)	U.Venta
60262	4,90	41,5	1



#### Espátula

Spatule · Schaufel  
Spatule · Espátula

Ref	€	L (cm)	U.Venta
60263	8,10	45,5	1



#### Brocha

Broche · Bürstes  
Brush · Escova

Ref	€	L (cm)	U.Venta
60264	6,10	44,0	1



#### Pinza

Pincs · Zange  
Tong · Pinça

Ref	€	L (cm)	U.Venta
60265	9,90	43,5	1

#### Accesorios · Accessoires · Accessories



#### Espátula acodada

Spatule coudées · Winkelpalette  
Bent spatule · Espátula comprida

Ref	€	L (cm)	U.Venta
60266	5,80	28,0	1



#### Cepillo de limpieza

Brosse de nettoyage · Reinigungsbürste  
Cleaning brush · Escova de limpeza

Ref	€	L (cm)	U.Venta
60267	6,80	45,0	1



# MOLINILLOS DE CAFÉ

## Colección



Número de tazas Number of cups	Tiempo de molido Grinding time
2	8 seg
4	12 seg
6	20 seg
8	24 seg
10	28 seg
12	30 seg

19 diferentes niveles de molienda · 19 different grind sizes



### Molinillo KALDI

Moulin · Mühle  
Grinder · Moinho

Ref	€	W	g	U.Venta
69485	117,70	200	200 / 100	1

- Disfruta de todo el aroma y sabor de un café recién molido.
- Embudo de 200 g de capacidad con tapa.
- Fresa cónica de acero inoxidable; muele el café uniformemente.
- 19 diferentes niveles de molido; se adapta a todo tipo de cafeteras y a la intensidad de sabor que se desee.
- Selector de tazas de 1 a 12 tazas. Mantiene los granos frescos y evita el desperdicio del café.
- Contenedor transparente extraíble de 100 g. Libre de BPA.

- Enjoy the taste and aroma of freshly ground coffee.
- Hopper with a capacity of 200 g with a lid.
- Conical stainless steel cutter to ensure the coffee is ground uniformly.
- 19 different grind sizes to choose from, suitable for all types of coffee machines and for all flavour intensities.
- Choose between 1 and 12 cups to keep the coffee grounds fresh and avoid wasting coffee.
- Removable 100 g transparent container.BPA-free.

#### Características · Characteristics:

**Referencia** · Reference: 69485  
**Tensión** · Voltage: 220-240 V; 50-60 Hz  
**Potencia** · Power: 200 W  
**Capacidad** · Capacity: 200 g (grano · grains) / 100 g (molido · ground)  
**Niveles de molido** · Grinding levels: 19  
**Dimensiones** · Sizes: 15,2x21x26 cm  
**Peso** · Weight: 1,85 kg

- 100% acero inoxidable: cuerpo y cuchillas fabricados en acero inoxidable de máxima calidad.
- Tapa transparente: tapa superior de color transparente para visualizar el grano molido. Libre de BPA.
- Interruptor ON/OFF: funcionamiento con un simple botón (inicio/parada).
- Interruptor de seguridad: las cuchillas se activan solo cuando la tapa está correctamente cerrada.
- Almacenamiento para el cable.

- 100% Stainless Steel: Body and blades made of top quality stainless steel.
- Transparent Lid: Transparent upper lid so you can see the ground product. BPA Free.
- ON/OFF Button: Works with a simple button (start/stop).
- Safety Switch: The blades are only activated when the lid is properly closed.
- Storage for the cord.

#### Características · Characteristics:

**Referencia** · Reference: 69385  
**Tensión** · Voltage: 220-240 V; 50-60 Hz  
**Potencia** · Power: 200 W  
**Capacidad** · Capacity: 60 g (9 cups)  
**Dimensiones** · Sizes: Ø10x18 cm  
**Peso** · Weight: 0,78 kg



Inox

60 g



Ideal para moler café, semillas, frutos secos, etc.  
Perfect for grinding coffee, seeds, nuts, etc.



### Molinillo LIMU

Moulin · Mühle  
Grinder · Moinho

Ref	€	W	g	U.Venta
69385	37,20	200	60	1

8 niveles de grosor  
8 grinding levels

Inox 18/10  
Cristal Glass



Mecanismo cerámico  
Ceramic mechanism



### Molinillo manual

Moulin manuel · Manuelle Mühle  
Manual grinder · Moinho manual

Ref	€	g	h (cm)	U.Venta
62817	33,20	45	21	1

8 Niveles de grosor · 8 Grinding levels



- Muele al instante y conserva mejor las propiedades y aromas.
- Ideal para moler café y otros alimentos como semillas, hierbas, frutos secos, cereales, sal, pimienta, azúcar o especias.

- Moud à l'instant et conserve mieux les propriétés et les arômes.
- Idéal pour moudre le café et d'autres aliments tels que les graines, les herbes, les fruitssecs, les céréales, le sel, le poivre ou les épice.

- Grinds instantly and better preserves the properties and aromas.
- Perfect for grinding coffee or other aliments like seeds, herbs, nuts, grains, salt, pepper, sugar or spices.

# ESPUMADORES DE LECHE

## Colección



ES

- Disfruta de una espuma fina y cremosa en pocos segundos.
- Capacidad espuma: 115 ml / Capac. calentamiento: 240 ml (69396) - 250 ml (69398).
- Tecnología magnética, el movimiento de los accesorios se crea por atracción (69398).
- Base independiente rotativa de 360°, fácil de rellenar y verter.
- Funcionamiento silencioso. Apagado automático.
- Indicador de luz que visualiza si la leche está caliente o fría.
- Apta para leches vegetales. Fácil de limpiar.

FR

- Obtenez une mousse fine et crémeuse en secondes seulement.
- Capacité de mousse : 115 ml / Capacité de chauffe : 240 ml (69396) - 250 ml (69398).
- Technologie magnétique, le mouvement des accessoires a lieu par attraction (69398).
- Base indépendante rotative de 360°C, sans fil, facile à remplir et à verser.
- Fonctionnement silencieux. Arrêt automatique.
- Indicateur lumineux qui indique si le lait est chaud ou froid.
- Apte pour les laits végétaux. Facile à nettoyer.

EN

- Enjoy a fine, creamy foam in as little seconds.
- Frothing capacity: 115 ml / Heating capacity: 240 ml (69396) - 250 ml (69398).
- Magnetic technology: The movement of the accessories is created with attraction (69398).
- 360° rotating independent base, easy to fill and pour.
- Silent operation. Automatic shut-off.
- The indicator light shows whether the milk is hot or cold.
- Suitable for plant milk and easy to clean.



Calentar  
Heat



Calentar y espumar.  
Espumar leche fría  
Heat and froth.  
Froth cold milk



### Espumador de leche LATTE

Mousseur à lait · Milchaufschäumer  
Milk frother · Espumador de leite

Ref	€	W	ml	U.Venta
69396	61,80	500	240	1



### Espumador de leche MAGNETIC

Mousseur à lait · Milchaufschäumer  
Milk frother · Espumador de leite

Ref	€	W	ml	U.Venta
69398	76,80	600	250	1

Ref	Tensión/Voltage	Potencia/Power	Cap. espuma/Cap. foam	Cap. leche/Cap. milk	Base/Base	Dimensiones/Sizes	Peso/Weight
69396	220-240 V; 50/60 Hz	500 W	115 ml	240 ml	360°	Ø10x21 cm	650 g
69398	220-240 V; 50/60 Hz	600 W	115 ml	250 ml	360°	Ø11,8x19,5 cm	900 g

# CAFETERAS EXPRESSO

## Colección

Inox  



Prepara  
1 o 2 cafés  
Make 1 or 2 coffees

Calienta y espuma  
la leche  
Heat and froth milk



### Cafetera espresso SENCE

Cafetière espresso · Espresso-Maschine  
Espresso coffee maker · Cafeteira espresso

Ref	€	W	L	U.Venta
69256	184,20	850	1,50	1

- Cafetera espresso ideal para preparar todo tipo de cafés, espresso, cappuccino, latte machiato, etc.
- Conseguirás un café perfecto y rápido gracias a sus 15 bares de presión.
- Fácil de usar, muy intuitiva. Indicadores luminosos en cada función.
- Función manual y automática. Permite programar el ciclo de vertido a tu gusto.
- Incluye vaporizador con protección para espumar leche y preparar cappuccinos.
- Brazo portafiltros con doble salida, te permite preparar uno o dos cafés a la vez.
- Depósito de agua extraíble de 1,5 litros de capacidad con marcas de máximo y mínimo.
- Bandeja caliente tazas de acero inoxidable, calienta la taza previamente para evitar el contraste térmico.
- Incluye cucharilla dosificadora con prensador para el café y 3 filtros (individual, doble y para usar cápsulas ESE) para acoplar al brazo de la cafetera.
- Bandeja de goteo desmontable con indicador de nivel para facilitar la limpieza.
- Sistema de ahorro energético con apagado automático.
- Apta para usar con café molido y con cápsulas ESE.

- Espresso coffee machine, perfect for making all types of coffee, including espresso, cappuccino, latte, macchiato, etc.
- You'll have a perfect coffee in no time at all thanks to its 15 pressure bars.
- It's easy to use and very intuitive. Each function is accompanied by light indicators
- Manual and automatic settings. You can personalise the pouring time.
- Includes a steam wand with a protector for frothing milk, dispensing hot water for teas and preparing cappuccinos.
- The two-spout filter holder allows you to make one or two coffees at the same time.
- Removable 1.5-litre water tank with minimum and maximum water level marks.
- Stainless steel cup-warming tray heats up the cups before using them to keep the coffee warmer for longer.
- Includes a coffee measuring spoon and tamper and 2 filters (single, double and to use ESE capsules) to attach to the handle.
- Detachable drip tray with water level indicator to aid cleaning.
- Energy-saving system with automatic shut-off.
- Suitable for use with ground coffee and ESE capsules.



Prepara  
1 o 2 cafés  
Make 1 or 2 coffees

Calienta y espuma  
la leche  
Heat and froth milk



### Cafetera espresso COMPACT

Cafetière espresso · Espresso-Maschine  
Espresso coffee maker · Cafeteira espresso

Ref	€	W	L	U.Venta
69429	228,90	1450	1,25	1

- Ideal para preparar todo tipo de cafés, espresso, cappuccino, latte machiato, té o infusiones.
- Su sistema de calentamiento rápido Thermoblock calienta el agua en segundos.
- Fácil de usar, muy intuitiva. Indicadores luminosos en cada función.
- Función manual y automática. Permite programar el ciclo de vertido a tu gusto.
- Incluye vaporizador con rotación para espumar leche y preparar cappuccino. También dispensa agua caliente para las infusiones.
- Brazo portafiltros con doble salida, te permite preparar uno o dos cafés simultáneamente.
- Depósito de agua extraíble de 1,25 litros de capacidad con marcas de máximo y mínimo. Libre de BPA.
- Bandeja caliente tazas de acero inoxidable, calienta la taza previamente para evitar el contraste térmico.
- Incluye cucharilla dosificadora con prensador para el café y 3 filtros (individual, doble y para usar cápsulas ESE) para acoplar al brazo de la cafetera.
- Bandeja de goteo desmontable con indicador de nivel para facilitar la limpieza.
- Sistema de ahorro energético con apagado automático.
- Apta para usar con café molido y con cápsulas ESE.

- It's perfect for making all kinds of coffee, espresso, cappuccino, latte macchiato, tea or infusions.
- Its Thermoblock fast heating system heats water in seconds.
- It is easy to use and very intuitive and has light indicators for every function.
- Manual and automatic operation, the amount of coffee to be made can be programmed to taste.
- Swivelling steam wand included to froth milk and make cappuccino. It also dispenses hot water for infusions.
- The portafilter with two outlets lets you make one or two cups of coffee at the same time.
- It has a removable 1.25 litre water tank with minimum and maximum marks. BPA free.
- It has a stainless steel cup heating tray to heat cups beforehand to prevent temperature contrasts.
- It includes a spoon with a tamper for coffee and three filters (single, double and for using ESE pods) that attach to the portafilter.
- It has a removable drip tray with a level indicator to make cleaning easy.
- It has an energy savings system with automatic shut off.
- It can be used with ground coffee or ESE pods.

Ref	Tensión/Voltage	Potencia/Power	Presión/Pressure	Capacidad/Capacity	Dimensiones/Sizes	Peso/Weight
69429	220-240 V ; 50/60 Hz	1450 W	20 bar	1,25 L	14x31x31 cm	3,40 Kg

Ref	Tensión/Voltage	Potencia/Power	Presión/Pressure	Capacidad/Capacity	Dimensiones/Sizes	Peso/Weight
69256	220-240 V ; 50/60 Hz	850 W	15 bar	1,50 L	21x26,5x30 cm	3,60 Kg



Prepara  
1 o 2 cafés  
Make 1 or 2 coffees

Calienta y espuma  
la leche  
Heat and froth milk



### Cafetera Espresso PRO

Cafetière espresso · Espresso-Maschine  
Espresso coffee maker · Cafeteira espresso

Ref	€	W	L	U.Venta
69428	641,90	1550	2,80	1

- Cafetera espresso de acero inoxidable con acabado pulido. Ideal para preparar todo tipo de cafés, espresso, cappuccino, latte machiato, té o infusiones.
- Consigue un café perfecto y rápido gracias a su potencia de 1550 W y sus 20 bares de presión.
- Molinillo con fresa cónica de acero inoxidable integrado que proporciona la cantidad necesaria de café.
- Depósito de café de 250g con opción de regular entre 30 tipos de molido. Libre de BPA.
- Control de temperatura PID. Alcanza la temperatura de extracción óptima.
- Fácil de usar, muy intuitiva. Indicadores luminosos en cada función.
- Función manual y automática. Permite programar la cantidad de vertido a tu gusto.
- Incluye vaporizador con rotación para espumar leche y preparar cappuccino. También dispensa agua caliente para las infusiones.
- Brazo portafiltros con doble salida, te permite preparar uno o dos cafés simultáneamente.
- Depósito de agua extraíble de 2,8 litros de capacidad con marcas de máximo y mínimo. Libre de BPA.
- Incluye prensador de acero inoxidable para el café, 2 filtros (individual y doble) para acoplar al brazo de la cafetera y jarra de acero inoxidable de 0,46 L para la leche.
- Bandeja de goteo desmontable con indicador de nivel para facilitar la limpieza.
- Sistema de ahorro energético con apagado automático.

- Stainless steel espresso maker with a polished finish
- It's perfect for making all kinds of coffee, espresso, cappuccino, latte macchiato, tea or infusions.
- It can make perfect coffee quickly thanks to its 1550 W of power and 20 bars of pressure.
- A coffee grinder with a stainless steel cone burr that provides the right amount of coffee.
- It has a 250 g bean hopper and 30 types of grinding to choose from. It's BPA free.
- PID temperature control, it uses the optimum extraction temperature.
- It is easy to use and very intuitive and has light indicators for every function.
- Manual and automatic operation, the amount of coffee to be made can be programmed to taste.
- Swivelling steam wand included to froth milk and make cappuccino. It also dispenses hot water for infusions.
- The portafilter with two outlets lets you make one or two cups of coffee at the same time.
- It has a removable 2.8 litre water tank with minimum and maximum marks. BPA free.
- It includes a stainless steel tamper for coffee, two filters (single and double) that attach to the portafilter and a 0,46 L stainless steel pitcher for milk.
- It has a removable drip tray with a level indicator to make cleaning easy.
- It has an energy savings system with automatic shut off.

Ref	Tensión/Voltage	Potencia/Power	Presión/Pressure	Capacidad/Capacity	Capacidad/Capacity	Dimensiones/Sizes	Peso/Weight
69428	220-240 V ; 50/60 Hz	1550 W	20 bar	2,80 L (depósito agua)	250 g (depósito café)	31x34,5x41,5 cm	8,00 Kg

# INOX

## Cafeteras



Disponen de válvula de seguridad  
They have a safety valve



### ES

- Cafetera italiana fabricada en acero inoxidable 18/10 de gran calidad y máxima resistencia.
- Boquilla en pico para servir directamente sin derramar ni una sola gota.
- Máxima seguridad garantizada: dispone de válvula de seguridad y asa termorresistente.
- 100% hermético gracias a su junta de cierre de silicona.
- Alta conductividad térmica.
- Capacidad para 4/6/10 tazas de café.
- Fondo FULL INDUCTION: apta para todo tipo de fuegos, incluida la inducción.
- Muy fácil de limpiar: apta para el lavavajillas.

### FR

- Cafetière italienne fabriquée en acier inoxydable 18/10 de grande qualité et d'une résistance maximale.
- Bec verseur en pointe pour servir directement sans renverser une seule goutte.
- Sécurité maximum garantie : dispose d'une soupape de sécurité et d'une anse thermorésistante.
- 100% hermétique grâce à son joint de fermeture en silicone.
- Haute conductivité thermique.
- Capacité pour 4/6/10 tasses de café.
- Fond FULL INDUCTION : apte pour tout type de cuisinières, y compris l'induction.
- Très facile à nettoyer : apte pour le lave-vaisselle.

### EN

- Moka pot made of high quality and extremely strong 18/10 stainless steel.
- Pointed spout for serving the coffee without spilling a drop.
- Guaranteed maximum safety: pressure valve and heat resistant handle.
- 100% Hermetic because of the silicone seal.
- High thermal conductivity.
- Capacity for 4/6/10 cups of coffee.
- FULL INDUCTION bottom: suitable for all kinds of cookers, including induction.
- It's very easy to clean and dishwasher safe.



Acabado MATE  
SATIN finish

### Cafetera express HYPERLUXE

Cafetière express · Espresso-Kocher  
Express coffee · Cafeteira café expresso

Ref	€	Tazas	U.Venta
62074	80,40	4	1
62076	88,80	6	1
62071	101,50	10	1



Acabado BRILLO  
GLOSS finish

### Cafetera express LUXE

Cafetière express · Espresso-Kocher  
Express coffee · Cafeteira café expresso

Ref	€	Tazas	U.Venta
62084	65,80	4	1
62086	76,80	6	1
62081	90,70	10	1



Acabado BRILLO  
GLOSS finish

### Cafetera express MOKA

Cafetière express · Espresso-Kocher  
Express coffee pot · Cafeteira expresso

Ref	€	Tazas	ml	U.Venta
62054	55,00	4	200	1
62056	63,00	6	310	1
62051	74,70	10	500	1



Acabado BRILLO  
GLOSS finish

### Cafetera express MILAN

Cafetière express · Espresso-Kocher  
Express coffee pot · Cafeteira expresso

Ref	€	Tazas	Ø Base (cm)	h (cm)	U.Venta
62033	21,50	4	8,0	16,0	1
62036	25,10	6	9,0	19,5	1
62031	31,30	10	10,0	21,0	1

Asa abatible y pomo de baquelita  
Folding handle and Bakelite knob



Acabado BRILLO  
GLOSS finish

### Cafetera PAVA

Cafetière pava · Kaffeekanne Pava  
Coffee pot · Chaleira

Ref	€	Ø Base (cm)	L	U.Venta
68215	34,70	10,0	1,00	1
68225	41,80	13,5	2,00	1
68235	51,00	15,0	2,80	1
68205	58,70	16,0	4,00	1



Infusiona café molido con agua y consigue un café de gran sabor y aroma  
Water and ground coffee infuse to make a coffee with great taste and aroma



Acabado BRILLO  
GLOSS finish

### Cafetera express SIENA

Cafetière express · Espresso-Kocher  
Express coffee pot · Cafeteira expresso

Ref	€	Tazas	Ø Base (cm)	h (cm)	U.Venta
62124	48,60	4	8,5	18,0	1
62126	58,70	6	9,0	18,5	1
62121	70,20	10	10,5	21,5	1

# ALUMINIO

## Cafeteras



ES

- Cafetera italiana fabricada en aluminio fundido de gran calidad y máxima resistencia.
- Máxima seguridad garantizada: dispone de válvula de seguridad y asa de baquelita (Turin) / asa de madera de Haya (Trento) termorresistente.
- 100% hermético gracias a su junta de cierre de silicona.
- Alta conductividad térmica.

FR

- Cafetières italienne fabriquées en fonte d'aluminium de grande qualité et d'une résistance maximale.
- Sécurité maximum garantie : dispose d'une soupape de sécurité et d'une anse en bakélite (Turin) / anse en bois de hêtre (Trento) thermorésistante.
- 100% hermétique grâce à son joint de fermeture en silicone.
- Haute conductivité thermique.

EN

- Moka pot coffee maker made of high quality and very strong cast aluminium.
- Guaranteed maximum safety: pressure valve and heat resistant bakelite handle (Turin) / beech wood handle (Trento).
- 100% Hermetic because of the silicone seal.
- High thermal conductivity.



**Cafetera express TURIN**

Cafetière express · Espressoemaker  
Express coffee pot · Cafeteira expresso

Ref	€	Tazas	Ø Base (cm)	h (cm)	U.Venta
62026	16,90	6	9,5	19,0	1
62029	21,10	9	10,5	21,5	1
62022	23,30	12	12,0	25,0	1



**Cafetera express TRENTO**

Cafetière express · Espressoemaker  
Express coffee pot · Cafeteira expresso

Ref	€	Tazas	Ø Base (cm)	h (cm)	U.Venta
62046	29,90	6	8,5	20,0	1
62048	38,10	9	9,0	22,5	1
62096	29,90	6	8,5	20,0	1
62099	38,10	9	9,0	22,5	1

# FRANCESAS

## Cafeteras



ES

- Cafeteras clásicas manuales.
- Fabricadas en vidrio borosilicatos, superresistentes a los cambios de temperatura.
- Filtro robusto de acero inoxidable 18/10; asegura una buena textura y sabor.
- Boquilla en pico para servir directamente sin derramar ni una sola gota.
- Forma práctica y sencilla de preparar los mejores cafés e infusiones en pocos minutos.

FR

- Cafetières classiques manuelles.
- Fabriquées en verre borosilicate, super résistant aux changements de température.
- Filtre robuste en acier inoxydable 18/10 ; garantit une texture et un goût excellents.
- Bec verseur pour servir directement sans renverser pas une seule goutte.
- Façon pratique et simple de préparer les meilleurs cafés et infusions en quelques minutes seulement.

EN

- Traditional manual coffee maker.
- Made of borosilicate glass, extremely resistant to temperatures changes. · High strength stainless steel 18/10 filter that ensures good flavour and texture.
- Spout nozzle to serve directly without spill not a single drop.
- An easy and practical way to make the best coffee and tea in just a few minutes.



**Cafetera francesa**

Cafetière à piston · Französische kaffemaschine  
French coffee maker · Cafeteira francesa

Ref	€	Tazas	L	U.Venta
62173	19,10	3	0,35	1
62178	26,10	6	0,80	1
62183	8,30	3	0,35	6
62186	12,80	6	0,80	1

**Cafetera francesa WOOD**

Cafetière à piston · Französische kaffemaschine  
French coffee maker · Cafeteira francesa

Ref	€	Tazas	L	U.Venta
62163	10,90	3	0,35	1
62168	14,60	6	0,80	1
62161	15,10	8	1,00	1



**Cafetera de cristal**

Cafetière en verre · Glaskaffeemaschine  
Coffee pot w/glass · Cafeteira vidro

Ref	€	Tazas	L	U.Venta
62153	29,60	2	0,35	1
62180	42,00	6	0,80	1

# CLASSIC

## Colección

Inox 18/10  
Dishwasher



**Tetera**  
Théière · Teekanne  
Tea pot · Bule

Ref	€	L	U.Venta
62023	18,90	0,23	12
62035	21,00	0,35	12
62060	28,60	0,60	6
62010	35,10	1,00	1



**Cafetera**  
Cafetière · Kaffeekanne  
Coffee pot · Cafeteira

Ref	€	L	U.Venta
62135	22,90	0,35	6
62160	30,80	0,60	6
62110	34,10	1,00	6
62115	47,60	1,50	1
62120	54,80	2,00	1



**Lechera**  
Cremière · Milchkanne  
Creamer · Leiteira

Ref	€	L	U.Venta
62215	8,80	0,15	6
62225	14,00	0,25	6
62235	14,70	0,35	6
62260	17,20	0,60	6
62210	21,50	1,00	6
62216	33,40	1,50	6
62220	39,80	2,00	6

**Azucarero**  
Sucrier · Zuckerdose  
Sugar bowl · Açucareiro

Ref	€	L	U.Venta
A 62001	16,00	0,23	6
B 62003	20,70	0,35	1



# LUXE

## Colección

Inox 18/10  
Dishwasher



**Tetera**  
Théière · Teekanne  
Tea pot · Bule

Ref	€	L	U.Venta
65025	37,80	0,25	1
65035	40,00	0,35	1
65060	47,20	0,60	1
65012	59,40	1,20	1



**Cafetera**  
Cafetière · Kaffeekanne  
Coffee pot · Cafeteira

Ref	€	L	U.Venta
65135	39,40	0,35	1
65160	47,10	0,60	1
65110	59,80	1,00	1



**Lechera**  
Cremière · Milchkanne  
Creamer · Leiteira

Ref	€	L	U.Venta
65215	14,30	0,15	6
65235	24,50	0,35	6
65260	29,50	0,60	6

# CAPUCCINO

## Batidor

ABS plastic  
SAN plastic  
Dishwasher  
BPA free



Varillas Inox  
Rods Inox

**Batidor capuccino**  
Batteur pour cappuccino · Capuccino-Mixer  
Capuccino mixer · Batedor capuccino

Ref	€	W	U.Venta
69041	26,70	2,7	1

**Incluye:** Vaso medidor  
Base para guardar el batidor y varillas  
Varilla agitadora  
Varilla para espumar  
Batidor  
Mezclador

**Includes:** Measuring cup  
Base to store the whisk and rods  
Stirring rod  
Frothing rod  
Whisk  
Mixer

# LECHERAS

## Colección

Inox 18/10  
Dishwasher

ES

- Ideales para bares, cafeterías, hoteles, restaurantes, hogares, etc.
- Fabricadas en acero inoxidable de máxima calidad, resistente y duradera.
- Pueden utilizarse tanto para líquidos calientes como fríos.
- Perfectas para espumar, calentar y servir la leche con el té o café.
- Boquilla vertedora para evitar goteos y un mango resistente al calor.
- Diseñadas para soportar altas temperaturas.
- Aptas para el lavavajillas.

FR

- Idéal pour les bars, les cafétérias, les hôtels, les restaurants, pour un usage domestique, etc.
- Fabriqué en acier inoxydable de la plus grande qualité, résistant et durable.
- Peut être utilisé aussi bien pour des liquides chauds que froids.
- Parfait pour mousser ou réchauffer et servir le lait avec le thé ou le café.
- Bec verseur anti-goutte et manche résistant à la chaleur.
- Conçu pour supporter de hautes températures.
- Aptes pour le lave-vaisselle.

EN

- Ideal for bars, cafés, hotels, restaurants, homes, etc.
- Manufactured in high-quality, strong and durable stainless steel.
- Can be used for both hot and cold liquids.
- Perfect for frothing or heating and serving milk with tea or coffee.
- Pouring spout to prevent dripping and heat-resistant handle.
- Designed to withstand high temperatures.
- Dishwasher safe.



**Lechera**  
Pot crémier · Milchkanne  
Milk jug · Leiteira

Ref	€	Color	L	e (mm)	U.Venta
A 58151	13,50	GREY	0,35	1	1
58152	16,10	GREY	0,60	1	1
B 58251	13,50	RED	0,35	1	1
58252	16,10	RED	0,60	1	1

**Lechera barista**  
Pot crémier pour baristas · Milchkanne für Baristas  
Barista milk jug · Leiteira barista

Ref	€	Color	L	e (mm)	U.Venta
A 58050	28,40	INOX	0,50	1	1
B 58150	31,30	GREY	0,50	1	1
C 58250	31,30	RED	0,50	1	1

# TETERA HIERRO

## Colección



ES

- Teteras fabricadas artesanalmente en hierro fundido de alta calidad muy resistentes.
- Incluyen infusor extraíble de acero inoxidable.
- Interior esmaltado para evitar la oxidación.
- Se recomienda hacer uso de un hervidor para calentar el agua y evitar así que pierda el color.

FR

- Thière fabriquée artisanalement en fonte d'aluminium de grande qualité, très résistante.
- Inclut un infuseur extractible en acier inoxydable.
- Intérieur émaillé pour éviter l'oxydation.
- Il est recommandé d'utiliser une bouilloire pour faire chauffer l'eau et ainsi éviter que la thière ne perde sa couleur.

EN

- This is a high quality, very resistant hand-made, cast iron tea pot.
- Includes a removable, stainless steel infuser.
- Interior is enameled to avoid rusting.
- It's recommended using a boiler to heat the water and thus keep it from losing its colour.

Red



White



Bamboo



Black



Green



Brown



Blue



**Tetera**  
Thière · Teekanne  
Tea pot · Bule

Ref	€	L	Color	U.Venta
68663	29,30	0,25	Red	1
68667	39,20	0,50	White	1
68666	32,70	0,60	Bamboo	1
68664	47,70	0,70	Black	1
68662	43,70	0,80	Green	1
68668	35,90	0,80	Brown	1
68661	40,50	1,10	Blue	1

# HERVIDOR SILVANTE

## Colección



ES

- Alto nivel de calidad y resistencia.
- Apto para hervir agua o calentar café preparado.
- Emite un ligero silbido cuando el agua hierve.

FR

- Haut niveau de qualité et de résistance.
- Apte pour faire bouillir de l'eau et réchauffer du café préparé.
- Émet un léger sifflement lorsque l'eau bout.

EN

- High level of quality and resistance.
- Suitable for boiling water or heating prepared coffee.
- Emits a gentle whistle when the water comes to the boil.



**Hervidor silbante**

Bouilloire sifflante · Flötenwasserkessel  
Whistling kettle · Chaleira com apito

Ref	€	L	U.Venta
68619	37,40	2,00	1
68627	39,40	2,50	1
68629	41,90	3,00	1
68639	43,30	4,00	1
68643	46,40	2,50	1
68644	46,40	2,50	1

# AGUA CALIENTE

## Dispensador



ES

- Ideal para oficinas, casas rurales, reuniones, etc.
- Fácil llenado. Depósito extraíble de gran capacidad (2 L) para llenar fácilmente el contenedor.
- Display intuitivo. Elige la cantidad de agua (150 ml - 230 ml- 300 ml) y la temperatura deseada (25°C - 70°C - 85°C - 95°C).
- Cuenta con función de bloqueo de seguridad.
- Ahorra tiempo y energía. Proporciona la cantidad exacta de agua caliente deseada, el agua restante del depósito se mantendrá fría.
- Bandeja de goteo extraíble e imantada, fácil de limpiar y colocar.

FR

- Idéal pour les bureaux, les gîtes ruraux, les réunions, etc.
- Remplissage facile. Réservoir extractible de grande capacité (2 L) pour remplir facilement le conteneur.
- Écran intuitif. Choisissez la quantité d'eau (150 ml - 230 ml- 300 ml) et la température souhaitée (25°C - 70°C - 85°C - 95°C).
- Dispose d'une fonction de blocage de sécurité.
- Gain de temps et économies d'énergie. Fournit la quantité exacte d'eau chaude souhaitée, l'eau restant dans le réservoir restera froide.
- Plateau d'écoulement extractible et aimanté, facile à nettoyer et à installer.

EN

- Perfect for offices, country homes, meetings, etc.
- Easy to fill. Large capacity (2 L) removable tank to easily fill the container.
- Intuitive display. Choose the amount of water (150 ml - 230 ml- 300 ml) and the desired temperature (25°C - 70°C - 85°C - 95°C).
- Includes safety lock feature.
- Save time and energy. Provides the exact amount of hot water desired, while the remaining water in the tank remains cold.
- Removable and magnetic drip tray, easy to clean and replace.

**Agua caliente en 5 segundos**  
Hot water in 5 seconds

**Bandeja de goteo extraíble e imantada**  
Removable and magnetic drip tray



**Dispensador de agua caliente**  
Distributeur d'eau chaude · Heißwasserspender  
Hot water dispenser · Dispensador de água quente

Ref	€	W	U.Venta	Ref	Tensión/Voltage	Potencia/Power	Capacidad/Cap.	Niveles Calentamiento Heating levels	Dispensado agua Water dispensed	Dimensiones/Sizes	Peso/Weight
69298	124,50	2400	1	69298	220-240 V / 50-60 Hz	2400 W	2,00 L	25°C - 70°C - 85°C - 95°C	150-230-300 ml	32x16,8x32,7 cm	2,50 Kg

# HERVIDORES DE AGUA

## Colección



### ES

- Hervidor de agua retro fabricado en acero inoxidable 18/10, acabado en gris mate.
- Permite calentar el agua de manera rápida y eficiente.
- Botón luminoso de encendido/apagado.
- Base independiente rotativa de 360°.
- Control STRIX, vida útil superior al controlador estándar. Protección contra el calentamiento en vacío muy preciso. Apagado automático.
- Visor de nivel de agua. Boquilla con filtro. Mango termorresistente.

### FR

- Bouilloire rétro fabriquée en acier inoxydable 18/10, finition gris mat.
- Permet de chauffer l'eau de façon rapide et efficace.
- Bouton lumineux de marche/arrêt.
- Base indépendante rotative à 360°.
- Contrôle STRIX, durée de vie utile supérieure au contrôleur standard. Protection contre la chauffe à vide très précis. Arrêt automatique.
- Visualisation du niveau d'eau. Buse avec filtre. Poignée thermo-résistante.

### EN

- Retro kettle made of 18/10 stainless steel with a matte grey finish.
- It can be used to heat water quickly and efficiently.
- Illuminated on/off button.
- Independent base rotates 360°.
- STRIX controller: useful life longer than a standard controller. Very precise protection against heating while empty. Automatic Shut-off.
- Water level viewer. Nozzle with filter. Heat-resistant handle.



**Base independiente rotativa de 360°**  
Independent base rotates 360°



**Botón luminoso de encendido/apagado**  
Illuminated on/off button



**Fácil llenado**  
Easy filling



**Interior inox 18/10**  
Interior 18/10 st. steel



**Boquilla con filtro**  
Nozzle with filter



**Indicador de nivel de agua**  
Water level indicator



### Hervidor de agua RETRO

Bouilloire électrique · Elektrische Wasserwamer  
Electric kettle · Chaleira eléctrica

Ref	€	W	L	U.Venta
69397	58,20	2200	1,7	1

Ref	Tensión/Voltage	Potencia/Power	Capacidad/Capacity	Dimensiones/Sizes	Peso/Weight
69397	220-240 V ; 50/60 Hz	2200 W	1,70 L	26x19,5x26,5 cm	1,20 Kg

Strix  
Technology



**Filtro extraíble antical**  
Removable anti-calc filter



**Visor de nivel de agua**  
Water level

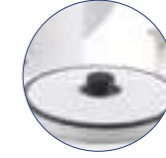

**Base rotativa de 360°**  
360° rotating base



**Calefactor oculto**  
Hidden heater



### Hervidor de agua

Bouilloire · Wasserwamer  
Kettle · Chaleira

Ref	€	Color	W	L	U.Venta
A 69590	22,60	GREY	2200	1,30	1
B 69591	22,60	WHITE	2200	1,30	1

Se desactiva cuando alcanza el nivel de temperatura deseada  
It is deactivated when it reaches the desired temperature level

Ref	Tensión/Voltage	Potencia/Power	Capacidad/Capacity	Dimensiones/Sizes	Peso/Weight
69590	220-240 V; 50/60 Hz	2200 W	1,30 L	20x15x21 cm	0,74 Kg
69591	220-240 V; 50/60 Hz	2200 W	1,30 L	20x15x21 cm	0,74 Kg

Strix  
Technology



### Hervidor de agua LAKE

Bouilloire · Wasserwamer  
Kettle · Chaleira

Ref	€	W	L	U.Venta
69277	59,70	2200	1,70	1

Ref	Tensión/Voltage	Potencia/Power	Capacidad/Capacity	Dimensiones/Sizes	Peso/Weight
69277	220-240 V; 50/60 Hz	2200 W	1,70 L (5 min)	23x16x23 cm	1,00 Kg
69291	220-240 V; 50/60 Hz	1630 W	1,00 L (3 min)	22x16x21 cm	1,10 Kg
69297	220-240 V; 50/60 Hz	2200 W	1,70 L (5 min)	22x18x23 cm	1,65 Kg



### Hervidor de agua RAPID

Bouilloire · Wasserwamer  
Kettle · Chaleira

Ref	€	W	L	U.Venta
69291	39,80	1630	1,00	1
69297	49,70	2200	1,70	1

**Protección de ebullición en seco**  
Dry boil protection



**Hervidor de agua**  
Bouilloire · Wasserwamer  
Kettle · Chaleira

Ref	€	W	L	U.Venta
69292	80,70	2200	1,70	1

- Base para conector de 360°.
- Se apagará automáticamente cuando el agua hierve.
- Elemento de calefacción oculto.
- Indicador de luz de encendido/apagado.
- La temperatura se puede ajustar de 50°C-95°C.
- Almacenamiento de cable.

- Base pour connecteur de 360°.
- S'éteint automatiquement lorsque l'eau bout.
- Élément de chauffe caché.
- Indicateur lumineux de marche / arrêt.
- La température peut être réglée entre 50°C et 95°C.
- Rangement du câble.

- Base for 360° connector.
- The wireless boiler will automatically switch off when the water boils.
- Hidden heating element.
- ON/OFF light.
- The temperature can be adjusted from 50°C - 95°C.
- Cable storage.



Ref	Tensión/Voltage	Potencia/Power	Temperatura/Temp.	Capacidad/Capacity	Dimensiones/Sizes	Peso/Weight
69292	220-240 V; 50 Hz	2200 W	50 - 95°C	1,70 L	23x23x32 cm	1,90 Kg



- Cuerpo cerámico, ecológico y resistente a altas temperaturas.
- Base independiente rotativa de 360°.
- Tapa extraíble con cierre.
- Indicador de capacidad máxima.
- Interruptor de encendido/apagado luminoso.
- Protección de sobrecalentamiento y funcionamiento en seco.
- Función de apagado automático.

- Corps céramique, écologique et résistant aux températures élevées.
- Base indépendante rotative à 360°.
- Couvercle extractible avec fermeture.
- Indicateur de capacité maximale.
- Interrupteur de marche/arrêt lumineux.
- Protection contre la surchauffe et fonctionnement à sec.
- Fonction d'arrêt automatique.

- Ceramic body, ecological and resistant to high temperatures.
- 360° rotating independent base.
- Removable lid with closure.
- Maximum capacity indicator.
- Light up on/off switch.
- Protection from overheating and dry running.
- Auto-off function.



**Interior inox 18/10. Calentamiento rápido**  
Interior 18/10 st. steel. Fast heating

Ref	€	Nombre	W	L	U.Venta
<b>A</b> 69276	51,70	GALA	1500	1,20	1
<b>B</b> 69289	56,50	GALA GREY	1200	1,00	1

Ref	Tensión/Voltage	Potencia/Power	Capacidad/Capacity	Dimensiones/Sizes	Peso/Weight
69276	220-240 V; 50/60 Hz	1500 W	1,2 L	24x17x25 cm	1,68 Kg
69289	220-240 V; 50/60 Hz	1200 W	1,0 L	23x16,5x23 cm	1,40 Kg

Termos - Botellas  
Thermos - Bottles



# POLIPROPILENO

## Jarras termo



ES

- Jarras termo que mantienen los líquidos calientes y fríos durante horas.
- Ideales para servir café, leche o té.
- Cuerpo de polipropileno, ligero y muy cómodo.
- Doble pared con una capa de vidrio en el interior que proporciona un alto rendimiento térmico.
- Tapa aislante de rosca con botón de apertura que mantiene el calor y dispensa fácilmente las bebidas.

FR

- Pichet isotherme qui maintient les liquides chauds et froids pendant des heures.
- Idéales pour servir le café, lait ou le thé.
- Corps en polypropylène, léger et très pratique.
- Double paroi avec ampoule en de verre à l'intérieur qui confère un haut rendement thermique.
- Couvercle isolant à vis avec poussoir d'ouverture qui maintient la chaleur et distribue facilement les boissons.

EN

- Thermos jug that keeps liquids hot and cold for hours.
- Ideal for coffee, milk or tea.
- Polypropylene body, light and very comfortable.
- Double skin with a glass layer inside to provide high thermal performance.
- Insulated screw cap with opening button for easy pouring and to keep the heat in the jug.



- Tapa aislante con pulsador.
- Irrompible, libre de malos olores.
- Fabricado en resina especial para soportar los golpes.
- Insulating lid with button.
- Shatterproof, free of bad smells.
- Manufactured in special resin to resist bangs.



### Jarra termo WOOD

Pichet thermo · Thermoskanne  
Termo jug · Jarra termo

Ref	€	cm	L	U.Venta
A 62598	22,10	Ø13x25,3	1,00	1
B 62599	22,10	Ø13x25,3	1,00	1

### Jarra termo

Pichet thermo · Thermoskanne  
Termo jug · Jarra termo

Ref	€	Color	L	U.Venta
A 62563	14,90	GREY	1,00	1
62564	17,00	GREY	1,50	1
62575	14,70	WHITE	1,00	1
B 62579	17,00	WHITE	1,50	1

### Jarra termo PUSH

Pichet thermo · Thermoskanne  
Termo jug · Jarra termo

Ref	€	L	U.Venta
62496	27,10	0,60	1
62491	38,80	1,20	1
62492	48,80	2,00	1

# INOX 18/10

## Jarras termo



ES

- Jarras termo que mantienen los líquidos calientes y fríos durante horas.
- Ideales para servir café, leche o té.
- Interior y exterior en acero inoxidable de gran calidad.
- Doble pared que proporciona un alto rendimiento térmico.
- Boca amplia; facilita su llenado y su limpieza.
- Tapa aislante de rosca con botón de apertura que mantiene el calor y dispensa fácilmente las bebidas.

FR

- Pichet isotherme qui maintient les liquides chauds et froids pendant des heures.
- Idéales pour servir le café, lait ou le thé.
- Intérieur et extérieur en acier inoxydable de grande qualité.
- Double paroi qui confère un haut rendement thermique.
- Bec large : facilite son remplissage et son nettoyage.
- Couvercle isolant à vis avec poussoir d'ouverture qui maintient la chaleur et distribue facilement les boissons.

EN

- Thermos jug that keeps liquids hot and cold for hours.
- Ideal for coffee, milk or tea.
- High-quality stainless steel interior and exterior.
- Double wall that provides high thermal performance.
- Wide mouth makes it easy to fill and clean.
- Insulated screw cap with opening button for easy pouring and to keep the heat in the jug.



### Jarra termo SUITE

Verseuse isothermo · Thermoskanne, idoliert  
Vacuum flask · Servidor termo

Ref	€	L	U.Venta
62522	49,90	1,6	1
62523	55,00	2,2	1



### Jarra termo QUICK

Bouteille thermo · Thermoskanne  
Insulated server · Jarra termo Luxe

Ref	€	L	U.Venta
62430	55,70	0,30	1
62460	61,70	0,60	1
62410	68,20	1,00	1
62415	87,90	1,50	1

Termo Hermético  
Hermetic cap



### Jarra termo LUXE

Bouteille thermo · Thermoskanne  
Insulated server · Jarra termo

Ref	€	L	U.Venta
63360	67,00	0,60	1
63310	72,90	1,00	1
63315	84,20	1,50	1
63320	89,80	2,00	1



### Jarra termo WHITE & BLACK

Verseuse isothermo · Thermoskanne, idoliert  
Vacuum flask · Servidor termo

	Ref	€	Color	L	U.Venta
A	62483	31,20	Blanco / White	1,00	1
B	62484	31,20	Negro / Black	1,00	1



### Jarra termo POT

Verseuse isothermo · Thermoskanne, idoliert  
Vacuum flask · Servidor termo

	Ref	€	L	h (mm)	U.Venta
	62481	29,70	1,00	160	1
	62485	35,10	1,50	200	1
	62486	36,10	2,00	220	1

HINWEIS : In Deutschland nicht verfügbar

Boca ancha para cubitos hielo  
Wide mouth for ice cubes



Doble pared  
Double wall

Inox

### Air pot

Air pot · Getränkespender, isoliert  
Air pot · Air pot

	Ref	€	L	h (cm)	U.Venta
	62472	69,60	2,50	32,5	1
	62473	75,50	3,00	34,5	1
	62475	101,20	4,00	39,0	1



### Termo BALA INOX

Thermo pour liquides · Thermobehälter für Flüssigkeiten  
Thermo for liquids · Termo para líquidos

	Ref	€	L	h (cm)	U.Venta
	62441	12,00	0,35	20,0	1
	62442	13,70	0,50	24,8	1
	62443	18,50	0,75	29,8	1
	62444	19,90	1,00	33,7	1

NO UTILIZAR CON BEBIDAS GASEOSAS, CALDOS NI LÁCTEOS  
DO NOT USE WITH FIZZY DRINKS, BROTHS OR DAIRY



- Mantiene las bebidas calientes o frías durante 24 horas.
- Doble pared que proporciona un alto rendimiento térmico.
- Ligero e irrompible.
- Boca ancha para cubos de hielo.
- Fácil de abrir y cerrar. Fácil limpieza.
- Maintient les boissons chaudes ou froides pendant 24 heures.
- Double paroi qui confère un haut rendement thermique.
- Léger et incassable.
- Bec large pour glaçons.
- Ouverture et fermeture faciles. Facile a nettoyer.
- Keeps drinks hot or cold for 24 hours.
- Double wall that provides high thermal performance.
- Light and shatterproof.
- Wide mouth for ice cubes.
- Easy to open and close. Facile a nettoyer.



- Mantiene las bebidas calientes o frías hasta 24 horas.
- Doble pared y cámara de vacío.
- Alto rendimiento térmico.
- Maintient les boissons chaudes ou froides jusqu'à 24 heures.
- Haut rendement thermique.
- Double paroi et chambre à vide.
- Keeps drinks hot or cold up to 24 hours.
- High thermal efficiency.
- Double wall and vacuum chamber.

# ALIMENTOS

## Termo

Inox 18/10



ES

- Cierre hermético: tapa de rosca con junta de silicona para evitar derrames.
- Alto rendimiento térmico gracias a su doble pared y a la cámara de vacío del contenedor: mantiene la comida caliente hasta 6 horas y fría hasta 8 horas.
- Sistema de boca extra ancha: facilita el llenado y la toma de los alimentos.
- Revestimiento exterior en color mate antiralladura (62635/62636).
- Materiales atóxicos, 100% libres de BPA.

FR

- Fermeture hermétique : couvercle à vis avec joint en silicone pour éviter les écoulements.
- Haut rendement thermique grâce à sa double paroi et à la chambre à vide du conteneur : maintient la nourriture chaude jusqu'à 6 heures et froide jusqu'à 8 heures.
- Système d'ouverture extra large : facilite le remplissage et la récupération des aliments.
- Finition extérieure noire mate anti-rayures.
- Matériaux non toxiques, 100% sans BPA.

EN

- Airtight seal: screw lid with silicone gasket to prevent spillage.
- High thermal performance thanks to the container's double wall and vacuum chamber: it keeps food hot for up to 6 hours and cold for up to 8 hours.
- Extra wide mouth system: makes it easy to fill and eat food.
- Anti-scratch exterior coating in matt colour.
- 100% BPA free non-toxic materials.



### Termo para alimentos FLORA

Thermo pour aliments · Thermobehälter für Speisen  
Thermo for food · Termo para alimentos

	Ref	€	Ø (cm)	h (cm)	L	U.Venta
A	62635	13,50	8,5	14,5	0,36	1
B	62636	23,60	10,5	15,0	0,50	1

### Termo para alimentos INOX

Thermo pour aliments · Thermobehälter für Speisen  
Thermo for food · Termo para alimentos

	Ref	€	L	h (cm)	U.Venta
	62448	20,90	0,70	19,7	1
	62440	25,00	1,00	23,5	1



### Termo p/alimentos SOFT TOUCH

Thermo pour aliments · Thermobehälter für Speisen  
Thermo for food · Termo para alimentos

	Ref	€	h (cm)	L	U.Venta
	62480	52,10	18	1,50	1

# BOTELLAS & VASOS

## Colección



### ES

- Fabricadas en acero inoxidable 18/10 de la mejor calidad.
- Doble pared de aislamiento, no transmiten el calor o el frío.
- Tapón de rosca hermético, a prueba de filtraciones y antiderrames.
- No transmiten sabores ni olores.
- Libres de BPA.

### FR

- Fabriquées en acier inoxydable 18/10 de la plus grande qualité.
- Double paroi isolante, ne transmet ni la chaleur ni le froid.
- Bouchon à vis hermétique, anti écoulements.
- Ne transmettent ni les goûts ni les odeurs.
- Sans BPA.

### EN

- Made of 18/10 stainless steel of the best quality.
- Double insulation wall, does not conduct heat or cold.
- Leak and spill proof hermetic screw on lid.
- Doesn't transmit flavours or odours.
- BPA free.

Acabado exterior con proceso de revestimiento en polvo  
Outside finished with powder coating process



### Botella inox EDAN

Bouteille inox · Stahlflasche  
Stainless steel bottle · Garrafa de aço inoxidável

	Ref	€	L	U.Venta
	62536	11,10	0,26	1
<b>A</b>	62537	12,10	0,50	1
	62538	15,00	0,75	1
	62546	11,10	0,26	1
<b>B</b>	62547	12,10	0,50	1
	62548	15,00	0,75	1
	62584	11,10	0,26	1
<b>C</b>	62585	12,10	0,50	1
	62586	15,00	0,75	1
	62587	11,10	0,26	1
<b>D</b>	62588	12,10	0,50	1
	62589	15,00	0,75	1

Tapón de madera con anilla para colgar  
Wood stopper with a ring for hanging



### Botella inox FLORA

Bouteille inox · Stahlflasche  
Stainless steel bottle · Garrafa de aço inoxidável

Ref	€	L	U.Venta
62556	14,10	0,50	1
62559	15,70	0,75	1



### Botella termo infusora FLORA

Bouteille thermos avec infuseur · Thermo-Teebereiter  
Infuser thermo bottle · Garrafa termo com infusor

Ref	€	Ø (cm)	h (cm)	ml	U.Venta
62534	15,30	6,6	21,5	350	1



### Vaso SERVE & GO

Timbale · Trinkbecher  
Tumbler · Copo

	Ref	€	Ø (cm)	h (cm)	ml	U.Venta
<b>A</b>	63138	14,60	9	14,0	280	1
<b>B</b>	63139	16,60	9	17,0	450	1

Tapón con doble protección a prueba de goteo  
Drip proof double protected lid



Correa de transporte resistente  
Strong carrying strap

### Botella personal ENERGY

Personnelle bouteille · Persönliche Flasche  
Personal bottle · Garrafa pessoal

Ref	€	L	U.Venta
61950	13,90	0,50	1
61965	15,10	0,65	1

- Fabricado en vidrio borosilicato de doble pared de máxima calidad.
- Filtro infusor de acero inoxidable 18/10 extraíble con asa que facilita la extracción.
- Cierre hermético: tapa de rosca fabricada en bambú con junta de silicona. Libre de BPA. 100% a prueba de fugas.
- Diseñado para hacer infusiones, té y bebidas frías.
- 100% sabor y aroma. No transmite olores ni sabores.
- Resistente al contraste térmico.
- Fácil limpieza: apto para el lavavajillas (excepto la tapa).

- Fabriquée en verre borosilicate à double paroi de la plus grande qualité.
- Filtre infuseur en acier inoxydable 18/10 extractible avec poignée qui facilite l'extraction.
- Fermeture hermétique : couvercle à vis fabriqué en bambou avec joint en silicone. Sans BPA. 100% anti-fuites.
- Conçue pour des infusions, du thé et des boissons froides. 100% goût et arôme.
- Ne transmet ni les odeurs ni les goûts.
- Résistante aux contrastes thermiques.
- Facile à nettoyer : apte pour le lave-vaisselle (sauf le couvercle).

- Made of the highest quality double-walled borosilicate glass.
- Removable 18/10 stainless steel infuser filter with handle for easy removal.
- Airtight closure: screw cap made of bamboo with silicone seal. BPA free. 100% leak proof.
- Designed to make herbal teas, teas and cold drinks.
- 100% flavor and aroma. Doesn't transmit aromas or flavors.
- Resistant to thermal contrast.
- Easy cleaning: dishwasher safe (except lid).

- Vaso reutilizable fabricado en vidrio borosilicato de gran espesor.
- Tapa de polipropileno con pestaña deslizante, libre de BPA.
- Cierre hermético; 100% a prueba de fugas.
- Banda de silicona antideslizante para un agarre seguro.
- Higiénico y resistente al contraste térmico.
- Diseñado para disfrutar de bebidas calientes o frías para llevar.
- No absorbe olores ni sabores.
- Fácil limpieza; apta para el lavavajillas.

- Verre réutilisable fabriqué en verre borosilicate de grande épaisseur.
- Couvercle en polypropylène avec bec coulissant, sans BPA.
- Fermeture hermétique ; 100% antifuites.
- Bande en silicone antidérapante pour une prise en main sûre.
- Hygiénique et résistant aux contrastes thermiques.
- Conçu pour profiter de boissons chaudes ou froides à emporter.
- N'absorbe ni les odeurs ni les goûts.
- Nettoyage facile ; apte pour le lave-vaisselle.

- This reusable glass is made of very thick borosilicate glass.
- It has a BPA free polypropylene lid with a sliding tab.
- Hermetic Seal: 100% leak proof.
- It has a non-slip silicone band for a secure grip.
- It's hygienic and resistant to thermal shock.
- It doesn't absorb odours or flavours.
- Easy to Clean: dishwasher safe.

# FUNDAS

## Colección

Tela **OEKO-TEX®**  
Cloth **STANDARD 100**  
FSC  
dishwasher



### ES

- Funda térmica; enfria y mantiene la temperatura durante más tiempo.
- Se adapta a todo tipo de botellas.
- Cubre prácticamente toda la botella, desde la base hasta al cuello.
- Meter la funda térmica en el congelador antes de su uso.
- El gel refrigerante no es tóxico.
- Para lavarlo, utilizar un paño húmedo. No apto para el lavavajillas.

### FR

- Housse thermique qui permet de refroidir et de maintenir la température idéale du vin ou du cava pendant plus longtemps.
- S'adapte parfaitement à tout type de bouteilles.
- Couvre pratiquement toute la bouteille, de la base au goulot.
- Mettez le housse thermique dans le congélateur avant utilisation.
- Le liquide de refroidissement n'est pas toxique.
- Pour la laver, utiliser un chiffon humide. Ne pas mettre au lave-vaisselle.

### EN

- Insulated cover for keeping wine or cava cool and at the perfect temperature for more time.
- Sides fit all kinds of bottles perfectly.
- It covers practically the whole bottle from the neck to the base.
- Put the thermal cover in the freezer before use.
- The coolant is non toxic.
- Use a damp cloth to clean it. Not dishwasher safe.



### Funda enfriabotellas

Housse de refroidissement de bouteilles · Flaschenkühler  
Bottle cooler cover · Arrefecedor de garrafas

	Ref	€	cm	Color	U.Venta
A	62276	14,70	15x23	DENIM	1
B	62277	14,70	15x23	BLACK	1
C	62270	14,70	15x23	BURDEOS	1
D	62288	14,30	15x23	NAVY	1



### Funda enfriabotellas

Housse de refroidissement de bouteilles · Flaschenkühler  
Bottle cooler cover · Arrefecedor de garrafas

	Ref	€	U.Venta
A	62325	10,60	6
B	62355	11,30	6

Bar - Bodega  
Bar - Wine cellar

# CUBITERAS

## Colección



**New**



32  
Cubitos  
Ice cubes

**Cubitera de silicona flexible. Fácil de desmoldar**  
Flexible silicone ice cube tray Easy to unmould

### Cubitera GLACIER

Bac à glaçon · Eismwürfelschale  
Ice cube tray · Cuvete para gelo

Ref	€	Cubitos	Cubito (cm)	cm	h (cm)	U.Venta
63336	16,40	32	2,5x2,5x1,8	22,5x12	10,5	1

- Cubitera de hielo fabricada en silicona de grado alimenticio.
- Capacidad para hacer 32 cubitos de hielo 2,4x2,4x1,8cm de tamaño.
- Contenedor fabricado en polipropileno para almacenar hasta 96 cubitos.
- Evita que los hielos adquieran sabores u olores. Incluye 2 tapas para tapar la cubitera y el contenedor de manera simultanea.
- Gracias a su gran flexibilidad y prácticamente sin esfuerzo, podrás sacar los cubitos de forma rápida y sencilla.
- Libre de BPA.

- Bac à glaçons fabriqué en silicone alimentaire.
- Capacité pour faire 32 glaçons d'une taille de 2,4x2,4x1,8 cm.
- Conteneur fabriqué en polypropylène pour accueillir jusqu'à 96 glaçons.
- Évite aux glaçons de récupérer des goûts ou des odeurs. Inclut 2 couvercles pour fermer simultanément le bac à glaçons et le conteneur.
- Grâce à sa grande flexibilité, les glaçons pourront être retirés de façon rapide et simple, presque sans efforts.
- Sans BPA.

- Ice cube tray made of food grade silicone.
- Capacity for making 32 2.4x2.4x1.8 cm ice cubes.
- Container made of polypropylene for storing up to 96 ice cubes.
- Keeps the ice cubes from taking on flavours or odours. Includes 2 lids for covering the ice cube tray and the container at the same time.
- You can get the ice cubes out quickly and easily and almost effortlessly because it's extremely flexible.
- BPA free.

**New**

Orificio para un llenado fácil  
Orifice for easy filling



16  
Cubitos  
Ice cubes



### Cubitera FRESH

Bac à glaçon · Eismwürfelschale  
Ice cube tray · Cuvete para gelo

Ref	€	Cubitos	Cubito (cm)	cm	h (cm)	U.Venta
63337	4,30	16	4,5x3x3	30x11,5	4,6	1

- Cubitera de hielo fabricada en polipropileno.
- Capacidad para hacer 16 cubitos de hielo.
- Evita que los hielos adquieran sabores u olores gracias a su tapa hermética.
- La tapa incluye un orificio para un llenado fácil sin derrames o salpicaduras.
- Libre de BPA.

- Bac à glaçons fabriqué en polypropylène.
- Capacité pour faire 16 glaçons
- Évite aux glaçons de récupérer des goûts ou des odeurs grâce à son couvercle hermétique.
- Le couvercle comprend un trou pour faciliter le remplissage sans renverser ou éclabousser.
- Sans BPA.

- Ice cube tray made of polypropylene.
- Capacity for making 16 ice cubes.
- Keeps the ice cubes from taking on flavours or odours thanks to its hermetic lid.
- The lid includes a hole for easy filling without spilling or splashing.
- BPA free.

**New**

Orificio para un llenado fácil  
Orifice for easy filling



15  
Cubitos  
Ice cubes



**Cubitera de silicona flexible. Fácil de desmoldar**  
Flexible silicone ice cube tray Easy to unmould

### Cubitera ICE

Bac à glaçon · Eismwürfelschale  
Ice cube tray · Cuvete para gelo

Ref	€	Cubitos	Cubito (cm)	cm	h (cm)	U.Venta
63338	8,50	15	3x3x2,5	20x11,5	3,5	1

- Cubitera de hielo fabricada en silicona.
- Capacidad para hacer 15 cubitos de hielo.
- Evita que los hielos adquieran sabores u olores gracias a su tapa hermética.
- La tapa incluye un orificio para un llenado fácil sin derrames o salpicaduras.
- Gracias a su gran flexibilidad y prácticamente sin esfuerzo, podrás sacar los cubitos de forma rápida y sencilla.
- Libre de BPA.

- Bac à glaçons fabriqué en silicone.
- Capacité pour faire 15 glaçons
- Évite aux glaçons de récupérer des goûts ou des odeurs grâce à son couvercle hermétique.
- Le couvercle comprend un trou pour faciliter le remplissage sans renverser ou éclabousser.
- Grâce à sa grande flexibilité, les glaçons pourront être retirés de façon rapide et simple, presque sans efforts.
- Sans BPA.

- Ice cube tray made of silicone.
- Capacity for making 15 ice cubes.
- Keeps the ice cubes from taking on flavours or odours thanks to its hermetic lid.
- You can get the ice cubes out quickly and easily and almost effortlessly because it's extremely flexible.
- The lid includes a hole for easy filling without spilling or splashing.
- BPA free.

**New**

6  
Cubitos  
Ice cubes



**Cubitera de silicona flexible. Fácil de desmoldar**  
Flexible silicone ice cube tray Easy to unmould

### Cubitera ICE XL

Bac à glaçon · Eismwürfelschale  
Ice cube tray · Cuvete para gelo

Ref	€	Cubitos	Cubito (cm)	cm	h (cm)	U.Venta
63339	8,10	6	4,5x4,5x4,5	15,5x10,5	4,5	1

- Cubitera de hielo fabricada en silicona.
- Capacidad para hacer 6 cubitos de hielo XL.
- Mantiene las bebidas frías durante más tiempo.
- Gracias a su gran flexibilidad y prácticamente sin esfuerzo, podrás sacar los cubitos de forma rápida y sencilla.
- Libre de BPA.

- Bac à glaçons fabriqué en silicone.
- Capacité pour faire 6 glaçons XL.
- Garde les boissons plus froides plus longtemps.
- Grâce à sa grande flexibilité, les glaçons pourront être retirés de façon rapide et simple, presque sans efforts.
- Sans BPA.

- Ice cube tray made of silicone.
- Capacity for making 6 XL ice cubes.
- Keeps drinks cold for longer.
- You can get the ice cubes out quickly and easily and almost effortlessly because it's extremely flexible.
- BPA free.

# ENFRIABOTELLAS INOX

## Colección

Inox  
18/10  
Dishwasher



ES

- Amplia gama de enfriadores de botellas para el vino o champán.
- Fabricados en acero inoxidable de gran calidad.
- Ideal para uso doméstico y profesional.

FR

- Large gamme de rafraîchisseurs de bouteilles pour le vin ou le champagne.
- Fabriqué en acier inoxydable de haute qualité.
- Idéal pour un usage domestique et professionnel.

EN

- Wide range of bottle coolers for wine or champagne.
- Made of high quality stainless steel.
- Ideal for domestic and professional use.

Compatible con:  
Compatible with:

62315  
62320  
62322  
62321  
61321  
61319  
14121  
62365  
62362  
65418  
65420  
65618  
65620



### Pie porta-cubos

Porte-seau à champagne · Sektkühlerständer  
Wine cooler stand · Pé porta baldes

Ref	€	Ø (cm)	h (cm)	U.Venta
62300	90,00	20	65	1

Sujeción segura y estable  
en cualquier mesa  
Secure and stable  
hold on any table



### Soporte de mesa enfriabotellas

Support seau à champagne · Tischhalterung für Sektkühler  
Wine cooler table support · Suporte balde de gelo arrefecedor

Ref	€	Ø (cm)	U.Venta
62478	12,80	18	1
62479	12,90	20	1

Apta para la mayoría de las  
botellas de vino o champán  
Fits most bottles of red wine  
or champagne

Doble pared aislante  
Double insulating wall



### Enfriabotellas INOX

Seau à champagne · Champagnerkühler  
Champaing cooler · Arrefecedora de garrafas

Ref	€	Ø (cm)	h (cm)	U.Venta
62389	31,00	10,5	19,5	1

Doble pared aislante  
Acabado SOFT TOUCH  
Double insulating wall  
SOFT TOUCH finish



### Enfriabotellas BLACK

Seau à vin · Champagnerkühler  
Vine bucket · Balde enfria-garrafas

Ref	€	Ø (cm)	Ø Int. (cm)	h (cm)	U.Venta
62356	16,50	12,5	9,50	20	1



garinox®

### Cubitera

Seau à glace · Sektkühler  
Ice bucket · Porta-cubos de gelo

Ref	€	Ø (cm)	h (cm)	L	U.Venta
62315	31,70	14	12,0	1,20	1
62320	43,10	20	19,0	4,50	1
62322	51,80	22	20,0	5,50	1
14121	19,20	20	20,0	4,00	1
62321	63,10	18	20,0	5,50	1
61321	24,60	20	21,0	4,25	1
61319	26,70	20	22,0	4,75	1



### Champanero

Rafraîchisseur à champagne · Champagnerkühler  
Champagne cooler · Champanheiro

Ref	€	Ø (cm)	h (cm)	L	U.Venta
62336	131,20	36	28,0	11,50	1
62436	121,30	36	23,0	11,50	1
62439	132,40	40	26,0	15,00	1
62346	86,00	36	20,5	13,00	1
62271	58,20	43x30	20,0	20,00	1
62272	70,10	53x38	25,0	27,00	1
62273	82,00	61x43	28,0	32,00	1

# MOON

## Colección

Inox  
18/10

ES

- **Cuerpo de Acero inoxidable 18/10, resistente a la corrosión.**
- **Diseño elegante y actual.**
- **Muy cómodo y fácil de desplazar gracias a su asa de cuero.**
- **Asa de piel vacuno acabado en curtido vegetal de 3 mm de grosor.**
- **Acabado exterior negro mate e interior lijado o exterior e interior lijado.**

FR

- **Corps en acier inoxydable 18/10, résistant à la corrosion.**
- **Style élégant et actuel.**
- **Très pratique et facile à déplacer grâce à sa anse en cuir.**
- **Anse en peau de vachette avec un tannage végétal de 3 mm d'épaisseur.**
- **Finition extérieur noir mat et intérieur brossé ou extérieur et intérieur brossé.**

EN

- **18/10 corrosion resistant stainless steel body.**
- **It has an elegant and modern design.**
- **Leather handles make it very easy and comfortable to move around.**
- **The handle has a 3 mm thick vegetable-tanned cow leather finish.**
- **Matte black outside and brushed inside or brushed inside and outside.**



### Cubitera MOON

Seau à glace · Sektkühler  
Ice bucket · Porta-cubos de gelo

Ref	€	Ø (cm)	h (cm)	L	U.Venta
A 65414	40,00	14	12	1,5	1
B 65614	34,60	14	12	1,5	1



### Enfriabotellas MOON

Seau à champagne · Champagnerkühler  
Wine bucket · Arrefecedora de garrafas

Ref	€	Ø (cm)	h (cm)	L	U.Venta
A 65418	47,40	18	19,0	4,0	1
65420	56,60	20	19,5	5,6	1
65618	43,80	18	19,0	4,0	1
B 65620	52,60	20	19,5	5,6	1



### Champanero MOON

Refräichisseur à champagne · Champagnerkühler  
Champagne cooler · Champanheiro

Ref	€	Ø (cm)	h (cm)	L	U.Venta
A 65436	120,30	36	20,5	11,5	1
B 65636	120,30	36	20,5	11,5	1



Más visibilidad  
y accesibilidad  
More visibility  
and accessibility



### Champanero inclinado MOON

Refräichisseur à champagne incliné · Schräger Champagnerkühler  
Inclined champagne cooler · Champanheiro inclinado

Ref	€	Ø (cm)	h (cm)	L	U.Venta
A 65440	119,10	40	27	15	1
B 65640	119,10	40	27	15	1



### Barreño MOON

Bassine · Glattwanne  
Mirror cooler · Bacia

Ref	€	Ø (cm)	h (cm)	L	U.Venta
A 65450	105,40	50	21	30	1
B 65650	105,40	50	21	30	1

# ENFRIABOTELLAS ACRÍLICAS

## Colección

ASA  
Acrylic  
dishwasher  
BPA free

Acabado metalizado  
Metallic finish



ABS  
Classic

### Enfriabotellas ARTIC

Seau à champagne · Champagnerkühler  
Champaging cooler · Arrefecedora de garrafas

Ref	€	Ø (cm)	h (cm)	L	U.Venta
61331	19,60	20	25	3,50	1



### Enfriabotellas BOAT BLACK

Seau à champagne · Champagnerkühler  
Champaging cooler · Arrefecedora de garrafas

Ref	€	Base	Boca	h (cm)	L	U.Venta
A 62354	33,40	13,5x16	20,5x25,5	28,5	4,00	1
62367	34,70	16x12	27x20	20,0	3,00	1
B 62368	50,00	21x15,5	35x26,5	26,0	7,00	1



### Enfriabotellas

Seau à champagne · Champagnerkühler  
Champaging cooler · Arrefecedora de garrafas

Ref	€	Base	cm	h (cm)	L	U.Venta
A 62364	18,00	16	22x18	23,0	3,00	1
B 62365	33,30	13,5x16	20,5x25,5	28,5	4,50	1
C 62366	40,00	13,5x18,5	21,5x30,5	26,0	5,50	1



### Enfriabotellas BLOOM

Seau à champagne · Champagnerkühler  
Champaging cooler · Arrefecedora de garrafas

Ref	€	Ø (cm)	h (cm)	L	U.Venta
A 62362	12,60	22	21	3,50	1
B 62371	28,80	33	25	10,00	1



### Enfriabotellas BUBBLE

Seau à champagne · Champagnerkühler  
Champaging cooler · Arrefecedora de garrafas

Ref	€	cm	h (cm)	L	U.Venta
62373	30,30	47x29	23	13,00	1

# JARRAS

## Colección



### Jarra dispensadora

Pichet distributeur de boissons · Getränkespender  
Serving pitcher · Jarra dispensadora

	Ref	€	cm	h (cm)	L	U.Venta
A	61951	22,20	18x23	30,5	5,50	1
B	61955	7,70	19,5	18,5	-	1
C	61956	13,20	21,0	14,5	-	1

- Jarra dispensadora fabricada en cristal de máxima calidad.
- Perfecta para bebidas frías como agua, limonada, zumo, sangría, etc.
- Grifo integrado para servir la cantidad de bebida deseada directamente en el vaso.
- Ideal para buffet, área de reuniones, recepciones de hoteles, etc.
- Gran apertura que facilita su llenado y su limpieza.
- Tapa de acero con cierre hermético.
- Jarra apta para el lavavajillas.

- Pichet distributeur de boissons fabriqué en verre de la plus grande qualité.
- Parfait pour des boissons froides comme de l'eau, de la limonade, du jus de fruits, de la sangria, etc.
- Robinet intégré pour servir la quantité de boisson souhaitée directement dans le verre.
- Idéal pour les buffets, les salles de réunions, les réceptions dans les hôtels, etc.
- Grande ouverture qui facilite son remplissage et son nettoyage.
- Couvercle en acier avec fermeture hermétique.
- Pichet compatible avec le lave-vaisselle.

- This serving pitcher is made of top quality glass.
- It's perfect for cold drinks like water, lemonade, juice or sangria.
- It has a built-in spout for pouring the right amount of the drink into a glass.
- It's perfect for buffets, meeting rooms, hotel reception areas, etc.
- Its large opening makes it easy to fill and clean.
- It has a steel lid with a hermetic seal.
- The pitcher is dishwasher safe.

Tapa antiderrames  
Filtro infusor en el centro para frutas y verduras  
Non-spill lid  
Infusion filter in the centre for fruits and vegetables



### Jarra infusora CLEAR

Pichet infuseur · Tee-Zubereiter  
Infusion pitcher · Jarra infusionadora

Ref	€	cm	L	U.Venta
61954	30,80	19x16x29	2,40	1



**Desenroscar la tapa girándola en sentido anti-horario**  
Dévisser le couvercle dans le sens inverse des aiguilles d'une montre  
Unscrew the lid by turning it counter-clockwise

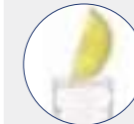

**Introducir la fruta, hierbas o semillas**  
Mettre de fruit, les herbes ou les graines  
Introduce the fruit, herbs or seeds

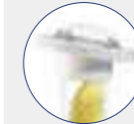

**Enroscar la tapa girándola en sentido horario**  
Revisser le couvercle en le faisant tourner dans le sens des aiguilles d'une montre  
Screw on the lid by turning it clockwise



**Introducir el filtro dentro de la jarra y presionar la tapa hasta cerrarla**  
Introduire le filtre dans le pichet et appuyer sur le couvercle jusqu'à sa fermeture  
Put the filter in the pitcher and push the lid until it's closed



Tapa con doble posición  
Filtro-colador integrado en la tapa (2)  
el hielo, las hierbas aromáticas  
o la fruta es retenida en el vertido

Double position lid  
Filter-strainer integrated in the lid (2).  
Ice, aromatic herbs or fruit is held  
in place while pouring

- Resistente a los choques térmicos.
- Perfecta para bebidas calientes o frías como limonadas, té, sangría, leche, etc.
- Ideal para llevar las bebidas a la mesa o guardarlas en la nevera.
- Diseño moderno y elegante.
- Mango ergonómico y pico vertedor para evitar derrames.
- Gran apertura que facilita su llenado y su limpieza.
- Cuerpo apto para el lavavajillas.

- Résistant aux chocs thermiques.
- Parfait pour les boissons chaudes ou froides comme la limonade, le thé, la sangria, le lait, etc.
- Idéal pour apporter les boissons à table ou les conserver au réfrigérateur.
- Design moderne et élégant.
- Manche ergonomique et bec verseur pour éviter les écoulements.
- Grande ouverture qui facilite son remplissage et son nettoyage.
- Corps compatible avec le lave-vaisselle.

- It's resistant to thermal shock.
- It's perfect for hot or cold drinks, like lemonade, tea, sangria or milk.
- It's ideal for bringing drinks to the table or keeping them in the refrigerator.
- It has a modern and elegant design.
- It has an ergonomic handle and spout to prevent spills.
- Its large opening makes it easy to fill and clean.
- The body is dishwasher safe.



### Jarra

Pot à eau · Wasserkanne  
Water jug · Jarra

	Ref	€	cm	h (cm)	L	U.Venta
A	61952	16,20	14x9,2	27,3	1,70	1
B	61953	15,00	13,8x8,5	22,8	1,00	1



### Jarra de agua INOX

Pot à eau · AcrylKrug  
Water pitcher · Jarra

	Ref	€	Ø (cm)	L	U.Venta
	62716	25,30	12x16	1,50	1
A	62721	27,90	12x23	2,00	1
	62726	32,20	12x26,5	2,50	1
	62715	29,40	12x16	1,50	1
B	62720	30,70	12x23	2,00	1
	62725	34,70	12x26,5	2,50	1

Con retén  
With ice guard

Inox  
18/10

Con tapa  
With lid

ASA  
Acrylic

### Jarra de agua abombada

Pot à eau bombe · Wasserkanne  
Rounder water pitcher · Jarra bojuda

Ref	€	L	U.Venta
62702	47,90	2,00	1

### Jarra de agua CLEAR

Pot à eau · AcrylKrug  
Water pitcher · Jarra

	Ref	€	L	U.Venta
A	62391	36,20	2,80	1
	62392	13,90	2,00	1
B	62393	17,60	3,00	1



# VASOS TRITÁN

## Colección



Aptas para todos los soportes de copas LACOR  
Suitable for all LACOR cup holders



ES

- Fabricados en tritán transparente libre de BPA; material muy resistente que soporta altas temperaturas.
- Ligeros, versátiles y a prueba de roturas, perfectos para espacios exteriores donde la seguridad es importante.
- Su gran parecido visual al vidrio hace que sea sutil, elegante y de calidad, como un vaso de vidrio.
- Reutilizables, irrompibles y aptos para el lavavajillas.

FR

- Fabriqué en Tritan transparent sans bisphénol A; matériau très résistant qui supporte des températures élevées.
- Légers, versatiles et à l'épreuve de la casse, ils sont parfaits pour des espaces extérieurs où la sécurité est importante.
- Leur grande ressemblance visuelle avec le verre les rend subtils, élégants et de qualité, tel un authentique verre.
- Réutilisables, incassables et aptes pour le lave-vaisselle.

EN

- Manufactured in transparent BPA-free Tritan; high strength material that can withstand high temperatures.
- Lightweight, versatile and break-proof, perfect for outdoor areas where safety is important.
- With its subtle, elegant and quality material, it provides a great visual resemblance to glass.
- Reusable, unbreakable and dishwasher safe.



### Set 6 vasos

Set 6 verres · Set 6 gläser  
Set of 6 glasses · Conjunto de 6 copos

	Ref	€	Ø (cm)	h (cm)	ml	U.Venta	
A	63141	33,00	8,5	9,5	400	1	Whisky · Whisky
B	63142	58,20	8,0	22,5	700	1	Cerveza · Beer
C	63143	45,30	7,0	20,0	350	1	Vino blanco · White wine
D	63144	51,40	9,5	21,0	500	1	Vino tinto · Red wine
E	63145	66,80	8,5	14,5	500	1	Refresco · Soft drinks
F	63146	61,90	8,5	14,0	500	1	Cerveza · Beer
G	63147	48,90	8,0	10,0	350	1	Agua · Water
H	63148	35,00	6,5	11,0	300	1	Vaso para niño · Child glass
I	63149	51,00	4,5	22,5	150	1	Champán · Champagne

### Vaso

Timbale · Trinkbecher  
Tumbler · Copo

	Ref	€	Ø (cm)	h (cm)	L	U.Venta
A	63350	3,40	7,3	7,7	0,32	1
B	63351	3,40	7,3	7,7	0,32	1
C	62406	6,00	7,5	10,0	0,30	1



# SOPORTE COPAS

## Colección

FE Cromado

Hierro/Iron Chrome

ES

- Soporte que permite ahorrar espacio y almacenar las copas de forma ordenada.
- Se fija a la parte superior de un mueble, techo o cornisa permitiendo colocar las copas boca abajo y facilitando accesibilidad de las mismas.
- Desliza las copas muy fácilmente evitando que se marquen y que se rompan.

FR

- Support qui permet un gain de place et un rangement des verres à pied de façon ordonnée.
- Se fixe à la partie supérieure d'un meuble, d'un plafond ou d'une corniche, permettant ainsi de ranger les verres à pied vers le bas et faciliter leur accès.
- Fait glisser les verres très facilement en évitant qu'ils soient marqués et qu'ils se cassent.

EN

- With this rack, you can save space and store glasses in an organised way.
- It can be attached to the top of a piece of furniture, ceiling or moulding where the glasses are placed upside down for easy access.
- The glasses slide easily so they won't get scratched or broken.

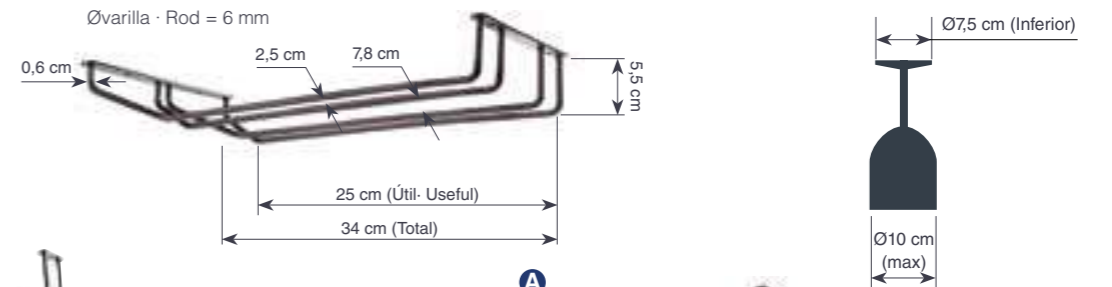

### Soporte de copas

Support à coupes · Gläserhalter  
Cups stand · Suporte de tapas

	Ref	€	cm	h (cm)	U.Venta
A	62261	14,90	34x10	6	1
B	62262	21,80	34x20	6	1
C	62263	33,50	34x40	6	1

### Soporte de copas BLACK

Support à coupes · Gläserhalter  
Cups stand · Suporte de tapas

	Ref	€	cm	h (cm)	U.Venta
A	62264	17,30	34x10	6	1
B	62265	26,60	34x20	6	1
C	62266	37,40	34x40	6	1

No requiere instalación  
Recubrimiento de silicona, no raya  
No installation required  
Silicone coating, does not scratch



Øvarilla · Rod = 6 mm

### Soporte de copas TRI

Support à coupes · Gläserhalter  
Cups stand · Suporte de tapas

	Ref	€	cm	Copas	U.Venta
	62267	18,10	31x21	6	1

Fijado a la pared  
Fastened to wall



Fijado al techo  
Fastened to ceiling



Øvarilla · Rod = 6 mm

### Soporte de copas DUE

Support à coupes · Gläserhalter  
Cups stand · Suporte de tapas

	Ref	€	cm	h (cm)	U.Venta
	62268	18,70	45x32	6,0	1

# COCTELERÍA

## Colección

Inox 18/10    Inox    PP Polypropilene    Dishwasher    BPA free

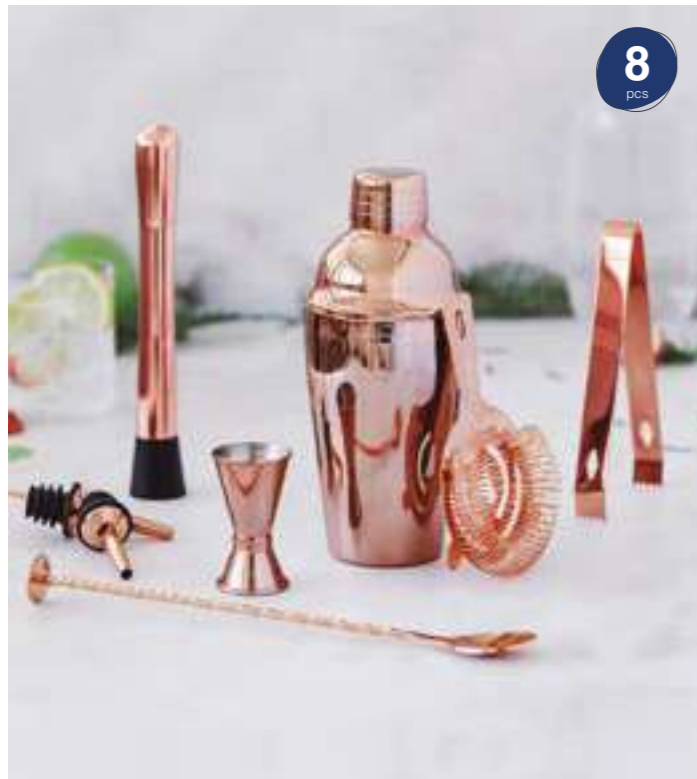

8 pcs



10 pcs

ES

- Todo lo necesario para preparar deliciosos cócteles.
- Ideal para profesionales de la coctelería.
- Podrá encontrar coctelera, pinzas para hielo, vasos medidores, cucharas de bar, etc.
- Fabricados en acero inoxidable de alta calidad.

FR

- Tout ce dont vous avez besoin pour préparer de délicieux cocktails.
- Idéal pour les mixologues professionnels.
- Vous pouvez trouver des shakers, pinces à glace, verres à mesurer, cuillères de bar, etc.
- Fabriqué en acier inoxydable de haute qualité.

EN

- Everything you need to prepare delicious cocktails.
- Ideal for professional mixologists.
- You can find cocktail shakers, ice tongs, measuring glasses, bar spoons, etc.
- Made of high quality stainless steel.

Compuesto por:

- A** Cucharilla cocktail
- B** Coctelera
- C** Maza mojito
- D** Colador gusanillo
- E** Sacacorchos
- F** Dosificador licor
- G** Pinza
- H** Tapón
- I** Dos boquillas servidoras
- J** Soporte

Compuesto por:

- A** Cucharilla cocktail
- B** Coctelera
- C** Maza mojito
- D** Colador gusanillo
- E** Pinza
- F** Dosificador licor
- G** Dos boquillas servidoras



### Juego coctelería INOX

Ensemble pour cocktails · Cocktail-Utilensilien  
Cocktail Set · Conjunto para preparar cocktails

Ref	€	Piezas	L (Coctelera)	ml (Medidor)	cm (Cuchara)	U.Venta
62181	59,80	10	0,55	15 / 30	26	1



### Juego coctelería INOX COBRE

Ensemble pour cocktails · Cocktail-Utilensilien  
Cocktail Set · Conjunto para preparar cocktails

Ref	€	Piezas	L (Coctelera)	ml (Medidor)	cm (Cuchara)	U.Venta
62182	56,00	8	0,55	15 / 30	26	1

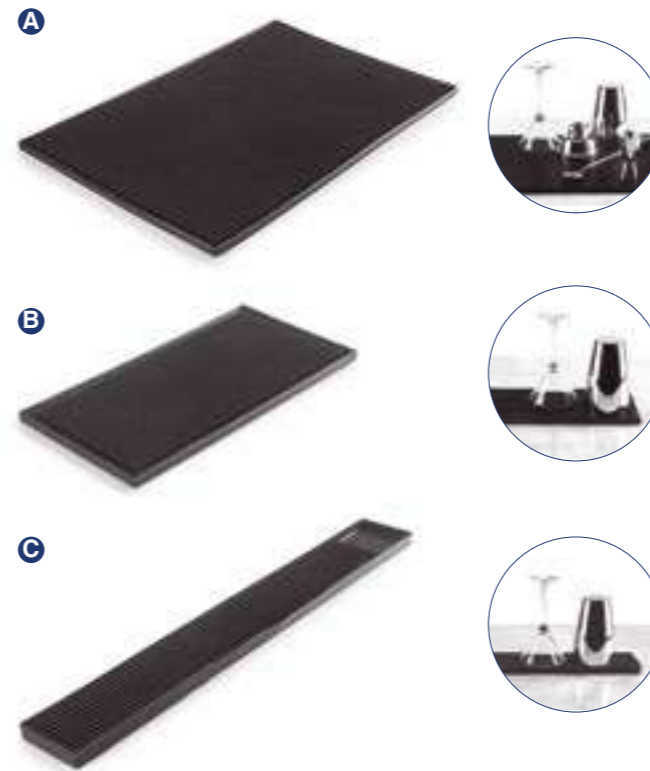

### Tapete para coctelería

Tapis pour égouttoir · Cocktail-Matte  
Cocktail mat · Tapete para cocktails

Ref	€	cm	h (cm)	U.Venta
<b>A</b> 62626	17,40	45x30	1,80	20
<b>B</b> 62627	10,70	30x15	1,80	20
<b>C</b> 62628	10,70	60x8	1,80	20

ABS plastic



Perfecto para organizar utensilios y accesorios de coctelería y bar como servilletas, pajitas, adornos, etc.  
Perfect for organising cocktail utensils and accessories and bar such as napkins, straws and decorations

Puede contener aproximadamente 100 servilletas de 12x12 cm  
It holds around 100 12x12 cm cocktail napkins



### Organizador de accesorios cóctel

Organisateur pour accessoires de cocktail · Organizer für Cocktailzubehör  
Cocktail accessory organiser · Organizador de acessórios para cocktails

Ref	€	cm	h (cm)	Compartimentos	U.Venta
62438	9,40	24x14	10	6	1

TPE plastic

Borde elevado  
Recoge los líquidos entre las púas  
Raised edge  
Collect liquids between the spikes

- Fabricado en caucho termoplástico de alta calidad en color negro.
- Grueso, flexible y duradero y libre de BPA.
- 100% Antideslizante, se adhiere muy bien a cualquier superficie.
- Diseñado para escurrir vasos, copas y utensilios al instante.
- Ayuda a mantener limpia la zona de la barra.
- Higiénicos y muy fáciles de limpiar. Aptos para el lavavajillas.

- Fabriqué en caoutchouc thermoplastique de grande qualité en couleur noire.
- Épais, flexible, durable et sans BPA.
- 100% antiadhésif, adhère parfaitement bien à n'importe quelle surface.
- Conçu pour égoutter les verres, les coupes et les ustensiles instantanément.
- Aide à garder propre l'espace du comptoir.
- Hygiénique et très facile à nettoyer. Apte pour le lave-vaisselle.

- Made of high quality black thermoplastic rubber.
- Thick, flexible, durable and BPA free.
- 100% non-slip, it sticks to any surface very well.
- Designed to dry cups, glasses and utensils instantly.
- Helps keep the bar area clean.
- Hygienic and very easy to clean. Dishwasher safe.

ABS plastic



Ideal para dar un toque especial a los cócteles.  
Consigue un efecto de hielo o escarcha  
Perfect for adding a special touch to your cocktails.  
Create a frosty or icy effect

Se pliega para un fácil almacenamiento  
Foldable for easy storage

Almohadilla para zumo  
Pad for juice



### Ribeteador de copas y vasos

Sucreur/saleur bordeur de verres · Umranden für Cocktailgläser  
Glass rimmer · Decorador de copos e taças

Ref	€	cm	h (cm)	Bandejas	U.Venta
62414	13,90	20x16	7,5	3	1

# New



## Taza MOSCOW MULE

Tasse · Tassen  
Cup · Copo

	Ref	€	Ø (cm)	h (cm)	ml	U.Venta
A	62184	10,00	9	9	480	1
B	62185	10,00	9	10	550	1

- Diseño vintage. Fabricada en acero inoxidable 18/10 de alta calidad. Revestimiento exterior cobre mate.
- Ideal para preparar el clásico coctel de vodka "Moscow Mule", cócteles o cualquier tipo de bebida frías.
- Mantiene las bebidas frías por más tiempo gracias a su alta conductividad térmica.
- Borde de acero encapsulado reforzado. Mango ergonómico fabricado en acero inoxidable.
- Fácil limpieza: Se recomienda lavar a mano y secar a fondo. No apto para el lavavajillas.

- Style vintage. Fabriqué en acier inoxydable 18/10 de grande qualité. Revêtement extérieur en cuivre mat.
- Idéales pour préparer le traditionnel cocktail de vodka « Moscow Mule », ainsi que tout type de cocktail ou de boisson froide.
- Gardent les boissons fraîches plus longtemps grâce à leur grande conductivité thermique.
- Bord en acier encapsulé renforcé. Manche ergonomique fabriqué en acier inoxydable.
- Nettoyage facile : Il est recommandé de les laver à la main et de parfaitement bien les sécher.
- Ne pas mettre au lave-vaisselle.

- Vintage design. Made of high quality 18/10 stainless steel. Matte copper outer finish.
- Perfect for making the classic "Moscow Mule" vodka cocktail, other cocktails or any kind of cold drink.
- Keeps drinks cold longer because of their high thermal conductivity.
- Reinforced encapsulated steel edge. Ergonomic handle made of stainless steel.
- Easy to clean: Hand washing and thorough drying is recommended. Not dishwasher safe.



## Coctelera BOSTON

Agitateur · Cocktailshaker  
Cocktail shaker · Agitador

	Ref	€	Ø (cm)	h (cm)	U.Venta
A	62285	13,90	8	16	1
B	62286	18,20	8	16	1



## Coctelera INOX

Agitateur · Cocktailshaker  
Cocktail shaker · Agitador

	Ref	€	L	U.Venta
	623031	50,80	0,50	1
	623041	60,30	0,75	1



## Coctelera ACRYLIC

Agitateur · Cocktailshaker  
Cocktail shaker · Agitador

	Ref	€	Ø (cm)	h (cm)	U.Venta
	62388	20,60	9	22,5	1

- Cuerpo fabricado en acero inoxidable de máxima calidad. Acabado mate.
- Doble pared aislante: aísla el hielo de la temperatura ambiente y lo mantiene sólido durante más tiempo. Evita la condensación exterior.
- Incluye tapa 100% de bambú natural y pinza para el hielo de acero inoxidable 18/10.
- Ideal para cubitos de hielo o hielo picado.
- Fácil de transportar: práctica y cómoda asa de acero inoxidable.

- Corps fabriqué en acier inoxydable de la plus grande qualité. Finition mate.
- Double paroi isolante : isole la glace de la température ambiante et la maintient solide plus longtemps. Évite la condensation extérieure.
- Inclut un couvercle 100% en bambou naturel et une pince à glaçons en acier inoxydable 18/10.
- Idéal pour les glaçons ou la glace pilée.
- Facile à transporter : poignée pratique en acier inoxydable.

- Made of top quality stainless steel. Matte finish.
- Double wall insulation : insulates the ice from the room temperature and keeps it solid for longer.
- Prevents external condensation.
- Includes 100% natural bamboo lid and 18/10stainless steel ice tongs.
- Ideal for ice cubes or crushed ice.
- Easy to carry: practical and comfortable stainless steel handle.



## Cubitera NORDIC

Seau à glace · Sektkühler  
Ice bucket · Porta-cubos gelo

	Ref	€	Ø (cm)	h (cm)	L	U.Venta
	65514	32,00	14	14,5	1,30	1



## Cubitera CLEAR

Seau à glace · Sektkühler  
Ice bucket · Porta-cubos gelo

Ref	€	Ø (cm)	h (cm)	L	U.Venta
62363	25,80	20	21	3,00	1



## Librador

Pelle à farine · Mehlshaufel  
Ice shovel · Corredor

Ref	€	ml	L (cm)	A (cm)	U.Venta
67012	17,40	60	19,0	5,0	6
67013	20,30	110	21,5	6,0	6
67014	23,90	200	24,0	7,0	6
67016	26,60	260	25,5	8,5	1
67017	29,50	360	29,0	10,0	6
67018	31,80	470	31,0	11,0	6
67019	39,60	640	35,0	12,5	6
67020	47,40	860	38,0	14,0	6

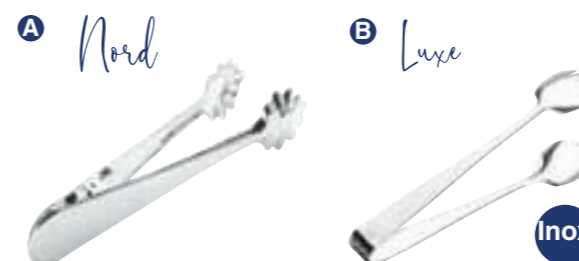

## Pinza de hielo

Pince à glace · Eiszange  
Ice tong · Pinça de gelo

	Ref	€	L (cm)	U.Venta
A	62306	4,60	18,5	12
B	62337	9,90	20,0	12



## Cargas para botellas sifón CO2

Cartuches CO2 pour siphon · CO2 -Kapsen für Siphon  
CO2 soda charges · Botijas de sifão CO2

	Ref	€	Botellas	g	U.Venta
	68602	8,00	10	8	1



## Picadora de hielo manual

Broyeur à glace manuel · Manuel Eis-Crusher  
Manual ice crusher · Picadora de gelo manual

Ref	€	cm	h (cm)	U.Venta
60327	49,30	16x23	12	1



## Librador

Pelle à farine · Mehlshaufel  
Ice shovel · Corredor

	Ref	€	ml	Mango (cm)	U.Venta
A	67021	5,70	170	12	1
B	67022	11,60	900	12	1
C	67023	15,90	1800	14	1



**Carga de CO2 para botellas de sifón. Una carga de aprox. 8 gr = 1Lt de soda. Un solo uso. Se suministra en caja de 10 unidades.**  
Loading CO2 in bottles with siphons. An (approximately) 8g load is sufficient for 1 l of soda. Single use. Supplied in 10-unit boxes

## Botella sifón CO2

Bouteille siphon · Soda-Siphon  
Soda maker bottle · Garrafa armadilha

	Ref	€	Ø (cm)	L	U.Venta
	68601	54,90	10x39	1,00	1

Inox  
18/10



4  
Botellas  
Bottles

### Dosificador licor DUAL

Mesure à cocktail · Cocktailmass  
Jigger · Dosificador licor

Ref	€	h (cm)	cl	U.Venta
A 62329	21,80	9,7	2-2,5 / 4-5	1
B 62330	20,10	9,7	2 / 4	1

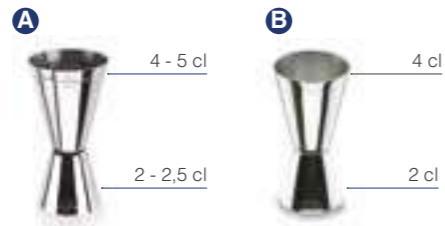

### Colador gusanillo

Passoire à cocktail · Cocktailsieb  
Cocktail strainer · Coador batidos

Ref	€	U.Venta
62326	23,60	1

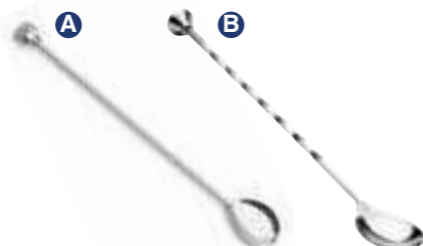

### Cucharilla cocktail

Cuillère cocktail · Barlöffel  
Cocktail spoon · Colher cocktail

Ref	€	L (cm)	U.Venta
A 62302	4,70	27	6
B 62352	8,10	28	6

PP  
Polipropileno



### Maza negra mojito

Pilon noir mojito · Mojitosößel  
Black mace mojito · Maço preto mojito

Ref	€	L (cm)	U.Venta
62278	11,20	18	1
62279	12,70	26	1

### Dispensador de líquidos BAR-BUTLER

Distributeur de boissons alcoolisées · Spirituosenspender  
Liquor dispenser · Dispensador de bebidas

Ref	€	L	U.Venta
62341	92,70	4 cl	1

# PARED

## Abrebotellas

ES

- Fabricado con aleación de zinc.
- Robusto y resistente.
- Fácil de montar, se fija en la pared con los tornillos incluidos.
- Fácil apertura con una sola mano.

FR

- Fabriqué avec un alliage de zinc.
- Robuste et résistant.
- Facile à installer, il se fixe au mur avec les vis incluses.
- Décapsulage facile d'une seule main.

EN

- Made with zinc alloy.
- Strong and sturdy.
- Easy to install; attaches to the wall with the included screws.
- Easy to open with just one hand.

Aleación de zinc

Zinc alloy



### Abrebotellas pared

Décapsuleur mural · Wandflaschenöffner  
Wall mounted bottle opener · Abridor de garrafas de parede

Ref	€	cm	U.Venta
63052	4,20	6x3x8	1



# VINOTECA

## Colección

Almacena hasta 6 botellas  
Stores up to six bottles

6  
Botellas  
Bottles



### Botellero

Casier à vin · Weinregal  
Vine rack · Cremalheira do vinho

Ref	€	cm	h (cm)	ØVarilla (mm)	U.Venta
61141	36,80	26,6x14	37,5	4	1

180°C

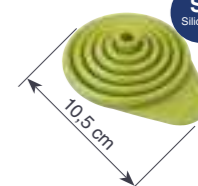

Si  
Silicone

### Embudo expandible

Entonnoir extensible · Trichter  
Foldable funnel · Funil extensível

Ref	€	Ø (cm)	H (cm)	U.Venta
68085	5,90	8	10,5	1

Inox



### Descapsulador ROND

Coupe capsule · Folien cutter  
Foil cutter · Descapsulador

Ref	€	Ø (cm)	U.Venta
63137	4,80	6	12

Inox



### Anilla antigoteo

Anneau stop gouttes à vin · Weinring Trop-Stop  
Wine drip stop ring · Anilha anti-gota

Ref	€	Ø (cm)	U.Venta
63019	3,10	5	12

Si  
Silicone



### Boquilla servidora + tapón

Bec verseur + bouchon · Ausgiess-Aufsatz mit Verschluss  
Spout for wine + rubber cap · Boquilha de servir + tampão

Ref	€	U.Venta
63022	4,40	12

Diseñado para oxigenar y ralentizar el flujo del vino garantizando un mejor aroma y potenciando los sabores de manera rápida y sencilla  
Designed to slow down the flow of wine, guaranteeing a better bouquet and enhancing flavours quickly and easily

Conserva durante más tiempo el frescor y el sabor del champán o cava  
Conserve the freshness and flavour of Champagne or Cava for longer

PMMA  
plastic

Si  
Silicone



### Aireador de vino

Aérateur de vin · Weinbelüfter  
Wine aerator · Arejador de vinho

Ref	€	U.Venta
63048	2,80	1

Inox

PP  
Polipropileno



ABS  
plastic



Bloqueo rotativo  
Rotary lock

### Tapón champán

Bouchon de champagne · Sektflaschenverschluss  
Campagne cap · Tampão champagne

Ref	€	Ø (cm)	h (cm)	U.Venta
A 63021	7,10	-	-	1
B 63055	8,00	3,8	3,5	1

# SACACORCHOS

## Colección



ES

- Diseño elegante, moderno y ergonómico: ideal para su uso profesional y de hogar.
- Funcionamiento rápido y sencillo tan solo pulsando un botón.
- Facilita la extracción del corcho de cualquier botella de vino en tan solo 6-8 segundos.
- Extrae el corcho suavemente y de forma silenciosa.
- Cabezal de extracción con iluminación led (63056 / 63057).
- Indicador de batería luminoso mediante LED: 4 niveles para indicar el nivel de energía (63056).
- Se carga mediante cable Micro USB.
- Incluye: cable cargador USB y descapsulador.

FR

- Style élégant, moderne et ergonomique : idéal pour une utilisation aussi bien professionnelle que domestique.
- Fonctionnement rapide et simple en appuyant simplement sur un bouton.
- Facilite l'extraction du bouchon en liège de n'importe quelle bouteille de vin en 6-8 secondes seulement.
- Extraie le bouchon en liège lentement et silencieusement.
- Tête d'extraction avec éclairage led (63056 / 63057).
- Indicateur de batterie lumineux via LED : 4 niveaux pour indiquer le niveau de batterie (63056).
- Se charge à l'aide d'un câble Micro USB.
- Inclut : câble chargeur USB et décapsuleur.

EN

- Smart, modern and ergonomic design - ideal for professional and home use.
- Quick and easy push-button operation.
- Removes the cork from any bottle of wine in just 6-8 seconds.
- Removes the cork gently and quietly.
- Extraction head with led lighting (63056 / 63057).
- Battery indicator led: 4 energy level indicators (63056).
- Charging by Micro USB cable.
- Included: USB charger and decapsulator.



Autonomía  
Battery life  
**30-40**  
Botellas  
Bottles

### Sacacorchos BLACK LUXE

Tire-bouchon · Korkenzieher  
Corkscrew · Saca-rolhas

Ref	€	Ø (cm)	h (cm)	U.Venta
63056	38,30	4,8	22	1



Autonomía  
Battery life  
**30-40**  
Botellas  
Bottles

### Sacacorchos BLACK

Tire-bouchon · Korkenzieher  
Corkscrew · Saca-rolhas

Ref	€	Ø (cm)	h (cm)	U.Venta
63057	29,60	5	19	1



Autonomía  
Battery life  
**30**  
Botellas  
Bottles

### Sacacorchos eléctrico AutoPro

Tire bouchon électrique · Korkenzieher, elektrisch  
Electric corkscrew · Saca-rolhas Eléctrico

Ref	€	W	cm	U.Venta
63031	40,70	1,2	Ø12x32	1



Autonomía  
Battery life  
**30-40**  
Botellas  
Bottles

### Sacacorchos eléctrico SMART

Tire bouchon électrique · Korkenzieher, elektrisch  
Electric corkscrew · Saca-rolhas Eléctrico

Ref	€	W	cm	U.Venta
63054	43,70	18	Ø5x25	1

Zamak  
Zinc alloy



### Sacacorchos profesional AUTOMATIC

Tire-bouchon professionnel · Profi-Entkorker  
Professional corkscrew · Saca-rolhas profissional

	Ref	€	U.Venta
A	63010	324,20	1
B	63012	337,40	1



### Sacacorchos BLACK

Tire-bouchon · Korkenzieher  
Zinc alloy corkscrew · Saca-rolhas

Ref	€	U.Venta
63028	45,90	1



### Sacacorchos VIN

Tire-bouchon · Korkenzieher  
Zinc alloy corkscrew · Saca-rolhas

Ref	€	U.Venta
63013	17,30	1



Multifunción 2 en 1  
Multi-purpose: 2 in 1

### Sacacorchos CLASSIC

Tire-bouchon · Korkenzieher  
Zinc alloy corkscrew · Saca-rolhas

Ref	€	U.Venta
63047	10,00	1

Multifunción 3 en 1:  
sacacorchos + abridor de botellas  
+ cuchilla corta cápsulas  
Multi-purpose: 3 in 1:  
corkscrew + bottle opener+ capsule cutter



Multifunción 3 en 1  
Multi-purpose: 3 in 1

Multifunción 3 en 1  
Multi-purpose: 3 in 1



### Sacacorchos camarero DUO

Tire-bouchon limonadier · Kellnerkorkezieher  
Waiter's corkscrew · Saca-rolhas con navalha

Ref	€	U.Venta
63018	5,30	6



### Sacacorchos camarero LUXE

Tire-bouchon limonadier · Kellnerkorkezieher  
Waiter's corkscrew · Saca-rolhas con navalha

Ref	€	U.Venta
63044	5,10	1



### Sacacorchos camarero MADERA

Tire-bouchon limonadier · Kellnerkorkezieher  
Waiter's corkscrew · Saca-rolhas con navalha

Ref	€	U.Venta
63046	7,50	1

# BOMBAS DE VACÍO

## Colección



- Fabricado en ABS de máxima calidad. Acabado color negro mate.
- Conserva el vino en perfecto estado manteniendo todo su sabor y aroma durante más tiempo.
- Extrae el aire acumulado en el interior de la botella y retrasa el proceso de oxidación.
- Fácil de usar: pulsando un solo botón.
- Ahorra tiempo: cierra la botella con el tapón y presiona el botón para extraer el aire en segundos.
- 100% hermético contra fugas.
- Hasta 60 ciclos de vacío en cada carga.
- Kit completo: incluye 2 tapones con indicador de fecha y cargador eléctrico.

- Fabriquée en ABS de la plus grande qualité et en finition de couleur noire mate.
- Conserve le vin en parfait état en maintenant tout son goût et son arôme plus longtemps.
- Extrait l'air accumulé à l'intérieur de la bouteille et retarde le processus d'oxydation.
- Facile à utiliser : appuyer sur un seul bouton.
- Gain de temps : fermer la bouteille avec le bouchon et appuyer sur le bouton pour extraire l'air en quelques secondes.
- 100% hermétique contre les fuites.
- Jusqu'à 60 cycles de vide à chaque charge.
- Kit complet : inclut 2 bouchons avec indicateur de date et base chargeur électrique.

- Made of high quality ABS plastic in a matte black finish.
- Keeps the wine in perfect condition, retaining all its flavour and aroma for much longer.
- Removes the air trapped inside the bottle and slows down the oxidation process.
- Easy to use: works at the press of a single button.
- Saves time: insert the stopper in the bottle and press the button to remove the air in seconds.
- 100% leak-proof.
- Up to 60 vacuum cycles per charge.
- Complete kit: includes 2 stoppers with date indicator and charging electric base.



Carga Charge  
**50**  
Ciclos de vacío Vacuum cycles

Base cargador eléctrico Charging electric base

Incluye 2 tapones con indicador de fecha Includes 2 caps with date indicator

### Bomba de vacío LUXE

Pompe à vide · Weinpumpe  
Vacuum pump · Bomba de vacío

Ref	€	Ø (cm)	h (cm)	U.Venta
63058	40,30	4,5	20	1



Inox



### Bomba de vacío KEEP

Pompe à vide · Weinpumpe  
Vacuum pump · Bomba de vacío

Ref	€	U.Venta
63051	8,90	1
A R63051A	2,30	1

### Bomba de vacío INOX

Pompe à vide · Weinpumpe  
Vacuum pump · Bomba de vacío

Ref	€	U.Venta
63033	11,20	1
A R63033	3,10	1

- Conserva el vino en perfecto estado manteniendo todo su sabor y aroma durante más tiempo.
- Extrae el aire acumulado en el interior de la botella y retrasa el proceso de oxidación.
- Cierra la botella con el tapón y bombea de 10 a 20 veces (dependiendo de la cantidad de vino que haya dentro de la botella) para establecer el vacío.
- Incluye bomba de vacío y dos tapones (con indicador de la fecha en la que se ha sellado la botella).

- Conserve le vin en parfait état en maintenant tout son goût et son arôme plus longtemps.
- Extrait l'air accumulé à l'intérieur de la bouteille et retarde le processus d'oxydation.
- Refermez la bouteille avec le bouchon et pompez de 10 à 20 fois (selon la quantité de vin à l'intérieur de la bouteille) pour faire le vide.
- Inclut une pompe à vide et deux bouchons (avec indicateur de la date à laquelle a été scellée la bouteille).

- Stores wine in perfect condition and keeps all the flavour and aroma for more time.
- Extracts air built up inside the bottle and slows down the oxidation process.
- Close the bottle with the stopper and pump 10 to 20 times (depending on the amount of wine inside the bottle) to establish the vacuum.
- Includes vacuum pump and two stoppers (with indicator of the date on which the bottle has been sealed).

# BAR

## Vitrinas expositoras



ES

- Perfectos para proteger y realizar la exposición de alimentos en mostradores de bares, restaurantes, pastelerías, etc.
- Protección contra posibles contaminaciones de los alimentos.

FR

- Idéal zur Präsentation von Produkten auf den Tresen von Bars, Restaurants, Konditoreien usw.
- Schützt Speisen vor Verunreinigungen.

EN

- Perfects for protecting and highlighting products displayed on counters in bars, restaurants, bakeries, etc.
- Protection against potential food contaminants.

Protección contra posibles contaminaciones  
Protection against food contaminants



Tapa Roll-Top (Plegable)  
Roll-Top Lid (Folding)



### Tapa expositora GN 1/1

Couvercle de présentation GN 1/1 · Rolltop-Haube  
GN 1/1 display Case Lid · Expositor com tampa GN 1/1

Ref	€	cm	GN	U.Venta
66907P	36,70	53x32,5	GN 1/1	1

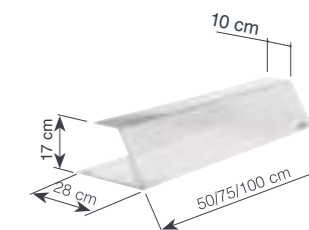

### Vitrina expositora bar

Vitrine de présentation pour bar · Tisch-Vitrine Gaststätte  
Bar display Case · Vitrina expositora para bar

Ref	€	cm	e (mm)	U.Venta
39450	56,70	50x28x17	5	1
39445	83,80	75x28x17	5	1
39441	118,90	100x28x17	5	1

ES

Un total de 5 modelos de vitrinas neutras, calientes y refrigeradas, diseñadas especialmente para presentar y exponer todo tipo de alimentos, y garantizando siempre la calidad y conservación de estos.

FR

Au total, ce sont 5 modèles de vitrines neutres, chauffantes et réfrigérées, spécialement conçues pour présenter et exposer tout type d'aliments, toujours avec la garantie de leur qualité et leur conservation.

EN

There are 5 models of neutral, warm and refrigerated display cases especially designed to present and display all kinds of food and ensure its quality and conservation at all times.



Parte trasera. Puertas traseras abatibles  
Back side. Hinged rear doors

- Vitrina neutra construida íntegramente en cristal y base de acero inoxidable.
- Diseñada para presentar y exponer sobre la barra / mostrador.
- Superficie superior curvada para una visión panorámica.
- Estante intermedio de cristal templado.
- Puerta trasera abatible.
- 4 pies de goma que garantizan máxima estabilidad.

- Vitrine neutre intégralement fabriquée en verre et base en acier inoxydable.
- Conçue pour présenter et exposer sur le plan de travail / comptoir.
- Surface supérieure courbée pour une vision panoramique.
- Étagère intermédiaire en verre trempé.
- Porte arrière rabattable.
- 4 pieds en caoutchouc qui garantissent une qualité maximale.

- Clear countertop display case made entirely of glass, including a stainless steel base.
- Designed for presenting and displaying food on the bar/countertop.
- Full view curved upper surface.
- Middle shelf made of tempered glass.
- Hinged rear door.
- 4 rubber feet for maximum stability.



### Vitrina neutra

Vitrine neutre · Einfache vitrine  
Clear countertop display case · Vitrina neutra

Ref	€	cm	h (cm)	L	U.Venta
69601	285,30	55,4x37,6	37	45	1



Rejilla extraíble, facilita el flujo del calor  
Removable racks for better heat flow



Parte trasera. Puertas traseras abatibles  
Back side. Hinged rear doors

- Vitrina térmica fabricada en acero inoxidable y cristal.
- Diseñada para conservar, presentar y exponer sobre la barra / mostrador.
- Puerta trasera abatible.
- Superficie superior inclinada para una visión panorámica.
- Recipiente de agua extraíble que aporta humedad en la cámara.
- Termostato de control de temperatura regulable: 30-90°C.
- Bandeja de rejilla extraíble que facilita el flujo del calor.

- Vitrine thermique fabriquée en acier inoxydable et verre.
- Conçue pour conserver, présenter et exposer sur le plan de travail / comptoir.
- Porte arrière rabattable.
- Surface supérieure inclinée pour une vision panoramique.
- Récipient d'eau extractible qui apporte de l'humidité à la chambre.
- Thermostat de contrôle pour régler la température : 30-90°C.
- Plateau grillagé extractible qui facilite le flux de chaleur.

- Thermal display case made of stainless steel and glass.
- Designed for storing, presenting and displaying food on the bar/countertop.
- Hinged rear door.
- Full view curved upper surface.
- Removable water tray to keep the chamber moist.
- Adjustable temperature control thermostat: 30-90°C.
- Removable racks for better heat flow.



### Vitrina térmica

Vitrine thermique · Warmhaltevitrine  
Thermal display case · Vitrina térmica

Ref	€	W	L	U.Venta
69604	577,00	800	45	1

IPX4



4 Cubetas Containers

Parte trasera. Puertas traseras correderas.  
4 / 6 cubetas gastronorm 1/3 incluidas  
Back side. Sliding rear doors. 4/6 Gastronorm 1/3 trays included



6 Cubetas Containers

### Vitrina Térmica

Vitrine thermique · Warmhaltevitrine  
Thermal display case · Vitrina térmica

	Ref	€	W	Capacidad	U.Venta
A	69602	636,20	500	4xGN1/3	1
B	69603	731,40	800	6xGN1/3	1

Ref	Tensión/Voltage	Potencia/Power	Capacidad/Capacity	Temperatura/Temp.	Protección/Protection	Dimensiones/Sizes	Peso/Weight
69602	220-240 V; 50Hz	500 W	4 x GN 1/3	30°C - 90°C	IPX4	77,3x42x33,6 cm	16 Kg
69603	220-240 V; 50 Hz	800 W	6 x GN 1/3	30°C - 90°C	IPX4	112,7x42x33,6 cm	22 Kg

Parte trasera  
Back side



### Vitrina refrigerada

Vitrine réfrigérée · Kühlvitrine  
Refrigerated display case · Vitrina refrigerada

Ref	€	W	L	U.Venta
69607	1.084,00	105	40	1

Ref	Tensión/Voltage	Potencia/Power	Capacidad/Capacity	Temperatura/Temp.	Refrigerante/Refr.	Dimensiones/Sizes	Peso/Weight
69607	220-240 V; 50Hz	105 W	40	2°C - 12°C	R600a	68x57,5x33,5 cm	25 Kg

- Vitrina térmica fabricada en acero inoxidable y cristal.
- Diseñada para conservar, presentar y exponer sobre la barra / mostrador.
- Puertas correderas para una accesibilidad total.
- Superficie superior curvada para una visión panorámica.
- 4 / 6 cubetas gastronorm 1/3 incluidas.
- Termostato de control de temperatura regulable: 30 - 90°C.

- Vitrine thermique fabriquée en acier inoxydable et verre.
- Conçue pour conserver, présenter et exposer sur le plan de travail / comptoir.
- Portes coulissantes pour une accessibilité totale.
- Surface supérieure courbée pour une vision panoramique.
- 4 / 6 bacs gastronorm 1/3 inclus.
- Thermostat de contrôle pour régler la température : 30 - 90°C.

- Thermal display case made of stainless steel and glass.
- Designed for storing, presenting and displaying food on the bar/countertop.
- Sliding doors for easy access.
- Full view curved upper surface.
- 4/6 Gastronorm 1/3 trays included.
- Adjustable temperature control thermostat: 30 - 90°C.

69602

Combinaciones posibles  
Possible combinations

GN 2/3	GN 2/3
GN 1/3	GN 1/3
GN 1/3	GN 1/3
GN 1/3	GN 1/3

69603

Combinaciones posibles  
Possible combinations

GN 2/3	GN 2/3	GN 2/3
GN 1/2	GN 1/2	GN 1/2
GN 1/2	GN 1/2	GN 1/2
GN 1/3	GN 1/3	GN 1/3
GN 1/3	GN 1/3	GN 1/3
GN 1/3	GN 1/3	GN 1/3

- Vitrina refrigerada construida íntegramente en cristal y acero inoxidable.
- Diseñada para conservar, presentar y exponer sobre la barra / mostrador.
- Puertas correderas para una accesibilidad total.
- Superficie superior inclinada para una visión panorámica.
- Sistema de enfriamiento por compresor. Función Defrost.
- Termostato de control de temperatura regulable: 2-12°C.
- Sist. de iluminación LED en la cámara interior y display de control de mandos.

- Vitrine réfrigérée intégralement fabriquée en verre et acier inoxydable.
- Conçue pour conserver, présenter et exposer sur le plan de travail / comptoir.
- Portes coulissantes pour une accessibilité totale.
- Surface supérieure courbée pour une vision panoramique.
- Système de refroidissement par compresseur.
- Thermostat de contrôle pour régler la température : 0-12°C.
- Syst. d'éclairage LED dans la chambre intérieure et écran de contrôle de commandes.

- Refrigerated display case made entirely of glass, including a st. steel base.
- Designed for storing, presenting and displaying food on the bar/countertop.
- Sliding doors for easy access.
- Full view curved upper surface.
- Compressor cooling system. Defrost function.
- Adjustable temperature control thermostat: 2-12°C.
- LED lighting for inner chamber illumination and control display unit.



**Control de temperatura regulable**  
Temperature control thermostat



**Tubo desagüe con tapón**  
Drain tube with cap

**Puertas traseras correderas**  
Sliding rear doors



**4**  
Cubetas  
Containers



**6**  
Cubetas  
Containers

- Vitrina refrigerada construida íntegramente en cristal y acero inoxidable.
- Diseñada para conservar, presentar y exponer sobre la barra / mostrador.
- Puertas correderas para una accesibilidad total.
- Superficie superior curvada para una visión panorámica.
- Sistema de enfriamiento por compresor.
- 4 / 6 cubetas gastronorm 1/3 incluidas.
- Termostato de control de temperatura regulable: 0-12°C.
- Sistema de iluminación LED en la cámara interior y display de control de mandos.

- Vitrine réfrigérée intégralement fabriquée en verre et acier inoxydable.
- Conçue pour conserver, présenter et exposer sur le plan de travail / comptoir.
- Portes coulissantes pour une accessibilité totale.
- Surface supérieure courbée pour une vision panoramique.
- Système de refroidissement par compresseur.
- 4 / 6 bacs gastronorm 1/3 inclus.
- Thermostat de contrôle pour régler la température : 0-12°C.
- Système d'éclairage LED dans la chambre intérieure et écran de contrôle de commandes.

- Refrigerated display case made entirely of glass, including a stainless steel base.
- Designed for storing, presenting and displaying food on the bar/counter top.
- Sliding doors for easy access.
- Full view curved upper surface.
- Compressor cooling system.
- 4/6 Gastronorm 1/3 trays included.
- Adjustable temperature control thermostat: 0-12°C.
- LED lighting for inner chamber illumination and control display unit.



### Vitrina refrigerada

Vitrine réfrigérée · Kühlvitrine  
Refrigerated display case · Vitrina refrigerada

Ref	€	W	Capacidad	U.Venta
<b>A</b> 69605	1236,70	160	4xGN1/3	1
<b>B</b> 69606	1371,10	160	6xGN1/3	1

Ref	Tensión/Voltage	Potencia/Power	Capacidad/Capacity	Temperatura/Temp.	Refrigerante/Refrig.	Dimensiones/Sizes	Peso/Weight
69605	220-240 V; 50Hz	160 W	4 x GN 1/3	0°C - 12°C	R600a	112,1x45x33 cm	33 Kg
69606	220-240 V; 50 Hz	160 W	6 x GN 1/3	0°C - 12°C	R600a	148,3x45x33 cm	39 Kg

# MENÚ

## Pizarras



ES

- Diseño tradicional. Ofrecen un espacio para que los establecimientos de hostelería expongan en sus locales como en la calle sus productos y menús.
- Puede ser personalizada tanto con tizas como con rotuladores.
- Limpieza muy sencilla, con un simple trapo húmedo.

FR

- Conception traditionnelle. Offre un espace pour que les établissements d'hôtellerie qui exposent, à l'intérieur ou dans la rue, leurs produits et menus.
- Personnalisable aussi bien avec des craies qu'avec des feutres.
- Nettoyage très facile, avec un simple chiffon humide.

EN

- Traditional design. It offers a space for catering establishments to exhibit their products and menus within their premises as well as out on the street.
- It can be personalized with both chalk and marker pens.
- Very simple cleaning, with just a damp cloth.



**Cadena de seguridad que evita su caída**  
Safety chain to prevent it from falling.

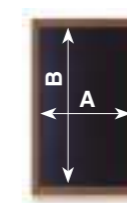

**Diseñada para ser colocada en la pared.**  
Designed to be fixed on the wall.



**A**



**B**

### Pizarra menú

Menu ardoise · Schreiftafel Menu  
Menu blackboard · Quadro de menu

Ref	€	cm	AxB (cm)	U.Venta
39166	92,30	55x85	47x67	1
39164	134,00	65x115	55x90	1

### Pizarra menú

Menu ardoise · Schreiftafel Menu  
Menu blackboard · Quadro de menu

Ref	€	cm	AxB (cm)	U.Venta
<b>A</b> 39162	50,90	50x80	43x73	1
<b>B</b> 39163	55,70	50x80	43x73	1

Madera  
Wood





NO incluidos  
NOT included

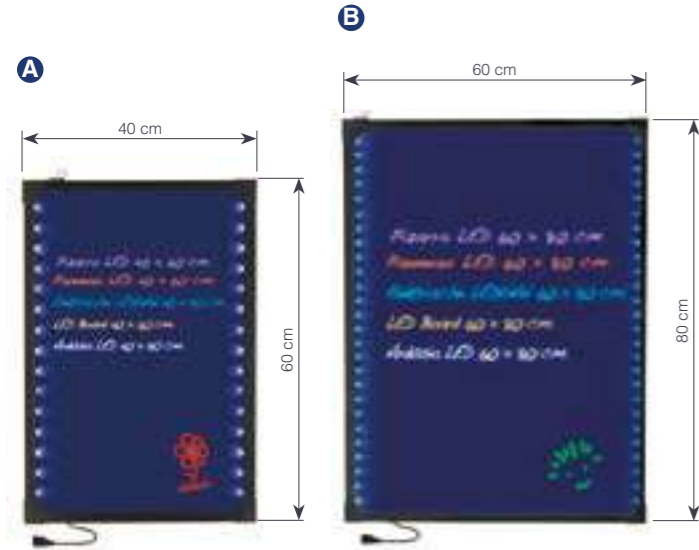

- Llamativo sistema de promoción. Gran impacto visual.
- Ideal para cualquier tipo de establecimiento: restaurantes, cafeterías, pubs, tiendas de alimentación, etc.
- Diseñadas para colocarlas tanto vertical como horizontalmente gracias a la cadena suministrada
- Uso similar de las pizarras normales, se escribe sobre la superficie (cristal templado) con rotuladores fluorescentes (Ref.:39161) y se borra con una simple bayeta de fibra.
- Realice el dibujo en la pizarra totalmente desenchufada.

- Système de promotion accrocheur. Grand impact visuel.
- Idéal pour tout type d'établissement : restaurants, cafés, pubs, magasins d'alimentation, etc.
- Conçu pour être placé aussi bien à la verticale qu'à l'horizontale, grâce à la chaîne fournie.
- Semblables à des tableaux normaux, ils permettent d'écrire sur la surface (verre trempé) avec des marqueurs fluorescents (Réf.:39161) et essuyés avec un simple chiffon en fibre.
- Dessinez sur le tableau complètement débranché.

- Eye-catching promotion system. Great visual impact.
- Ideal for any type of establishment: restaurants, cafés, pubs, food shops, etc.
- Designed to be placed both vertically and horizontally, thanks to the the supplied chain
- Similar to normal blackboards, they are used for writing on the surface (tempered glass) with fluorescent markers (Ref.:39161) and wiped off with a simple fibre cloth.
- Draw on the blackboard completely unplugged.

### Pizarra eléctrica LED

Tableau lumineux à LED · Elektronische LED Tafel  
Electric blackboard LED · Ardósia LED eléctrico

	Ref	€	U.Venta
A	39140	102,70	1
B	39160	141,00	1

Ref	Tensión/Voltage	Potencia/Power	Funcioned/Functions	Dimensiones/Sizes	Peso/Weight
39140	220-240 V; 50/60 Hz	2 W	38	40x60 cm	2,35 Kg
39160	220-240 V; 50/60 Hz	2 W	38	60x80 cm	4,50 Kg



**8 colores para usar con la pizarra eléctrica Led**  
**No tóxicos, fácil de limpiar**  
8 colors to use with the Led electric board  
Non toxic, easy to clean

### Rotuladores fluorescentes 8 colores

Marqueurs fluorescents 8 couleurs · 8-Farben fluoreszierenden marker  
8 Fluorescent markers 8 colors · Maracadores fluirescntes 8 cores

Ref	€	cm	U.Venta
39161	33,20	10	1

Portamenú  
Portamenu



# ACRÍLICO · ALUMINIO

## Portamenú

ASA AL  
Acrylic Aluminium



ES

- Diseño elegante, moderno y fabricado con materiales de máxima calidad.
- Soporte de aluminio.
- 2 o 3 posibilidades de montaje; atril, pared y sobremesa.
- Apto para mostrar menús de tamaño A4 / A3.
- Hoja de información intercambiable de forma fácil, rápida y cómoda.
- Uso en interiores y exteriores.

FR

- Style élégant, moderne et fabriqué avec des matériaux de première qualité.
- Support en aluminium.
- 2 ou 3 possibilités de montage : debout, au mur et sur la table.
- Apte pour afficher des menus de format A4 / A3.
- Changement des documents de façon rapide, facile et pratique.
- Usage à l'intérieur et à l'extérieur.

EN

- An elegant, modern design and manufactured with top quality materials.
- Aluminium stand.
- 2 or 3 mounting possibilities; standing, wall and desktop.
- Suitable for displaying A4 / A3 size menus.
- An easy, quick and convenient exchangeable information sheet.
- Indoor and outdoor use.

### ACRÍLICO

3 opciones de montaje · Mounting possibilities



**Atril:** gracias al soporte de aluminio  
*Lutrin:* grâce au support en aluminium  
*Lectern:* thanks to the aluminum support



**Pared:** gracias a los accesorios incluidos para anclar en la pared  
*Mur:* grâce aux accessoires inclus à ancrer au mur  
*Wall:* thanks to the included accessories to anchor on the wall



**Sobremesa:** gracias a los pies de apoyo incluidos  
*Bureau:* grâce aux pieds de support inclus  
*Table:* thanks to the support feet included



**Intercambiable de forma fácil, rápida y cómoda**  
Interchangeable facilement, rapidement et confortablement  
An easy, quick and convenient exchangeable

### ALUMINIO

2 opciones de montaje · Mounting possibilities



**Atril:** gracias al soporte de aluminio  
*Lutrin:* grâce au support en aluminium  
*Lectern:* thanks to the aluminum support



**Pared:** gracias a los accesorios incluidos para anclar en la pared  
*Mur:* grâce aux accessoires inclus à ancrer au mur  
*Wall:* thanks to the included accessories to anchor on the wall



**Lámina de polipropileno para evitar el degradado de la hoja de información. Marco de apertura con un solo click**  
Lame de polypropylène pour empêcher la dégrader dans feuille d'information. Cadre d'ouverture en un clic  
Polypropylene sheet to prevent the degradation in information sheet. One-click opening frame



**Intercambiable de forma fácil, rápida y cómoda**  
Interchangeable facilement, rapidement et confortablement  
An easy, quick and convenient exchangeable

### Portamenú ACRÍLICO

Porte-menu · Menü-Ständer  
Menu holder · Porta-menus

Ref	€	cm	U.Venta
A 39403	72,40	50x38 (A3)	1
B 39404	55,70	29x38 (A4)	1

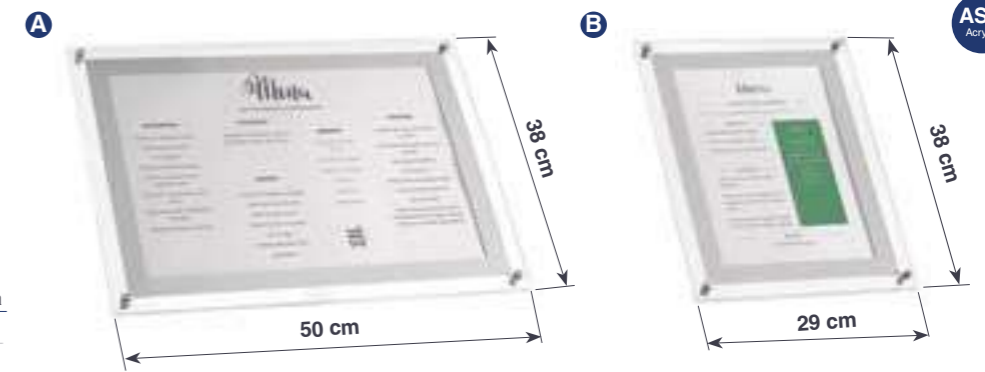

### Atril portamenú

Pupitre porte-menu · Menü-Ständer  
Menu holder lectern · Atril porta-menus

Ref	€	cm	Tamaño	U.Venta
A 39402	144,90	34x30x1,03 m	-	1
B 39423	217,30	34x30x1,07 m	A3	1
C 39424	200,50	34x30x1,07 m	A4	1



### Portamenú ALUMINIO

Porte-menu · Menü-Ständer  
Menu holder · Porta-menus

Ref	€	cm	U.Venta
A 39413	39,10	46x34 (A3)	1
B 39414	27,90	25,5x34 (A4)	1

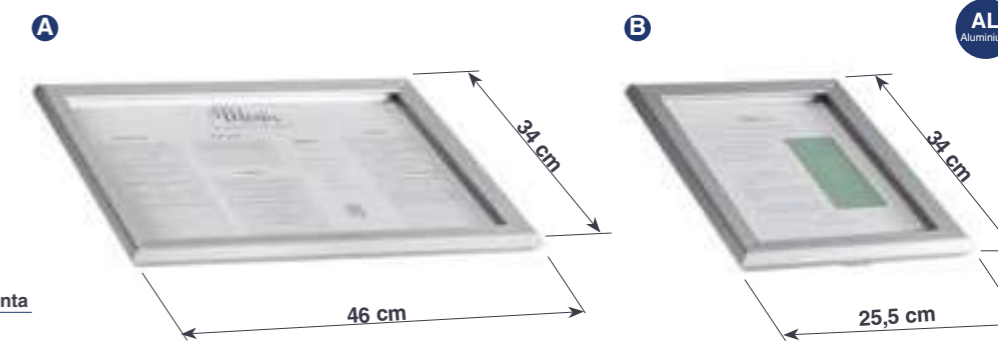

### Atril portamenú

Pupitre porte-menu · Menü-Ständer  
Menu holder lectern · Atril porta-menus

Ref	€	cm	Tamaño	U.Venta
A 39402	144,90	34x30x1,03 m	-	1
B 39433	183,90	34x30x1,07 m	A3	1
C 39434	172,70	34x30x1,07 m	A4	1



# SOBREMESA

## Portamenú



ES

- Ideales para resaltar todo tipo de información (menú, especialidades del día, promociones, etc.).
- Desmontables para escribir fácilmente.
- Fácil limpieza.

FR

- Idéales pour faire ressortir tout type d'information (Menu, spécialités du jour, promotions, etc.).
- Démontables pour écrire confortablement.
- Nettoyage facile.

EN

- Perfect for displaying all kinds of information (Fixed price menu, daily specials, promotions, etc.).
- Can be taken apart for easier writing.
- Easy to clean.

Visualización a doble cara  
Fijación mediante imán  
Base desmontable  
Double-sided display  
Magnetic fixing  
Removable base

Apta para rotuladores fluorescentes  
(Ref.: 39161)  
Soporte de madera de pino  
con acabado caoba  
Can be used with fluorescent markers  
(Ref.: 39161)  
Walnut coloured Pinewood support

Soporte de madera de pino  
con acabado caoba  
Walnut coloured Pinewood support



**Portamenú ACRYLIC**  
Porte-menu de table · Desktop-Menu  
Menu cover · Porta menu de mesa

Ref	€	cm	U.Venta
39405	10,30	11x17	1
39406	11,30	13x19	1
39407	24,40	21x30	1



**Portamenú PIZARRA**  
Porte-menu de table · Desktop-Menu  
Menu cover · Porta menu de mesa

Ref	€	cm	U.Venta
39415	15,10	10x15	1
39420	17,90	15x20	1
39430	22,10	20x30	1



**Portamenú PINZA**  
Porte-menu de table · Desktop-Menu  
Menu cover · Porta menu de mesa

Ref	€	cm	U.Venta
39410	22,70	18x23	1
A 39411	7,00	-	1

Pinza  
Clamp

# MESA

## Portamenú



**Materiales certificados** · Matériaux certifiés · Authorised materials

• Similpiel •



**Poliuretano de gran calidad con una base de tejido sin tejer suave y ligeramente extensible. Aspecto de piel y tacto único. Gracias al material termovirante, permite conseguir un atractivo efecto de estampado, consiguiendo diferentes colores según la temperatura que se le aplique.**

Polyuréthane de grande qualité avec une base de tissu intissé doux et légèrement extensible. Aspect cuir et toucher unique. Grâce au matériau thermo virant, l'on obtient un effet d'imprimé attractif, ainsi que différentes couleurs selon la température qui lui sera appliqué.

High quality polyurethane with a base of soft and slightly extendible unwoven fabric. Leather appearance and unique feel. Thanks to its heat burnishing material an attractive, printed effect is achieved, enabling different colours according to the temperature applied to it.

• Telflex •

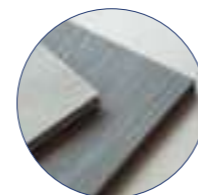

**Material compuesto por un soporte celulósico recubierto con una capa vinílica de alta resistencia. Se caracteriza por su gran flexibilidad, durabilidad y resistencia a la abrasión, manchado y rayado. Acabado imitación tela.**

Matériau composé d'un support cellulosique recouvert d'une couche vinylique hautement résistante Il se caractérise par sa grande flexibilité, durabilité et résistance à l'abrasion, aux taches et aux rayures. Finition imitation tissu.

A material comprised of a cellulose-based support covered with a high resistance vinyl layer. Characterised by its great flexibility, durability and resistance to abrasion, stains and scratches. Imitation fabric finish.

• Fibra virgen natural •



**Fabricadas en fibra virgen natural. Material ecológico y respetuoso con el medio ambiente. Lavables, resistentes y duraderas. Tacto agradable y suave, similar a la piel. Espesor 0,55 mm.**

Fabriquées en fibres vierges naturelles. Matériau écologique et respectueux de l'environnement. Lavables, résistantes et durables. Toucher agréable et doux, similaire au cuir. Épaisseur de 0,55 mm.

Made of natural virgin fibre. Ecological material respectful with the environment. Washable, resistant and durable. Nice soft feel, similar to leather. Thickness 0.55 mm.

• PVC •



**Fabricados en PVC rígido transparente de alta calidad. Versátiles, económicos, resistentes y ligeros. Hojas transparentes por ambos lados. Ribeteado con cuero cosido en recto. Esquineros metálicos de color negro. Se limpian fácilmente con solución hidroalcohólica sin dañar el producto.**

Fabriqués en PVC rigide transparent de grande qualité. Versatiles, économiques, résistants et légers. Feuilles transparentes des deux côtés. Finition avec du cuir cousu sur le recto. Angles métalliques de couleur noire. Nettoyage facile avec du savon, de l'alcool, du gel hydroalcoolique, etc. sans abîmer le produit.

Made of high quality transparent rigid PVC. Versatile, economical, strong and light weight. Transparent sheets on both sides. Edged with straight sewn leather. Black metal corner pieces. Easy to clean with soap, alcohol, hydrogel, etc. without damaging the product.

• Antibacteriano •  
Antibacterial

### NOTA · NOTE:

**La limpieza deberá realizarse con un paño húmedo, pero no saturado de agua. Evite el contacto y la inmersión en agua. Evite manipularlo con las manos mojadas. NO aptos para el lavavajillas**

The cleaning should be done with a damp cloth, but not saturated with water. Avoid contact and immersion in water. Avoid handling with wet hands. NOT suitable for dishwashers



Lacor pone a disposición del cliente la opción de personalizar cualquiera de las colecciones. La personalización se realiza mediante la técnica de estampado en caliente ( termosellado). El logotipo deberá ser enviado vectorizado en formato Adobe Illustrator sino el vectorizado del sello se cobrará 20 €.

Se debe indicar tanto el posicionamiento como el color entre las siguientes opciones:

Lacor propose au client la possibilité de personnaliser n'importe laquelle des collections. La personnalisation est réalisée selon la technique d'estampage à chaud (Thermoscellage). Pour ce faire, le logo devra être envoyé vectorisé en format Adobe Illustrator mais la vectorisation du timbre sera facturée 20 €. Il est nécessaire d'indiquer aussi bien le positionnement que la couleur parmi les options suivantes ::

Lacor offers clients the option of customising any of its collections. Customisation is performed via hot stamping. The logo must be sent in vector format using Adobe Illustrator but the vectorization of the stamp will be charged 20€. Both the position and the colour of the logo must be indicated, choosing from the following options:

**Precio · Tarif · Preisliste · Cost · Custo:**

España & Portugal: 42€ / Francia: 46€ ( a partir de 15 unidades)

Espagne & Portugal: 42€ / France: 46€ (à partir de 15 unités)

Spain & Portugal: 42€ / France: 46€ ( minimum 15 units)

**\* Nota · Note:**

El plazo de entrega para los portamenús personalizados es de 15 días naturales

The delivery period for the personal portamenús is 15 calendar days



**Posicionamiento orientativo**

Guidance position

**A: Óptico** · Optical

**B: Centro** · Centre

**C: Pie centro** · Bottom centre

**D: Pie drecho** · Bottom right

**Color**

Coleur · Farbe · Colour · Cor

**En seco (sin color)** · Dry (without colour)

**Blanco** · White

**Negro** · Black

**Rojo** · Red

**Oro** · Gold

**Plata** · Silver

**Crema** · Cream

**Marrón** · Brown

**Azul** · Blue

**NOTA · NOTE:**

**NO se recomienda la estampación en seco en las colecciones**  
Dry printing is NOT recommended in the collections

LISA · VELÁZQUEZ · HELEN · TOMASSO · ANDRÉ · MATISSE · CHARLOTTE · DEGAS · CASSAT · EDGAR · SOPHIE · PAUL  
GOYA · MARCEL · ANDY · NATURAL · TEX

· **Made in Spain** ·

Fabricados en España · Fabriqués en Espagne

Spanischer produktion · Fabricados en Espanha

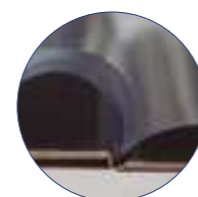

**FUNDAS fijas PVC** · Protège-feuilles PVC · PVC covers

**Fundas fijas de PVC en piel de naranja. Altamente resistentes**  
Protège-feuilles fixes en PVC en peau d'orange. Hautement résistantes  
Highly resistant, fixed frosted PVC covers



**SOLAPAS fijas** · Rabats fixes · Fixed flaps

**Solapas fijas a la cubierta**  
Rabats fixes sur la couverture  
Flaps fixed to the cover

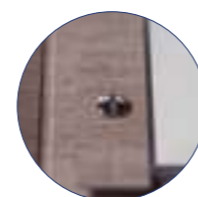

**ATORNILLADO interior** · Vissage intérieur · Screwed interior

**Atornillado interior permite añadir o cambiar hojas o fundas según necesidad del cliente**  
Vissage intérieur pour intégrer des feuilles ou des protège-feuilles selon les besoins de l'utilisateur  
Screwed interior to include pages or covers, according to the user's needs



**ATORNILLADO exterior** · Vissage extérieur · Screwed exterior

**Atornillado exterior permite añadir hojas o fundas según necesidad del cliente**  
Vissage extérieur pour intégrer des feuilles ou des protège-feuilles selon les besoins de l'utilisateur  
Screwed exterior to include pages or covers, according to the user's needs



**CORDÓN DE CUERO** · Cordon en cuir · Leather cord

**Encuadernado con cordón de cuero. Permite añadir hojas o fundas según necesidad del cliente**  
Relié avec un cordon en cuir. Permet d'ajouter des feuilles ou des pochettes selon les besoins du client  
Bound with leather cord. New pages or covers can be added as the customer needs



**GOMA** · Élastique · Elastic band

**Encuadernado con goma. Permite añadir hojas o fundas según necesidad del cliente**  
Relié avec élastique. Permet d'ajouter des feuilles ou des pochettes selon les besoins du client  
Bound with elastic band. New pages or covers can be added as the customer needs



**PINZA** · Pince · Clip

**Con pinza metálica de color plata que sujeta la hoja del menú**  
Doté d'une pince métallique couleur argent qui tient la feuille du menu  
With a silver-coloured metal clip that holds the menu in place

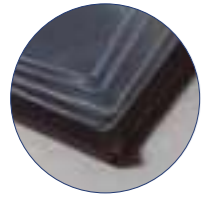

**Set 10 fundas interiores PVC piel de naranja**

Jeu 10 feuilles intérieures PVC Peau d'orange · 10 Tlg. Innere Blätter, PVC, Orangerhaut  
Set 10 interior frosted PVC pages · Set 10 lâminas interiores de PVC pele de Laranja

Ref	€	cm	U.Venta	
28191	11,70	21x29,7 (A4)	10	Ref.: 28261, 28500, 28510, 28520, 28530
28192	9,10	14x26	10	Ref.: 28511, 28531, 28521, 28501, 28212, 28262
28190	8,10	16x29,7	10	Ref.: 28342, 28352, 28372
28193	9,20	14,8x21 (A5)	10	Ref.: 28512, 28343, 28532, 28353, 28522, 28373, 28502, 28213, 28263
28194	11,70	21x29,7 (A4)	10	Ref.: 28550, 28540, 28371, 28351
28203	11,70	25x32 (A4)	10	Ref.: 28211, 28231, 28341, 28391
28451	11,90	23x31 (Doble/Double)	10	Ref.: 28411, 28431
28452	10,30	17x32 (Doble/Double)	10	Ref.: 28412, 28432
28453	7,30	16,5x23,5 (Doble/Double)	10	Ref.: 28413, 28423, 28443

**Set 12 cantoneras**

Jeu 12 coins · 12 Tlg. Kantenschutz  
Set 12 angle irons · Set 12 cantoneiras

Ref	€	Color	U.Venta
28195	5,10	Negro · Black	1
28197	5,10	Oro · Gold	1
28198	5,10	Plata · Silver	1

**Set 12 tornillos**

Jeu 12 vis · 12 Tlg. Schrauben  
Set 12 screws · Set 12 parafusos

Ref	€	Color	U.Venta
28196	10,60	Plata · Silver	1
28199	10,90	Negro · Black	1

**Set 12 cordones de cuero**

Jeu 12 cordons en cuir · 12 Tlg. Lederschnur  
Set 12 leather laces · Set 12 cordões de couro

Ref	€	Color	m	U.Venta
28200	1,50	Marrón · Brown	1	12

**Set 10 gomas**

Jeu 10 élastiques · 10 Tlg. Gummis  
Set 10 elastic bands · Set 10 elásticos

Ref	€	Color	U.Venta	
28205	7,20	Negro · Black	1	Ref.: 28411, 28412, 28422, 28432
28206	7,20	Negro · Black	1	Ref.: 28413, 28433



Opción de personalizar  
Option of customising

Se recomienda hacerlo en los colores blanco, azul, negro, rojo y marrón  
Il est recommandé de le faire dans les couleurs blanc, bleu, noir, rouge et marron  
It is recommended to do it in the colors white, blue, black, red and brown

**Antibacteriano · Antibacterial**

- Ideal para cartas de restaurantes, bares, hoteles, etc.
- Fabricados en PVC rígido transparente de alta calidad.
- Versátiles y económicos. Resistentes y ligeros.
- Hojas transparentes por ambos lados.
- Ribeteado con cuero cosido en recto.
- Esquineros metálicos de color negro.
- Se limpian fácilmente con solución hidroalcohólica sin dañar el producto.

- Idéal pour les cartes des restaurants, bars, hôtels, etc.
- Fabriqués en PVC rigide transparent de grande qualité.
- Versatiles et économiques. Résistants et légers.
- Feuilles transparentes des deux côtés.
- Finition avec du cuir cousu sur le recto.
- Angles métalliques de couleur noire.
- Nettoyage facile avec du savon, de l'alcool, du gel hydroalcoolique, etc. sans abîmer le produit.

- Perfect for restaurant, bar or hotel menus.
- Made of high quality transparent rigid PVC.
- Versatile and economical. Strong and light weight.
- Transparent sheets on both sides.
- Edged with straight sewn leather.
- Black metal corner pieces.
- Easy to clean with soap, alcohol, hydrogel, etc. without damaging the product.



Esquineros metálicos  
Metal corners

**Portamenú A5**

Porte-menu A5 · Speisekartenmappe, A5  
A5 menu cover · Porta menu A5

	Ref	€	cm	Fundas	U.Venta
A	28400	8,10	A5	Individual · Individual	1
B	28401	12,40	A5	Doble · Double	1



Esquineros metálicos  
Metal corners

**Portamenú A4**

Porte-menu A4 · Speisekartenmappe, A4  
A4 menu cover · Porta menu A4

	Ref	€	cm	Fundas	U.Venta
A	28402	9,90	A4	Individual · Individual	1
B	28403	16,50	A4	Doble · Double	1
C	28404	19,20	A4	Triple · Triplex	1
D	28405	20,80	A4	Cuádruple · Quadruple	1

# NATURAL



Blando · Soft

Fabricado en fibra virgen natural  
Termosellado en color negro  
Sujeción con goma  
Made of natural virgin fibre  
Heat stamping in black  
Closes with elastic band

## Portamenú

Porte-menu · Speisekartenmappe  
Menu cover · Porta menu

	Ref	€	cm	Fundas	U.Venta
A	28411	20,80	23x32 (A4)	4	4
B	28412	19,20	17x32	6	4
C	28413	17,00	16,5x23,5 (A5)	6	4



# TEX



Blando · Soft

Fabricado en fibra virgen natural  
Termosellado en color negro  
Sujeción con goma  
Made of natural virgin fibre  
Heat stamping in black  
Closes with elastic band

## Portamenú

Porte-menu · Speisekartenmappe  
Menu cover · Porta menu

	Ref	€	cm	Fundas	U.Venta
A	28431	20,80	23x32 (A4)	4	4
B	28432	19,20	17x32	6	4
C	28433	17,00	16,5x23,5 (A5)	6	4



# HELEN



Fabricado en simlpiel  
Termosellado en color marrón  
Encuadernado con cordón de cuero  
Manufactured in imitation leather  
Heat stamping in brown  
Bound with leather cord

## Portamenú

Porte-menu · Speisekartenmappe  
Menu cover · Porta menu

	Ref	€	cm	Fundas	U.Venta
A	28341	25,50	25,5x32 (A4)	3	4
B	28342	20,90	19,5 x 32	3	4
C	28343	19,70	19x23,5 (A5)	3	4

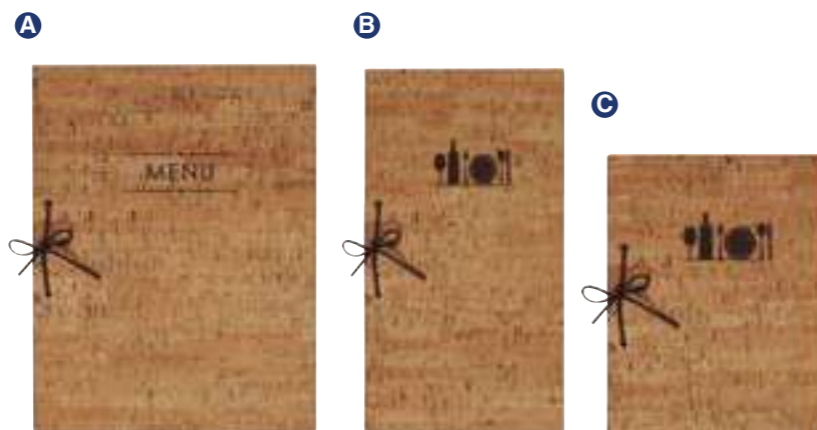

# VELÁZQUEZ



Fabricado en simlpiel  
Termosellado en color marrón  
Sujeción fija  
Manufactured in imitation leather  
Heat stamping in brown  
Fixed clamping

## Portamenú

Porte-menu · Speisekartenmappe  
Menu cover · Porta menu

	Ref	€	cm	Fundas	U.Venta
A	28331	24,40	23x32 (A4)	4	4
B	28332	19,50	16x28,5	4	4
C	28333	18,60	17x23,5 (A5)	4	4

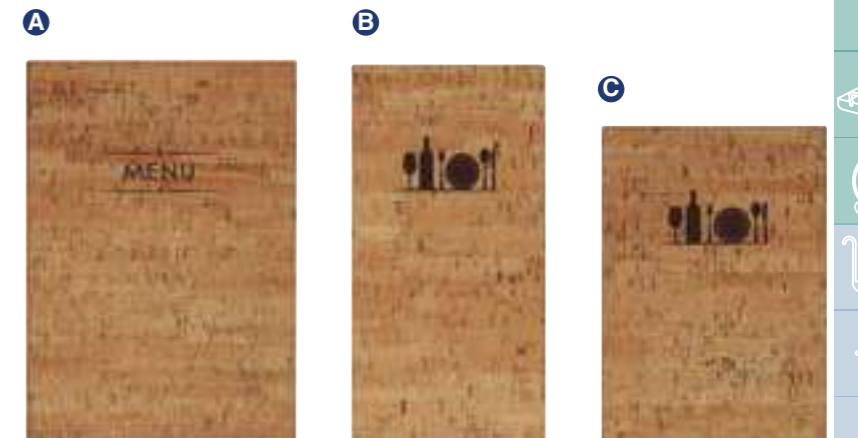

## Portacomandas

Porte-commandes · Halter für Bestellungen  
Order holder · Porta comandas

Ref	€	cm	U.Venta
28175	12,00	11x17,5	4



## Portafacturas

Porte-factures · Halter für Rechnungen  
Ticket holder · Porta facturas

Ref	€	cm	U.Venta
28176	19,20	11x18,5	4

# LISA



Fabricado en simlpiel  
Termosellado en color marrón  
Solapas fijas a la cubierta  
Manufactured in imitation leather  
Heat stamping in brown  
Flaps fixed to the cover

## Portamenú

Porte-menu · Speisekartenmappe  
Menu cover · Porta menu

Ref	€	cm	U.Venta
28177	22,30	23 x 32 (A4)	4



# SANDRO



Fabricado en telflex  
 Termosellado en color azul  
 Atornillado exterior permite añadir  
 hojas o fundas según necesidad del  
 cliente  
 Manufactured in telflex  
 Heat stamping in blue  
 Screwed exterior to include pages or  
 covers, according to the user's needs

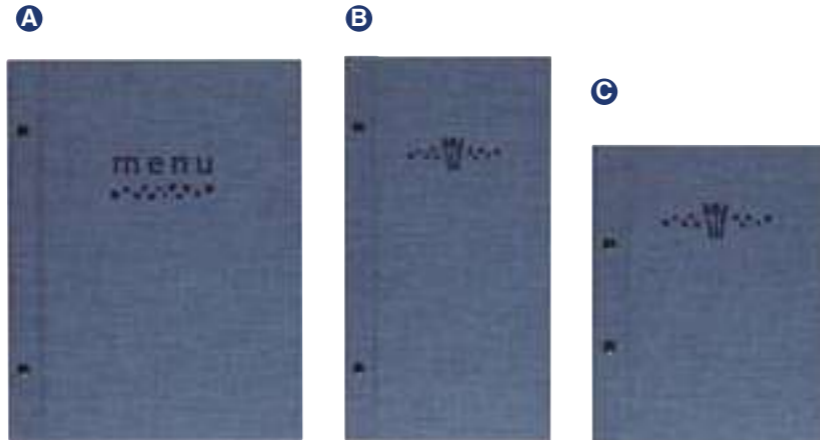

## Portamenú

Porte-menu · Speisekartenmappe  
 Menu cover · Porta menu

Ref	€	cm	Fundas	U.Venta
<b>A</b> 28371	24,70	25,5x32 (A4)	3	4
<b>B</b> 28372	20,30	19,5x32	3	4
<b>C</b> 28373	18,90	19x23,5 (A5)	3	4



## Portacomandas

Porte-commandes · Halter für Bestellungen  
 Order holder · Porta comandas

Ref	€	cm	U.Venta
28375	11,60	11x17,5	4



## Porta facturas

Porte-factures · Halter für Rechnungen  
 Ticket holder · Porta facturas

Ref	€	cm	U.Venta
28376	18,50	11x18,5	4

# RENÉ



Fabricado en simlpiel  
 Termosellado en color crema  
 Sujeción fija  
 Manufactured in imitation leather  
 Heat stamping in cream  
 Fixed clamping

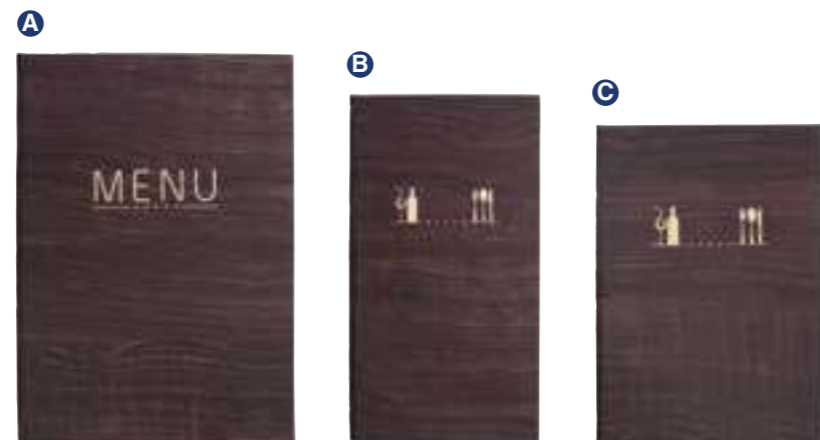

## Portamenú

Porte-menu · Speisekartenmappe  
 Menu cover · Porta menu

Ref	€	cm	Fundas	U.Venta
<b>A</b> 28021	24,40	23x32 (A4)	4	4
<b>B</b> 28022	18,60	16x28,5	4	4
<b>C</b> 28023	19,50	17x23,5 (A5)	4	4

# NICOLÁS



Fabricado en simlpiel  
 Termosellado en color crema  
 Atornillado interior permite añadir o  
 cambiar hojas o fundas según necesi-  
 dad del cliente  
 Manufactured in imitation leather  
 Heat stamping in cream  
 Screwed interior to include pages or  
 covers, according to the user's needs

Blando · Soft

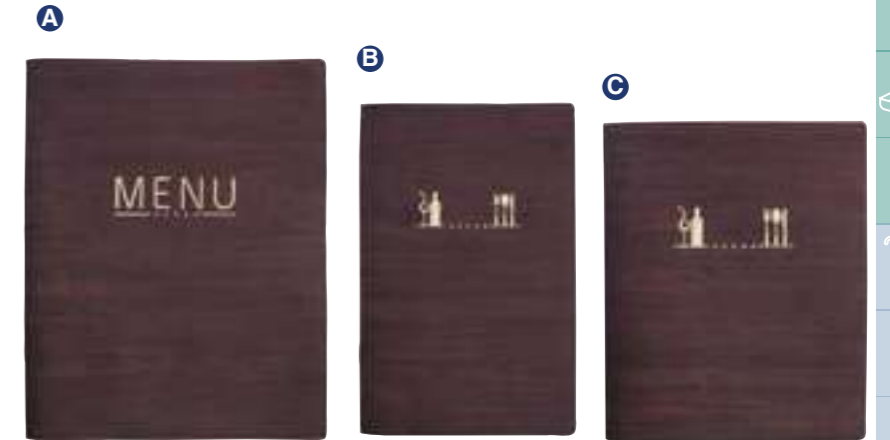

## Portamenú

Porte-menu · Speisekartenmappe  
 Menu cover · Porta menu

Ref	€	cm	Fundas	U.Venta
<b>A</b> 28510	37,70	25,5x32 (A4)	3	4
<b>B</b> 28511	32,10	18x28,5	3	4
<b>C</b> 28512	32,70	19x23,5 (A5)	3	4

# ANDRÉ



Fabricado en telflex  
 Termosellado en color crema  
 Sujeción fija  
 Manufactured in telflex  
 Heat stamping in cream  
 Fixed clamping

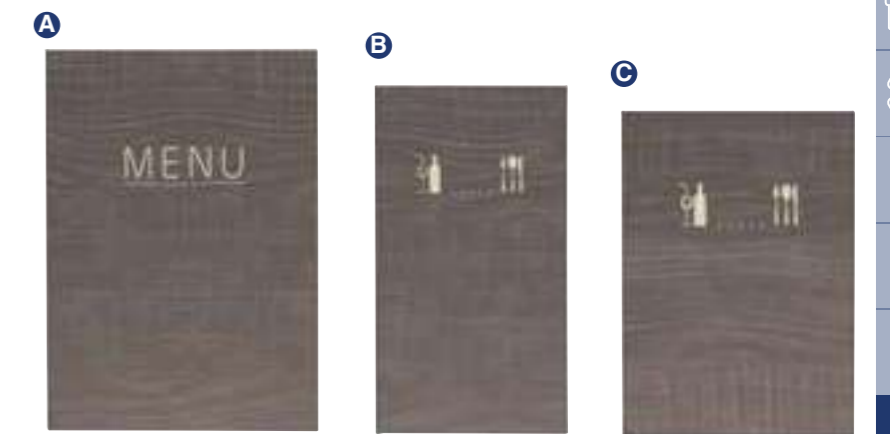

## Portamenú

Porte-menu · Speisekartenmappe  
 Menu cover · Porta menu

Ref	€	cm	Fundas	U.Venta
<b>A</b> 28031	21,20	23x32 (A4)	4	4
<b>B</b> 28032	15,90	16x28,5	4	4
<b>C</b> 28033	16,60	17x23,5 (A5)	4	4

# CÉZANE



Fabricado en simlpiel  
 Termosellado en color crema  
 Solapas fijas a la cubierta  
 Manufactured in imitation leather  
 Heat stamping in cream  
 Flaps fixed to the cover



## Portamenú

Porte-menu · Speisekartenmappe  
 Menu cover · Porta menu

Ref	€	cm	U.Venta
28041	20,30	23x32 (A4)	4

# LEO



**Fabricado en simlpiel**  
**Termosellado en color crema**  
**3 solapas transparentes en renoglass 0,40 mm**  
 Manufactured in imitation leather  
 Heat stamping in cream  
 3 transparent flaps in renoglass 0,40 mm



## Portamenú

Porte-menu · Speisekartenmappe  
 Menu cover · Porta menu

Ref	€	cm	Solapas	U.Venta
28151	29,50	23x32 (A4)	3	4

# TIZIANO



**Fabricado en simlpiel**  
**Termosellado en color crema**  
**3 solapas transparentes en renoglass 0,40 mm**  
 Manufactured in imitation leather  
 Heat stamping in cream  
 3 transparent flaps in renoglass 0,40 mm



## Portamenú

Porte-menu · Speisekartenmappe  
 Menu cover · Porta menu

Ref	€	cm	Solapas	U.Venta
28172	27,00	17x24 (A5)	3	4

# CLAUDIO



**Fabricado en simlpiel**  
**Con pinza metálica de color plata que sujeta la hoja del menú**  
 Manufactured in imitation leather  
 With a silver-coloured metal clip that holds the menu in place



## Portamenú

Porte-menu · Speisekartenmappe  
 Menu cover · Porta menu

Ref	€	cm	U.Venta
28321	17,00	23,5x33,5(A4)	4

# MATISSE



**Fabricado en simlpiel**  
**Termosellado en color negro**  
**Sujeción fija**  
 Manufactured in imitation leather  
 Heat stamping in black  
 Fixed clamping

## Portamenú

Porte-menu · Speisekartenmappe  
 Menu cover · Porta menu

Ref	€	cm	Fundas	U.Venta
A 28051	24,40	23x32 (A4)	4	4
B 28052	18,60	16x28,5	4	4
C 28053	19,50	17x23,5 (A5)	4	4

# CHARLOTTE



**Fabricado en simlpiel**  
**Termosellado en color negro**  
**Atornillado interior permite añadir o cambiar hojas o fundas según necesidad del cliente**  
 Manufactured in imitation leather  
 Heat stamping in black  
 Screwed interior to include pages or covers, according to the user's needs

## Portamenú

Porte-menu · Speisekartenmappe  
 Menu cover · Porta menu

Ref	€	cm	Fundas	U.Venta
A 28530	37,70	25,5x32 (A4)	3	4
B 28531	32,70	18x28,5	3	4
C 28532	32,10	19x23,5 (A5)	3	4

# TOMASSO



**Fabricado en simlpiel**  
**Termosellado en color negro**  
**Atornillado exterior permite añadir hojas o fundas según necesidad del cliente**  
 Manufactured in imitation leather  
 Heat stamping in black  
 Screwed exterior to include pages or covers, according to the user's needs

## Portamenú

Porte-menu · Speisekartenmappe  
 Menu cover · Porta menu

Ref	€	cm	Fundas	U.Venta
A 28351	25,80	25,5x32 (A4)	3	4
B 28352	21,20	19,5x32	3	4
C 28353	20,00	19x23,5 (A5)	3	4

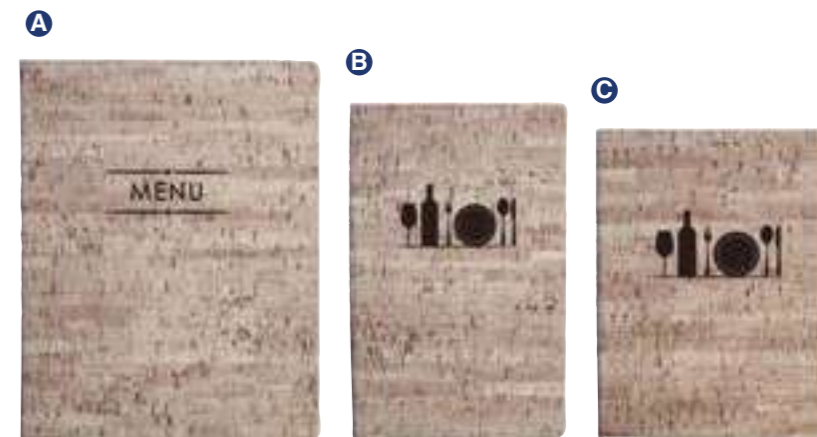
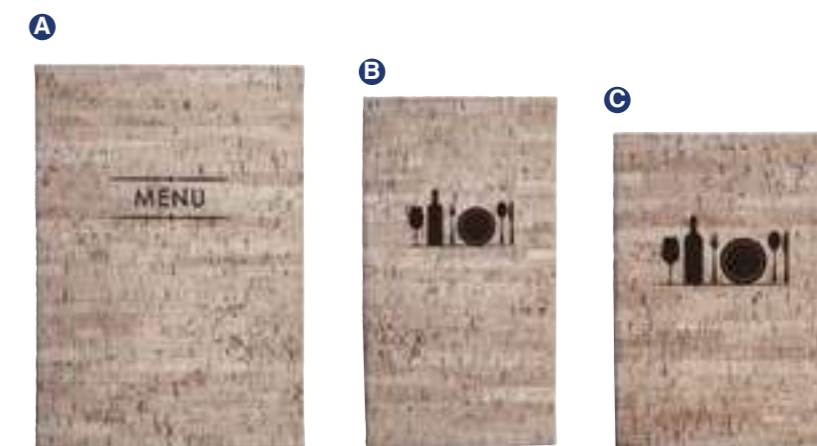



# DEGAS



**Fabricado en simlpiel**  
**Termosellado en color negro**  
**Solapas fijas a la cubierta**  
 Manufactured in imitation leather  
 Heat stamping in black  
 Flaps fixed to the cover



## Portamenú

Porte-menu · Speisekartenmappe  
 Menu cover · Porta menu

Ref	€	cm	U.Venta
28141	22,30	23x32 (A4)	4

# CASSAT



**Fabricado en telflex**  
**Termosellado en color negro**  
**Sujeción fija**  
 Manufactured in telflex  
 Heat stamping in black  
 Fixed clamping

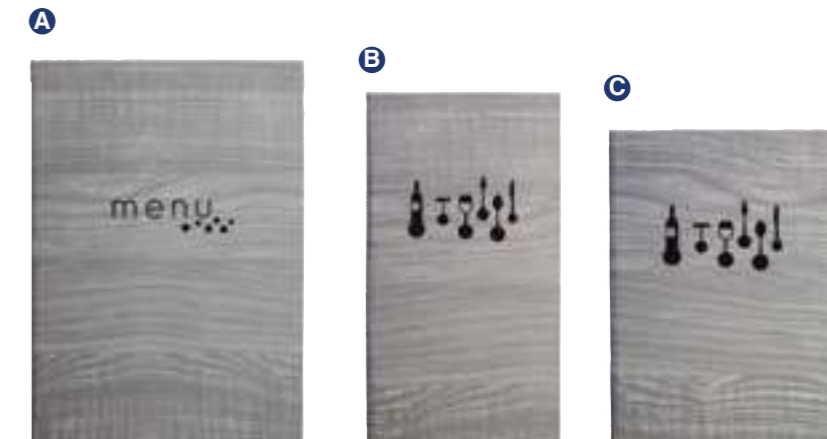

## Portamenú

Porte-menu · Speisekartenmappe  
 Menu cover · Porta menu

	Ref	€	cm	Fundas	U.Venta
A	28061	21,20	23x32 (A4)	4	4
B	28062	15,90	16x28,5	4	4
C	28063	16,60	17x23,5 (A5)	4	4

# GOYA



**Fabricado en simlpiel**  
**Termosellado en color negro**  
**3 solapas transparentes en renoglass 0,40 mm**  
 Manufactured in imitation leather  
 Heat stamping in black  
 3 transparent flaps in renoglass  
 0,40 mm



## Portamenú

Porte-menu · Speisekartenmappe  
 Menu cover · Porta menu

Ref	€	cm	Solapas	U.Venta
28161	29,50	23x32 (A4)	3	4

# EDGAR



**Fabricado en telflex**  
**Termosellado en color negro**  
**Atornillado exterior permite añadir hojas o fundas según necesidad del cliente**  
 Manufactured in telflex  
 Heat stamping in black  
 Screwed exterior to include pages or covers, according to the user's needs



## Portamenú

Porte-menu · Speisekartenmappe  
 Menu cover · Porta menu

Ref	€	cm	Fundas	U.Venta
28540	22,40	25,5x32 (A4)	3	4

# MARCEL



**Fabricado en simlpiel**  
**Termosellado en color negro**  
**3 solapas transparentes en renoglass 0,40 mm**  
 Manufactured in imitation leather  
 Heat stamping in black  
 3 transparent flaps in renoglass  
 0,40 mm



## Portamenú

Porte-menu · Speisekartenmappe  
 Menu cover · Porta menu

Ref	€	cm	Solapas	U.Venta
28182	27,00	17x24 (A5)	3	4

# MAX



**Fabricado en telflex**  
**Con pinza metálica de color plata que sujeta la hoja del menú**  
 Manufactured in telflex  
 With a silver-coloured metal clip that holds the menu in place

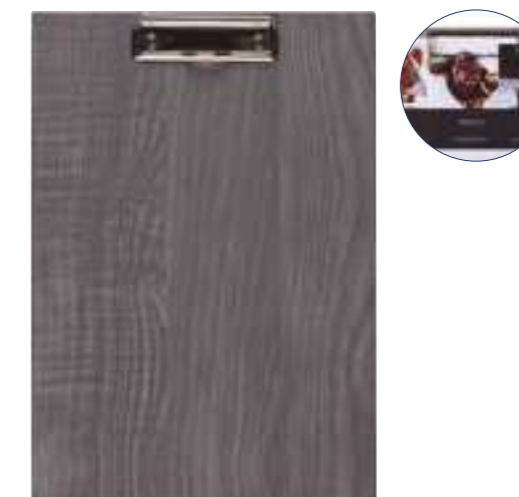

## Portamenú

Porte-menu · Speisekartenmappe  
 Menu cover · Porta menu

Ref	€	cm	U.Venta
28311	13,70	23,5x33,5(A4)	4

# DALÍ



**Fabricado en simlpiel**  
**Termosellado en color blanco**  
**Sujeción fija**  
 Manufactured in imitation leather  
 Heat stamping in white  
 Fixed clamping

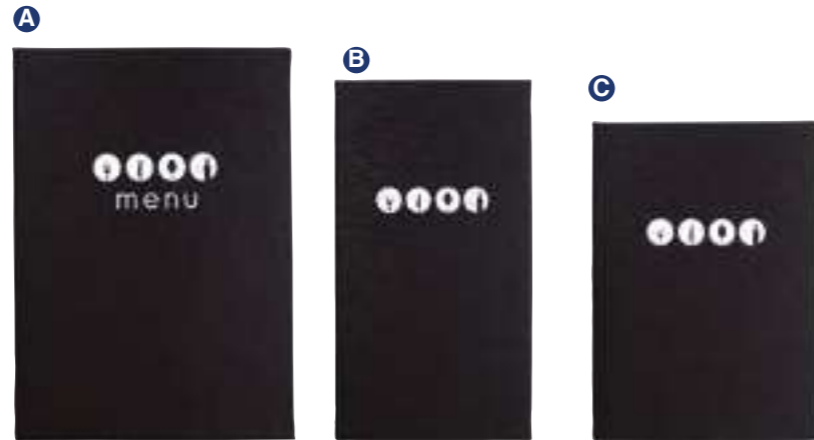

## Portamenú

Porte-menu · Speisekartenmappe  
 Menu cover · Porta menu

Ref	€	cm	Fundas	U.Venta
<b>A</b> 28101	22,70	23x32 (A4)	4	4
<b>B</b> 28102	17,40	16x28,5	4	4
<b>C</b> 28103	18,30	17x23,5 (A5)	4	4

# MARIE



**Fabricado en simlpiel**  
**Termosellado en color blanco**  
**Solapas fijas a la cubierta**  
 Manufactured in imitation leather  
 Heat stamping in white  
 Flaps fixed to the cover



## Portamenú

Porte-menu · Speisekartenmappe  
 Menu cover · Porta menu

Ref	€	cm	U.Venta
28560	20,00	23x32 (A4)	4

# FRIDA



**Fabricado en simlpiel**  
**Termosellado en color negro**  
**Sujeción fija**  
 Manufactured in imitation leather  
 Heat stamping in black  
 Fixed clamping

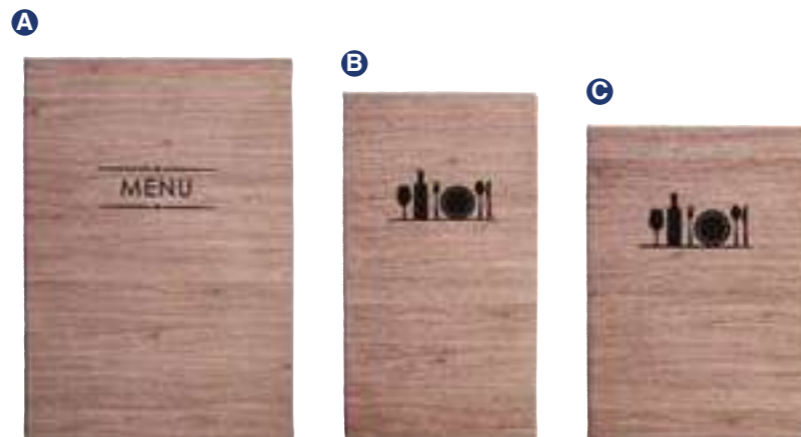

## Portamenú

Porte-menu · Speisekartenmappe  
 Menu cover · Porta menu

Ref	€	cm	Fundas	U.Venta
<b>A</b> 28011	24,40	23x32 (A4)	4	4
<b>B</b> 28012	18,60	16x28,5	4	4
<b>C</b> 28013	19,50	17x23,5 (A5)	4	4

# VERMEER



**Blando · Soft**

**Fabricado en simlpiel**  
**Termosellado en color negro**  
**Atornillado interior permite añadir o**  
**cambiar hojas**  
**o fundas según necesidad del cliente**  
 Manufactured in imitation leather  
 Heat stamping in black  
 Screwed interior to include pages or  
 covers, according to the user's needs

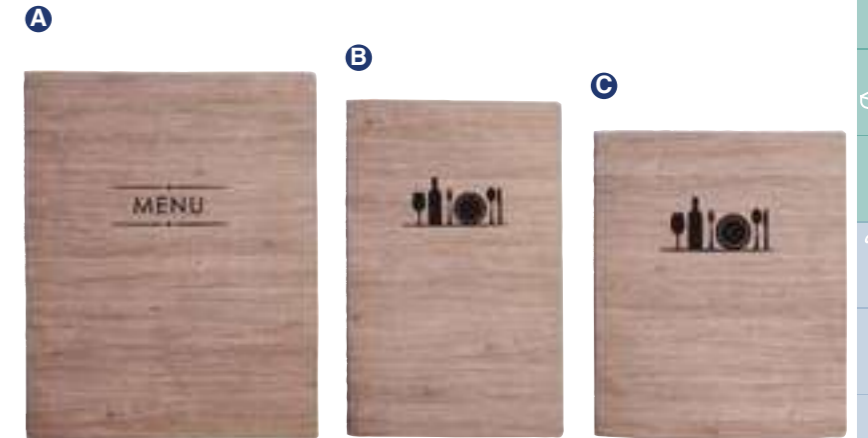

## Portamenú

Porte-menu · Speisekartenmappe  
 Menu cover · Porta menu

Ref	€	cm	Fundas	U.Venta
<b>A</b> 28500	37,70	25,5x32 (A4)	3	4
<b>B</b> 28501	32,10	18x28,5	3	4
<b>C</b> 28502	32,70	19x23,5 (A5)	3	4

# SOPHIE



**Fabricado en telflex**  
**Termosellado en color negro**  
**Sujeción fija**  
 Hergestellt aus telflex  
 Heat stamping in black  
 Fixed clamping

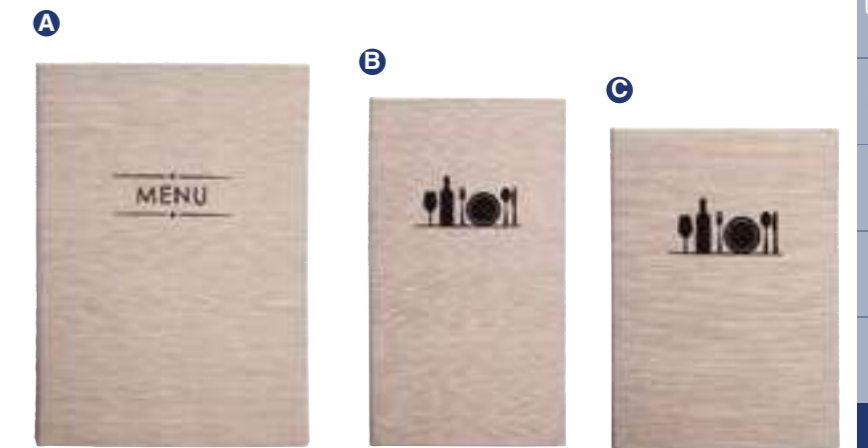

## Portamenú

Porte-menu · Speisekartenmappe  
 Menu cover · Porta menu

Ref	€	cm	Fundas	U.Venta
<b>A</b> 28081	21,80	23x32 (A4)	4	4
<b>B</b> 28082	16,50	16x28,5	4	4
<b>C</b> 28083	17,00	17x23,5 (A5)	4	4

# PAUL



**Fabricado en telflex**  
**Termosellado en color negro**  
**Atornillado exterior permite añadir**  
**hojas o fundas según necesidad del**  
**cliente**  
 Hergestellt aus telflex  
 Heat stamping in black  
 Screwed exterior to include pages or  
 covers, according to the user's needs



## Portamenú

Porte-menu · Speisekartenmappe  
 Menu cover · Porta menu

Ref	€	cm	Fundas	U.Venta
28550	24,20	25,5x32 (A4)	3	4

# PABLO

**Fabricado en simlpiel**  
**Termosellado en color blanco**  
**Atornillado interior permite añadir o**  
**cambiar hojas o fundas según**  
**necesidad del cliente**  
 Manufactured in imitation leather  
 Heat stamping in white  
 Screwed interior to include pages or  
 covers, according to the user's needs

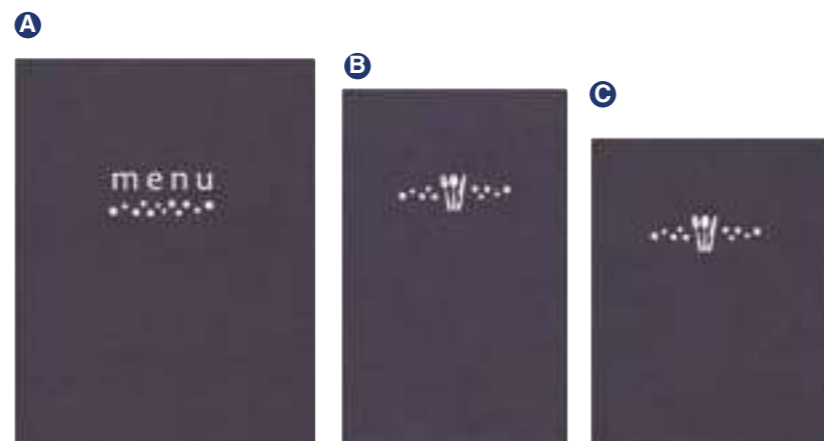

## Portamenú

Porte-menu · Speisekartenmappe  
 Menu cover · Porta menu

	Ref	€	cm	Fundas	U.Venta
A	28211	30,00	25x32 (A4)	3	4
B	28212	25,10	18x28	3	4
C	28213	24,20	19,5x23,5 (A5)	3	4

# ISABELLE

**Fabricado en simlpiel**  
**Termosellado en color plata**  
**Sujeción fija**  
 Manufactured in imitation leather  
 Heat stamping in silver  
 Fixed clamping

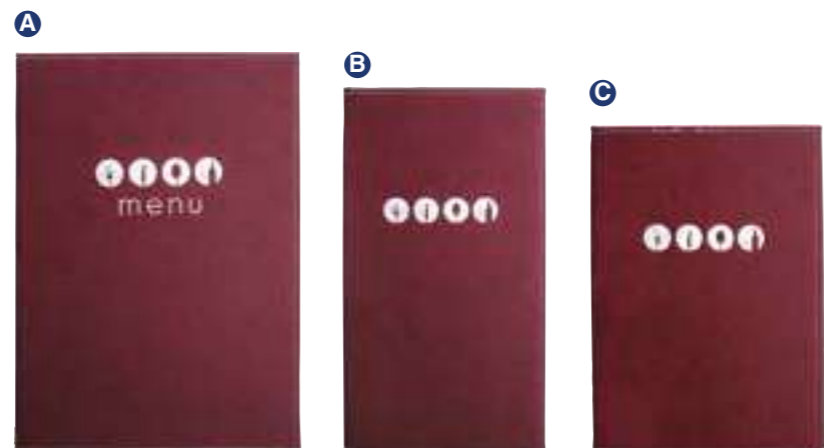

## Portamenú

Porte-menu · Speisekartenmappe  
 Menu cover · Porta menu

	Ref	€	cm	Fundas	U.Venta
A	28001	26,40	23x32 (A4)	4	4
B	28002	19,70	16x28,5	4	4
C	28003	20,70	17x23,5 (A5)	4	4

# MILLET

**Fabricado en simlpiel**  
**Termosellado en color negro**  
**Sujeción fija**  
 Manufactured in imitation leather  
 Heat stamping in black  
 Fixed clamping

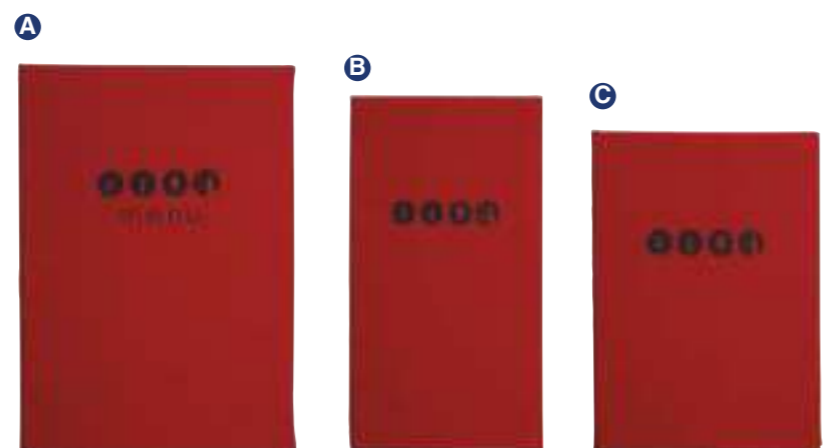

## Portamenú

Porte-menu · Speisekartenmappe  
 Menu cover · Porta menu

	Ref	€	cm	Fundas	U.Venta
A	28131	22,70	23x32 (A4)	4	4
B	28132	17,40	16x28,5	4	4
C	28133	18,30	17x23,5 (A5)	4	4

# GEORGIA



**Fabricado en telflex**  
**Con pinza metálica de color plata**  
**que sujeta la hoja del menú**  
 Manufactured in telflex  
 With a silver-coloured metal clip  
 that holds the menu in place

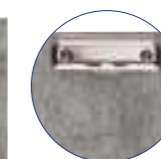

## Portamenú

Porte-menu · Speisekartenmappe  
 Menu cover · Porta menu

	Ref	€	cm	U.Venta
	28396	14,30	23,5x33,5(A4)	4



# 04

**Corte**  
Cutting



# PROFESIONAL

## Colección



### Cortador de bolas

Cuillère à pommes · Kugelausstecher  
Fruit baller · Cortador bolas

Ref	€	Ø (mm)	U.Venta
60366	7,60	15	1
60367	7,70	20	1
60368	7,70	25	1
60369	7,80	30	1



### Cortador de bolas oval rizado

Cuillère à pommes forme oval canelée · Kugelausstecher oval, gerippt  
Fruit baller oval fluted · Cortador bolas oval frizado

Ref	€	mm	U.Venta
60372	8,50	20x32,5	1



### Cuchillo vaciador

Couteau pour fruits · Frucht messer  
Fruit knife · Faca para fruta

Ref	€	mm	U.Venta
60399	6,00	20x105	1



### Pelapatatas "Y"

Eplucheur "Y" · "Y" Schäler  
"Y" Peeler · Pela-batatas "Y"

Ref	€	mm	U.Venta	
60377	9,50	55x55	1	Liso · Plane
60378	10,10	55x55	1	Dentado · Serrated



### Pelapatatas "P"

Eplucheur "P" · "P" Schäler  
"P" Peeler · Pela-batatas "P"

Ref	€	mm	U.Venta
60380	6,60	16x55	1



### Pelador cuchilla fija

Éplucheur lame fixe · Schäler Messerfix  
Fix blade peeler · Pela-batatas lâmina fixa

Ref	€	mm	U.Venta
60398	5,20	15x75	1



# LUXE

## Colección



### Cuchillo para queso

Couteaux à fromage · Käsemesser  
Cheese knife kitchen tool · Faca para queijo

Ref	€	cm	L (cm)	U.Venta
62675	11,40	14	28	6



### Espátula lisa

Spatule lisse · Backschaufel  
Spatula · Espátula

Ref	€	cm	L (cm)	U.Venta
62676	9,70	4,3x11	25	6



### Descorazonador

Vide-pommes · Apfelnkerner  
Aple corer · Descarçador

Ref	€	cm	L (cm)	U.Venta
62686	9,90	2x2	20	6



### Cortador de bolas

Cuillère à pommes · Kugelausstecher  
Fruit baller · Cortador de bolas

Ref	€	cm	L (cm)	U.Venta
62683	8,90	3x1	19	6



### Pelapatatas "Y"

Eplucheur "Y" · "Y" Schäler  
"Y" Peeler · Descascador de batatas "Y"

Ref	€	cm	L (cm)	U.Venta
62687	11,60	5x2	18	6



### Pelapatatas "P"

Eplucheur "P" · "P" Schäler  
"P" Peeler · Descascador de batatas "P"

Ref	€	cm	L (cm)	U.Venta
62688	10,60	2x1	20	6



### Pala pastel serrada

Palette à gâteau dentellé · Kuchenschaufel  
Serrated cake shovel · Espátula de bolos c/serrilha

Ref	€	cm	L (cm)	U.Venta
62673	12,60	5,5x13	26	6



### Abre ostras LUXE

Couteau à huîtres · Austermesser  
Oyster opener · Aberto-ostras

Ref	€	L (cm)	U.Venta
62684	12,60	20	1

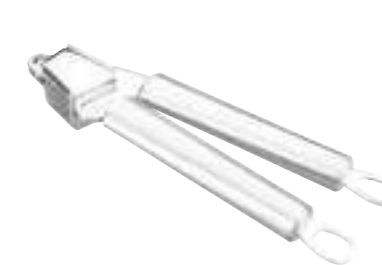

### Prensa ajos

Presse-pail · Knoblauchpresse  
Garlic press · Esmaga-alhos

Ref	€	cm	L (cm)	U.Venta
62685	24,00	3x5	18	6

### Abrelatas

Ouvre-boîte · Dosenöffner  
Can opener · Abre-latas

Ref	€	cm	L (cm)	U.Venta
A 62689	26,50	5x4	20	6
B 63038	22,20	5x4	17	1



# PELADORES

## Colección



### Pelador tomate dentado P

Épluche tomates à dents P · Tomatenschäler, gezackt, P  
P Serrated tomato peeler · Pelador tomate dentado P

Ref	€	L (cm)	U.Venta
60351	14,30	19,5	1



### Pelador tomate dentado Y

Épluche tomates à dents Y · Tomatenschäler, gezackt, Y  
Y Serrated tomato peeler · Pelador tomate dentado Y

Ref	€	L (cm)	U.Venta
60352	14,00	17,5	1



### Descorazonador

Vide tomates · Tomatentkerner  
Tomato core remover · Descorazador

Ref	€	L (cm)	U.Venta
60353	10,70	16,5	1



### Cuchillo dentado

Couteau à dents à tomates · Tomatenmesser, gezahnt  
Serrated tomato knife · Faca dentada

Ref	€	L (cm)	U.Venta
60354	10,60	22	1



### Pelador liso

Éplucheuse plate · Normalen Schäler  
Peeler plain blade · Descascador liso

Ref	€	L (cm)	U.Venta
60547	10,90	12,5	1

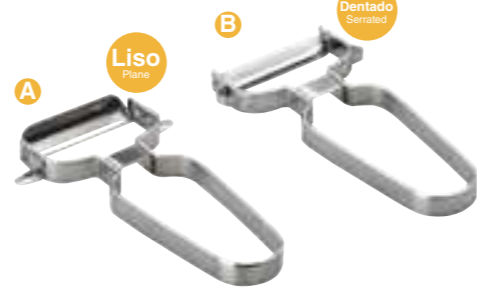

### Pelador

Éplucheuse · Schäler  
Peeler · Descascador

Ref	€	cm	U.Venta
A 60346	11,90	5,5x12	1
B 60347	11,90	5,5x12	1



### Pelador UNITE

Éplucheuse · Schäler  
Peeler · Descascador

Ref	€	L (cm)	U.Venta
A 68197	4,20	14,5	1
B 68198	4,20	14,5	1



### Pelador cerámico Y

Éplucheuse en céramique Y · Y Schäler, Keramik  
Y ceramic peeler · Descascador cerámico Y

Ref	€	cm	U.Venta
60444	4,00	8,5x16,5	6



### Pelador "Y" cuchillas giratorias

Éplucheuse "Y" lames tournantes · "Y" Schäler, rotierende Messer  
"Y" type peeler rotating blades · Descascador "Y" lâminas giratorias

Ref	€	L (cm)	U.Venta
60389	23,50	20	1



### Pelador aguacate

Coupe avocat · Schäler avocado  
Avocado peeler · Descascador abacate

Ref	€	cm	U.Venta
61355	8,60	28x4	1



### Laminador de aguacate

Éplucheuse avocats · Schäler avocados  
Avocado slicer · Descascador abacater

Ref	€	cm	L (cm)	U.Venta
61353	11,80	6,2	24	1

### Pelador de piña

Set coupe ananas · Ananas-Schäler  
Pineapple peeler · Pelador de ananas

Ref	€	Ø (cm)	h (cm)	U.Venta
60392	11,30	10	23	4



New



### Pelador de piña SLIZE

Set coupe ananas · Ananas-Schäler  
Pineapple peeler · Pelador de ananas

Ref	€	Ø (cm)	h (cm)	U.Venta
68806	3,80	9	24	1

**Funcionamiento práctico, sencillo y eficaz.**  
Multifuncional: pela, separa el corazón, corta y extrae la piña fresca en cuestión de segundos.  
Mango ergonómico para girar sin esfuerzo y empujar el descorazonador a través de la piña.  
Desmontable: facilita su limpieza y es apto para el lavavajillas.

Fonctionnement pratique, simple et efficace.  
Multifonctions : épluche, sépare le cœur, coupe et extrait l'ananas frais en quelques secondes.  
Manche ergonomique pour tourner sans efforts et pousser l'extracteur à travers l'ananas.  
Démontable : cela facilite son nettoyage et il est apte pour le lave-vaisselle.

Quick, practical, effective and easy to use.  
Multifunctional: peels, cores, slices and extracts fresh pineapple in a matter of seconds.  
Ergonomic handle for effortlessly twisting and pushing the corer through the pineapple.  
Fully detachable: easy to clean and dishwasher safe.



### Juego cortador-pelador piña con base

Jeu couteau et éplucheur ananas · Messer und Schäler set für ananas  
Set pineapple cutter-peeler with canister · Jogo cortador e descascador de ananas

Ref	€	Ø (cm)	U.Venta
60393	24,60	9	1



ABS plastic  
3 en 1



# PICADORAS

## Colección



ES

- Picadora de mecanismo manual que pica todo tipo de alimentos, como verduras, frutas, jengibre, ajo, cebolla, frutos secos y hierbas.
- Cuchilla de acero inoxidable de máxima calidad.
- Recipiente transparente para visualizar el proceso. Libre de BPA.
- Muy fácil y cómodo de usar gracias a su sistema manual PressTurn.
- Tapa de polietileno antideslizante para facilitar la tarea y evitar desplazamientos.
- Fácil de desmontar y limpiar.

FR

- Hachoir à mécanisme manuel qui hache tout type d'aliments, comme les légumes, les fruits, le gingembre, l'ail, l'oignon, les fruits secs et les herbes.
- Lame en acier inoxydable de la plus grande qualité.
- Récipient transparent. Sans BPA.
- Très facile et pratique à utiliser grâce à son système manuel PressTurn.
- Couvercle antidérapant pour faciliter la tâche et éviter les glissements.
- Facile à démonter et à nettoyer.

EN

- Hand-operated food processor for chopping all types of food, such as vegetables, fruit, ginger, garlic, onion, nuts and herbs.
- Top quality stainless steel blade.
- Transparent jar for easy viewing. BPA free.
- Very simple, easy to use manual PressTurn.
- Non-slip lid to simplify the process and avoid slipping.
- Easy to dismantle and clean.



Diseño compacto  
Compact design



### Picadora manual PRESS

Hachoir manuel · Handschneider  
Manual food chopper · Picador manual

Ref	€	Ø (cm)	h (cm)	U.Venta
62819	35,70	9,4	22,7	1



### Picadora manual

Hachoir manuel · Handschneider  
Manual food chopper · Picador manual

Ref	€	Ø (cm)	h (cm)	U.Venta
62980	31,90	9,5	22	6



### Picaperejil

Hachoir à manivelle pour fines herbes · Kräutermühle, fein  
St. steel fine herbs mincer · Pica-salsa

Ref	€	cm	U.Venta
60334	22,30	13,5x20x7,5	1

Inox



### Picadora de carne manual

Hachoir avec manivelle · Fleischwolf mit handkurbe  
Meat mincer · Picadora de carne manual

Ref	€	cm	U.Venta
60329	123,80	17x12x19	1

Multifuncional: pica, bate y centrifuga  
Mecanismo de manivela  
que requiere muy poca fuerza  
Multifunctional: chop, beat and spin  
Crank mechanism requiring very little force

Sistema TurnCut  
Accionamiento manual de la manivela  
100% estable. Sujeción mediante ventosa  
TurnCut System  
Manual crank operation  
100% stable. Suction cup fastening

Inox ABS  
plástico



### Picadora

Mincer · Fleischwolf  
Hachoir · Picadora

Ref	€	cm	U.Venta
60340	34,70	18x22	1

### Mini picadora-batidora manual

Mini hachoir-fouet manuel · Minizerhacker-Schneebeesen  
Manual mini chooper-whisk · Mini picadora-bateidea manual

Ref	€	Ø (cm)	L	U.Venta
60361	18,10	Ø17x18	1,00	1

# OSO

## Garras

ES

- Fabricadas en acero inoxidable de máxima calidad.
- Diseñadas para desmenuzar y manipular carnes hechas al horno o barbacoa, como pollo, carne de vacuno, pavo, aves, jamón, etc.
- Puntas afiladas para manipular la carne sin esfuerzo. Forma curvada para un mejor agarre y mayor comodidad.
- Mangos ergonómicos de baquelita resistentes al calor, 100% seguros.
- Multifuncional: desmenuza y traslada la carne, facilita la sujeción para cortes con cuchillo, remueve las ensaladas o pastas, etc.
- Fácil de limpiar. Aptos para el lavavajillas.

FR

- Fabriquées en acier inoxydable de la plus grande qualité.
- Conçues pour émincer et manipuler des viandes cuites au four ou au barbecue comme du poulet, du boeuf, de la dinde, de la volaille, du jambon, etc.
- Pointes aiguisées pour manipuler la viande sans effort. Forme courbée pour une meilleure prise en main et un plus grand confort.
- Poignées ergonomiques en bakélite résistantes à la chaleur, 100% sûres.
- Multifonctions : émincer et transférer la viande, faciliter la prise en main pour une découpe au couteau, remuer les salades ou les pâtes, etc.
- Facile à nettoyer. Aptes pour le lave-vaisselle.

EN

- Made of top quality stainless steel.
- Designed for shredding and handling baked or barbecued meats, such as chicken, beef, turkey, poultry, ham, etc.
- Sharp tips for easy handling of meats. Curved shape for better grip and comfort.
- Ergonomic heat-resistant Bakelite handles, 100% safe.
- Multifunctional: perfect for shredding, turning and holding meat in place while cutting it with a knife, ideal for mixing salads or pasta, etc.
- Easy to clean. Dishwasher safe.

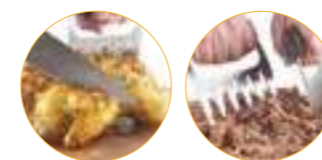

Manipula carnes  
Desmenuza carnes  
Manipulate meat  
Crumble meats

### Garras de oso para carne

Griffes à viande · Fleisch Bärenkrallen  
Bear claws for meat · Garras de urso para carne

Ref	€	cm	U.Venta
38015	12,70	10,5x12	1

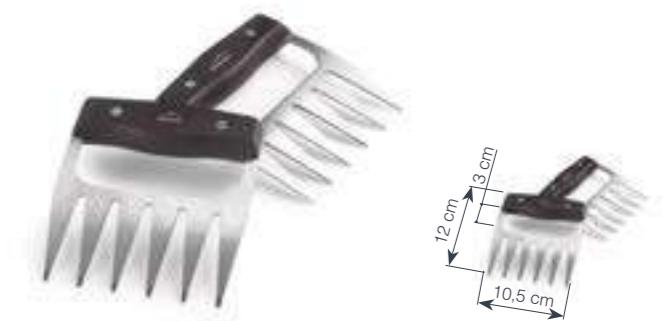

# CORTADORES

## Colección



ES

- Picadora de mecanismo manual que pica todo tipo de alimentos, como verduras, frutas, frutos secos, dátiles, jengibre, ajo, cebolla, hierbas, etc.
- Incluye tres potentes cuchillas ultrarresistentes fabricadas en acero inoxidable de máxima calidad.
- Práctico y muy fácil de usar: con tal solo tirar del asa las cuchillas se activan.
- Corta con precisión y homogéneamente.
- Asa ergonómica y base antideslizante 100% segura.
- Ocupa poco espacio ya que su asa-tirador se pliega sobre la tapa de la picadora.
- Pequeño, compacto y muy fácil de limpiar.

FR

- Hachoir à mécanisme manuel qui hache tout type d'aliments, comme les légumes, les fruits secs, les dattes, le gingembre, l'ail, les oignons, les herbes, etc.
- Il possède trois puissantes lames ultra-résistantes fabriquées en acier inoxydable de la plus grande qualité.
- Pratique et très facile à utiliser : il suffit de tirer de la poignée pour activer les lames.
- Coupe avec précision et de façon homogène.
- Poignée ergonomique et base antidérapante 100% sûre.
- Prend peu de place car sa poignée se replie sur le couvercle du hachoir.
- Petit, compact et très facile à nettoyer.

EN

- Manual chopper that chops all kinds of food, like vegetables, fruit, nuts, dates, ginger, garlic, onion, herbs, etc.
- It includes three ultra-strong blades made of top quality stainless steel.
- Practical and very easy to use: The blades are activated by simply pulling the handle.
- It cuts precisely and evenly.
- It has an ergonomic handle and a 100% safe non-slip base.
- It doesn't take up much space because the handle-pull folds onto the chopper lid.
- It's small, compact and very easy to clean.

Cuchillas SpinPro ultrarresistentes de acero inoxidable  
SpinPro blades ultra-resistant stainless steel



**Cortador manual AFFILATO**  
Coupe manuel · Manuelle Schneider  
Manual chopper · Cortador manual

Ref	€	Ø (cm)	h (cm)	L	U.Venta
60599	24,90	13	14	1,2	1



**Velocidad I · Speed I**  
Corta y pica más grueso  
Cut and chop more coarsely



**Corta alimentos duros**  
It cuts thicker foods



**Velocidad II · Speed II**  
Corta y pica más fino  
Cut and chop more finely



**Corta alimentos blandos**  
It cuts softer foods

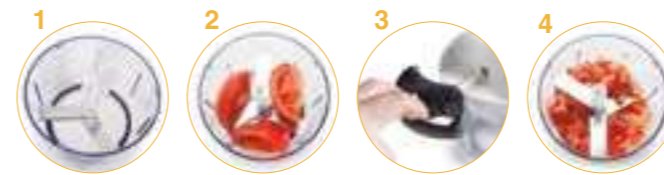

**Pica y corta alimentos en segundos**  
It chops and slices foods in seconds

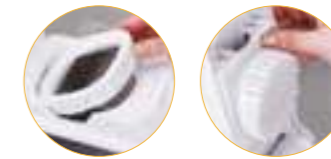

**3 cuchillas (6 - 9 - Rodajas 6 mm)**  
**2 empujadores**  
**Peines de limpieza**  
3 blades (6 - 9 - Slice 6 mm)  
2 pushers  
Cleaning combs

**3 cuchillas ultrarresistentes**  
3 ultra-strong blades

**5 cuchillas ultrarresistentes**  
5 ultra-strong blades

A



B



**Cortador manual SHARP**  
Coupe manuel · Manuelle Schneider  
Manual cutter · Cortador manual

	Ref	€	Ø (cm)	h (cm)	L	U.Venta
A	60299	21,10	12	11	0,5	1
B	60499	22,40	13	14	1,0	1

- 2 en 1: cortador de verduras y cortador para preparar patatas Hasselback.
- Ideal para cortar en rodajas cualquier tipo de alimento como patata, cebolla, tomate, pepino, zanahoria e incluso carne y pescado.
- Mango antideslizante para un agarre firme y pinchos que guían el cuchillo para un corte perfecto y uniforme.
- Fácil de limpiar. Apto para el lavavajillas.

- 2 en 1 coupe-légumes et coupe-pommes de terre pour préparer des pommes de terre Hasselback.
- Idéal pour couper en rondelles tout type d'aliments comme les pommes de terre, les tomates, les concombres, les carottes et même la viande et le poisson.
- Manche antidérapant pour une prise en main ferme et des pointes qui guident le couteau pour une découpe parfaite et uniforme.
- Facile à nettoyer. Convient au lave-vaisselle.

- 2 in 1: vegetable slicer and Hasselback potato slicer.
- Ideal for slicing any type of food such as potatoes, onions, tomatoes, cucumbers, carrots and even meat and fish.
- Non-slip handle for a firm grip and skewers that guide the knife for perfect and even slicing.
- Easy to clean. Suitable for the dishwasher.



**Mango antideslizante**  
Non-slip handle

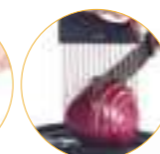

**Cortador de patatas HASSELBACK**

Coupe-pommes de terre Hasselback · Hasselback-Kartoffelschneider  
Hasselback potato slicer · Cortador de batatas Hasselback

Ref	€	cm	h (cm)	U.Venta
68180	9,60	18x10	2,1	1

- Funcionamiento sencillo; insertar el tallo en el agujero que mejor se adapte y deslizar la rama en dirección contraria.
- Contiene agujeros de distinto tamaño:
  - a.- Los pequeños para deshojar hierbas aromáticas como el romero, orégano, tomillo estragón, etc.
  - b.- Los más grandes para separar el tallo más duro que tienen algunas verduras de la hoja como las acelgas, espinacas, col rizada, etc.
- Gracias a la parte más aguda, se pueden cortar las hojas con el mismo utensilio.

- Easy to use. Put the stalk into the hole where it fits best and pull the herb in the opposite direction.
- There are different sized holes:
  - a.- The small holes are for stripping leaves from aromatic herbs like rosemary, oregano, thyme, tarragon, etc.
  - b.- The bigger holes are for separating harder stalks found in some leafy vegetables like chards, spinach, kale, etc.
- With the sharp end you can use the same utensil to cut leaves.



**Parte aguda para cortar**  
Sharp part for cutting



**Separador de hojas**  
Separating leaves



**Deshojador de hierbas aromáticas**

Effeuilleuse à herbes aromatiques · Entblätterer für gewürzkräuter  
Aromatic herb stripper · Desfolhador de ervas aromáticas

Ref	€	cm	U.Venta
61359	6,50	16,5x7,5x2	1



**New**

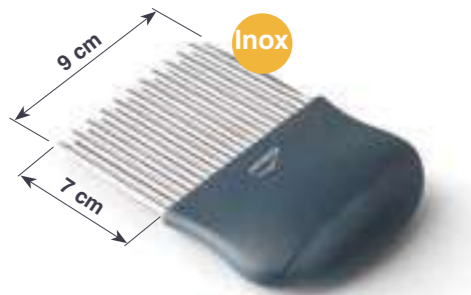

**Cortador de patatas ondulado**  
Coupe-frites ondulé · Kartoffel-Wellenschneider  
Crinkle cut potato slicer · Cortador de batatas ondulado

Ref	€	cm	h (cm)	U.Venta
62895	2,90	14x9,5	2	1

Cuchilla ondulada fabricada en acero inoxidable de gran calidad. Cuchilla estable, resistente y afilada para cortar sin esfuerzo. Mango cómodo, robusto y antideslizante. Multiusos; ideal para cortar patatas, zanahorias, calabacines, queso, etc. Fácil de limpiar. Apto para el lavavajillas.

Lame ondulée fabriquée en acier inoxydable de grande qualité. Lame stable, résistante et aiguisée pour couper sans efforts. Manche confortable, robuste et antidérapant. Multi-usages : idéal pour couper des pommes de terre, des carottes, des courgettes, du fromage, etc. Facile à nettoyer. Compatible avec le lave-vaisselle.

Wavy blade made of high quality stainless steel. Stable, strong and sharp blade for effortless slicing. Comfortable, robust and non-slip handle. Multipurpose: perfect for slicing potatoes, carrots, courgette or cheese, etc. Easy to clean. Dishwasher safe.



- Corta frutas y verduras en forma de tallarines.
- Ideal para calabacín, zanahoria, nabo, patata, remolacha etc.
- Alimentación saludable y baja en hidratos de carbono.
- Cuchillas de acero inoxidable. Se utiliza del mismo modo que un sacapuntas.

· Coupe les fruits et les légumes en forme de tagliatelles.  
· Idéal pour les courgettes, carottes, navets, pommes de terre, betteraves, etc.  
· Alimentation saine et faible en hydrates de carbone.  
· Lames en acier inoxydable. S'utilise comme un taille-crayon.

· Slice fruit and vegetables into noodleshapes.  
· Ideal for courgettes, carrots, turnips, potatoes, beetroot, etc.  
· Healthy and low carbohydrate food.  
· Stainless steel blades. Works just like a pencil sharpener.



**Cortador de verduras manual DOUBLE**

Hachoir de légumes double manuel · Doppelschneidiges Hand Wiegemesser  
Vegetables manual double blade chopper · Corta verduras manual duplo lâmina

Ref.	€	cm	U.Venta
60365	16,60	17x2	10



**Cortahuevos**

Coupe-oeuf · Eirschneider  
Egg cutter · Corta-ovos

Ref	€	Ø (cm)	U.Venta
A 68305	20,00	7	1
B 68306	18,00	10	12
C 68307	35,50	15x10x3,7	1



**Cortador en espiral manual**

Coupe en spirale manuelle · Manueller Spiralschneider  
Manual spiral cutter · Cortador em espiral manual

Ref	€	Ø (cm)	h (cm)	L	U.Venta
60524	18,60	9	22	0,40	1



**Cortador en espiral espagueti**

Coupe en spirale · Spiralschneider  
Spiral cutter · Cortador em espiral

Ref	€	Ø Int. (cm)	Cuchilla L (cm)	U.Venta
60529	4,00	8	5,5	6



**Corta melones-sandias**  
Trancheur à melons · Wassermelonen-Schneider  
Melon cutter-watermelon · Corte os melões-melancia

Ref	€	Ø (cm)	U.Venta
60397	20,10	25,0	1

Guían el cuchillo para un corte perfecto y uniforme  
Guide the knife for perfect and even slicing



**Peine cortacarne**  
Peigne pour coupe viande · Fleischzange  
Meat tong · Pinça/pente corta-carne

Ref	€	cm	h (cm)	U.Venta
60336	19,70	11x30	6,5	6



**Cortabacalao**

Couper la morue · Kabeljau-Schneider  
Cut cod · Corta-bacalhau

Ref.	€	cm	U.Venta
60000	241,70	11x58,5x8	1



**Cortaquesos cuchilla**

Coupe-fromage avec lame · Käsemesser, mit Klinge  
Cheese cutter with blade · Corta-queijos lâmina

Ref	€	cm	h (cm)	U.Venta
60005	28,80	27,5x21	3	1



**Descorazonador manual**  
Vide-pommes manuel · Apfelentkerner  
Manual apple corer · Descoraçador manual

Ref	€	U.Venta
60350	7,70	1

Cuchilla de 6 cm de largo  
6 cm long blade  
Regular de grosor  
Regular thickness



**Laminador de trufa**  
Coupe-Truffes · Truffelschneider  
Truffe-slicer · Laminador trufa

Ref	€	L (cm)	U.Venta
61351	14,40	18	1



**Cortador de queso fresco**

Fromage coupe fil · Draht-Käseschneider  
Cheese wire cutter · Corta-queijos

Ref	€	cm	U.Venta
60004	4,80	17	12
60009	5,30	21	12



**Cortapizza**

Roulette pizza · Pizzaschneider  
Pizza cutter · Corta-Pizza

Ref	€	Ø (cm)	U.Venta
A 60429	5,00	10	12
B 67004	17,50	10	1
C 67028	12,10	10	1
D 67027	5,80	8	6



# TOMATE

## Triturador

Inox ABS SAN LDPE  
 Plastic Plastic Container Polyethylene Tapa/Lid BPA free

ES

- Saca el máximo jugo a los alimentos, libre de pieles y semillas.
- Filtro de acero inoxidable de gran calidad y contenedor de polipropileno, libre de BPA.
- Superversátil: prepara salsas de tomate, purés de patata, mermeladas, conservas, etc. con un único aparato.
- Entrada de alimentación de gran capacidad.
- Dispone de un orificio de salida para desechos.
- 100% estable: sistema de sujeción mediante ventosa.
- Incluye empujador para facilitar y agilizar el procesado.
- Totalmente desmontable y fácil de limpiar.

FR

- Recueillir au maximum le jus des aliments, sans peaux ni pépins.
- Filtre en acier inoxydable de grande qualité et conteneur en polypropylène, sans BPA.
- Très polyvalent: préparer des sauces tomate, des purées, des confitures, des conserves, etc. avec un seul appareil.
- Entrée d'aliments de grande capacité.
- Dispose d'un orifice de sortie pour déchets.
- 100% stable: système de fixation via des ventouses.
- Inclut un poussoir pour faciliter et accélérer le processus.
- Entièrement démontable et facile à nettoyer.

EN

- Designed to get the most juice out of food with no peels or seeds.
- It has a high quality stainless steel filter and a BPA free polypropylene container.
- Extremely Versatile: make tomato sauces, potato purée, marmalade, preserves, etc. with a single appliance.
- High capacity food input
- It has an outlet for waste.
- 100% Stable: it has an attachment system that uses suction cups.
- A pusher is included to make processing food faster and easier.
- It can be completely disassembled and it's very easy to clean.

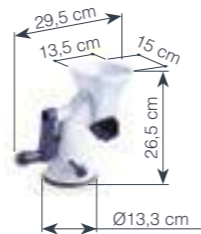

Incluye empujador  
 Salida para desechos  
 Salida de jugo, libre de pieles y semillas  
 Includes pusher  
 Outlet for waste  
 Juice outlet with no peels or seeds

### Triturador manual de tomate

Presse-tomates manuel · Handpresse für Tomaten  
 manual tomato chopper · Triturador manual de tomate

Ref	€	U.Venta
60394	47,20	1



# RALLADORES

## Colección

Inox



ES

- Fabricados en acero inoxidable de máxima calidad. Robustos y altamente resistente.
- Disponen de 4/6 caras de distinto corte para obtener el tipo de rallado deseado: fino, medio, grueso y cortes en rodajas.
- Diseñados para rallar y cortar en rodajas todo tipo de alimentos como queso, verduras, nuez moscada, chocolate, etc.
- Asa ergonómica para un mejor agarre y uso.
- Prácticos y muy fáciles para almacenar.

FR

- Fabriqué en acier inoxydable de la plus grande qualité. Robustes et hautement résistante.
- Disposant de 4/6 faces différentes pour obtenir la coupe et le type de grain souhaité: fin, moyen, épais et différentes coupes en rondelles.
- Conçue pour râper tout type d'aliments comme du fromage, des légumes, de la noix de muscade, du chocolat, etc.
- Poignée ergonomique pour une meilleure prise en main et utilisation.
- Pratique et très facile à ranger.

EN

- Made of top quality stainless steel. Robust and highly resistant.
- Features 4/6 different cutting sides to suit all your grating needs: fine, medium, coarse and slices.
- Designed to grate and slice all kinds of food such as cheese, vegetables, nutmeg, chocolate, etc.
- Ergonomic handle for better grip and use.
- Very practical and easy to use.

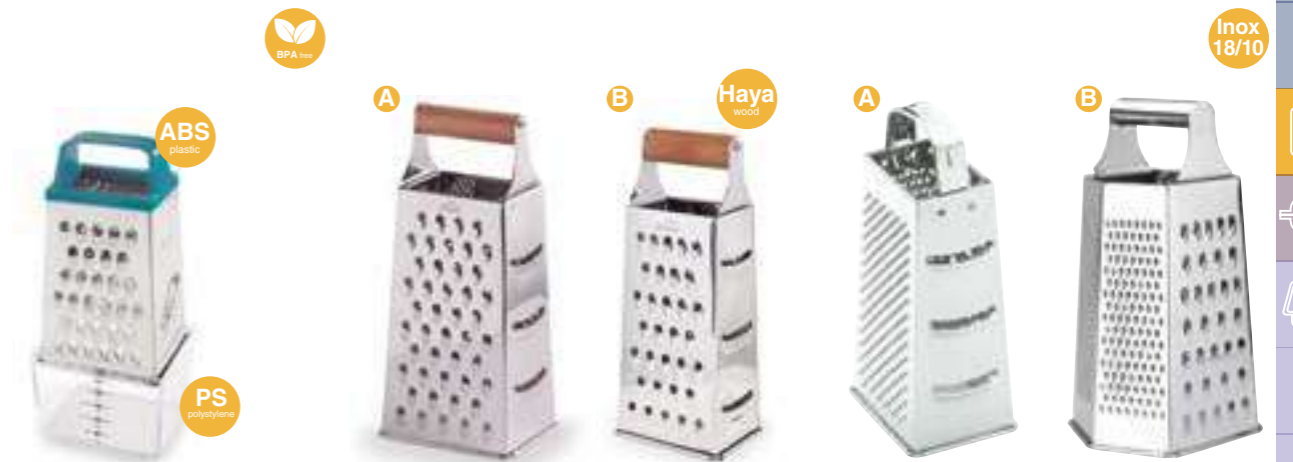

Contenedor de 250 ml. Marcado en ml y cups  
 250 ml container. Marked in ml and cups

### Rallador 4 caras KEEP

Râpe 4 faces avec récipient · 4-seitige Reibe m/Behälter  
 4-sided grater with container · Ralador 4 lados c/recipiente

Ref	€	cm	h (cm)	U.Venta
61363	6,10	8,9X6,5	20,5	61

### Rallador 4 caras WOOD

Râpe 4 faces · 4-seitige Reibe  
 4-sided grater · Ralador 4 lados

Ref	€	cm	h (cm)	U.Venta
A 61364	11,00	11x8,5	24,8	1
B 61365	9,10	9x6,5	22,0	1

### Rallador MULTI

Râpe · Reibe  
 Grater · Ralador

Ref	€	h (cm)	U.Venta
A 60305	7,00	23	6
B 60307	16,10	24	6



### Rallador LUXE

Râpe · Reibe  
Grater · Ralador

	Ref	€	h (cm)	U.Venta
A	61354	27,80	23,5	1
B	61356	28,00	23,0	1



**Inox 18/10**  
2 cilindros intercambiables: fino · grueso  
2 interchangeable cylinders: fine · coarse

### Rallador inox

Hachoir en inox · Käsereibe, Rostfrei  
St. steel cheese grater · Ralador inox com manivela

Ref	€	cm	U.Venta
60335	34,40	13,5x20x10	1



**Inox 18/10**

### Rallador de limón

Râpe muscade · Zitronenreibe  
Grater semi-circular · Ralador de limão

Ref	€	cm	U.Venta
67008	6,00	23x6	12



3 en 1

### Rallador DUAL

Râpe · Reibe  
Grater · Ralador

Ref	€	L (cm)	U.Venta
61360	10,10	31,0	6



4 en 1

### Rallador decorador multiusos

Râpe pour décoration multi-usages · Mehrzweckreibe zum Verziern  
Multipurpose zester · Ralador decorador multiusos

Ref	€	L (cm)	U.Venta
63911	11,30	18,0	1

3 en 1



### Rallador plano 3 usos

Râpe plat · Reibe 3 Nützlichkeit  
Grater 3 uses · Ralador plano 3 usos

Ref	€	cm	U.Venta
60301	7,60	25,5x11	12



### Rallador plano paso grueso

Râpe plat · Reibe, grob  
Grater big hole · Ralador plano passo grosso

Ref	€	cm	U.Venta
60302	7,60	25,5x11	12



### Rallador plano paso fino

Râpe plat · Reibe, fein  
Grater small hole · Ralador plano passo fino

Ref	€	cm	U.Venta
60303	7,60	25,5x11	12



### Rallador

Râpe · Reibe  
Grater · Ralador

	Ref	€	U.Venta	
A	61341	15,60	1	Extra fino · Extra thin
B	61342	15,60	1	Fino · Thin
C	61343	15,60	1	Grueso · Thick
D	61344	15,60	1	Juliana · Julienne



Extremadamente afilado  
Extremely sharp



### Rallador especias mini

Râpe à épices mini · Mini-Reibe Gewürze  
Mini spices grater · Ralador especiarias mini

Ref	€	cm	h (cm)	U.Venta
67032	3,60	11x7	1	6



### Rallador nuez moscada

Râpe à muscade · Musket Reibe  
Nutmeg grater · Ralador noz-moscada

Ref	€	cm	h (cm)	U.Venta
67031	10,30	4,5x3	15	12



### Rallador nuez moscada mini

Râpe à noix de muscade mini · Mini-Musket Reibe  
Mini nutmeg grater · Ralador noz-moscada mini

Ref	€	h (cm)	U.Venta
67009	2,10	14	12



### Rallador largo

Râpe longue · Reibe, lang  
Lengthways grater · Ralador comprimo

	Ref	€	U.Venta	
A	61346	15,60	1	Fino · Thin
B	61347	15,60	1	Medio · Medium
C	61348	15,60	1	Grueso · Thick
D	61349	15,60	1	Fino+Medio · Thin+Medium

# MANDOLINAS

## Colección

Inox	ABS Plastic	AS Plastic	POM Plastic		
------	----------------	---------------	----------------	--	--



ES

- Su cuchilla extremadamente afilada proporciona un corte homogéneo y preciso.
- Corte por accionamiento vertical con una palanca de retroceso automático.
- Procesado de alimentos 5 veces más rápido que el trabajo manual.
- Pie plegable y base con 8 ventosas para mejorar la estabilidad en el uso.
- **SEGURO:** protector contra cortes, no hay contacto directo con las manos durante su uso.
- Dispone de un contenedor que recoge los alimentos cortados.
- Palanca con posición de bloqueo de seguridad, muy seguro para su transporte y almacenaje.

FR

- Sa lame extrêmement affilée confère une coupe homogène et précise.
- Coupe par actionnement vertical avec un levier à retour automatique.
- Traitement des aliments 5 fois plus rapide que via le travail manuel.
- Pied pliable et base avec 8 ventouses pour améliorer la stabilité lors de l'utilisation.
- ASSURANCE: Protection anti-coupures. Pas de contact direct avec les mains pendant l'utilisation.
- Dispose d'un conteneur qui recueille les aliments coupés.
- Levier avec position de blocage de sécurité, très sûr pour le transport et le rangement.

EN

- It's extremely sharp blade enables even and precise cutting.
- Vertically operated cutting with an automatic recoil lever.
- Processes food 5 times quicker than manual cutting.
- Foldable legs and base with 8 suckers to improve stability during use.
- SAFE: Anti-cut protector; no direct contact with hands during use.
- Includes a container that collects the chopped food.
- Lever with safety lock position; very safe for transport and storage.

### 3 tipos de corte · 3 types of cut

4 mm

Rodajas  
Slices



2 mm



8 mm

Juliana  
Julienne



4 mm



4x4 mm

Cubos  
Cubes



Plegable  
Bloqueo de seguridad  
Fold up  
Safety lock position

### Mandolina vertical

Mandoline verticale · Mandoline, Vertikale  
Vertical mandoline · Mandolina vertical

Ref	€	Corte rodaja	Corte juliana	Corte cubos	U.Venta
60460	40,20	0,5 - 8 mm	4 - 8 mm	8x8 mm <sup>(max)</sup> / 0,5x4 mm <sup>(min)</sup>	1

New



garinox®

### Mandolina vertical PRECIS

Mandoline verticale · Mandoline, Vertikale  
Vertical mandoline · Mandolina vertical

Ref	€	Rodaja (mm)	Juliana (mm)	U.Venta
60560	25,60	2 - 4	4 - 8	1

Gira la rueda para seleccionar el espesor de corte o el tipo de juliana que deseas obtener  
Base antideslizante y protector de dedos que evita el contacto con las cuchillas durante su uso  
Turn the wheel to select the thickness of the slice or the type of julienne cut you wish to make  
Non-slip base and finger guard to prevent coming in contact with the blades during usage

New design



8  
Funciones  
Functions

5  
Cuchillas  
Blades

### Mandolina MULTI

Mandoline · Mandoline  
Mandoline · Mandolina

Ref	€	cm	U.Venta
60331	30,90	14,5x34,5	1



5  
Cuchillas  
Blades

### Mandolina LUXE

Mandoline · Mandoline  
Mandoline · Mandolina

Ref	€	cm	U.Venta
60332	117,10	14x42	1



5  
Cuchillas  
Blades

8  
Funciones  
Functions

### Mandolina V

Mandoline · Mandoline  
Mandoline · Mandolina

Ref	€	cm	U.Venta
60356	38,00	13x33,5	1



4  
Cuchillas  
Blades

Cuchillas giratorias  
Rotating blades

### Mandolina SAFE

Mandoline · Mandoline  
Mandoline · Mandolina

Ref	€	cm	U.Venta
60357	126,80	12,5x50	1

# EMBUTIDOS

## Guillotina



### ES

- Diseñada para cortar y rebanar todo tipo de embutidos (Ø 5,5 cm máx.) de forma rápida, segura y sin esfuerzo.
- Cuchilla de acero inoxidable muy afilada de máxima calidad.
- Mango ergonómico que garantiza un agarre fácil y cómodo.
- Máxima seguridad gracias al pasador protector con imán.
- 100% estable. Dispone de 7 almohadillas de goma antideslizantes en la base.
- Apto para el lavavajillas.

### FR

- Conçue pour couper et trancher tout type de saucisson, chorizo, rosette... (Ø 5,5 cm max.) de façon rapide, sûre et sans efforts.
- Lame en acier inoxydable très aiguisée de la plus grande qualité.
- Manche ergonomique qui garantit une prise en main facile et pratique.
- Sécurité maximale grâce à l'arceau de protection avec aimant.
- 100% stable. Dispose de 7 patins en caoutchouc antidérapants sur la base.
- Apte pour le lave-vaisselle.

### EN

- Designed to cut and slice all types of cold meats (Ø 5.5 cm max.) quickly, safely and effortlessly.
- Extremely sharp top-quality stainless steel blade.
- Ergonomic easy grip comfortable handle.
- Includes safety latch with magnet for maximum safety.
- 100% stable. 7 anti-slip rubber pads on the base.
- Dishwasher safe.

**Máxima seguridad: pasador protector con imán**  
**Cuchilla de acero inoxidable muy afilada**  
**Bandeja recoge rebanadas**  
 Maximum safety: Includes safety latch with magnet  
 Extremely sharp top-quality stainless steel blade  
 Tray for collecting the cut slices



### Guillotina para embutidos

Guillotine à saucisson · Wurtschneider  
 Cold meat guillotine · Guillotina para embutidos

Ref	€	cm	h (cm)	U.Venta
60559	21,20	29x19	10,5	1

# MÁQUINAS DE CORTE

## Colección



### ES

- Aumenta la productividad disminuyendo el tiempo de trabajo frente a sistemas convencionales.
- Gama de corte profesional con 4 modelos de corte manual. Con un diseño robusto y ergonómico, gracias a sus cuchillas de acero inoxidable (resistentes a la corrosión), aseguran un corte uniforme y de gran calidad. Ideales para cualquier cocina industrial, su fácil manejo permite obtener un óptimo rendimiento con el mínimo esfuerzo.

### FR

- Augmente la productivité et diminue le temps de travail par rapport aux systèmes conventionnels.
- Gamme de coupe professionnelle avec 4 modèles de coupe manuelle. Avec une conception robuste et ergonomique, notamment grâce aux lames en acier inoxydable (résistantes à la corrosion), ils garantissent une coupe uniforme et de grande qualité. Ils s'adaptent parfaitement aux différents types de cuisine industrielle et la facilité de manipulation permet d'obtenir un rendement optimal avec le moindre effort.

### EN

- Increases productivity by reducing working time when compared to conventional systems.
- Range of professional cutting Utensils with 4 new manual cutting models. With a robust and ergonomic design, its stainless steel (corrosion resistant) blades ensure a smooth and high quality cut. Ideal for any Industrial kitchen, their ease of use enables optimum performance with minimum effort.



### Máquina corta tomates

Machine pour couper tomates · Tomatenschneider  
 Tomato cutter machine · Máquina cortador tomate

Ref	€	Espesor (mm) / Nº rodajas	cm	Kg	U.Venta
60510	248,00	5,5 / 9 rodajas	43x20x21	5,20	1

**Ventosas de sujeción**  
 Gripping suckers



**Colóquelo donde quiera (mesa-pared-tabla)**  
**4 cuchillas diferentes: 7x7 mm / 10x10 mm / 15x15 mm / 8 gajos**  
**Estructura desmontable y fácil limpieza**  
 Place it wherever (table-wall-board)  
 4 different blades: 7x7 mm / 10x10 mm / 15x15 mm / 8 wedges.  
 Collapsible structure and easy cleaning

### Máquina corta patatas y gajos

Machine pour chips trancheuse et wedger · Pommes Frites and Wedger-Schneider  
 Potato chips slicer and wedger machine · Máquina cortador batatas e gomos

Ref	€	Dados (mm)	Gajos	cm	Kg	U.Venta
60513	223,40	7x7 / 10x10 / 15x15	8	26x26x42	8,0	1

**Soporte de sujeción a la superficie de trabajo**  
 Work surface support bracket

**Colóquelo donde quiera (mesa-encimera-tabla)**  
**3 cuchillas diferentes; 6x6 mm / 8x8 mm / 10x10 mm**  
**Estructura desmontable y fácil limpieza**  
 Place it wherever (table-worktop-board)  
 3 different blades; 6x6 mm / 8x8 mm / 10x10 mm  
 Collapsible structure and easy cleaning

### Corta patatas chip 3 cortadores

Coupe-Frites 3 Lames · Pommes Frites-Schneider, 3 Klängen  
 Potato Chips Cutter 3 Blades · Corta-batatas chip 3 cortadores

Ref.	€	Dados (mm)	U.Venta
60343	210,50	6x6 / 8x8 / 10x10	1



**Amortiguadores para evitar golpes al cortar los alimentos.**  
**Asa empujador robusta para un mejor manejo.**  
**Patas de goma para una mejor sujeción.**  
 Shock absorbers to prevent any knocks when cutting food.  
 Robust pusher handle for better handling.  
 Rubber feet for better grip.

### Máquina corta patatas vertical

Machine pour chips trancheuse vertical · Pommes Frites-Schneider vertikal  
 Vertical chips slicer machine · Máquina cortador batatas vertical

Ref	€	Dados (mm)	cm	h (cm)	Kg	U.Venta
60511	176,90	10x10	20x20	48	6,0	1



AL  
Aluminum

AL  
Aluminum

# CARNICERO

## Taco de corte

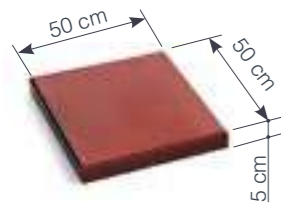

**Gran espesor**  
Great thickness

### Tajo de corte carnicero

Planche à découper la viande · Metzger-Schneidblock  
Butcher Block · Cepo de corte de carnicero

Ref	€	cm	h (cm)	Kg	U.Venta
60578	174,50	50x50	5,0	12	1

**Ideal para cocinas profesionales, carnicerías, pescaderías, etc.**

Perfect for professional kitchens, butcher shops or fishmongers, etc.

- Fabricada en polietileno de alta densidad. Espesor de 5 mm.
- Su dureza le confiere una mayor resistencia a la abrasión, durabilidad y una gran absorción de los golpes.
- Material no poroso que facilita su limpieza. No acumula olores ni sabores.
- Apta para lavavajillas.
- Cumple con todas las garantías sanitarias para la manipulación de alimentos exigidas por la unión europea.

- Fabriquée en polyéthylène de haute densité. Épaisseur de 5 mm.
- Sa dureté lui confère une plus grande résistance à l'abrasion, et une durabilité et une absorption des chocs accrues.
- Matériau non poreux qui facilite son nettoyage. Ne garde ni les odeurs ni les goûts.
- Apte pour le lave-vaisselle.
- Répond à toutes les garanties sanitaires pour la manipulation d'aliments exigées par l'Union Européenne.

- Made of high density polyethylene 5 mm Thick
- Its hardness gives it greater resistance to abrasion, more durability and high impact absorption.
- The non-porous material makes it easy to clean. There is no build-up of odours or flavours.
- Dishwasher safe
- Meets all health guarantee for food handling required by the European Union.

# JAMONEROS

## Colección



**Tacos antideslizantes**  
Non slip plugs

### Jamonero

Support pour jambon · Schinkenhalter  
Ham-support · Suporte presunto

Ref	€	cm	h (cm)	U.Venta
62344	91,90	50x20,5	35,5	1



**Plegable**  
Folding

**Tacos antideslizantes**  
Non slip plugs

### Jamonero abatible

Support pour jambon rabattable · Schinkenhalter, Verstellbar  
Folden ham-support · Suporte presunto abatible

Ref	€	cm	h (cm)	U.Venta
62359	90,30	43x19	5	1

# PROTECCIÓN

## Guantes · Delantal

**2**  
pcs

**Composition:**  
62% PL  
24% PET  
14% GFRP



### Guante protección

Gant de protection · Schutzhandschuh  
Protection glove · Luva de protecção

Ref	€	Talla	Medida	Perim. mano	L (cm)	U.Venta
61101	19,50	M	8	182 mm	24	1
61102	19,50	L	9	192 mm	25	1
61103	19,50	XL	10	204 mm	26	1

Guantes certificados según regulación EPI EU 2016/425 módulo B  
Gloves certified according to regulation EPI EU 2016/425 module B

**Inox**



### Guante cota

Gant en maille · Netz-Handschuh  
Chainman glove · Luva de malha

Ref	€	Talla	Medidas	Perim. mano	Color	U.Venta
39169	139,10	S	7	171 mm	Blanco/White	1
39170	139,10	M	8	182 mm	Rojo/Red	1
39171	139,10	L	9	192 mm	Azul/Blue	1
39172	139,10	XL	10	204 mm	Naranja/Orange	1

**Inox**



### Delantal cota de malla

Tablier en maille · Kettenhemb Schürze  
Metal butcher's apron · Avental de malha

Ref	€	cm	Perímetro	U.Venta
39165	322,40	80x55	95-145 cm	1



**Resistencia a la abrasión**  
Abrasion resistance **3**

**Resistencia al corte**  
Blade cut resistance **4**

**Resistencia al PDM**  
PDM resistance **C**

**Resistencia al desgarro**  
Tear resistance **4**

EN 388:2016+1:2018



344 XC

CE certificate issued by CTC FRANCE

- **Ambidiestros, cómodo y ligero.**
- **NO emplear con sierras giratorias o dentadas.**

- Ambidextres, pratiques et légers.
- NE PAS utiliser avec des scies giratoires ou dentées.

- Ambidextrous, comfortable and light.
- Do NOT use with rotating or toothed saws.



UNE EN 1082

CE Directive 89/686/EEC and EN 1082-1-1996

- **Guante cinco dedos con correa en la muñeca.**
- **Reversible para mano derecha como izquierda.**
- **Diseño de correa extraíble y protección completa de mano.**
- **Fácil lavar y desinfectar.**

- Gant cinq doigts avec courroie au poignet.
- Réversible pour main droite et gauche.
- Conception de courroie extractible et protection complète de la main.
- Facile à laver et désinfecter.

- Five-finger glove with strap on the wrist.
- Reversible for both right and left hand.
- Detachable strap and complete hand protection design.
- Easy to wash and disinfect.

**Ideal para uso en mandolinas profesionales**  
Ideal for use in professional mandolins

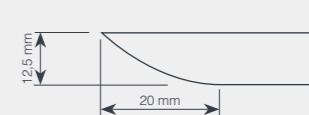

UNE EN 1082

EN ISO 13998: 2003  
NIVEL / LEVEL: 2

- **Ajustable gracias a sus tirantes verticales y horizontales.**
- **Conviene asegurarse de que las medidas del cuchillo empleado no sean inferiores a:**

- Ajustable grâce à ses bandes verticales et horizontales.
- Il convient de s'assurer que les dimensions du couteau utilisé ne sont pas inférieures à :

- Adjustable thanks to its vertical and horizontal straps.
- Care must be taken to ensure that the knife used does not measure less than:

# ETERN

## Colección

Inox **PP**  
Polypropylene **BPA free**



New

ES

### CUCHILLOS

- Fabricados en acero inoxidable de gran calidad.
- Su filo estrecho y delgado permite realizar cortes precisos.
- Mango ergonómico y antideslizante de polipropileno, proporciona un excelente agarre durante el uso.
- Ideal para pelar y cortar cualquier tipo de verduras, frutas, patatas, etc.

### PELADORES

- Pelador universal de doble filo oscilante y microdentado de acero inoxidable de gran calidad (39088-39089-39090).
- Pelador fast de doble filo oscilante muy afilado de acero inoxidable de gran calidad (39091-39092-39093).
- Mango ergonómico y antideslizante de polipropileno, proporciona un excelente agarre durante el uso.
- Ideal para pelar todo tipo de verduras y frutas. Ambidiestro gracias a su doble filo.

FR

### COUTEAUX

- Fabriquées en acier inoxydable de haute qualité.
- Son tranchant étroit et fin permet de réaliser des coupes précises.
- Le manche ergonomique en polypropylène antidérapant offre une excellente prise en main lors de l'utilisation.
- Idéal pour éplucher et couper tout type de légumes, fruits, pommes de terre, etc.

### ÉPLUCHEUR

- Éplucheur universel à double tranchant, oscillant et microdenté, en acier inoxydable de haute qualité (39088-39089-39090).
- Éplucheur à double tranchant oscillant très tranchant en acier inoxydable de haute qualité (39091-39092-39093).
- Le manche ergonomique en polypropylène antidérapant offre une excellente prise en main lors de l'utilisation.
- Idéal pour éplucher toutes sortes de légumes et de fruits. Ambidextre grâce double lame.

EN

### KNIFES

- Made of high quality stainless steel.
- Their narrow and thin cutting edge allows for precise cutting.
- Ergonomic, non-slip polypropylene handle for excellent grip during use.
- Ideal for peeling and cutting any kind of vegetables, fruits, potatoes, etc.

### PEELER

- Universal peeler with double oscillating, micro-serrated cutting edge of high quality st. steel.
- Ergonomic, non-slip polypropylene handle for excellent grip during use.
- Ideal for peeling all types of vegetables and fruits.
- Ambidextrous design featuring a double-edge cutting blade.

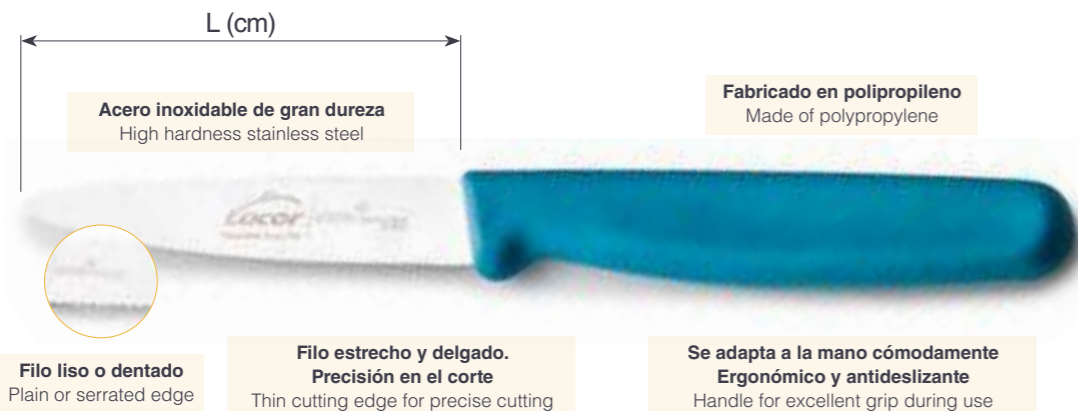

### Set de cuchillos puntilla lisos

Set de couteaux d'office lisses · Messer-Set, spit, glattes  
Sharp knife set-Plain · Conj. de facas multiusos lisos

Ref	€	L (cm)	U.Venta
39080	6,90	9	1
39083	7,10	10	1



### Set de cuchillos puntilla dentados

Set de couteaux d'office dentés · Messer-Set, spit, gezackt  
Sharp knife set-Serrated · Conj. de facas multiusos dentado

Ref	€	L (cm)	U.Venta
39081	6,90	9	1
39084	7,10	10	1



### Set de cuchillos puntilla mix

Set de couteaux d'office mix · Messer-Set, spit, mix  
Sharp knife set-mix · Conj. de facas multiusos mix

Ref	€	L (cm)	U.Venta
39082	6,90	9	1
39085	7,10	10	1



### Set de cuchillos mesa

Set de couteaux de table · Tafelmesser-Set  
Sharp knife set-table · Conj. de facas de mesa

Ref	€	A (cm)	U.Venta
39086	7,10	10,5	1



### Set de cuchillos chuleteros

Set de couteaux à viande · Filetirmesser-Set  
Sharp knife set-choppers · Conj. de facas para carne

Ref	€	A (cm)	U.Venta
39087	7,10	11	1

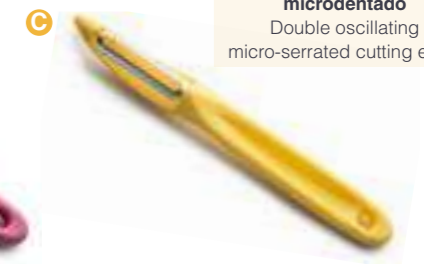

### Pelador Universal

Éplucheur Universel · Universal-Schälmesser  
Universal peeler · Descascador Universal

Ref	€	cm	L (cm)	U.Venta
A 39088	5,70	1x5	17	1
B 39089	5,70	1x5	17	1
C 39090	5,70	1x5	17	1

Doble filo oscilante microdentado  
Double oscillating micro-serrated cutting edge



### Pelador Fast

Éplucheur · Schälmesser  
Peeler · Descascador

Ref	€	cm	L (cm)	U.Venta
A 39091	5,70	4,5x1	11	1
B 39092	5,70	4,5x1	11	1
C 39093	5,70	4,5x1	11	1

Doble filo oscilante liso  
Double oscillating plain cutting edge

# ELITE Colección

## ES

- Fabricado en acero inoxidable de alta calidad con una composición de 5Cr15 y una dureza 55±2.
- Hoja muy afilada y resistente al desgaste. Filo acabado en taper grinding.
- Mango ergonómico y antideslizante en ABS con acero inoxidable, proporciona un excelente agarre durante el uso.
- Ideal tanto para uso doméstico como profesional.
- Diseñado para el corte y manipulación de cualquier tipo de carne, pescado, verdura, fruta, patatas, etc.

## FR

- Fabriqué en acier inoxydable de grande qualité avec une composition de 5Cr15 et une dureté de 55±2.
- Lame très aiguisée et résistante à l'usure. Fil finition « taper grinding ».
- Manche ergonomique et antidérapant en ABS avec acier inoxydable, qui confère une excellente prise en main pendant l'utilisation.
- Idéal aussi bien pour un usage domestique que professionnel.
- Conçu pour couper et manipuler tout type de viandes, poissons, légumes, fruits, pommes de terre, etc.

## EN

- Made of high quality stainless steel with a composition of 5Cr15 and hardness of 55±2.
- Extremely sharp and wear resistant edge Taper ground edge.
- The ABS ergonomic non-slip handle with stainless steel provides an excellent grip during use
- Perfect for home or professional use.
- Designed for cutting and manipulating any kind of meat, fish, vegetables, fruit or potatoes, etc.

## New



### Cuchillo pelador

Couteau éplucheuse · Schäler Messer  
Peeler knife · Faca descascador

Ref	€	cm	U.Venta
38225	9,70	9,0	1



### Cuchillo cocina

Couteau de cuisine · Küchenmesser  
Kitchen knife · Faca cozinha

Ref	€	cm	U.Venta
38224	9,80	12,5	1



### Cuchillo Santoku

Couteau Santoku · Messer Santoku  
Santoku knife · Faca Santoku

Ref	€	cm	U.Venta
38223	15,90	18,0	1



### Cuchillo fileteador

Couteau filet-de-sole · Filiermesser  
Filetting/fish knife · Faca peixe / filetes

Ref	€	cm	U.Venta
38221	14,50	20,0	1



### Cuchillo pan

Couteau à pain · Brotmesser  
Bread knife · Faca de pão

Ref	€	cm	U.Venta
38222	14,50	20,0	1



### Cuchillo Chef

Couteau Chef · Messer Chef  
Chef knife · Faca Chef

Ref	€	cm	U.Venta
38220	15,70	20,0	1

# MASTER Colección

## ES

- Fabricado en acero inoxidable de alta calidad con una composición de 5Cr15 y una dureza 55±2.
- Hoja muy afilada y resistente al desgaste. Filo acabado en taper grinding.
- Mango ergonómico y antideslizante en ABS con acero inoxidable, proporciona un excelente agarre durante el uso.
- Ideal tanto para uso doméstico como profesional.
- Diseñado para el corte y manipulación de cualquier tipo de carne, pescado, verdura, fruta, patatas, etc.

## FR

- Fabriqué en acier inoxydable de grande qualité avec une composition de 5Cr15 et une dureté de 55±2.
- Lame très aiguisée et résistante à l'usure. Fil finition « taper grinding ».
- Manche ergonomique et antidérapant en ABS avec acier inoxydable, qui confère une excellente prise en main pendant l'utilisation.
- Idéal aussi bien pour un usage domestique que professionnel.
- Conçu pour couper et manipuler tout type de viandes, poissons, légumes, fruits, pommes de terre, etc.

## EN

- Made of high quality stainless steel with a composition of 5Cr15 and hardness of 55±2.
- Extremely sharp and wear resistant edge Taper ground edge.
- The ABS ergonomic non-slip handle with stainless steel provides an excellent grip during use
- Perfect for home or professional use.
- Designed for cutting and manipulating any kind of meat, fish, vegetables, fruit or potatoes, etc.

## New



### Cuchillo pelador

Couteau éplucheuse · Schäler Messer  
Peeler knife · Faca descascador

Ref	€	cm	U.Venta
38235	6,20	9,0	1



### Cuchillo cocina

Couteau de cuisine · Küchenmesser  
Kitchen knife · Faca cozinha

Ref	€	cm	U.Venta
38234	6,30	12,5	1



### Cuchillo Santoku

Couteau Santoku · Messer Santoku  
Santoku knife · Faca Santoku

Ref	€	cm	U.Venta
38233	10,60	18,0	1



### Cuchillo fileteador

Couteau filet-de-sole · Filiermesser  
Filetting/fish knife · Faca peixe / filetes

Ref	€	cm	U.Venta
38231	9,30	20,0	1



### Cuchillo pan

Couteau à pain · Brotmesser  
Bread knife · Faca de pão

Ref	€	cm	U.Venta
38232	9,30	20,0	1



### Cuchillo Chef

Couteau Chef · Messer Chef  
Chef knife · Faca Chef

Ref	€	cm	U.Venta
38230	10,50	20,0	1





# PROFESIONAL

## Colección

54-58 MOLYBDÄNSTAHL Mango Antideslizante  
 HRc X 45 Cr Mo V 15 Non-slip long handle knives Dishwasher  
**Acero inoxidable al cromo-molibdeno-vanadio**  
 Chrome-molybdenum-vanadium stainless steel

ES

- Cuchillo estampado
- Fabricado en acero inoxidable al cromo-molibdeno-vanadio X 45 Cr Mo V 15. Dureza de 54-58 HRc
- Cuchillo estable, fuerte y de gran durabilidad
- Mango ergonómico antideslizante, tacto suave Soft Touch

FR

- Couteau estampé
- Fabriqué en acier inoxydable au chrome-molybdène-vanadium X 45 Cr Mo V 15. Dureté de 54-58 HRc
- Couteau stable, robuste et d'une grande durabilité
- Manche ergonomique antidérapant, toucher doux Soft Touch

EN

- Stamped Knife
- Made of X 45 Cr Mo V 15 chromium-vanadium stainless steel. 54-58 HRc Hardness
- A stable, strong and durable knife
- Non-slip ergonomic handle, smooth Soft Touch feel



### Cuchillo CHEF

Couteau de chef · Messer Chef  
 Cook's knife · Faca Chef

Ref	€	cm	U.Venta
49016	6,90	16	12
49021	10,20	21	12
49025	12,00	25	12
49030	13,00	30	12



### Cuchillo cocina

Couteau de cuisine · Küchenmesser  
 Kitchen knife · Faca cozinha

Ref	€	cm	U.Venta
49110	4,80	10	12
49112	4,80	12	12
49116	5,60	16	12
49121	7,20	21	12



### Cuchillo patatero

Couteau office · Gemüsemesser  
 Paring knife · Faca batatas

Ref	€	cm	U.Venta
49185	4,30	8,50	12



### Cuchillo deshuesador

Couteau à désosser · Ausbeinmesser  
 Boning knife · Faca desossador

Ref	€	cm	U.Venta
49014	5,30	14	12



### Cuchillo jamonero

Couteau à jambon · Schinkenmesser  
 Ham knife · Faca de presunto

Ref	€	cm	U.Venta
49024	8,20	26	12



### Cuchillo pan

Couteau à pain · Brotmesser  
 Bread knife · Faca de pão

Ref	€	cm	U.Venta
49027	7,40	21	12



### Tenedor de trinchar

Fourchette de chef · Tranchiergabel  
 Cook's fork · Garfo de trinchar

Ref	€	cm	U.Venta
49017	6,40	18	12



### Cuchillo Santoku

Couteau Santoku · Messer Santoku  
 Santoku knife · Faca Santoku

Ref	€	cm	U.Venta
49210	6,40	10	12
49212	7,80	12	12
49216	10,70	16	12

# CERAMIC

## Colección

CZ 87 Mango Antideslizante  
 Zirconia HRc Non-slip long handle knives Dishwasher

ES

- Mango ergonómico antideslizante, con un diseño moderno e innovador.
- Resistentes, ligeros e higiénicos.
- NO oxida los alimentos.
- El filo se mantiene hasta diez veces más que los cuchillos convencionales.

FR

- Manche ergonomique antidérapant, le tout avec un design moderne et novateur.
- Résistants, légers et hygiène.
- NO oxyde alimentaire.
- Le tranchant reste aiguisé jusqu'à dix fois plus longtemps que les couteaux conventionnels.

EN

- Ergonomic non-slip handles, modern and innovative design.
- Resistant, light and hygiene.
- NO oxidizes food.
- The edge remains sharp up to ten times longer with conventional knives.



Con funda protectora  
 With protective sheath



Apto para cuchillos cerámicos e inoxidables  
 Suitable for knives ceramic and stainless

### Chaira DIAMANTE

Fusil à affûter · Wetzstahl  
 Sharpening steel · Fusil

Ref	€	cm	U.Venta
39075	35,60	21	1

### Cuchillo cocina

Couteau de cuisine · Küchenmesser  
 Kitchen knife · Faca cozinha

	Ref	€	cm	U.Venta
A	39208	10,70	8	1
B	39210	11,70	10	1
C	39212	19,80	12	1
D	39215	25,70	15	1
E	39218	38,10	18	1
F	39213	23,80	12	1

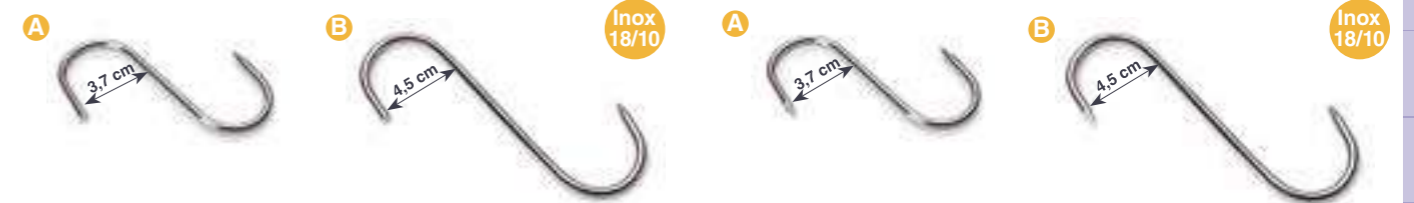

### 6 ganchos carnicero 1 punta

6 crochets de boucher 1 conseil · 6-Tlg Metzgerhaken, 1 spitze  
 6 butchers hook 1 point · 6 ganchos de carnicero 1 punta

	Ref	€	Ø (mm)	L (cm)	U.Venta
A	39043	11,70	5	12,5	4
B	39044	18,10	5	18,5	1

### 6 ganchos carnicero 2 puntas

6 crochets de boucher 2 conseils · 6-Tlg Metzgerhaken, 2 spitzen  
 6 butchers hook 2 points · 6 ganchos de carnicero 2 puntas

	Ref	€	Ø (mm)	L (cm)	U.Venta
A	39047	11,80	5	12,5	4
B	39048	18,30	5	18,5	1

# CORTAQUESOS

## Colección

Acero inoxidable 54-58  
X 50 Cr Mo V 15 HRc  
Acero inoxidable al cromo-molibdeno-vanadio  
Chrome-molybdenum-vanadium stainless steel

ES

- Cuchillos de hoja recta y acodada (39100) / hoja recta (39101) fabricados en acero inoxidable de alta calidad.
- Diseñados para cortar en diferentes tamaños y formas cualquier tipo de queso, ofreciendo un corte preciso, rápido y seguro.
- 39100: Doble empuñadura ergonómica de polioximetileno (POM) con remaches de acero inoxidable.
- 39101: Doble empuñadura ergonómica de polipropileno texturizado y antideslizante.
- Garantizan un agarre cómodo y eficaz.
- Se precisa de menor fuerza que los cortes con cuchillos convencionales.

FR

- Couteau à lame droite et coudée (39100) / lame droite (39101) fabriquées en acier inoxydable de grande qualité.
- Conçu pour couper en différentes tailles et formes tous types de fromage, offrant une découpe précise, rapide et sûre.
- 39100: Double manche ergonomique en polypropylène (POM) avec rivets en acier inoxydable.
- 39101: Double manche ergonomique en polypropylène texturé et antidérapant.
- Garantit une prise en main pratique et efficace.
- Requiert moins de force que pour les coupes réalisées avec des couteaux conventionnels.

EN

- Knife with a straight offset blade made of high quality stainless steel .
- Designed to slice any type of cheese into different sizes and shapes, cutting it accurately, quickly and safely.
- 39100: Ergonomic polyoxymethylene (POM) double handle with stainless steel rivets.
- 39101: Textured non-slip polypropylene double handle.
- Guarantees a comfortable, effective grip.
- Requires less strength than with traditional knives.

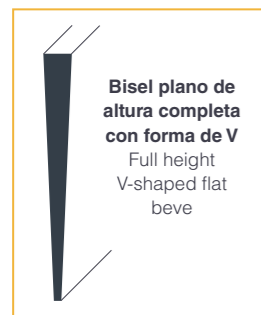

Bisel plano de altura completa con forma de V  
Full height V-shaped flat bevel

### Taper Grinding

Reducción uniforme de la hoja desde el lomo consiguiendo un filo fuerte y duradero.  
Gradually reduction width from the spine resulting in a strong and durable cutting edge.

## New

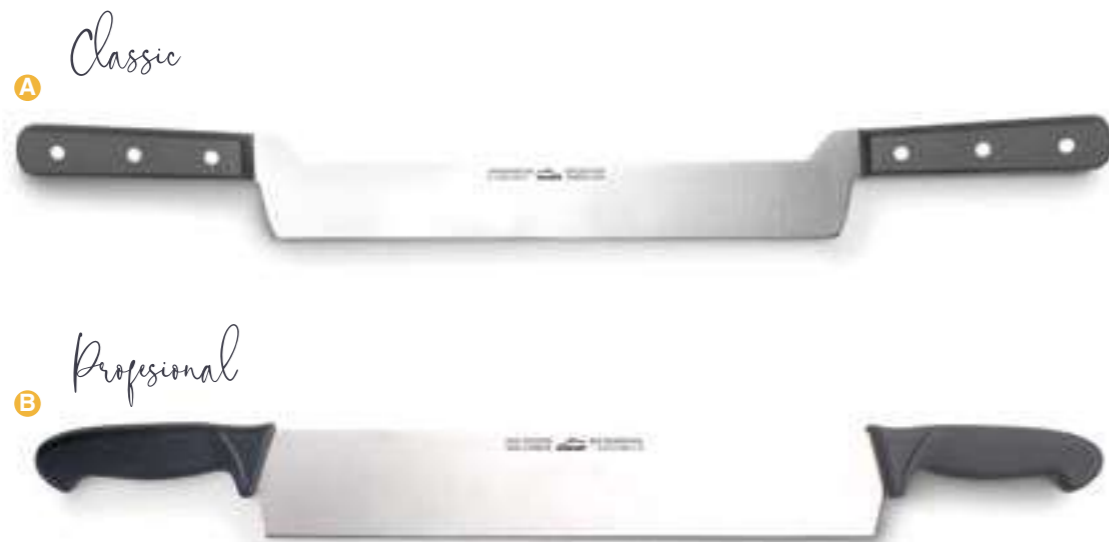

### Cuchillo cortaquesos

Couteau à fromage · Käseschneidemesser  
Cheese slicing knife · Faca para cortar queijo

	Ref	€	cm	U.Venta
A	39100	45,20	30	1
B	39101	41,50	40	1

# TIJERAS

## Colección

Inox



Ambidiestro  
Ambidextrous

Sistema de cierre de seguridad  
Safety closure system

Hojas microdentadas curvadas, extremadamente afiladas y duraderas

Micro-serrated curved blades that are extremely sharp and long-lasting

### Tijeras para aves INOX

Ciseaux à volaille · Geflügelschere  
Poultry shears · Tesouras para aves

Ref	€	L (cm)	U.Venta
60066	35,20	25	1



### Tijeras para aves BLACK

Ciseaux à volaille · Geflügelschere  
Poultry shears · Tesouras para aves

Ref	€	cm	U.Venta
60001	18,80	7,5x27	12

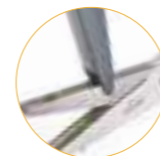

Protector y cepillo de limpieza  
Protector and cleaning brush



Soporte magnético  
Magnetic holder



### Tijeras 5 cortes

Ciseaux 5 coupe · 5-fach Schneideschere  
5 Cuts vegetable scissor · Tesouras 5 cortes

Ref	€	cm	U.Venta
60022	8,50	27x13x3	6

- 1.- Tijeras · Scissors
- 2.- Abrebotellas · Unscrew
- 3.- Cascanueces · Nut cracker

50-54  
HRc

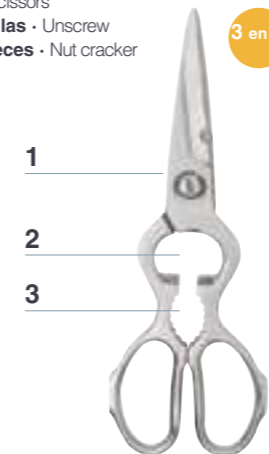

### Tijeras profesional INOX

Ciseaux profesional · Geflügelschere Profesional  
Professional scissors · Tesouras profesional

Ref	€	cm	U.Venta
38010	21,80	7,0x20	12

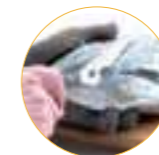

2 en 1



### Tijera-desescamador

Ciseaux ecailleur · Schere-Fischentschupper  
Scissors-scrapper · Tesoura-raspador

Ref	€	L (cm)	U.Venta
60061	5,90	23,00	1

### Tijeras de cocina MAGNETIC

Ciseaux pour cuisine · Küchenschere  
Kitchen shears · Tesouras de cozinha

Ref	€	L (cm)	U.Venta
60059	10,00	21,5	6

### Tijeras de cocina GREY

Ciseaux pour cuisine · Küchenschere  
Kitchen shears · Tesouras de cozinha

Ref	€	cm	U.Venta
60018	10,70	8,5x21	1
60023	10,80	8,5x24	1

# SOPORTES CUCHILLOS

## Colección



ES

- Potente imán en el interior para sujetar con seguridad los cuchillos, tijeras y otros artículos metálicos.
- Incluyen un set de montaje para instalar el soporte de cuchillos sobre cualquier tipo de pared.

FR

- Puissant aimant à l'intérieur pour tenir en toute sécurité les couteaux, les ciseaux et tout autre ustensile métallique.
- Inclut un set de montage pour installer le support à couteaux sur tout type de mur.

EN

- It has a powerful magnet inside for safely holding knives, scissors or other metal items.
- Installation hardware for mounting the support on any kind of wall is included.

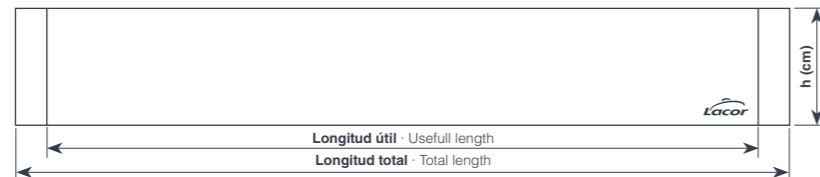

Madera caucho  
Rubber wood

Potente imán  
Powerful magnet

Potente imán  
Powerful magnet

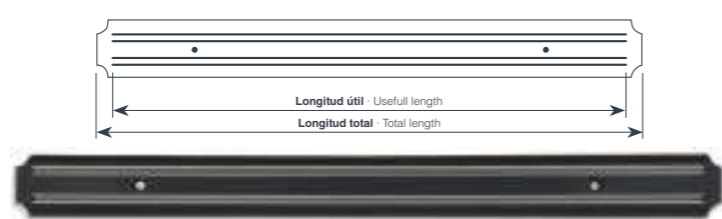

Parte trasera del soporte · Back of the support

### Soporte magnético cuchillos WOOD

Support magnétique pour couteaux · Magnethalterung für Messer  
Magnet support for knives · Suporte magnético de facas

Ref	€	Total (cm)	h (cm)	Útil (cm)	U.Venta
39108	27,10	36	6	33	1
39109	31,70	45	6	42	1

### Soporte magnético cuchillos BLACK

Support magnétique pour couteaux · Magnethalterung für Messer  
Magnet support for knives · Suporte magnético de facas

Ref	€	Total (cm)	Útil (cm)	U.Venta
39008	8,90	38	35,0	12
39009	10,80	55	52,3	12

# TACOS CUCHILLOS

## Colección



New

ES

- Bloques cilíndricos fabricados en polipropileno con recubrimiento TPR y acabado en color blanco mate (39037) / metalizado (39038).
- Diseñados para almacenar cuchillos de filo liso, filo dentado y tijeras.
- Aptos para cuchillos de hasta 20 cm (39037) / 21 cm (39038) de longitud de hoja.
- Varillas interiores de fibras de polipropileno (39037).
- Las ranuras separan los bordes de los filos sin tocarse ni rayarse entre sí (39038).
- Protegen los bordes de los filos y mantiene los cuchillos más afilados durante más tiempo.
- Máxima estabilidad y seguridad.
- Desmontables para facilitar la limpieza. Aptos para el lavavajillas.

FR

- Bloc cylindrique fabriqué en polypropylène avec un revêtement TPR et une finition blanc mat (39037) / métallisé (39038).
- Conçu pour ranger des couteaux à fil lisse, à fil denté et des ciseaux.
- Compatibles avec des couteaux jusqu'à 20 cm (39037) / 21 cm (39038) de longueur de lame.
- Tiges intérieures en fibre de polypropylène (39037).
- Les rainures séparent les bords des fils, évitant ainsi qu'il se touchent ou se rayent entre eux (39038).
- Protège les bords des fils et maintient les couteaux plus affilés pendant plus longtemps.
- Máxima estabilidad y seguridad.
- Démontables pour faciliter le nettoyage. Lavables au lave-vaisselle.

EN

- Cylindrical polypropylene knife holder with TPR coating and matte white finish (39037) / metallised (39038).
- Designed to hold smooth-edged knives, serrated knives and scissors.
- Suitable for knives with blade lengths up to 20 cm (39037) / 21 cm (39038).
- Inner polypropylene fibre rods. (39037).
- The slots separate the edges of the blades and prevent them from touching or scratching each other (39038).
- Protects cutting edges and keeps knives sharper for longer.
- Maximum stability and safety.
- Removable for easy cleaning. Dishwasher safe.

White



Varillas de fibras  
Fibre rods

A



TitanPro



Ranuras separadoras  
Slots separators

B



### Taco de cuchillos

Bloc à couteaux · Messerblock  
Knife block · Taco para facas

Ref.	€	Ø (cm)	h (cm)	U.Venta
A 39037	14,50	11	22,0	1
B 39038	13,60	13	22,8	1

# AFILADORES CUCHILLOS

## Colección



New

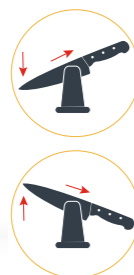

**Primera fase**  
Afilado grueso  
First phase  
Coarse sharpening

**Segunda fase**  
Pulido final o  
afilado diario  
Second phase  
Final honing or  
daily sharpening

### Afilador de cuchillos VERTICAL

Affûteuse de couteaux · Schärmaschine  
Knives sharpener · Afiador de facas

Ref	€	cm	h (cm)	U.Venta
39263	10,60	9,5x5,5	9,5	1

- Diseñado para alar y pulir cuchillos de lo liso o dentado.
- Dos fases de alado: primera fase para un alado grueso, para cuchillos más deteriorados. Segunda fase para el pulido final o alado diario.
- Ángulo de alado regulable: garantiza un lo renovado y efectivo.
- 100% preciso y seguro. Tamaño compacto. Base antideslizante.

- Conçu pour aiguiser et polir des couteaux à fil lisse ou denté.
- Deux phases d'aiguisage : première phase pour un aiguisage épais, pour les couteaux les plus abîmés. Deuxième phase pour le polissage final ou l'aiguisage quotidien.
- Angle d'aiguisage réglable : garantit un fil renoué et efficace.
- 100% précis et sûr. Taille compacte. Base antidérapante.

- Designed for sharpening and honing knives with a smooth or serrated edge.
- Two sharpening phases: first phase for coarse sharpening of blunt blades. Second phase for final honing or daily sharpening.
- Adjustable sharpening angle: guarantees a renewed, much sharper edge.
- 100% precise and safe. Compact size. Non-slip base.

New



### Afilador de cuchillos MINI

Affûteuse de couteaux · Schärmaschine  
Knives sharpener · Afiador de facas

Ref	€	cm	h (cm)	U.Venta
39264	7,40	10x5,2	4,5	1

- Eficaz afilador manual compacto. Diseño ergonómico.
- 2 ranuras de alado: 1.- Ranura de carburo de tungsteno: afilado grueso para las hojas más deterioradas. 2.- Ranura cerámica: pulido final o afilado diario.
- 2 posiciones de afilado para mayor comodidad.
- Afilado óptimo en pocas pasadas.
- Ligero y manejable: uso cómodo, sencillo y seguro.
- Base antideslizante. Fácil de transportar y guardar.

- Aiguiser manuel compact et efficace. Design ergonomique.
- 2 rainures d'aiguisage: 1.- Rainure en carbure de tungstène : Aiguisage épais pour les lames les plus abîmées. 2.- Rainure céramique : Polissage final ou aiguisage quotidien.
- 2 positions d'aiguisage pour une utilisation plus pratique.
- Aiguisage optimal en quelques mouvements.
- Léger et maniable : utilisation pratique, simple et sûre.
- Base antidérapante. Facile à transporter et à ranger.

- Highly effective, compact manual sharpener. Ergonomic design.
- 2 sharpening slots: 1.- Tungsten carbide slot: coarse sharpening of blunt blades. 2.- Ceramic slot: final honing or daily sharpening.
- 2 sharpening positions for added comfort.
- Optimum sharpening in just a few strokes.
- Lightweight and practical: convenient, simple and safe to use.
- Non-slip base. Easy to transport and store.



Base antideslizante  
Non-slip base



Orientación de afilado  
Sharpening orientation



### Afilador de cuchillos DUAL

Affûteuse de couteaux · Schärmaschine  
Knives sharpener · Afiador de facas

Ref	€	cm	U.Venta
39266	18,70	21,5x4,5x9	1



### Afilador de cuchillos eléctrico TitanPRO

Affûteuse de couteaux électrique · Elektrische Schärmaschine  
Electric knife sharpener · Afiador de facas electrónico

Ref	€	U.Venta
69341	39,10	1



Ruedas de Alundum blanco  
White alundum wheel



### Afilador de cuchillos eléctrico ROND

Affûteuse de couteaux électrique · Elektrische Schärmaschine  
Electric knife sharpener · Afiador de facas electrónico

Ref	€	U.Venta
69141	32,10	1

- Afila cuchillos de filo liso.
- 2 zonas de afilado: afilado estándar y afilado alta precisión.
- Cada zona consta de: 2 discos de acero de carburo duro (grosso) para vaciar bordes. 2 discos de cerámica fina para terminar el borde.
- Fácil de usar, empuje el filo en un ángulo de 90° con una ligera presión.
- Asa con goma y ranuras para los dedos que proporciona un manejo sencillo y seguro.

- Aigüiseur pour lames lisses.
- 2 zones d'affûtage : affûtage standard et affûtage de haute précision.
- Chaque zone est composée de : 2 disques en acier au carbone dur (épais) pour restaurer le fil. 2 disques en céramique fine pour terminer le fil.
- Facile à utiliser : pousser la lame à un angle de 90° avec une légère pression.
- Poignée avec caoutchouc et rainures pour les doigts qui confère une prise en main simple et sûre.

- Sharpen smooth blade knives.
- 2 sharpening zones: standard sharpening and high precision sharpening.
- Each zone consists of: 2 thick carbide steel rods for cleaning up edges. 2 thin ceramic rods for honing edges.
- Easy to use: push the knife at a 90° angle using light pressure.
- Rubber handle with finger grooves for safe and easy use.

Ref: 69341

**Características · Characteristics:**  
Tensión · Voltage: 220-240 V; 50-60 Hz  
Potencia · Power: 60 W  
Dimensiones · Sizes: 17x8x10 cm  
Peso · Weight: 0,60 kg

- Permiten mantener los utensilios en perfecto estado.
- Diseño elegante, acabado metalizado.
- Dispone de diferentes ranuras para poder afilar distintos tipos de utensilios como cuchillos, tijeras o destornilladores de punta plana.
- El motor gira a la velocidad óptima para que el afilado de los utensilios sea preciso y duradero.
- 100% seguro: en su base se incluyen cuatro ventosas de fijación para evitar que el afilador se mueva durante su uso.

- Permet de maintenir les ustensiles en parfait état.
- Design élégant, finition métallisée.
- Dispose de différentes rainures pour pouvoir aiguiser différents types d'ustensiles tels que des couteaux, des ciseaux ou des tournevis.
- Le moteur tourne à une vitesse optimale pour que l'aiguisage des ustensiles soit précis et durable.
- 100% antidérapant : sa base possède quatre ventouses de fixation pour éviter que l'aigüiseur bouge pendant son utilisation.

- Keeping kitchen utensils in perfect condition.
- Elegant design, metallic finish.
- It has different grooves for sharpening different utensils, like knives, scissors and flat-head screwdrivers.
- The motor spins at the optimal speed for precise and long lasting sharpening.
- 100% safe. There are four suction cups on the base to keep the sharpener from moving during use.

Ref: 69141

**Características · Characteristics:**  
Tensión · Voltage: 220-240 V; 50 Hz  
Potencia · Power: 60 W  
Dimensiones · Sizes: 173,5x15x9 cm  
Peso · Weight: 0,64 kg



### Afilador de cuchillos eléctrico PRO

Affûteuse de couteaux électrique · Elektrische Schärmaschine  
Electric knife sharpener · Afiador de facas electrónico

Ref	€	U.Venta
69261	124,20	1

Ref: 69261

#### Características · Characteristics:

**Tensión** · Voltage: 220-240 V; 50-60 Hz  
**Potencia** · Power: 180 W  
**Dimensiones** · Sizes: 32x11,5x210 cm  
**Peso** · Weight: 2,20 kg

Fase 1 Fase 2 Fase 3

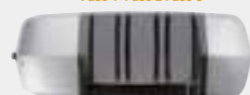

**Fase 1: Alta abrasividad** · high abrasiveness  
**Fase 2: Afilado fino** · thin sharp  
**Fase 3: Microafilado** · micro-sharp



### Afilador de cuchillos eléctrico MOUSE

Affûteuse de couteaux électrique · Elektrische Schärmaschine  
Electric knife sharpener · Afiador de facas electrónico

Ref	€	U.Venta
60359	49,10	1

Ref: 60359

#### Características · Characteristics:

**Tensión** · Voltage: 220-240 V; 50-60 Hz  
**Potencia** · Power: 180 W  
**Dimensiones** · Sizes: 16x11x7,5 cm  
**Peso** · Weight: 20,56 kg



**Cuchillos lisos** · Smooth knives  
**Rejilla salida viruta** · Chip outlet grid

## ABRELATAS Colección



Altura máx. de lata: 30 cm · Maxime height of caniste: 30 cm

### Abrelatas de mesa profesional

Ouvre-boîte de table professionnel · Profe-Dosenöffner für Tisch  
Professional table tin opener · Abre-latas de mesa profesional

	Ref.	€	U.Venta
A	63005	128,20	1
B	63015	189,00	1



### Abrelatas

Ouvre-boîte · Dosenöffner  
Can opener · Abre-latas

	Ref	€	cm	L (cm)	U.Venta
A	62689	26,50	5x4	20	6
B	63038	22,20	5x4	17	1

## TABLAS DE CORTE Colección



ES

- **Tabla de corte fabricada en fibra de madera, materiales naturales y ecológicos.**
- **Duradera, resistente, indeformable y anti-bacteriana.**
- **Las fibras de madera ayudan a mantener el filo de los cuchillos afilado durante más tiempo.**
- **Su diseño permite darle un doble uso, tanto para la cocina como para el servicio en mesa y se pueden usar por ambos lados.**
- **GRIPsystem, pies singulares fabricados en silicona para utilizar las tablas en cualquier superficie sin riesgo de deslizamiento.**
- **El orificio es perfecto para colgar la tabla y facilitar su almacenaje.**
- **Fácil de limpiar gracias a su acabado liso, no poroso.**
- **Apta para el lavavajillas.**

FR

- Planche à découper fabriquée en fibres de bois, un matériau naturel et écologique.
- Durable, résistante, indéformable et antibactérienne.
- Les fibres de bois aident à maintenir le fil des couteaux aiguisés plus longtemps.
- Sa forme permet de lui donner un double usage, à la fois pour la cuisine et pour le service à table, et elle est utilisable des deux côtés.
- **GRIPsystem**, pieds exclusifs en silicone pour utiliser les planches sur n'importe quelle surface sans risque de glisser.
- L'orifice est parfait pour suspendre la planche et faciliter son rangement.
- Facile à nettoyer grâce à sa finition lisse, non poreuse.
- Elle est apte pour le lave-vaisselle.

EN

- Chopping board made from wood fibre, a natural and eco-friendly material.
- Durable, resistant, anti-bacterial and its shape doesn't warp.
- The wood fibres help keep the knife blade sharper for longer.
- Its design allows you to use both for the kitchen and for serving food on the table.
- **GRIPsystem**, exclusive feet made of silicone to use the boards on any surface without risk of slipping.
- The hole is perfect for hanging the board and it makes it easier to store.
- It's easy to clean thanks to its smooth, non-porous finish.
- It's suitable for washing machines.



### Tabla de corte BLACK

Planche à découper · Schneidebrett  
Cutting board · Tábua de corte

Ref	€	cm	e (mm)	U.Venta
60580	18,20	30x21,5	6	1
60581	24,50	37x27,5	6	1
60582	34,80	44x32,5	6	1



### Tabla de corte NOGAL

Planche à découper · Schneidebrett  
Cutting board · Tábua de corte

Ref	€	cm	e (mm)	U.Venta
60586	16,70	26,5x19,5	6	1
60587	21,10	30x23,5	6	1
60588	32,90	40x30	6	1

# TABLAS DE CORTE MADERA

## Colección



ES

- Ideales para cortar todo tipo de alimentos.
- Perfectas para colocar sobre la encimera de la cocina.
- Madera tratada con un revestimiento protector y antibacteriana.
- Diseñada para cuidar y conservar el filo de los cuchillos.
- Ligeras y resistentes. Higiénicas y fáciles de limpiar.

FR

- Idéales pour couper tout type d'aliments.
- Parfaites pour installer sur le plan de travail de la cuisine.
- Bois traité avec un revêtement protecteur et antibactérien.
- Conçues pour prendre soin et préserver le fil des couteaux.
- Légères et résistantes. Hygiéniques et faciles à nettoyer.

EN

- Ideal for cutting any type of food.
- Perfect for placing on kitchen counters.
- The wood is treated with a protective antibacterial finish.
- Designed to conserve and protect the edges of your knives.
- Lightweight and strong. Hygienic and easy to clean.

Bambú  
Bamboo



### Tabla de corte para pan

Planche à découper pain · Schneidebrett brot  
Bread cutting board · Tábua de corte pão

Ref	€	cm	h (cm)	U.Venta
60487	28,70	40x30	2	1

Bambú  
Bamboo



### Tabla de corte pan oval

Planche à découper pain ovale · Schneidebrett oval brot  
Oval bread cutting board · Tábua de corte pão oval

Ref	€	cm	h (cm)	U.Venta
60491	35,80	40x27	3	1

Bambú  
Bamboo



### Tabla de corte pan

Planche à découper pain · Schneidebrett brot  
Bread cutting board · Tábua de corte pão

Ref	€	cm	h (cm)	U.Venta
60495	22,60	50x15	2	1

Bambú  
Bamboo



### Tabla de corte DUAL

Planche à découper · Schneidebrett  
Cutting board · Tábua de corte

Ref	€	cm	h (cm)	U.Venta
60492	36,60	39,5x38	4	1

Bambú  
Bamboo



### Set 3 tablas de corte

Set 3 planches à découper · Set 3 Schneidebrett  
3 cutting boards set · Conjunto 3 tábuas de corte

Ref	€	cm	U.Venta
60523	17,80	20x15	1
		28x22	
		33x25	

Madera  
caucho  
Rubber  
wood

Las fibras colocadas verticalmente, mantienen el filo de los cuchillos

The fibres placed vertically, maintain the edge of the knives



### Tabla de corte RUBBER WOOD

Planche à découper · Schneidebrett  
Cutting board · Tábua de corte

Ref	€	cm	h (cm)	U.Venta
60488	35,00	33x25	4	1
60485	68,40	53,3x32,8	4	1

Madera  
caucho  
Rubber  
wood

Inox



### Tabla de corte COLLECT GN 2/3

Planche à découper · Schneidebrett  
Cutting board · Tábua de corte

Ref	€	Tabla (cm)	Cubeta (cm)	Cubeta (L)	U.Venta
60592	71,00	41,5x34x7	-	-	1
*66540Z	21,70	-	35,4x32,5x4	3,50	1

\* Apta cubeta inox 18/10 (66540) · Suitable for 18/10 stainless steel tray (66540)



### Tabla de corte COLLECT 2xGN 1/2

Planche à découper · Schneidebrett  
Cutting board · Tábua de corte

Ref	€	Tabla (cm)	Cubeta (cm)	Cubeta (L)	U.Venta
60591	99,50	61,5x34x7	-	-	1
*66240Z	11,50	-	26,5x32,5x4	2,5 x 2	1

\* Apta cubeta inox 18/10 (66240) · Suitable for 18/10 stainless steel tray (66240)

- Práctica tabla de corte con una o dos cubetas de acero inoxidable ocultas completamente extraíbles.
- Las fibras colocadas verticalmente ayudan a mantener el filo de los cuchillos afilado durante más tiempo.
- Tabla de corte tratada con un revestimiento protector y anti-bacteriana.
- Cubeta extraíble para recoger los alimentos cortados.
- Cubeta apta para el horno (hasta 250°C) y el lavavajillas.
- Pies antideslizantes, garantiza la estabilidad de la tabla durante el corte.

- Planche à découper pratique avec un ou deux bac en acier inoxydable totalement extractibles.
- Les fibres placées verticalement aident à maintenir le fil de la lame des couteaux aiguisés plus longtemps.
- Planche à découper traitée avec un revêtement de protection et antibactérien.
- Bacs extractibles pour accueillir les aliments coupés.
- Bacs aptes pour le four (jusqu'à 250 °C) et le lave-vaisselle.
- Pieds antidérapants qui garantissent la stabilité de la planche à découper pendant la découpe.

- Handy cutting board with one or two completely removable stainless steel trays.
- The fibres are arranged vertically to help knife blades retain their sharpness for longer.
- Cutting board treated with a protective and anti-bacterial coating.
- Removable tray for collecting chopped food.
- Tray is oven-safe (up to 250°C) and dishwasher-safe.
- Non-slip feet ensure the board remains stable when cutting.

**Pies antideslizantes**  
Non-slip feet



**Bambú**  
Bamboo

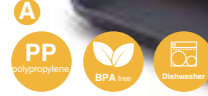

**Tabla de corte COLLET HOME**

Planche à découper · Schneidebrett  
Cutting board · Tábua de corte

Ref	€	Tabla (cm)	Cubeta (cm)	U.Venta
60594	29,80	35x29x4	-	1
A R60594A	4,80	-	34x26,5x2	1

**Base de cristal de Ø25 cm**  
Ø25 cm glass base



**Cristal**  
Glass

**Acacia**  
wood

**Set cuchillos para queso**

Jeu de couteaux pour le fromage · Set von Messern für Käse  
Knives set · Jogo de facas para queijo

Ref	€	Ø (cm)	h (cm)	U.Venta
60072	47,00	25	5	1

**Para cortar, presentar y conservar**  
To cut, present and preserve



**AS**  
plastic

**BPA free**

**Acacia**  
wood

**Quesera KEEP**

Plateau à fromage avec cloche · Käseglocke  
Cheese dome · Queijeira

Ref	€	cm	h Total (cm)	U.Venta
62004	25,30	28,5x18,5	10	1

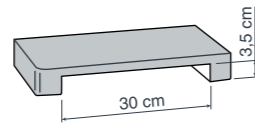

**Apertura por ambos lados**  
Opening on both sides

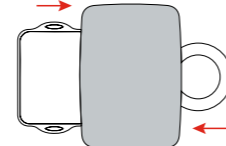

**Ideal para colocar platos o bandejas en ambos lados**  
Ideal for placing plates or trays on both sides



**Pies antideslizantes**  
Non-slip feet

**Bambú**  
Bamboo

**Tabla de corte COLLET**

Planche à découper · Schneidebrett  
Cutting board · Tábua de corte

Ref	€	cm	h (cm)	U.Venta
60595	30,30	40x26	5	1

- Fabricada en robusta madera de acacia.
- Superficie de corte en cristal con un Ø25 cm.
- Incluye 4 cuchillos fabricados en acero inoxidable con mango de madera.
- Ideal para cortar quesos y presentarlos sobre la misma.

- Fabriquée en bois d'acacia robuste.
- Surface de découpe en verre avec un Ø de 25 cm.
- Inclut 4 couteaux fabriqués en acier inoxydable avec manche en bois.
- Idéale pour couper le fromage et le présenter à table.

- Made of sturdy acacia wood.
- Ø25cm glass cutting surface.
- Includes 4 stainless steel knives with wooden handles.
- Ideal for cutting and serving cheese.



- Quesera compuesta por base de madera de acacia natural y tapa de plástico, libre de BPA.
- Práctica y funcional; corta, presenta y conserva los alimentos en las mejores condiciones.
- Tapa en forma de campana con pomo para facilitar su manipulación.

- Plateau à fromage composé d'un plateau en bois d'acacia naturel et d'une cloche en plastique, sans BPA.
- Pratique et fonctionnel ; coupez, présentez et conservez les aliments dans les meilleures conditions.
- Cloche avec pommeau pour faciliter sa prise en mai

- Cheese dome with a natural acacia wood base and a plastic cover. BPA free.
- Practical and functional. Cut, present and conserve food under the best conditions.
- The cover is bell shaped and has a handle so it's easy to use.



# TABLAS DE CORTE PP / PE

## Colección



**ES**

- Ideales para cortar todo tipo de alimentos.
- Perfectas para colocar sobre la encimera de la cocina.
- Ligeras y resistentes.
- Antibacterianas.
- Higiénicas y fáciles de limpiar.
- Aptas para el lavavajillas.

**FR**

- Idéales pour couper tout type d'aliments.
- Parfaites pour installer sur le plan de travail de la cuisine.
- Légères et résistantes.
- Antibactérien.
- Hygiéniques et faciles à nettoyer.
- Aptes pour le lave-vaisselle.

**EN**

- Ideal for cutting any type of food.
- Perfect for placing on kitchen counters.
- Lightweight and strong.
- Antibacterial.
- Hygienic and easy to clean.
- Dishwasher safe.

**Asa para facilitar su manejo**  
**Tope de silicona antideslizante**  
**Antibacteriana**  
Handle for easy handling  
Non-slip silicone stopper  
Antibacterial



**PP**  
polypropylene

**Set 3 tablas de corte GREY**

Set 3 planches à découper · Set 3 Schneiderbrett  
3 cutting boards set · Conjunto 3 tábuas de corte

Ref	€	cm	U.Venta
60500	13,20	20x15	1
		30x20	
		35x25	



**PP**  
polypropylene

**Set 3 tablas de corte OCEAN**

Set 3 planches à découper · Set 3 Schneiderbrett  
3 cutting boards set · Conjunto 3 tábuas de corte

Ref	€	cm	U.Venta
60555	13,20	20x15	1
		30x20	
		35x25	



**PP**  
polypropylene

**Tabla de corte**

Planche à découper · Schneidebrett  
Cutting board · Tábua de corte

Ref	€	cm	h (cm)	U.Venta
60501	8,10	30x18	1	1
60502	11,10	36x22	1	1
60503	14,90	42x25,5	1	1





Tacos antideslizantes  
Non slip plugs



**Tabla de corte polietileno**  
Planche à découper en polyéthylène · Schneidebrett Polyethylen  
Polyethilene cutting board · Tábua de corte polietileno

GN 1/4 - 265x162 mm				GN 1/2 - 325x265 mm				GN 1/1 - 530x325 mm				600x400 mm			
Ref	€	h (mm)	U.Venta	Ref	€	h (mm)	U.Venta	Ref	€	h (mm)	U.Venta	Ref	€	h (mm)	U.Venta
60569	10,80	20	6	60455	21,10	20	6	60456	41,80	20	1	60457	58,90	20	1
				60405	31,00	30	6	60406	62,30	30	1	60407	87,20	30	1
								60575	120,90	50	1				



Tacos antideslizantes  
Non slip plugs



- Pescado · Fish** ■
- Verduras+frutas · Vegetables+Fruits** ■
- Embutidos · Cold cred meat** ■
- Carne · Meat** ■
- Aves · Poultry** ■
- Varios · Various** ■

**Tabla de corte**  
Planche à découper · Schneidebrett  
Cutting board · Tábua de corte

GN 1/4 - 265x162 mm				GN 1/2 - 325x265 mm				GN 1/1 - 530x325 mm				600x400 mm			
Ref	€	h (mm)	U.Venta	Ref	€	h (mm)	U.Venta	Ref	€	h (mm)	U.Venta	Ref	€	h (mm)	U.Venta
60570	10,80	20	1	60470	21,10	20	1	60475	41,60	20	1	60600	59,20	20	1
60571	10,80	20	1	60471	21,10	20	1	60476	41,60	20	1	60601	59,20	20	1
60572	10,80	20	1	60472	21,10	20	1	60477	41,60	20	1	60602	59,20	20	1
60573	10,80	20	1	60473	21,10	20	1	60478	41,60	20	1	60603	59,20	20	1
								60576	117,80	50	1				
60574	10,80	20	1	60474	21,10	20	1	60479	41,60	20	1	60604	59,20	20	1
60577	10,80	20	1	60480	21,10	20	1	60481	41,60	20	1	60605	59,20	20	1

**PE-500 (HD-HMW) High Molecular AA Weight Polyethylene**

Especial para preparar comidas que no contengan alérgenos  
Identifiquela rápidamente por su intenso color morado  
Specially made for making food that contains no allergens  
Identify it quickly by its deep purple colouring



**Tabla de corte antialérgica**  
Planche à découper · Schneidebrett  
Anti-allergy cutting board · Tábua de corte

GN 1/2 - 325x265 mm				GN 1/1 - 530x325 mm				600x400 mm			
Ref	€	h (mm)	U.Venta	Ref	€	h (mm)	U.Venta	Ref	€	h (mm)	U.Venta
60521	24,00	20	1	60522	48,00	20	1	60606	58,70	20	1

**PE-500 (HD-HMW) High Molecular AA Weight Polyethylene**

**Robusta y alta durabilidad  
Antibacteriana**  
Robust and high durability  
Antibacterial



**Tabla de corte COLLECT GN 2/3**  
Planche à découper · Schneidebrett  
Cutting board · Tábua de corte

Ref	€	Tabla (cm)	Cubeta (cm)	Cubeta (L)	U.Venta
60593	99,40	41x34x6,5	-	-	1
*66540Z	21,70	-	35,4x32,5x4	3,5	1

\* Apta cubeta Inox 18/10 (66540) · Suitable for 18/10 stainless steel tray (66540)



**Cepillo para tablas de corte**  
Brosse pour planche à découper · Brush für Schneidebrett  
Brush cutting board · Cepilho para tábua de corte

Ref	€	cm	h (cm)	U.Venta
60458	66,30	17x6	10	1

- Práctica tabla de corte con una cubeta GN 2/3 de acero inoxidable oculta completamente extraíble.
- Fabricada en polietileno de alta densidad de color blanco.
- Segura, ligera e higiénica, no absorbe humedad y evita la proliferación de bacterias.
- Gracias a su superficie suave, protege las hojas de los cuchillos.
- Cubeta extraíble (35,4x32,5x4 cm) para recoger los alimentos cortados.
- Cubeta apta para el horno (hasta 250°C) y el lavavajillas.
- Pies antideslizantes, garantiza la estabilidad de la tabla durante el corte.
- Resistente a los cortes y los arañazos.

- Planche à découper pratique avec un bac GN 2/3 en acier inoxydable totalement extractibles.
- Fabriquée en polyéthylène de haute densité de couleur blanche.
- Sûre, légère et hygiénique, elle n'absorbe pas l'humidité et évite la prolifération des bactéries.
- Grâce à sa surface douce, elle protège les lames des couteaux.
- Bacs extractibles (35,4x32,5x4 cm) pour accueillir les aliments coupés.
- Bacs aptes pour le four (jusqu'à 250 °C) et le lave-vaisselle.
- Pieds antidérapants qui garantissent la stabilité de la planche à découper pendant la découpe.
- Résistante aux coupures et aux rayures.

- Handy cutting board with one completely removable stainless steel GN 2/3 tray.
- Made of white high-density polyethylene.
- Safe, light and hygienic, it does not absorb moisture and prevents the growth of bacteria.
- It protects knife blades thanks to its smooth surface.
- Removable tray (35,4x32,5x4 cm) for collecting chopped food.
- Tray is oven-safe (up to 250°C) and dishwasher-safe.
- Non-slip feet ensure the board remains stable when cutting.
- Resistant to cuts and scratches.

- Para uso de tablas de polietileno profesionales.
- Renueva las tablas, eliminando las rayas o pequeñas grietas.
- Crea una superficie limpia y totalmente lisa.
- Asa ergonómica que permite moverlo con facilidad sobre toda la superficie de la tabla.

- A utiliser sur les panneaux professionnels en polyéthylène.
- Remet à neuf les panneaux en éliminant les rayures ou les petites fissures.
- Crée une surface propre et parfaitement lisse.
- Poignée ergonomique pour un déplacement aisé sur toute la surface de la planche.

- For use on professional polyethylene boards.
- Refurbishes boards, eliminating scratches or small cracks.
- Creates a clean and completely smooth surface.
- Ergonomic handle for easy movement over the entire surface of the board. surface of the board.

**New**



**Soporte tablas de corte**  
Support pour planches à découper · Schneidebretthalter  
Cutting board rack · Suporte para tábuas de cortar

Ref	€	cm	h (cm)	U.Venta
60579	27,90	34x30	27,8	1

**Inox**

**Multifuncional: apto para tablas, bandejas, moldes rígidos, etc.**  
Multifunctional: suitable for boards, trays, rigid moulds, etc

- Fabricado en varilla de acero inoxidable de gran calidad.
- Diseñado para organizar hasta 6 tablas de corte de 3 cm de espesor.
- Multifuncional: apto para tablas, bandejas, moldes rígidos, etc.
- 4 patas antideslizantes para garantizar una máxima estabilidad.

















- Fabriqué en acier inoxydable de grande qualité.
- Conçu pour ranger jusqu'à 6 planches à découper de 3 cm d'épaisseur.
- Multifonctions : apte pour des planches à découper, des plateaux, des moules rigides, etc.
- 4 pieds antidérapants pour garantir une stabilité maximale

- Made of high quality stainless steel rods.
- Designed to hold up to six 3 cm-thick cutting boards.
- Multifunctional: suitable for boards, trays, rigid moulds, etc.
- 4 non-slip feet for maximum stability.

# CUBIERTOS

## Colección



-  **Cuchara mesa** · Table spoon
-  **Tenedor mesa** · Table fork
-  **Cuchillo mesa** · Table knife
-  **Cuchara postre** · Dessert spoon
-  **Tenedor postre** · Dessert fork
-  **Cuchillo postre** · Dessert knife
-  **Cuchara café** · Coffee spoon
-  **Cuchara moka** · Moka spoon
-  **Tenedor lunch** · Lunch fork
-  **Tenedor pescado** · Fish fork
-  **Pala pescado** · Fish knife
-  **Cazo sopa** · Soup ladle
-  **Cuchara servir** · Serving spoon
-  **Tenedor servir** · Serving fork
-  **Cacillo salsa** · Gravy shovel
-  **Pala pastel** · Cake shovel



Inox

Espesor · Thickness: 1,8 mm

## HOTEL

Ref	€	U.Venta	
33101	1,70	12	Cuchara mesa · Table spoon
33102	1,70	12	Tenedor mesa · Table fork
33103	2,80	12	Cuchillo mesa · Table knife
33104	1,40	12	Cuchara postre · Dessert spoon
33105	1,40	12	Tenedor postre · Dessert fork
33106	2,70	12	Cuchillo postre · Dessert knife
33107	1,10	12	Cuchara café · Coffee spoon
33108	0,90	12	Cuchara moka · Moka spoon
33109	1,10	12	Tenedor Lunch · Lunch fork

## ARIES

Ref	€	U.Venta	
33401	2,70	12	Cuchara mesa · Table spoon
33402	2,70	12	Tenedor mesa · Table fork
33403	6,00	12	Cuchillo mesa · Table knife
33404	2,70	12	Cuchara postre · Dessert spoon
33405	2,70	12	Tenedor postre · Dessert fork
33406	6,00	12	Cuchillo postre · Dessert knife
33407	1,40	12	Cuchara café · Coffee spoon
33408	1,30	12	Cuchara moka · Moka spoon
33409	1,70	12	Tenedor Lunch · Lunch fork
33410	2,70	12	Tenedor pescado · Fish fork
33411	2,70	12	Pala pescado · Fish knife
33412	10,60	1	Cazo sopa · Soup ladle
33413	6,50	1	Cuchara servir · Serving spoon
33414	6,60	1	Tenedor servir · Serving fork
33415	8,40	1	Cacillo salsa · Gravy shovel
33416	7,20	1	Pala pastel · Cake shovel



Inox 18/10

Espesor · Thickness: 2,5 mm



Dishwasher

# CUBERTEROS

## Colección



**Soporte cubiertos con vasos**  
Porte couverts avec paniers · Besteckbehälter  
Cutlery holder w/cylinder · Sup. talheres com copos

Ref.	€	cm	Orif.	U.Venta
33124	84,70	29x22x26	4	1
33126	104,10	29x22x38	6	1



**Vasos inox cubertería**  
Panier pour porte couvert · Besteckköcher  
St. steel cutlery cylinder · Copos p/talheres inóx

Ref.	€	h (cm)	U.Venta
33125	7,60	14	6



**Contenedor cubiertos**  
Panier à couverts · Besteckköcher  
Cutlery holder · Copos para talheres

Ref	€	Ø (cm)	h (cm)	L	U.Venta
62962	21,00	12	13,6	1,40	1
62963	24,40	12	18,7	2,00	1

Inox

**4 compartimentos**  
4 compartments  
Hueco · Hollow: 11x25x9 cm



**Cubertero GN 1/1**  
Range-couverts · Besteckkasten  
Cutlery holder · Bandeja para talheres

Ref	€	cm	h (cm)	U.Venta
33121	11,20	52,5x32	9,5	1

- Recipiente para cubiertos en color negro de polipropileno.
- Ideal para organizar y guardar los cubiertos e utensilios de la cocina.
- No se deforma con el peso de los cubiertos.
- Cómodo de transportar gracias a sus asas laterales.
- Fondo redondeado para un fácil mantenimiento.
- Apilable.

- Pot à couverts en polypropylène noir.
- Idéal pour organiser et ranger les couverts et les ustensiles de cuisine.
- Il ne se déforme pas avec le poids des couverts.
- Confortable à transporter grâce à ses poignées latérales.
- Fond arrondi pour un entretien facile.
- Empilable.

- Black polypropylene cutlery container.
- Ideal for organizing and storing cutlery and kitchen utensils.
- It does not deform with the weight of the cutlery.
- Comfortable to transport thanks to its side handles.
- Rounded bottom for easy maintenance.
- Stackable.

A



**Trenzados**  
Braided

B



C



**Bastidor cromado reforzado**  
Reinforced chrome frame

**4 compartimentos**  
4 compartments

**Cubertero RATTAN PP**  
Range-couverts · Besteckkasten  
Cutlery holder · Bandeja para talheres

Ref	€	cm	h (cm)	Compart.	U.Venta
A 63484	8,40	27x10	4,5	1	1
B 63485	8,40	Ø12	15,0	1	1
C 63491	74,80	53x32,5	9,0	4	1

# 05

**Buffet**  
Buffet



# CHAFING DISH

## Colección

Inox 18/10

Vitro Electric Gas Induction



ES

- Tapa con descenso amortiguado para un cierre suave.
- Tapa extraíble verticalmente para su limpieza.
- Visor de cristal.
- Las gotas de condensación retornan a la cubeta.
- Salsera lateral para la sujeción de cacillos o espumaderas.
- Disponibilidad de aro complementario para el empleo de placa de inducción.

FR

- Couvercle avec descente amortie pour une fermeture en douceur.
- Couvercle peut s'extraire verticalement pour un nettoyage aisé.
- Écran en verre.
- Les gouttelettes de condensation retombent dans la cuvette.
- Saucière latérale pour la fixation de louches ou d'écumoirs.
- Disponibilité d'anneaux complémentaires pour l'utilisation de plaques à induction.

EN

- Cover with damping seal for smooth closure.
- Cover can be removed vertically for easy cleaning.
- Glass display.
- The condensation droplets return to the receptacle.
- Lateral sauceboat for holding scoops and skimmers.
- Availability of additional rings for the use of induction hobs.



### Chafing dish GN 1/1 LUXE

Bain marie GN 1/1 · Chafing Dish, GN-Einsatz 1/1  
GN 1/1 chafing dish · Chafing dish GN 1/1

Ref	€	cm	h (cm)	L	U.Venta
69091	1.010,60	47x59,5	43,0	9,0	1



### Cuerpo chafing dish GN 1/1 LUXE

Corps bain marie GN 1/1 · Chafing Dish Körper, GN-Einsatz 1/1  
GN 1/1 chafing dish body · Corpo chafing dish GN 1/1

Ref	€	cm	h (cm)	L	U.Venta
69099	813,10	59,5x47	25,0	9,0	1

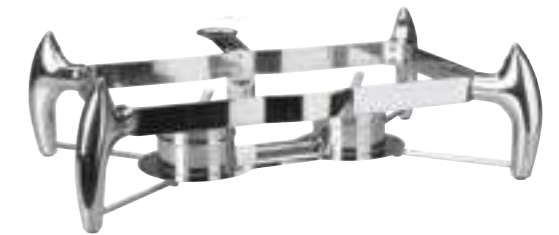

### Soporte chafing dish GN 1/1 LUXE

Support Bain marie GN 1/1 · Gestell für Chafing Dish 1/1  
GN 1/1 chafing dish stand · Suporte chafing dish GN 1/1

Ref	€	cm	h (cm)	U.Venta
69089	197,40	41x55	17,0	1

Placa encastrable.  
Necesita agujero de Ø216 mm para introducirla  
Encastable plate.  
Need a Ø216 mm hole to insert the plate



### Placa inducción con regulador

Plaque à induction a/regulateur · Induktionskochfeld m/ regler  
Round induction plate with power control · Placa de indução com regulador

Ref	€	W	cm	U.Venta
69131	113,90	1000	Ø24x8	1



### Aro complemento chafing dish

Support plaque induction · Zusatzring chafing-dish  
Chafing-dish heater holder · Aro complemento chafing dish

Ref	€	Ø (cm)	U.Venta
R69099B	18,70	26	1



### Salsera chafing dish

Saucière chafing-dish · Saucière Chafing Dish  
Gravy spoon holder · Molheira chafing dish

Ref	€	cm	h (cm)	L	U.Venta
R69099C	15,90	12x23	4,0	0,40	1



### Chafing dish GN 2/3 LUXE

Bain marie GN 2/3 · Chafing Dish, GN-Einsatz 2/3  
GN 2/3 chafing dish · Chafing dish GN 2/3

Ref	€	cm	h (cm)	L	U.Venta
69092	804,70	43x46	58,5	5,5	1



### Cuerpo chafing dish GN 2/3 LUXE

Corps bain marie GN 2/3 · Chafing Dish Körper, GN-Einsatz 2/3  
GN 2/3 chafing dish body · Corpo chafing dish GN 2/3

Ref	€	cm	h (cm)	L	U.Venta
69095	635,60	46x43	25,5	5,5	1



### Soporte chafing dish LUXE GN 2/3

Support Bain marie GN 2/3 · Gestell für Chafing Dish 2/3  
GN 2/3 chafing dish stand · Suporte chafing dish GN 2/3

Ref	€	cm	h (cm)	U.Venta
69087	169,10	40x37	17,0	1



### Chafing dish GN 1/2 LUXE

Bain marie GN 1/2 · Chafing Dish, GN-Einsatz 1/2  
GN 1/2 chafing dish · Chafing dish GN 1/2 steel

Ref	€	cm	h (cm)	L	U.Venta
69093	725,20	32,5x46	44,5	4,0	1



### Cuerpo chafing dish LUXE GN 1/2

Corps bain marie GN 1/2 · Chafing Dish Körper, GN-Einsatz 1/2  
GN 1/2 chafing dish body · Corpo chafing dish GN 1/2

Ref	€	cm	h (cm)	L	U.Venta
69094	585,60	46x32,5	25,5	4,0	1



### Soporte chafing dish GN 1/2 LUXE

Support Bain marie GN 1/2 · Gestell für Chafing Dish 1/2  
GN 1/2 chafing dish stand · Suporte chafing dish GN 1/2

Ref	€	cm	h (cm)	U.Venta
69088	139,50	40x28	17,0	1

**Placa encastrable.**  
Necesita agujero de Ø216 mm para introducirla  
Encastable plate.  
Need a Ø216 mm hole to insert the plate



### Aro complemento chafing dish

Support plaque induction · Zusatzring chafing-dish  
Chafing-dish heater holder · Aro complemento chafing dish

Ref	€	Ø (cm)	U.Venta
R69099B	18,70	26	1



### Placa inducción con regulador

Plaque à induction a/regulateur · Induktionskochfeld m/ regler  
Round induction plate with power control · Placa de indução com regulador

Ref	€	W	cm	U.Venta
69131	113,90	1000	Ø24x8	1



### Salsera chafing dish

Saucière chafing-dish · Sauciere Chafing Dish  
Gravy spoon holder · Molheira chafing dish

Ref	€	cm	h (cm)	L	U.Venta
R69099C	15,90	12x23	4,0	0,40	1

**Placa encastrable.**  
Necesita agujero de Ø216 mm para introducirla  
Encastable plate.  
Need a Ø216 mm hole to insert the plate



### Aro complemento chafing dish

Support plaque induction · Zusatzring chafing-dish  
Chafing-dish heater holder · Aro complemento chafing dish

Ref	€	Ø (cm)	U.Venta
R69094A	18,90	18	1



### Placa inducción con regulador

Plaque à induction a/regulateur · Induktionskochfeld m/ regler  
Round induction plate with power control · Placa de indução com regulador

Ref	€	W	cm	U.Venta
69139	113,20	700	Ø18x8	1



### Salsera chafing dish

Saucière chafing-dish · Sauciere Chafing Dish  
Gravy spoon holder · Molheira chafing dish

Ref	€	cm	h (cm)	L	U.Venta
R69099C	15,90	12x23	4,0	0,40	1



### Chafing dish SOPA LUXE

Bain marie soupriere · Suppen Chafing Dish  
Soup chafing dish · Chafing dish sopa

Ref	€	Ø (cm)	h (cm)	L	U.Venta
69098	640,90	45	57,0	11,0	1



### Chafing dish REDONDO LUXE

Bain marie ronde · Chafing Dish, rund  
Round chafing dish · Chafing dish redondo

Ref	€	cm	h (cm)	L	U.Venta
69101	796,40	46,5x53	45,0	6,0	1



### Cuerpo chafing dish SOPA LUXE

Corps bain marie soupriere · Suppen Chafing Dish Körpe  
Soup chafing dish body · Corpo chafing dish sopa

Ref	€	Ø (cm)	h (cm)	L	U.Venta
69100	471,00	45	38,0	11,0	1



### Soporte chafing dish SOPA LUXE

Support bain marie soupriere · Gestell für Suppen Chafing Dish  
Soup chafing dish stand · Suporte chafing dish sopa

Ref	€	cm	h (cm)	U.Venta
69097	170,00	41x32	17,0	1



### Cuerpo chafing dish REDONDO LUXE

Corps bain marie ronde · Chafing Dish Körpe, rund  
Round chafing dish body · Corpo chafing dish redondo

Ref	€	cm	h (cm)	L	U.Venta
69096	626,50	46,5x53	25,0	6,0	1



### Soporte chafing dish SOPA LUXE

Support bain marie soupriere · Gestell für Suppen Chafing Dish  
Soup chafing dish stand · Suporte chafing dish sopa

Ref	€	cm	h (cm)	U.Venta
69097	170,00	41x32	17,0	1

**Placa encastrable. Necesita agujero de Ø216 mm para introducirla**  
Encastable plate. Need a Ø216 mm hole to insert the plate



### Placa inducción con regulador

Plaque à induction a/regulateur · Induktionskochfeld m/ regler  
Round induction plate with power control · Placa de indução com regulador

Ref	€	W	cm	U.Venta
69131	113,90	1000	Ø24x8	1



### Salsera chafing dish

Saucière chafing-dish · Sauciere Chafing Dish  
Gravy spoon holder · Molheira chafing dish

Ref	€	cm	h (cm)	L	U.Venta
R69099C	15,90	12x23	4,0	0,40	1



### Aro complemento chafing dish

Support plaque induction · Zusatzring chafing-dish  
Chafing-dish heater holder · Aro complemento chafing dish

Ref	€	Ø (cm)	U.Venta
R69100B	19,30	27	1



### Contenedor chafing dish LUXE SOPA

Soupiere Bain marie · Suppenbehälter chafing Dish  
Soup container chafing dish · Recipiente chafing dish sopa

Ref	€	Ø (cm)	h (cm)	L	U.Venta
R69100A	25,10	29	22,0	11,0	1

**Placa encastrable. Necesita agujero de Ø216 mm para introducirla**  
Encastable plate. Need a Ø216 mm hole to insert the plate



### Placa inducción con regulador

Plaque à induction a/regulateur · Induktionskochfeld m/ regler  
Round induction plate with power control · Placa de indução com regulador

Ref	€	W	cm	U.Venta
69131	113,90	1000	Ø24x8	1



### Salsera chafing dish

Saucière chafing-dish · Sauciere Chafing Dish  
Gravy spoon holder · Molheira chafing dish

Ref	€	cm	h (cm)	L	U.Venta
R69099C	15,90	12x23	4,0	0,40	1



### Aro complemento chafing dish

Support plaque induction · Zusatzring chafing-dish  
Chafing-dish heater holder · Aro complemento chafing dish

Ref	€	Ø (cm)	U.Venta
R69100B	19,30	27	1



### Fuente para chafing dish redondo

Plat rond pour Bain marie ronde · Einsatz für chafing-dish, rund  
Food pan for round chafing-dish · Travessa para chafing dish redondo

Ref	€	Ø (cm)	U.Venta
69019	59,30	35x7	1



### Chafing dish GN 1/1 roll top LATÓN

Bain marie GN 1/1 roll top · Chafing Dish, mit GN-Einsatz, Rolldeckel  
Chafing dish GN 1/1 roll top · Chafing dish GN 1/1 roll top

Ref	€	cm	h (cm)	L	U.Venta
69015	754,30	53x32,5	6,50	9,0	1



### Chafing dish GN 1/1 roll top INOX

Bain marie GN 1/1 roll top · Chafing Dish, mit GN-Einsatz, Rolldeckel  
Chafing dish GN 1/1 roll top · Chafing dish GN 1/1 roll top

Ref	€	cm	h (cm)	L	U.Venta
69034	676,80	53x32,5	6,50	9,0	1



### Chafing dish GN1/1 con tapa CLASSIC

Bain marie GN 1/1 avec couvercle · Chafing Dish, mitGN-Einsatz 1/1 mit Deckel  
Chafing Dish GN 1/1 with lid · Chafing Dish GN 1/1 com tampa

Ref	€	cm	h (cm)	L	U.Venta
69110	107,10	56x35	28,0	8,5	1

**Gel de origen orgánico**  
No produce emanaciones tóxicas  
Encendido rápido y combustión silenciosa, limpia, inodora, sin humos y sin cenizas.  
Organic gel fuel  
Does not produce toxic fumes  
Quick-lighting and quiet-burning, clean, odourless, smokeless and ash-free

Inox



### Contenedor de combustible

Porte-brûleur · Brennpasten-Behälter  
Burner holder · Recipiente de combustible

Ref	€	Ø (cm)	h (cm)	L (cm) Asa	U.Venta
69006	23,90	9,0	6,0	7,0	1

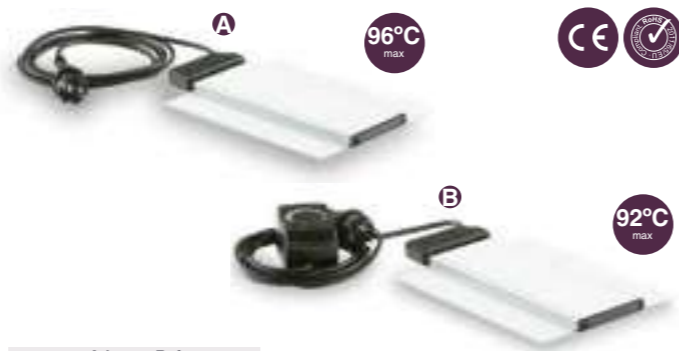

Adapt. a Ref

69015 - 69001 - 69004 - 69110

### Calentador eléctrico para chafing

Corp de chauffe pour bain marie · Elektro-Heizung für Chafing Dish  
Electric heating unit for chafing dish · Aquecedor eléctrico para chafing dish

Ref	€	W	U.Venta
A 69002	185,60	700	1
B 69012	214,70	700	1

Con regulador · With regulator



### Gel combustible ETANOL

Gel chauffe ETHANOL · Brennpaste, ETHYALKOHOL  
Fuel gel, ETHANOL · Gel combustible ETANOL

Ref	€	Kg	Horas	U.Venta
A 71780	4,80	0,08	80 min	1
B 69108	2,70	0,225	3	72
C 69107	8,60	0,840	-	1
D 69109	39,40	4,00	-	1

Combinaciones posibles de cubetas · Possible tray options



### Chafing dish eléctrico

Chafing dish électrique · Elektrische Chafing Dish  
Electric Chafing dish · Chafing dish eléctrico

Ref	€	W	U.Venta
69336	178,10	900	1

Ref	Tensión/Voltage	Potencia/Power	Capacidad/Capacity	Temperatura/Temp.	Cubeta/Container	Dimensiones/Sizes	Peso/Weight
69336	220-240 V / 50-60 Hz	900 W	8,50 L	85°C (+/-10°C)	1GN 1/1 h=65 mm	55x34,5x25 cm	3,90 Kg



### Servidor de zumos cromado

Distributeur de jus en inox · Saftbehälter mit rostfreiem Fuss  
Juice dispenser mirror stand · Distribuidor de zumos pé cromado

Ref	€	L	U.Venta
69027	331,80	8,70	1
A R69018	28,80	-	1
B R69027	94,90	8,70	1

Grifo · Tap  
Contenedor · Container



- Ideal para el sector de la hostelería, restauración y catering.
- Mantiene la temperatura de los alimentos.
- Más seguro al carecer de llama de los geles.
- Tapa y cubeta extraíble GN 1/1 h=65 mm (8,50 L) fabricados en acero inoxidable de alta calidad. Cuerpo fabricado en polipropileno.
- Termostato regulable (85°C +/-10°C).
- Interruptor de encendido y apagado. Indicador luminoso.
- Protección contra sobrecalentamiento.
- Fácil de transportar gracias a sus asas laterales.
- 6 pies antideslizantes y resistentes para mantener la estabilidad.

- Parfait pour le secteur hôtelier, la restauration et le traiteur.
- Conserve la température des aliments.
- Plus sûr parce qu'il n'y a pas de flamme des gels.
- Couvercle et bac amovible GN 1/1 h=65 mm (8,50 L) en acier inoxydable de haute qualité. Corps fabriqué en polypropylène.
- Thermostat réglable (85°C +/- 10°C).
- Interrupteur marche/arrêt. Indicateur lumineux.
- Protection contre les surchauffes.
- Facile à transporter grâce à ses poignées latérales.
- 6 pieds antidérapants et résistants pour maintenir la stabilité

- Ideal for the hospitality, restaurant and catering sectors.
- Maintains temperature of food.
- Safer than chafing dishes that use gel fuels.
- Removable lid and tray GN 1/1 h=65 mm (8.5 L) manufactured in high-quality stainless steel. Body manufactured in polypropylene.
- Adjustable thermostat (85°C +/-10°C).
- On / Off switch. Light indicator.
- Overheating protection.
- Easily portable using the side handles.
- 6 non-slip resistant bases to ensure stability.



### Calentador de líquidos BUFFET

Chauffe-café · Getränkebehälter  
Coffee urn · Aquecedor de líquidos

Ref	€	L	U.Venta
69028	372,70	11,0	1
A R69018	28,80	-	1

Grifo · Tap

# AIRPOT

## Colección

**Boca ancha para cubitos hielo**  
Wide mouth for ice cubes



**Doble pared**  
Double wall

### Air pot

Air pot · Getränkespender, isoliert  
Air pot · Air pot

Ref	€	L	h (cm)	U.Venta
62472	69,60	2,50	32,5	1
62473	75,50	3,00	34,5	1
62475	101,20	4,00	39,0	1

Inox

### NO UTILIZAR CON BEBIDAS GASEOSAS, CALDOS NI LÁCTEOS

DO NOT USE WITH FIZZY DRINKS, BROTHS OR DAIRY



- Mantiene las bebidas calientes o frías durante 24 horas.
- Doble pared que proporciona un alto rendimiento térmico.
- Ligero e irrompible.
- Boca ancha para cubos de hielo.
- Fácil de abrir y cerrar. Fácil limpieza.
- Maintient les boissons chaudes ou froides pendant 24 heures.
- Double paroi qui confère un haut rendement thermique.
- Léger et incassable.
- Bec large pour glaçons.
- Ouverture et fermeture faciles. Facile a nettoyer.
- Keeps drinks hot or cold for 24 hours.
- Double wall that provides high thermal performance.
- Light and shatterproof.
- Wide mouth for ice cubes.
- Easy to open and close. Facile a nettoyer.

# PERCOLADORA

## Cafetera

Inox CE

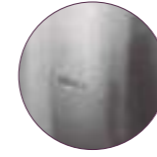

**Fácil apertura**  
**Marcas de llenado**  
**Filtro microperforado**  
Easy open system  
Fill lines  
Micro-perforated filter



### Cafetera percoladora

Percolateur à café · Kaffee-Perkolator  
Coffee percolator · Máquina/Percolador de café

Ref	€	W	L	U.Venta
69486	162,90	1500	6	1
69481	181,70	1500	10	1

- Fabricada en acero inoxidable de gran calidad.
- Ideal para cafeterías, restaurantes, bares, servicios de buffet y estaciones self-service.
- 2 sistemas de calentamiento independientes para la función de infusión y la función de conservación del calor.
- Distribución de calor rápida y homogénea.
- Mantiene el café a la temperatura óptima salvaguardando sus propiedades de sabor y aroma durante horas.
- Filtro de malla microperforada de acero inoxidable, especialmente diseñado para evitar la generación de posos.
- Luz indicadora de preparación. Indicador del nivel de agua. Bandeja antigoteo.
- Tapa con cierre de seguridad mediante botón de bloqueo.
- Sistema de protección contra el calentamiento en vacío.
- Opción de flujo continuo para una máxima comodidad.
- Tapa, filtro y tubo percolador aptos para el lavavajillas.

- Made of high quality stainless steel.
- Perfect for cafés, restaurants, bars, buffet services and self-serve stations.
- Two independent heating systems for the infusion function and the heat preservation system.
- Fast and even heat distribution.
- Keeps coffee at the perfect temperature so it can retain its flavour and aroma for many hours.
- Stainless steel micro-perforated filter specially designed to prevent build-up.
- In-use indicator light. Water level indicator. Anti-drip tray.
- Lid with lock button activated safety lock.
- System to protect against heating while empty.
- Continuous flow option for maximum convenience.
- The lid, filter and percolator tube are dishwasher safe.

Ref	Tensión/Voltage	Potencia/Power	Volumen/Volume	Capacidad/Capacity	Dimensiones/Sizes	Peso/Weight
69486	220-240 V; 50 Hz	1500 W	6 L	4,8 L (max)	28x28x40 cm	2,20 Kg
69481	220-240 V; 50 Hz	1500 W	10 L	8,2 L (max)	35x35x45 cm	2,80 Kg

# CAFÉ

## Organizador

ASA Acrylic Dishwasher



### Organizador de café

Organisateur de café · Kaffee Veranstalter  
Coffee organizer · Organizador de café

Ref	€	cm	h (cm)	U.Venta
A 62280	10,40	11,5x11,5	20	1
B 62281	37,90	35,5x26,5	18	1
C 62283	69,10	35,5x26,5	31	1



Inox CE

### NO UTILIZAR CON BEBIDAS GASEOSAS, CALDOS NI LÁCTEOS

DO NOT USE WITH FIZZY DRINKS, BROTHS OR DAIRY

- Dispensador con capacidades de 4, 6 y 10 litros.
- Fabricado en acero inoxidable resistente y de alta calidad.
- Dispone de un grifo dispensador con indicador de nivel de líquido.
- Temperatura controlada por termostato con un rango de 60°C a 100°C.
- Dispone de asas laterales aislantes del calor para un desplazamiento seguro.
- Ideal para agua, café y té.

- Distributeur d'une capacité de 4, 6 litres et de 10 litres.
- Fabriqué en acier inoxydable résistant et de grande qualité.
- Dispose d'un robinet de distribution avec indicateur du niveau de liquide.
- Température contrôlée par thermostat dans une tranche de 60°C à 100°C.
- Dispose de poignées latérales isolantes de la chaleur pour un déplacement sûr.
- Idéal pour l'eau, le café et le thé.

- 4, 6 and 10 litre capacity beverage dispensers.
- Made of strong high quality stainless steel.
- Includes a spigot with a level indicator.
- Temperature controlled by a thermostat with a range from 60°C to 100°C.
- Side mounted insulated handles for safe moving.
- Perfect for water, coffee and tea.

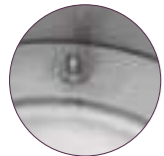

**Fácil apertura**  
**Marcas de llenado**  
**Sensor de temperatura**  
Easy open system  
Fill lines  
Temperature sensor



### Airpot eléctrico

Électrique Airpot · Elektrische Getränkespender  
Electric Airpot · Airpot eléctrico

Ref	€	L	U.Venta
69472	131,00	4	1
69476	141,60	6	1
69471	154,60	10	1

Ref	Tensión/Voltage	Potencia/Power	Capacidad/Capacity	Temperatura/Temp.	Dimensiones/Sizes	Peso/Weight
69472	220-240 V / 50-60 Hz	1500 W	4 L	60°C - 100°C	28x28x35 cm	1,90 Kg
69476	220-240 V / 50-60 Hz	1500 W	6 L	60°C - 100°C	28x28x40 cm	2,00 Kg
69471	220-240 V / 50-60 Hz	1500 W	10 L	60°C - 100°C	28x28x48 cm	2,20 Kg



# DISPENSADORES CEREALES

## Colección

ABS plastic Tapa/Lid  
PS Polystyrene Container  
TPR Ruleta Roulette  
dishwasher safe  
BPA free



**Conserva la frescura y el sabor de los alimentos por más tiempo**  
Preserves the freshness and taste of food for longer



ES

- Ideal para diversos tipos de alimentos como cereales, copos de avena, copos de maíz, pasta, café, frutos secos, etc.
- Higiénico y con gran capacidad de almacenamiento.
- Montaje en la pared, aprovecha el espacio de tu mostrador o encimera (62541-62542).

FR

- Idéal pour différents types d'aliments tels que les céréales, les flocons d'avoine, les copeaux de maïs, les pâtes, le café, les fruits secs, etc.
- Hygénique et offrant une grande capacité.
- Montage sur le mur, gain d'espace sur le comptoir ou le plan de travail (62541-62542).

EN

- Ideal for various types of foods such as cereals, oatmeal, cornflakes, pasta, coffee, nuts, etc.
- Hygienic and with a large storage capacity.
- Wall mounted so you can make the most of your countertop or worktop space (62541-62542).



**Sistema dispensador giratorio**  
Rotating dispensing system

**Base ancha; ofrece una mayor estabilidad**  
Wide base for greater stability

### Dispensador de cereales

Distributeur de céréales · Cerealienspender  
Cereal dispenser · Dispensador de cereais

Ref	€	cm	h (cm)	L	U.Venta
62545	24,00	16x20	40	3,50	1



**Tapa hermética**  
Lid hermetic

**Sistema dispensador giratorio**  
Rotating dispensing system

**Base ancha; ofrece una mayor estabilidad**  
Wide base for greater stability

### Dispensador de cereales DUAL

Distributeur de céréales · Frühstücksflocken Spender  
Cereal dispenser · Dispensador de cereais

Ref	€	L	U.Venta
62596	28,90	2 x 2	1
62597	37,20	3,5 x 2	1



**Tapa hermética**  
Lid hermetic

**Anclaje en pared**  
Wall anchor

**Sistema dispensador giratorio**  
Rotating dispensing system

### Dispensador de cereales de pared

Distributeur de céréales mural · Wandspender für Cerealien  
Wall-mounted cereal dispenser · Dispensador de cereais de parede

Ref	€	cm	h (cm)	L	U.Venta	
62541	16,40	14,5x12,5	31	1,50	1	Simple · Simple
62542	27,30	28x12,5	31	1,50 x 2	1	Doble · Double



Inox 18/10

Inox 18/10

**Permite su uso tanto para calentamiento como para refrigeración**  
Allows its use for both heating and cooling

**Grifo dispensador**  
Dispensing tap



### Dispensador de leche

Dispensateur de lait · Milchkanne mit Fuß  
Milk dispenser with base · Distribuidor de leite

Ref	€	cm	L	U.Venta
69030	412,30	22x33x44	5,5	1

### Dispensador de cereales con base

Distributeur de Cereales sur Pied · Cerialenspender mit Fuss  
Cereal Dispenser with Stand · Distribuidor de cereais com base

Ref	€	Ø (cm)	cm	L	U.Venta
A 69022	294,30	18,5	24x34x70	10,0	1
B 69023	582,80	18,5	44x34x70	10,0	1

# BUFFET

## Cacerolas



ES

- Fabricada en acero inoxidable 18/10 de la mejor calidad.
- Acabado interior lijado satinado y exterior en color rojo/blanco ocean.
- Marcaje de capacidades en el interior (Litros).
- Tapa de vidrio templado con salida de vapor y aro protector de acero inoxidable.
- Tapa diseñada para colocar en el borde de la cacerola.
- Asas ergonómicas fabricadas en acero inoxidable de fundición.
- Fondo termodifusor sandwich (Inox 18/10 - Aluminio - Inoxidable).
- Aptas para todos los fuegos (incluido inducción y horno).

FR

- Fabriqué en acier inoxydable 18/10 de la meilleure qualité.
- Finition intérieure en polissage satiné et l'extérieur rouge/blanc/ocean.
- Marquage des contenances à l'intérieur (litres).
- Couvercle en verre trempé avec sortie de vapeur et anneau de protection en acier inoxydable.
- Couvercle conçu pour être placé sur le bord de la casserole.
- Poignées ergonomiques en acier inoxydable fondu.
- Fond thermodiffuseur sandwich (inox 18/10 - aluminium - inoxydable).
- Aptes pour tous les types de feux (y compris l'induction et le four).

EN

- Made of the highest quality 18/10 stainless steel.
- Glossy sanded interior finish and exterior in red/white/ocean colour.
- Capacity markings on the inside (litres).
- Tempered glass lid with steam outlet and stainless steel protective ring.
- Lid designed to fit on the rim of the pan.
- Ergonomic handles made of cast stainless steel.
- Heat-diffusing sandwiched base (18/10 stainless steel - aluminium - st. Steel).
- Suitable for all types of cookers (including induction hobs and ovens).

## New



### Cacerola con tapa RED

Faitout avec couvercle · Bratentopf mit Deckel  
Casserole with lid · Caçarola com tampa

Ref	€	Ø (cm)	h (cm)	L	U.Venta
15316	39,80	16	8,0	1,50	1
15320	47,50	20	10,0	3,00	1
15324	57,50	24	12,0	5,00	1



### Cacerola con tapa WHITE

Faitout avec couvercle · Bratentopf mit Deckel  
Casserole with lid · Caçarola com tampa

Ref	€	Ø (cm)	h (cm)	L	U.Venta
15416	39,80	16	8,0	1,50	1
15420	47,50	20	10,0	3,00	1
15424	57,60	24	12,0	5,00	1

Diseñada para colocar en el borde de la cacerola  
designed to fit on the rim of the pan



### Cacerola con tapa OCEAN

Faitout avec couvercle · Bratentopf mit Deckel  
Casserole with lid · Caçarola com tampa

Ref	€	Ø (cm)	h (cm)	L	U.Venta
15516	39,80	16	8,0	1,50	1
15520	47,60	20	10,0	3,00	1
15524	57,50	24	12,0	5,00	1



### Tapa

Couvercle · Deckel  
Lid · Tampa

Ref	€	Ø (cm)	U.Venta
15306	9,30	16	1
15302	10,10	20	1
15304	10,80	24	1



# DEGUSTARE

## Vajilla catering



ES

- Vajilla para catering moderna, innovadora y atractiva.
- Ideal para cualquier tipo de celebración como banquetes, bodas, fiestas, etc. Realzan cualquier tipo de catering de alta gama.
- Permite múltiples combinaciones gracias a la variedad de formas.
- Reutilizables e irrompibles. Manejables y ligeros para su transporte.
- 100% apilables.

FR

- Vaisselle pour buffets moderne, innovante et attractive.
- Idéale pour tout type de célébration comme des banquets, mariages, fêtes, etc. Elle sublime tout type de buffet haut de gamme.
- Permet de multiples combinaisons grâce à la variété des formes.
- Pièces réutilisables et incassables. Maniables et légères pour le transport.
- 100% empilable.

EN

- Modern, innovative and attractive catering dinnerware.
- Ideal for any type of celebration, such as banquets, weddings, parties etc. Enhances any kind of high-end catering.
- Perfect for multiple combinations due to the variety of different shapes.
- Reusable and unbreakable.
- Handy and lightweight for transport.
- 100% stackable.



6 pcs

### Vajilla catering

Vaisselle pour la restauration · Catering-Geschirr  
Catering dinnerware · Serviço de catering

	Ref	€	cm	h (cm)	ml	U.Venta	
A	60750	11,30	42x28,5	2,5	-	1	Bandeja · Tray
B	60751	7,60	Ø8,5	5,5	115	1	Bol flor · Flower bowl
C	60752	7,80	8,5x8,5	5,5	80	1	Bol cuadrado · Square bowl
D	60753	7,90	Ø8,0	4,0	100	1	Bol rizado · Round bowl
E	60754	7,80	13x6,5	3,5	35	1	Cuchara · Spoon
F	60755	7,30	Ø6,0	7,5	65	1	Vaso · Glass

## New

# BUFFET & DISPLAY

## Melamina mármol



**New**

**ES**

- Fabricados en melamina de alta calidad.
- Aspecto elegante efecto mármol.
- Diseñados para presentar todo tipo de alimentos tanto fríos como calientes (70°C / -20°C).
- Ideales para exponer en todo tipo de buffet, caterings, etc.
- 100% apilables.
- Prácticos y atractivos. Presentan una funcionalidad y durabilidad inmejorables.
- Fácil limpieza: aptas para el lavavajillas.
- Libres de BPA.

**FR**

- Fabriqué en mélamine de haute qualité.
- Élégant aspect marbré.
- Conçu pour présenter tous types d'aliments, aussi bien chauds que froids (70°C / -20°C).
- Idéal pour la présentation dans tous les types de buffets, traiteurs, etc.
- 100 % empilables.
- Pratiques et attrayants. Fonctionnalité et durabilité imbattables.
- Facile à nettoyer : apte au lave-vaisselle.
- Sans BPA.

**EN**

- Made of high quality melamine.
- Elegant marble appearance.
- Designed for presenting all kinds of food, both cold and hot (70°C / -20°C).
- Perfect for displaying in all kinds of buffets, catering, etc.
- 100% stackable.
- Practical and attractive. Unbeatable functionality and durability.
- Easy to Clean: dishwasher safe.
- BPA free.

Infinidad de combinaciones posibles · Endless possible combinations

**BAJOS · LOW**



**ALTOS · HIGH**



\* Compatibles con las campanas PS (Ref.: 61801-61803)



**Frutero**  
Corbeille à fruits · Obstschüssel  
Fruit basket · Fruteiro

Ref	€	Ø (cm)	h (cm)	L	U.Venta
63252	28,90	23,0	7,5	2,40	1
63253	48,80	30,5	10,0	3,80	1



**Portatartas**  
Porte-gâteau · Tortenständer  
Cake stand · Soporte de bolos

Ref	€	Ø (cm)	h (cm)	U.Venta
63250	22,40	22,5	2,0	1
63251	36,20	33,0	2,0	1

**Soporte**  
Support · Stand  
Stand · Soporte

Ref	€	Ø (cm)	h (cm)	L	U.Venta
63254	9,20	11,5	9,0	0,44	1
63255	10,90	11,5	12,0	0,71	1

Compatible con nuestros portatartas  
Can be used with our cake stand



**Campana cubreplatos PS**  
Cloche couvre plat · Tellerglocke  
Plate Cover · Campânula cobre-pratos

Ref	€	Ø (cm)	h (cm)	Total (cm)	U.Venta
61801	6,50	22,0	9,0	12,0	1
61803	12,10	30,0	13,5	15,5	1



**Campana cubreplatos**  
Cloche couvre plat · Tellerglocke  
Plate Cover · Campânula cobre-pratos

Ref	€	Ø (cm)	h (cm)	Total (cm)	U.Venta
61806	39,40	25	14,0	18,5	1
61809	45,10	29	15,0	20,3	1
61802	48,80	33	17,0	22,3	1

- Cubreplatos en forma de campana semiesférica con pomo.
- Fabricada en PS de alta calidad, libre de BPA.
- Diseñada para exponer todo tipo de alimentos.
- Protege los alimentos de los factores externos, garantizando así la higiene.
- Mantiene los alimentos en perfecto estado de conservación.

- Couvre-assiette en forme de cloche hémisphérique avec bouton.
- Fabriqué en PS de haute qualité, sans BPA.
- Conçue pour présenter tous les types d'aliments.
- Protège les aliments des facteurs extérieurs, garantissant ainsi l'hygiène.
- Maintient les aliments en parfait état de conservation.

- Semi-spherical domed cloche with a knob
- Made of high quality BPA free PS
- Designed for displaying all kinds of food
- Protects food from external factors to guarantee hygiene
- Keeps food in a perfect state of conservation

- Fabricada en vidrio borosilicato de gran calidad y resistente a golpes, altas y bajas temperaturas.
- Protege los alimentos de los factores externos.
- Ideal tanto para conservar como para presentar galletas, bollería, quesos y todo tipo de alimentos.
- Se puede introducir en el microondas, horno y congelador.

- Fabriquée en verre borosilicate de grande qualité et résistante aux chocs ainsi qu'aux basses et hautes températures.
- Protège les aliments des agents externes.
- Idéale aussi bien pour conserver que pour présenter des gâteaux, des viennoiseries, des fromages et tout type d'aliments.
- Peut être mise au micro-ondes, au four ou au congélateur.

- Made of high quality impact resistant borosilicate glass that can withstand high and low temperatures.
- Protects food from external factors.
- Perfect for preserving and presenting biscuits, pastries, cheese or any other kind of food.
- Microwave, oven and freezer safe.

# BUFFET PIZARRA

## Bandejas · Soportes



## New

**Dos asas de acero inoxidable**  
Two stainless steel handles



**Base antideslizante**  
Non-slip base

### Bandeja pizarra con asas

plateau en ardoise avec poignées · Schiefertablett mit Griffen  
Slate tray with handles · Bandeja de ardósia com asas

Ref	€	cm	h (cm)	U.Venta
61230	11,20	40x20	5,0	1
61231	16,20	45,5x30	5,0	1
61232	18,20	53x5x33	5,0	1

- Fabricada en pizarra 100% natural con amplia superficie de apoyo.
- Cuenta con 2 asas laterales de acero inoxidable de gran calidad para transportar con facilidad.
- Diseñada para presentar y servir tapas, aperitivos, postres, etc. de manera moderna y elegante.
- Excelente conductor del frío y del calor, ideal para mantener los aperitivos a la hora de servir.
- Máxima estabilidad: almohadillas antideslizantes en la base.
- Fácil limpieza. Lávala a mano, no es apta para lavavajillas.

- Fabriqué en ardoise 100% naturelle avec une grande surface d'accueil.
- Dispose de 2 poignées latérales en acier inoxydable de grande qualité pour un transport aisé.
- Conçu pour présenter et servir des tapas, apéritifs, desserts, etc. de façon moderne et élégante.
- Excellent conducteur de froid et de chaleur, idéal pour maintenir la température des apéritifs lors du service.
- Stabilité maximale : coussinets antidérapants à la base.
- Nettoyage facile. Le laver à la main, ne doit pas être mis au lave-vaisselle.

- Made of 100% natural slate with a large support surface.
- It has two high quality stainless steel side handles so it's easy to carry.
- It's designed for presenting and serving tapas or appetisers, desserts etc. in a modern and elegant way.
- It's an excellent conductor of hot and cold so it's perfect for keeping appetisers when serving them.
- Maximum Stability: non-slip pads on the base.
- Easy to clean. Wash by hand, not dishwasher safe.

## New



### Plato giratorio pizarra natural

Plateau tournant en ardoise naturelle · Drehteller aus Naturschiefer  
Rotating serving dish in natural slate · Prato giratório em ardósia natural

Ref	€	Ø (cm)	h (cm)	U.Venta
61235	19,90	35	2,5	1

- Fabricada en pizarra 100% natural con amplia superficie de apoyo de Ø35 cm.
- Soporte giratorio de cristal y pie de acero inoxidable, permite una rotación fácil y suave en ambos sentidos.
- Diseñado para presentar y servir tapas, aperitivos, postres, etc.
- Fácil limpieza. No es apta para lavavajillas.

- Fabriqué 100% en ardoise naturelle avec une large surface de support de Ø35 cm.
- Support tournant en verre et pied en acier inoxydable ; permet une rotation facile et douce dans les deux sens.
- Conçu pour présenter et servir des tapas, apéritifs, desserts, etc.
- Nettoyage facile. Ne peut pas aller au lave-vaisselle.

- Made of 100% natural slate and featuring a large Ø 35 cm support surface.
- Revolving glass dish and stainless steel base for easy, smooth rotation in both directions.
- Designed to present and serve snacks, dips, appetisers, desserts, etc.
- Easy to clean. Not dishwasher safe.

## New



### Soporte expositor

Présentoir · Schieferständer  
Display stand · Expositor

	Ref	€	Grande cm	Pequeña cm	h (cm)	U.Venta
A	61233	20,50	35x25	35x15	22	1
B	61234	7,80	20	15	34	1

- Soporte de dos alturas para servir y presentar aperitivos dulces o salados de una forma atractiva y original.
- Compuesto por una estructura fabricada en bambú natural y dos bandejas extraíbles fabricadas en 100% pizarra natural.
- Totalmente desmontable, facilita su limpieza y almacenamiento.
- Fuerte y resistente.
- Medidas pizarra grande: 35x25 cm / Medidas pizarra pequeña: 35x15 cm / Distancia entre pizarras: 12,5 cm.

- Support à deux hauteurs pour servir et présenter des apéritifs sucrés ou salés de façon attractive et originale.
- Composé d'une structure fabriquée en bambou naturel et de deux plateaux extractibles fabriqués 100% en ardoise naturelle.
- Entièrement démontable, ce qui facilite son nettoyage et son rangement.
- Robuste et résistant.
- Dimensions grande ardoise : 35x25 cm / Dimensions petite ardoise : 35x15 cm / Distance entre les ardoises : 12,5 cm.

- Two-tier display stand for serving and presenting sweet or savoury snacks in an attractive, original way.
- Natural bamboo structure with two removable trays made of 100% natural slate.
- Fully collapsible for easy cleaning and storage.
- Strong and resistant.
- Large size slate: 35x25 cm / Small size slate: 35x15 cm / Distance between slates: 12.5 cm.

- Soporte de dos pizarras redondas diseñadas para servir y presentar aperitivos dulces o salados de una forma atractiva y original.
- Estructura metálica interior. Incluye asa para transportar.
- Totalmente desmontable, facilita su limpieza y almacenamiento.
- Medidas pizarra grande: Ø20 cm
- Medidas pizarra pequeña: Ø15 cm
- Distancia entre pizarras: 10 cm

- Support composé de deux ardoises rondes conçues pour servir et présenter des apéritifs sucrés ou salés de façon attractive et originale.
- Structure métallique intérieure. Inclut une poignée pour le déplacer.
- Entièrement démontable, ce qui facilite son nettoyage et son rangement.
- Dimensions grande ardoise : Ø20 cm
- Dimensions petite ardoise : Ø15 cm
- Distance entre les ardoises : 10 cm

- Two-tier round slate display stand designed to serve and present sweet or savoury snacks in an attractive, original way.
- Inner metal structure. Includes handle for easy carrying.
- Fully collapsible for easy cleaning and storage.
- Large size slate: Ø20 cm
- Small size slate: Ø15 cm
- Distance between slates: 10 cm

# CUBERTEROS

## Colección



Inox

### Soporte cubiertos con vasos

Porte couverts avec paniers · Besteckbehälter  
Cutlery holder w/cylinder · Sup. talheres com copos

Ref.	€	cm	Orif.	U.Venta
33124	84,70	29x22x26	4	1
33126	104,10	29x22x38	6	1

### Vasos inox cubertería

Panier pour porte couvert · Besteckköcher  
St. steel cutlery cylinder · Copos p/talheres inóx

Ref.	€	h (cm)	U.Venta
33125	7,60	14	6

### Contenedor cubiertos

Panier à couverts · Besteckköcher  
Cutlery holder · Copos para talheres

Ref.	€	Ø (cm)	h (cm)	L	U.Venta
62962	21,00	12	13,6	1,40	1
62963	24,40	12	18,7	2,00	1

4 compartimentos  
4 compartments  
Hueco · Hollow: 11x25x9 cm



- Recipiente para cubiertos en color negro de polipropileno.
- Ideal para organizar y guardar los cubiertos e utensilios de la cocina.
- No se deforma con el peso de los cubiertos.
- Cómodo de transportar gracias a sus asas laterales.
- Fondo redondeado para un fácil mantenimiento.
- Apilable.

- Pot à couverts en polypropylène noir.
- Idéal pour organiser et ranger les couverts et les ustensiles de cuisine.
- Il ne se déforme pas avec le poids des couverts.
- Confortable à transporter grâce à ses poignées latérales.
- Fond arrondi pour un entretien facile.
- Empilable.

- Black polypropylene cutlery container.
- Ideal for organizing and storing cutlery and kitchen utensils.
- It does not deform with the weight of the cutlery.
- Comfortable to transport thanks to its side handles.
- Rounded bottom for easy maintenance.
- Stackable.

### Cubertero GN 1/1

Range-couverts · Besteckkasten  
Cutlery holder · Bandeja pata talheres

Ref	€	cm	h (cm)	U.Venta
33121	11,20	52,5x32	9,5	1



Trenzados  
Braided



4 compartimentos  
4 compartments

Bastidor cromado reforzado  
Reinforced chrome frame

### Cubertero RATTAN PP

Range-couverts · Besteckkasten  
Cutlery holder · Bandeja pata talheres

Ref	€	cm	h (cm)	Compart.	U.Venta
A 63484	8,40	27x10	4,5	1	1
B 63485	8,40	Ø12	15,0	1	1
C 63491	74,80	53x32,5	9,0	4	1

# PANERAS · FRUTEROS

## Colección



- Cuerpo fabricado en acero al carbono lacado en blanco.
- Tapa fabricada en madera de caucho con orificios de ventilación para una óptima circulación del aire.
- Diseño vintage. Forma rectangular con esquinas redondeadas.
- Diseñado para conservar el pan y otros productos siempre frescos.
- 2 en 1: la tapa de madera de caucho se puede utilizar como tabla de cortar.
- Almacenamiento compacto.

- The body is made of carbon steel with white lacquer.
- The lid is made of rubberwood with ventilation holes for optimum air circulation.
- It has a vintage design. It is rectangular with rounded corners.
- It is designed to keep bread and other products always fresh.
- 2 in 1: The rubberwood lid can be used as a cutting board.
- Compact storage.



Puerta abatible. Capacidad para todo tipo de panes  
Mantiene el pan protegido, prolonga su conservación  
Folding door. Capacity for all kinds of breads  
Keeps the bread protected and prolong its conservation

Inox



### Panera abatible

Paniere rabattable · Abfallen Brotkorb  
Bread bin foldable lid · Cestonreclinável

Ref	€	cm	h (cm)	U.Venta
62944	41,90	44x29	19	1

Inox



### Frutero - Panera INOX

Paniere à fruit et à pain · Brot-/Obstschale  
Fruits and bread basket · Fruteiro-Cesto

Ref	€	Ø (cm)	U.Venta
61821	7,50	20	1
61823	11,30	24	1



A

B

Madera  
caucho  
Rubber  
wood

Fe  
Hierro  
Iron

### Panera NÓRDICA

Boîte à pain · Brotkasten  
Bread basket · Caixa para guardar pão

Ref	€	cm	h (cm)	U.Venta
A 62868	38,60	30x18	12,5	1
B 62869	41,90	42x22,5	12,5	1



### Panera KRAFT

Boîte à pain · Brotkasten  
Bread basket · Caixa para guardar pão

	Ref	€	cm	h max (cm)	h min (cm)	U.Venta
A	63476	13,40	10x10	25	8	1
B	63477	14,30	12x12	25	12	1
C	63478	16,20	15x15	25	12	1
D	63479	18,70	20x20	33	12	1



### Panera TEX

Boîte à pain · Brotkasten  
Bread basket · Caixa para guardar pão

	Ref	€	cm	h max (cm)	h min (cm)	U.Venta
A	63486	13,40	10x10	25	8	1
B	63487	14,30	12x12	25	12	1
C	63488	16,20	15x15	25	12	1
D	63489	18,70	20x20	33	12	1

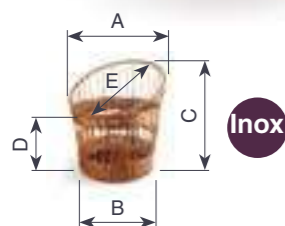

**Inox**  
Estructura de refuerzo de acero inoxidable  
Stainless steel reinforcement structure

### Cesta baguette

Corbeille · Brotkorb  
Basket · Cesta

	Ref	€	ØA (cm)	ØB (cm)	C (cm)	D (cm)	E (cm)	U.Venta
A	63492	62,70	32,0	28,5	42,0	25,0	36,5	1
B	63493	62,70	32,0	28,5	42,0	25,0	36,5	1



- Fabricadas en fibra virgen natural.
- Material ecológico y respetuoso con el medio ambiente.
- Lavables, resistentes y duraderas.
- Diseñadas y fabricadas en España.
- Hechas a mano.
- Tacto agradable y suave, similar a la piel.
- Espesor 0,55 mm.

- Fabriquées en fibres vierges naturelles.
- Matériau écologique et respectueux de l'environnement.
- Lavables, résistantes et durables.
- Conçues et fabriquées en Espagne.
- Faites à la main.
- Toucher agréable et doux, similaire au cuir.
- Épaisseur de 0,55 mm.

- Made of natural virgin fibre.
- Ecological material respectful with the environment.
- Washable, resistant and durable.
- Designed and manufactured in Spain.
- Handmade.
- Nice soft feel, similar to leather.
- Thickness 0.55 mm.



- Cestas para pan fabricadas en polipropileno.
- Diseñadas para uso intensivo.
- Estructura de refuerzo de acero inoxidable. Parte trasera más alta que proporciona suficiente apoyo para panes largos (63492-63493).
- Material con aspecto de mimbre muy resistente, libre de BPA.
- Elaboradas a mano.
- Prácticas e higiénicas. Acabado en mate.
- Ideales para almacenar y exponer panes.
- Apilables.
- Fácil limpieza.

- Paniers pour pain fabriqués en polypropylène.
- Conçu pour une utilisation intensive.
- Structure renforcée en acier inoxydable. Partie arrière plus haute afin d'offrir un meilleur support aux pains longs (63792-63493).
- Matériau très résistant à l'aspect de rotin, sans BPA.
- Fait à la main.
- Pratiques et hygiéniques. Fini mat.
- Parfaits pour ranger et exposer des pains.
- Empilables.
- Faciles à nettoyer.

- These bread baskets are made of polypropylene.
- Designed for intensive use.
- Stainless steel reinforcement structure. The taller back gives plenty support for long loaves of bread (63792-63493).
- The very strong material looks like wicker and it's BPA free.
- Handmade.
- They're practical and hygienic. Matte finish.
- Perfect for storing or displaying bread.
- Stackable.
- Easy to clean.

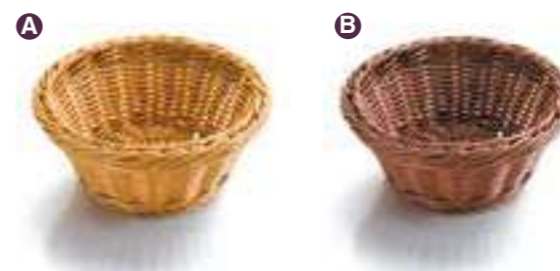

### Cesta de pan redonda

Corbeille a pain ronde · Brotkorb, rund  
Round bread basket · Cesta de pão redonda

	Ref	€	Ø (cm)	h (cm)	U.Venta
	63471	7,70	19	8	1
A	63472	8,60	21	8	1
	63473	9,20	23	8	1
	63474	9,80	28	8	1
	63871	7,80	19	8	1
B	63872	8,60	21	8	1
	63873	9,20	23	8	1
	63874	9,90	28	8	1



### Cesta de pan oval

Corbeille a pain ovale · Brotkorb, Oval  
Oval bread basket · Cesta de pão oval

	Ref	€	cm	h (cm)	U.Venta
	63480	7,00	19x14	8,0	1
A	63481	8,30	24x17	8,0	1
	63482	10,10	28x16	8,5	1
	63880	7,00	19x14	8,0	1
B	63881	8,20	24x17	8,0	1
	63882	10,10	28x16	8,5	1



### Cesta de pan

Corbeille a pain · Brotkorb  
Bread basket · Cesta de pão

	Ref	€	Ø (cm)	h (cm)	U.Venta
A	63494	30,00	35	20	1
B	63894	29,50	35	20	1



### Cesta de pan cuadrada

Corbeille a pain carré · Brotkorb, viereckig  
Square bread basket · Cesta de pão quadrada

	Ref	€	cm	h (cm)	U.Venta
A	63490	34,30	53x33,5	9	1
B	63890	34,00	53x33,5	9	1

**New**

Medidas · Sizes  
19,5x17,5x7 cm



Medidas · Sizes  
29x18x8 cm

**Frutero DUAL SQ**  
Corbeille à fruits · Obstskorb  
Fruit basket · Fruteira

Ref	€	cm	h (cm)	U.Venta
61124	18,80	29x18,5	33,5	4



- Frutero de doble altura fabricado en metal y acabado negro mate.
- Asa fabricada en madera de caucho.
- Diseño transpirable: permite que el aire circule mejor, manteniendo así las frutas y verduras siempre frescas.
- 100% estable y resistente.
- Desmontable: las cestas se pueden utilizar por separado.
- Versátil: ideal para fruta, verdura, tarros de conservas, etc.

- Corbeille à fruits à double hauteur fabriquée en métal et finition noir mat.
- Poignée fabriquée en bois de caoutchouc.
- Conception aérée : permet à l'air de mieux circuler, maintenant ainsi les fruits et les légumes toujours frais.
- 100% stable et résistante.
- Démontable : les paniers peuvent être utilisés séparément.
- Polyvalente : idéale pour les fruits, les légumes, pots de conserve, etc.
- Two tier fruit basket made of metal with a matte black.
- Handle made of rubber wood.
- The breathable design lets air circulate better to keep your fruit and vegetables fresh all the time.
- 100% stable and resistant.
- Detachable: the baskets can be used separately.
- Versatile: perfect for fruit, vegetables, canning jars, etc.

Madera contrachapada color haya  
Plywood beech color

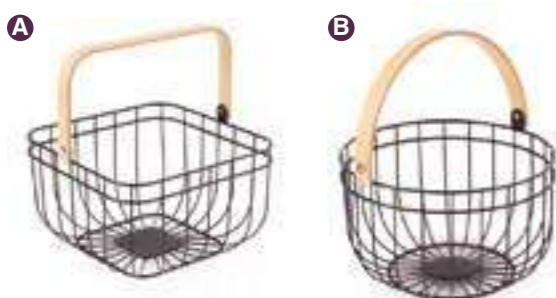

**Frutero varillas**

Corbeille à fruits · Obstschale aus Gitterstäben  
Square fruit bowl · Cesto de metal para fruta

Ref	€	Cesta (cm)	h Total (cm)	ØVarilla (mm)	U.Venta
A 61137	34,40	26x26x18,3	27,8	4	1
B 61138	34,40	Ø25,2x17,7	28,9	4	1

Madera aglomerada  
Agglomerate wood

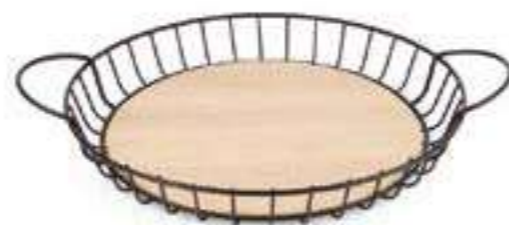

**Frutero varillas redondo bajo**

Corbeille à fruits ronde basse · Obstschale aus Gitterstäben  
Round low rod fruit bowl · Cesto de metal para fruta redondo baixo

Ref	€	Cesta (cm)	h (cm)	Ø Base (mm)	ØVarilla (mm)	U.Venta
61139	39,70	Ø39x6	7,6	31,3	4	1



Ideales para almacenar fruta, pan, verduras, huevos, etc.  
Can be used for storing fruit, bread, vegetables, eggs, etc.

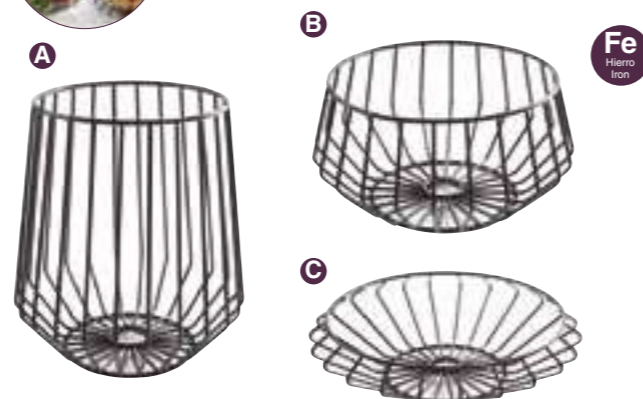

**Frutero varillas DUAL**

Corbeille à fruits · Obstschale aus Gitterstäben  
Rod fruit bowl · Cesto de metal para fruta

Ref	€	Grande (cm)	Peq. (cm)	h (cm)	ØVarilla (mm)	U.Venta
61140	53,40	Ø40x10	Ø24x10	63	4	1

**Frutero varillas**

Corbeille à fruits · Obstschale aus Gitterstäben  
Rod fruit bowl · Cesto de metal para fruta

Ref	€	Ø (cm)	h (cm)	ØVarilla (mm)	U.Venta
A 61126	22,90	23,4	25,4	4	2
B 61127	20,80	27,0	13,8	4	1
C 61128	22,00	34,0	9,5	4	1

# TOSTADORAS BUFFET

## Colección



**Tostado continuo de pan**  
Doble sistema de calentamiento  
Cinta transportadora  
Bandeja de recogida de migas  
Continuous bread toasting  
Dual heating system  
Conveyor belt  
Crumb collection tray



**Características · Characteristics:**

Referencia · Reference: 69065  
Tensión · Voltage: 220-240 V; 50Hz  
Potencia · Power: 1340 W  
Velocidad · Speed: 0,46 - 0,73 m/min  
Producción · Production: 150 h  
Dimensiones · Sizes: 53x37x40 cm  
Peso · Weight: 12,85 kg

**Características · Characteristics:**

Referencia · Reference: 69066  
Tensión · Voltage: 220-240 V; 50Hz  
Potencia · Power: 2240 W  
Velocidad · Speed: 0,46 - 0,73 m/min  
Producción · Production: 300 h  
Dimensiones · Sizes: 53x45x40 cm  
Peso · Weight: 15,50 kg

**Tostador CONTINUE**

Grille-painl · Toaster  
Toaster · Torradeira

Ref	€	W	U.Venta
69065	835,90	1340	1
69066	964,10	2240	1

**Calentamiento infrarrojos**  
Lámparas infrarrojas halógenas de cuarzo  
Hueco útil entre parrillas 5,5 cm  
Bandeja recogemigas  
Infrared heating Quartz halogen infrared lamps  
Usable gap between racks 5.5 cm  
Crumbs tray



**Características · Characteristics:**

Referencia · Reference: 69172  
Tensión · Voltage: 220-240 V; 50-60 Hz  
Potencia · Power: 2400 W  
Lámparas · Lamps: 6 (3+3)  
Parrilla · Grill: 40x24 cm  
Dimensiones · Sizes: 50x25x28 cm  
Peso · Weight: 7,10 kg

**Tostador HORIZONTAL**

Grille-painl · Toaster  
Toaster · Torradeira

Ref	€	W	U.Venta
A 69172	354,30	2400	1
B 69173	418,80	3150	1

**Ranuras de grandes dimensiones**  
Bandeja recogemigas  
Huge slots for toasting  
Crumbs tray



4  
Ranuras  
Slots

**Características · Characteristics:**

Referencia · Reference: 69264  
Tensión · Voltage: 220-240 V; 50-60 Hz  
Potencia · Power: 1800 W  
Selector · Selector: 2/4 ranuras · groves  
Ranura · Slot: 15x3 cm  
Dimensiones · Sizes: 29x26x22 cm  
Peso · Weight: 3,90 kg

**Tostador BUFFET**

Grille-painl · Toaster  
Toaster · Torradeira

Ref	€	Ranuras	U.Venta
A 69294	230,70	4	1
B 69296	306,40	6	1



6  
Ranuras  
Slots

**Características · Characteristics:**

Referencia · Reference: 69266  
Tensión · Voltage: 220-240 V; 50-60 Hz  
Potencia · Power: 2500 W  
Selector · Selector: 2/4/6 ranuras · groves  
Ranura · Slot: 15x3 cm  
Dimensiones · Sizes: 42x26x22 cm  
Peso · Weight: 5,00 kg



**Doble ranura extralarga diseñada para tostar todo tipo de panes**  
Extra-long double slot toaster designed to toast all types of bread

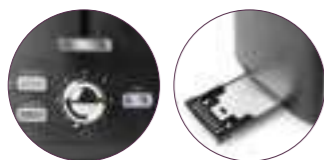

### Tostadora LONG

Grille-pain · Toaster  
Toaster · Torradeira

Ref	€	W	U.Venta
69260	57,60	1500	1

## Inox New design

- Tostadora de doble ranura extralarga diseñada para tostar todo tipo de panes.
- Fabricada en acero inoxidable de gran calidad.
- Práctica, segura y muy fácil de usar.
- Función de descongelación (Defrost), calentamiento (Reheat) y cancelación (Stop).
- Bandeja recogemigas para facilitar la limpieza.
- Dispone de 7 niveles de tostado. Medidas de la ranura: 25 x 4 cm.

- Grille-pain à double rainure extra-large conçu pour griller tout type de pains.
- Fabriqué en acier inoxydable de grande qualité.
- Pratique, sûr et très facile à utiliser.
- Fonction de décongélation (Defrost), réchauffage (Reheat) et annulation (Stop).
- Plateau ramasse-miettes pour faciliter le nettoyage.
- Dispose de 7 niveaux de brunissage. Dimensions de la rainure : 25 x 4 cm.

- Extra-long double slot toaster designed to toast all types of bread.
- Made of high quality stainless steel.
- Practical, safe and easy to use.
- DEFROST, REHEAT and CANCEL functions.
- Removable crumb tray for easy cleaning.
- 7 browning levels. Slot dimensions: 25 x 4 cm

#### Características · Characteristics:

**Referencia** · Reference: 69260  
**Tensión** · Voltage: 220-240 V; 50-60 Hz  
**Potencia** · Power: 1400 W  
**Dimensiones** · Sizes: 38x18x20 cm  
**Peso** · Weight: 1,70 kg

- Fabricada en acero inoxidable 18/10 de gran calidad y resistencia
- Permite tostar de forma rápida y sencilla, sin necesidad de añadir grasa alguna
- Función de descongelación y cancelación
- Regulador ajustable de tueste, elige entre 7 niveles para tostar a tu gusto
- Ranura alargada de 25 cm de largo para rebanadas extra largas o para más de una rebanada de pan
- Incorpora una práctica bandeja, donde se depositan las migas

- Fabriqué en acier inoxydable 18/10 d'une grande qualité et résistance
- Permet de griller de façon rapide et simple sans nécessité d'ajouter aucune graisse
- Fonction de décongélation et d'arrêt
- Régulateur de brunissage réglable : choisissez parmi 7 niveaux pour griller selon vos souhaits
- Rainure allongée de 25 cm de longueur pour des tranches extra larges ou pour plus d'une tranche de pain
- Intègre un plateau pratique sur lequel se déposent les miettes

- Made of strong high quality 18/10 stainless steel
- Fast and easy toasting without the need to use any fatty products
- Defrost and cancel functions
- Adjustable darkness regulator. Choose from 7 levels for toasting as you like.
- Long 25 cm slot for extra wide slices of bread or more than one slice of bread at once
- It has a practical tray for catching crumbs

#### Características · Characteristics:

**Referencia** · Reference: 69360  
**Tensión** · Voltage: 220-240 V; 50-60 Hz  
**Potencia** · Power: 1000 W  
**Dimensiones** · Sizes: 41x12x18,5 cm  
**Peso** · Weight: 1,40 kg



**Ranura extralarga diseñada para tostar todo tipo de panes**  
Extra-long slot toaster designed to toast all types of bread



### Tostadora DUPLO

Grille-pain · Toaster  
Toaster · Torradeira

Ref	€	W	U.Venta
69360	63,70	1000	1



### Tostadora horizontal

Toaster horizontal · Horizontal-/Toaster  
Electric toaster · Torradeira horizontal

	Ref	€	W	U.Venta
A	69163	33,00	600	1 BASIC
B	69363	41,30	600	1 EASY

## CHOCOLATE Fuentes



### Fuente de chocolate

Fontaine chocolat · Schokoladen Fontäne  
Chocolate fountain · Fonte chocolate

	Ref	€	Tower	U.Venta
A	69318	60,10	18 cm	1
B	69319	102,20	38 cm	1

- Gracias a su diseño y área de calentamiento podrá tostar todo tipo de panes o bollería y varias rebanadas a la vez.
- Grâce à sa conception et sa zone de chauffe, vous pourrez griller tout type de pains ou de viennoiseries et plusieurs tranches à la fois.
- Dank des Designs und des Erwärmungsbereichs können Sie alle möglichen Brotsorten und mehrere Scheiben gleichzeitig tosten.
- Thanks to its design and heating area you will be able to toast all types of bread and pastries, and several slices at a time.
- Graças ao seu desenho e área de aquecimento, poderá tostar todo o tipo de pães ou bolos, e várias fatias ao mesmo tempo.

#### Características · Characteristics:

**Referencia** · Reference: 69163  
**Tensión** · Voltage: 220-240 V; 50-60 Hz  
**Potencia** · Power: 600 W  
**Temperatura** · Temperature: 360°C  
**Tostado** · Toasted: 6  
**Parrilla** · Grill: 25x20 cm  
**Dimensiones** · Sizes: 36x21x6,5 cm  
**Peso** · Weight: 1,00 kg

#### Características · Characteristics:

**Referencia** · Reference: 69363  
**Tensión** · Voltage: 220-240 V; 50-60 Hz  
**Potencia** · Power: 600 W  
**Temperatura** · Temperature: 360°C  
**Tostado** · Toasted: 6  
**Parrilla** · Grill: 25x20 cm  
**Dimensiones** · Sizes: 42x30x9 cm  
**Peso** · Weight: 1,00 kg



- Fabricada en acero inoxidable 18/10 de gran calidad.
- Crea una cascada de chocolate fundido y lo mantiene caliente para bañar alimentos.
- Ideal para buffet, hoteles, restaurantes, estas y celebraciones.
- Interruptor de calentamiento independiente.
- Base con apoyos antideslizantes.
- Desmontable.

- Made of high quality 18/10 stainless steel.
- Creates a cascade of melted chocolate and keeps it warm for dipping foods.
- Ideal for buffets, hotels, restaurants, parties and celebrations.
- Independent heating switch.
- Base with non-slip feet.
- Removable

#### Características · Characteristics:

**Referencia** · Reference: 69318  
**Tensión** · Voltage: 220-240 V; 50-60 Hz  
**Potencia** · Power: 35 W  
**Temperatura** · Temperature: 40°C-50°C  
**Capacidad** · Capacity: 0,50 L  
**Dimensiones** · Sizes: Ø16x30 cm  
**Peso** · Weight: 1,15 kg

#### Características · Characteristics:

**Referencia** · Reference: 69319  
**Tensión** · Voltage: 220-240 V; 50-60 Hz  
**Potencia** · Power: 80 W  
**Temperatura** · Temperature: 40°C-50°C  
**Capacidad** · Capacity: 1,80 L  
**Dimensiones** · Sizes: Ø23x54,5 cm  
**Peso** · Weight: 2,05kg



# PLACAS INDUCCIÓN

## Colección



ES

- Placas de inducción rápidas, eficaces, seguras, fiables y de gran capacidad de calentamiento.
- Sus diseños portátiles y compactos resultan ideales para su uso en cualquier lugar.
- Botones táctiles, intuitivos y fáciles de utilizar con un toque suave.
- Dispone de función de bloqueo de seguridad para niños.
- 40% ahorro de tiempo y energía respecto a otras placas convencionales.

FR

- Plaque à induction rapide, efficace, sûre, fiable et d'une grande capacité de chauffe.
- Sa conception portable et compacte est idéale pour une utilisation n'importe où.
- Boutons tactiles, intuitifs et faciles à utiliser avec un toucher doux.
- Dispose d'une fonction de blocage de sécurité pour les enfants.
- 40% de gain de temps et d'économies d'énergies par rapport à d'autres plaques conventionnelles.

EN

- Fast, efficient, safe, reliable induction hob with high heating capacity.
- Its portable and compact design is ideal for use anywhere.
- Intuitive and easy to use soft touch buttons.
- Includes a child safety lock function.
- 40% saving in time and energy compared to other conventional hobs.

Superficie de calentamiento  
Heating surface



IPX3  
proof

Superficie de calentamiento  
Heating surface



### Placa inducción profesional CHEF

Plaque induction professionnelle · Profi-Induktionsplatte  
Professional induction cooktop · Placa de indução profissional

Ref	€	W	U.Venta
69132	431,40	3500	1

### Placa inducción profesional ROCA

Plaque induction professionnelle · Profi-Induktionsplatte  
Professional induction cooktop · Placa de indução profissional

Ref	€	W	U.Venta
69337	364,70	2700	1

Ref	Tensión/Voltage	Potencia/Power	Niveles Pot. /P. levels	Temperatura/Temp.	Reloj/Timer	Dimensiones/Sizes	Peso/Weight
69132	220-240 V; 50/60 Hz	3500 W	17	35°C - 240°C	0 - 180 min	34x43x12 cm	7,35 Kg
69337	220-240 V; 50/60 Hz	2700 W	10	60°C - 240°C	0 - 180 min	30x39x10 cm	5,40 Kg

Superficie de calentamiento  
Heating surface



### Placa inducción profesional EASY

Plaque induction professionnelle · Profi-Induktionsplatte  
Professional induction cooktop · Placa de indução profissional

Ref	€	W	U.Venta
69362	370,10	3500	1

Superficie de calentamiento  
Heating surface



Posibilidad de encastrar  
Encastrable option

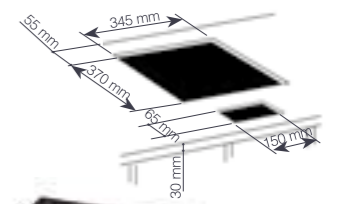

Regulable en potencia  
Adjustable in power

### Placa de inducción PRO

Table de cuisine à induction · Induktionskochfeld  
Induction cooker · Placa de indução

Ref	€	W	U.Venta
69371	333,90	500/3500	1

Superficie de calentamiento  
Heating surface



Posibilidad de encastrar  
Encastrable option

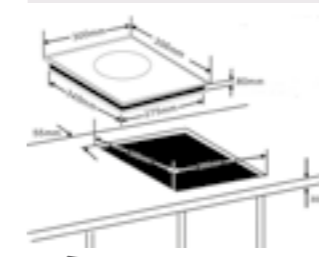

### Placa de inducción EXPERT

Table de cuisine à induction · Induktionskochfeld  
Induction cooker · Placa de indução

Ref	€	W	U.Venta
69032	279,30	2000	1

Superficie de calentamiento  
Heating surface

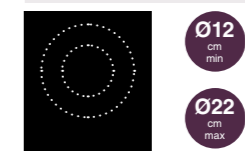

### Placa de inducción SLIM

Table de cuisine à Induktion · Induktionskochfeld  
Induction cooker · Placa de indução

Ref	€	W	U.Venta
69332	158,40	2000	1

Ref	Tensión/Voltage	Potencia/Power	Niveles Pot. /P. levels	Reloj/Timer	Dimensiones/Sizes	Peso/Weight
69032	220-240 V; 50/60 Hz	2000 W	6	0 - 180 min	31x36x7,5 cm	2,90 Kg
69332	220-240 V; 50/60 Hz	2000 W	8	0 - 180 min	30x37x4,5 cm	2,67 Kg



### Placa inducción DUAL VERTICAL

Plaque induction double · Induktionskochfeld doppelt  
Double induction cooktop · Placa de indução dupla

Ref	€	W	U.Venta
69033	457,20	1800+1300	1



### Placa inducción DUAL HORIZONTAL

Plaque induction · Induktionskochfeld doppelt  
Induction cooktop · Placa de indução

Ref	€	W	U.Venta
69333	270,20	2000+1500	1

Ref	Tensión/Voltage	Potencia/Power	Niveles Pot./P. levels	Reloj/Timer	Dimensiones/Sizes	Peso/Weight
69033	220-240 V; 50/60 Hz	1800 +1300 W	8	0 - 99 min	29x51x9 cm	4,50 Kg
69333	220-240 V; 50/60 Hz	2000 W + 1500 W	7	0 - 180 min	60x34x7,5 cm	5,20 Kg

- Cuerpo fabricado en 3 capas: acero inoxidable 18/10, aluminio, acero inoxidable 18%.
- La capa exterior es de acero inoxidable con componentes ferríticos, lo que la convierte totalmente compatible con las cocinas de inducción.
- Los mango fabricado en acero inoxidable 18/10 y recubierto con un protector térmico de silicona

- Body manufactured in a 3-layered: 18/19 stainless steel, aluminium, 18% stainless steel.
- Exterior layer, of stainless steel with ferrite materials, making it completely compatible with induction cookers.
- The grip are made in 18/10 stainless steel and covered in a silicon heat protection.

Placa cerámica: Ø26 cm  
Ceramic plate: Ø26 cm

Inox



### Placa inducción wok Profesional

Plaque à induction wok professionnelle · Induktionskochplatte wok professional  
Induction cooktop wok professional · Placa indução wok profissional

Ref	€	U.Venta
69138	448,00	1



### Wok Trimetal

Wok Trimetal · Wok, Trimetal  
Trimetal wok · Wok Trimetal

Ref	€	Ø (cm)	L
53836	174,40	36	5,50

Ref	Tensión/Voltage	Potencia/Power	Temperatura/Temp	Tiempo/Timer	Dimensiones/Sizes	Peso/Weight
69138	220-240 V; 50/60 Hz	3500 W	60°C - 240°C	0 - 180 min	34x44,5x12,5 cm	7,50 Kg

# ENERGY

## Placa vitrocerámica



Superficie de calentamiento  
Heating surface



### Placa vitrocerámica ENERGY

Plaque vitrocéramique · Keramikkochfeld  
Ceramic hob · Placa vitrocerámica

Ref	€	W	U.Venta
69232	112,30	2000	1

- Placa vitrocerámica rápida, eficaz, segura, fiable y de gran capacidad de calentamiento.
- Su diseño portátil y compacto resulta ideal para su uso en cualquier lugar.
- Área de cocción de 10 cm / 20 cm de diámetro.
- Botones táctiles, intuitivos y fáciles de utilizar con un toque suave.
- Indicadores luminosos.
- Dispone de función de bloqueo de seguridad para niños.
- Regulable en potencia y temperatura.
- Temporizador de 240 minutos con avisador acústico y auto desconexión.

- Plaque vitrocéramique rapide, efficace, sûre, fiable et d'une grande capacité de chauffe.
- Sa conception portable et compacte est idéale pour une utilisation n'importe où.
- Zone de cuisson de 10 cm / 20 cm de diamètre.
- Boutons tactiles, intuitifs et faciles à utiliser avec un toucher doux.
- Indicateurs lumineux.
- Dispose d'une fonction de blocage de sécurité pour les enfants.
- Réglable en puissance et en température.
- Minuteur de 240 minutes avec alerte sonore et arrêt automatique.

- Fast, efficient, safe, reliable ceramic hob with high heating capacity.
- Its portable and compact design is ideal for use anywhere.
- 10 cm / 20 cm diameter cooking area.
- Intuitive and easy to use soft touch buttons.
- Luminous indicators.
- Includes a child safety lock function.
- Adjustable power and temperature.
- 240-minute timer with audible warning and auto-off.

Ref	Tensión/Voltage	Potencia/Power	Temperatura/Temp.	Temporizador/Timer	Ø cocción/Cooking	Dimensiones/Sizes	Peso/Weight
69232	220-240 V; 50/60 Hz	2000 W (8 levels)	60°C - 600°C (8 levels)	0 - 240 min (8 levels)	10 cm / 20 cm	39x32x5,5 cm	2,60 Kg

# PLACA CALENTAMIENTO

## Colección

· Professional use ·



### Calentador BUFFET 3x GN 1/3

Chauffe · Warmer  
Warmer · Aquecedor

Ref	€	W	U.Venta
69445	99,70	300	1



### Placa calentamiento

Plaque pour Chauffante · Warmhalteplatte  
Warming Plate · Placa aquecimiento

Ref	€	W	U.Venta
69045	92,50	300	1



### Placa calentamiento Vitrocerámica

Plaque vitrocéramique chaleur · Glaskeramikheizplatte  
Hob heating plate · Placa aquecimiento vitrocerámica

Ref	€	W	U.Venta
69145	204,70	230	1

- Una solución perfecta para profesionales de hostelería, buffet, eventos, catering, ferias, etc.
- Ideal para mantener los alimentos calientes antes de servirlos en la mesa a una temperatura perfecta.
- NO cocinar sobre la misma placa.

- Une solution parfaite pour les professionnels de l'hôtellerie, buffets, événements, traiteurs, salons, etc.
- Idéale pour garder au chaud d'aliments avant de les servir à table à une température parfaite.
- NE PAS cuisiner sur la même plaque.

- A perfect solution for hospitality, buffet, events, catering and trade show professionals...
- Ideal for keeping the food warm before serving them at a perfect temperature.
- DO NOT cook on the same tray.

- Una solución perfecta para profesionales de hostelería, buffet, eventos, catering, ferias, etc.
- Ideal para mantener tanto platos como bandejas de alimentos calientes antes de servirlos en la mesa a una temperatura perfecta.
- Fabricada en vidrio templado con un marco de aluminio.
- Termostato regulable en temperatura (65°C - 105°C).
- Prohibido cocinar sobre la misma placa.

- Une solution parfaite pour les professionnels de l'hôtellerie, buffets, événements, traiteurs, salons, etc.
- Idéale pour garder au chaud aussi bien les assiettes que les plats d'aliments avant de les servir à table à une température parfaite.
- Fabriqué en verre trempé avec un cadre en aluminium.
- Thermostat réglable en température (65°C - 105°C).
- Il est strictement interdit de cuisiner sur la plaque.

- A perfect solution for hospitality, buffet, events, catering and trade show professionals, etc.
- Ideal for keeping both dishes and trays of food warm before serving them at a perfect temperature.
- Made of tempered glass with an aluminum frame.
- Temperature-adjustable thermostat (65°C - 105°C).
- Do not cook on the hot plate.

**New**



### Placa calentamiento Vitrocerámica

Plaque vitrocéramique chaleur · Glaskeramikheizplatte  
Hob heating plate · Placa aquecimiento vitrocerámica

Ref	€	W	U.Venta
69446	101,30	230	1

# BUFFET

## Calentador



ES

- Ideal para grandes cocinas, buffet, catering o comedores.
- Mantiene los platos a temperatura perfecta durante un tiempo prolongado.
- Estructura de acero inoxidable de alta calidad y resistente.
- Placa calentadora de acero inoxidable con regulación de temperatura entre 40°C - 90°C.
- Lámparas halógenas para garantizar una temperatura homogénea con regulación independiente para cada una de ellas.
- Pantalla protectora de plexiglás altamente resistente.

FR

- Idéal pour grandes cuisines, buffets, traiteurs ou cantines.
- Maintient les plats à la température parfaite pendant un laps de temps prolongé.
- Structure en acier inoxydable de grande qualité et résistant.
- Plaque chauffante en acier inoxydable avec réglage de température de 40°C à 90°C.
- Ampoules halogènes pour garantir une température homogène avec réglage indépendant pour chacune d'entre elles.
- Écran de protection en plexiglas hautement résistant.

EN

- Perfect for large kitchens, buffets, catering or dining rooms.
- It keeps food at the perfect temperature for an extended period.
- Durable high quality stainless steel structure.
- Stainless steel heating plate with adjustable temperature from 40° C to 90° C.
- The halogen lamps guarantee even temperature and each one can be adjusted independently.
- High impact perspex safety screen.



Incluye bombillas infrarrojos (Ref.: R69061A)  
Includes infrared heating bulbs



### Calentador BUFFET DUAL

Plaque électrique · Warmhalteplatte  
Electric warming plate · Placa aquecimiento eléctrico

Ref	€	W (Placa)	W (Lámp.)	U.Venta
69562	519,20	500	2x250	1



### Calentador BUFFET TRIPLE

Plaque électrique · Warmhalteplatte  
Electric warming plate · Placa aquecimiento eléctrico

Ref	€	W (Placa)	W (Lámp.)	U.Venta
69563	684,10	650	3x250	1

Ref	Tensión/Voltage	Potencia/Power	Contenedor/Container	Temp. máx./ Max. temp.	Placa/Plate	Dimensiones/Sizes	Peso/Weight
69445	220-240 V; 50/60 Hz	300 W	GN 1/3 - 2,5 L (3)	80°C (max)	53x35,8 cm	65x38x15,4 cm	4,20 Kg
69045	220-240 V; 50/60 Hz	300 W	-	80°C (max)	53x35,5 cm	65x38x6,2 cm	2,60 Kg
69145	220-240 V; 50/60 Hz	230 W	-	60°C - 105°C (max)	55x36,5 cm	62x36,5x4,5 cm	4,10 Kg
69446	220-240 V; 50/60 Hz	230 W	-	60°C - 105°C (max)	38x45 cm	58x38x2,5 cm	3,54 Kg

Ref	Tensión/Voltage	Pot. Placa/Plate P.	Nº Lámp./Lamps	Pot. Lámp./Lamp P.	Temperatura/Temp.	Dimensiones/Sizes	Peso/Weight
69562	220-240 V; 50/60 Hz	500 W	2	250 W	40°C - 90°C	78x53x70 cm	12,5 Kg
69563	220-240 V; 50/60 Hz	650 W	3	250 W	40°C - 90°C	107x53x70 cm	16,5 Kg

# CALENTAMIENTO

## Lámparas

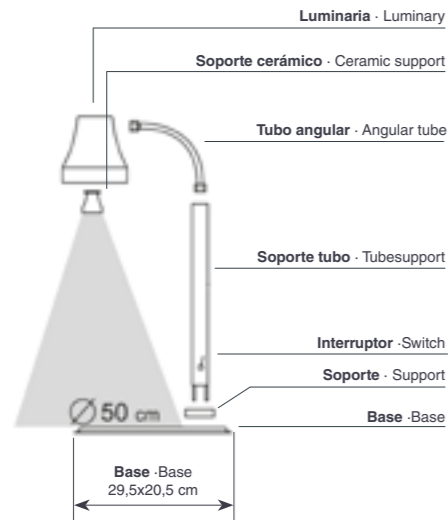

- Para uso profesional en hostelería.
- Mantiene calientes los platos. Calentamiento por infrarrojos.
- Se aconseja mantener la lámpara a 50 - 60 cm de distancia de los platos.
- Bombilla para todas nuestras lámparas de calentamiento.

- Pour un usage professionnel en hôtellerie.
- Maintient les plats au chaud. Chauffe par infrarouges.
- Il est conseillé de maintenir la lampe à une distance de 50 - 60 cm des plats.
- Ampoule pour toutes nos lampes chauffantes.

- For professional catering use.
- Hält die Speisen warm. Infrarot heating.
- It is recommended that the lamp is kept at a distance of 50-60cm from the plates.
- Bulb for all our heating lamps..



**Incluye bombillas infrarrojos (Ref.: R69061A)**  
Includes infrared heating bulbs

**Apta para todas nuestras lámparas de calentamiento**  
Suitable for all our heating lamps

**Bombilla infrarrojos**  
Ampoule infrarouge · Infrarot Glühbirne  
Infrared heating bulb · Lampada infravermelho

Ref	€	W	U.Venta
R69061A	9,80	275	1



**Lámpara calentamiento infrarrojos**  
Lampe de chauffage infrarouge · Infrarot Wärmelampe  
Infrared heating lamp · Lampara calor infravermelho

Ref	€	W	U.Venta
<b>A</b> 69361	105,10	275	1
<b>B</b> 69061	145,40	550	1

Ref	Tensión/Voltage	Potencia/Power	Dimensiones/Sizes	Peso/Weight
69361	220-240 V; 50/60 Hz	275 W	34x33x56 -71 cm	1,15 Kg
69061	220-240 V; 50/60 Hz	550 W	36x45x61 - 75 cm	1,58 Kg
69263	220-240 V; 50/60 Hz	275 W	31x23x79 cm	6,0 Kg
69264	220-240 V; 50/60 Hz	550 W	36x36x76 cm	7,0 Kg



**Lámpara de calentamiento infrarrojos**  
Lampe de chauffage infrarouge · Infrarot Wärmelampe  
Infrared heating lamp · Lampara calor infravermelho

Ref	€	W	U.Venta
<b>A</b> 69263	473,50	275	1
<b>B</b> 69264	615,50	550	1

# CALENTAMIENTO

## Lámparas extensibles

· Professional use ·



- Para uso profesional en hostelería.
- Mantiene calientes los platos. Calentamiento por infrarrojos.
- Se aconseja mantener la lámpara a 50 - 60 cm de distancia de los platos.
- Bombilla para todas nuestras lámparas de calentamiento.

- Pour un usage professionnel en hôtellerie.
- Maintient les plats au chaud. Chauffe par infrarouges.
- Il est conseillé de maintenir la lampe à une distance de 50 - 60 cm des plats.
- Ampoule pour toutes nos lampes chauffantes.

- For professional catering use.
- Keeps the dishes warm. Infrared heating.
- It is recommended that the lamp is kept at a distance of 50-60cm from the plates.
- Bulb for all our heating lamps.



**Incluye bombillas infrarrojos (Ref.: R69061A)**  
Includes infrared heating bulbs



**Lámpara calentamiento infrarrojos cable extensible**  
Lampe de chauffage câble extensible · Infrarot Wärmelampe Kabel ausziehbar  
Infrared heating lamp extensible · Lampara calor infravermelho cabo extensível

Ref	€	W	U.Venta	Color
<b>A</b> 69266	126,70	275	1	Lijado · Sanding
<b>B</b> 69365	145,60	275	1	Cromado · Chrome
<b>C</b> 69367	145,60	275	1	Cobre · Copper
<b>D</b> 69359	137,40	275	1	Negra · Black

**Lámpara de calentamiento extensible cónica**  
Lampe chauffante extensible conique · Wärmelampe Kabel ausziehbar, konisch  
Conical heating lamp extensible · Lampada de aquecimento ext. cônica

Ref	€	W	U.Venta	Color
<b>A</b> 69564	131,20	275	1	Lijado · Sanding
<b>B</b> 69566	157,50	275	1	Cromado · Chrome
<b>C</b> 69565	160,20	275	1	Cobre · Copper
<b>D</b> 69576	147,00	275	1	Negra · Black

Ref	Tensión/Voltage	Potencia/Power	Dist. lámp. alimentos Lamp-food distance	Peso/Weight
69266	220-240 V; 50/60 Hz	275 W	50 - 60 cm	2,00 Kg
69365	220-240 V; 50/60 Hz	275 W	50 - 60 cm	2,00 Kg
69367	220-240 V; 50/60 Hz	275 W	50 - 60 cm	2,00 Kg
69359	220-240 V; 50/60 Hz	275 W	50 - 60 cm	2,00 Kg
69564	220-240 V; 50/60 Hz	275 W	50 - 60 cm	1,60 Kg
69566	220-240 V; 50/60 Hz	275 W	50 - 60 cm	1,60 Kg
69565	220-240 V; 50/60 Hz	275 W	50 - 60 cm	1,60 Kg
69576	220-240 V; 50/60 Hz	275 W	50 - 60 cm	1,60 Kg

# CALENTADORAS

## Ollas



### ES

- Mantiene caliente todo tipo de sopas, salsas, consomés y líquidos.
- Ideal para cantidades grandes.
- Control de temperatura regulable por termostato.
- Cubeta interior desmontable.
- Alta resistencia y durabilidad.

### FR

- Maintenir au chaud tout type de soupes, sauces, consommés, liquides, etc.
- Idéal pour de grandes quantités.
- Contrôle de la température réglable par thermostat.
- Seau intérieur amovible.
- Haute résistance et durabilité.

### EN

- Keep all kinds of soups, sauces, consommés, liquids etc hot.
- Ideal for large amounts.
- Temperature control adjustable by thermostat.
- Removable inner bucket.
- High resistance and durability.

**A**  
Inox 18/10



**Capacidad: 10 L / Medidas: Ø24x25 cm**  
Repuesto para las ref.: 69037-69038  
Capacity: 10 l / Sizes: Ø24x25 cm  
Replacement for ref.: 69037-69038

**D**  
Inox 18/10



### Olla calentador sopa PROFESIONAL

Marmite Buffet chaud · Suppen- und Speisenwärmer  
Soup kettle · Panela aquecedora de sopa

Ref	€	U.Venta	
<b>A</b> 69267	289,90	1	<b>Inox 18/10</b> · 18/10 stainless steel
<b>B</b> 69037	173,90	1	<b>Hierro esmaltado</b> · Enameled iron
<b>C</b> 69038	245,20	1	<b>Inox</b> · St steel
<b>D</b> 69039	58,10	1	<b>Repuesto</b> · Replacement (69037-69038)

Ref	Tensión/Voltage	Potencia/Power	Temperatura/Temp.	Capacidad/Capacity	Dimensiones/Sizes	Peso/Weight
69267	220-240 V; 50/60 Hz	800 W	30°C - 90°C	11,0 L	Ø33x32 cm	4,50 Kg
69037	220-240 V; 50/60 Hz	400 - 475 W	30°C - 90°C	10,0 L	Ø34,5x36 cm	4,50 Kg
69038	220-240 V; 50/60 Hz	400 - 475 W	30°C - 90°C	10,0 L	Ø34,5x36 cm	4,50 Kg

# VITRINAS

## Colección



**Parte trasera. Puertas traseras abatibles**  
Back side. Hinged rear doors



**Vitrina neutra**  
Vitrine neutre · Einfache vitrine  
Clear countertop display case · Vitrina neutra

Ref	€	cm	h (cm)	L	U.Venta
69601	285,30	55,4x37,6	37	45	1

- Vitrina neutra construida integramente en cristal y base de acero inoxidable.
- Diseñada para presentar y exponer sobre la barra / mostrador.
- Superficie superior curvada para una visión panorámica.
- Estante intermedio de cristal templado.
- Puerta trasera abatible.
- 4 pies de goma que garantizan máxima estabilidad.

- Vitrine neutre intégralement fabriquée en verre et base en acier inoxydable.
- Conçue pour présenter et exposer sur le plan de travail / comptoir.
- Surface supérieure courbée pour une vision panoramique.
- Étagère intermédiaire en verre trempé.
- Porte arrière rabattable.
- 4 pieds en caoutchouc qui garantissent une qualité maximale.

- Clear countertop display case made entirely of glass, including a stainless steel base.
- Designed for presenting and displaying food on the bar/countertop.
- Full view curved upper surface.
- Middle shelf made of tempered glass.
- Hinged rear door.
- 4 rubber feet for maximum stability.

**B**



**C**



**Rejilla extraíble, facilita el flujo del calor**  
Removable racks for better heat flow



**Parte trasera. Puertas traseras abatibles**  
Back side. Hinged rear doors



**Vitrina térmica**  
Vitrine thermique · Warmhaltevitrine  
Thermal display case · Vitrina térmica

Ref	€	W	L	U.Venta
69604	577,00	800	45	1

- Vitrina térmica fabricada en acero inoxidable y cristal.
- Diseñada para conservar, presentar y exponer sobre la barra / mostrador.
- Puerta trasera abatible.
- Superficie superior inclinada para una visión panorámica.
- Recipiente de agua extraíble que aporta humedad en la cámara.
- Termostato de control de temperatura regulable: 30-90°C.
- Bandeja de rejilla extraíble que facilita el flujo del calor.

- Vitrine thermique fabriquée en acier inoxydable et verre.
- Conçue pour conserver, présenter et exposer sur le plan de travail / comptoir.
- Porte arrière rabattable.
- Surface supérieure inclinée pour une vision panoramique.
- Récipient d'eau extractible qui apporte de l'humidité à la chambre.
- Thermostat de contrôle pour régler la température : 30-90°C.
- Plateau grillagé extractible qui facilite le flux de chaleur.

- Thermal display case made of stainless steel and glass.
- Designed for storing, presenting and displaying food on the bar/countertop.
- Hinged rear door.
- Full view curved upper surface.
- Removable water tray to keep the chamber moist.
- Adjustable temperature control thermostat: 30-90°C.
- Removable racks for better heat flow.

Ref	Tensión/Voltage	Pot./Power	Capacidad/Capacity	Temp./Temp.	Protec./Protection	Parrilla/Grill	Parrilla/Grill (h)	Dimensiones/Sizes	Peso/Weight
69604	220-240 V; 50 Hz	800	45	30°C - 90°C	IPX4	52,5x28,5 cm	8,5 cm / 10 cm	55,4x37,6x37,6 cm	14,4 Kg



**Parte trasera.**  
Puertas traseras  
correderas.  
4 / 6 cubetas gastro-  
norm 1/3 incluidas  
Back side.  
Sliding rear doors.  
4/6 Gastronorm 1/3  
trays included

IPX4



4  
Cubetas  
Containers



6  
Cubetas  
Containers

### Vitrina Térmica

Vitrine thermique · Warmhaltevitrine  
Thermal display case · Vitrina térmica

Ref	€	W	Capacidad	U.Venta
A 69602	636,20	500	4xGN1/3	1
B 69603	731,40	800	6xGN1/3	1

- Vitrina térmica fabricada en acero inoxidable y cristal.
  - Diseñada para conservar, presentar y exponer sobre la barra / mostrador.
  - Puertas correderas para una accesibilidad total.
  - Superficie superior curvada para una visión panorámica.
  - 4 / 6 cubetas gastronorm 1/3 incluidas.
  - Termostato de control de temperatura regulable: 30 - 90°C.
- Vitrine thermique fabriquée en acier inoxydable et verre.
  - Conçue pour conserver, présenter et exposer sur le plan de travail / comptoir.
  - Portes coulissantes pour une accessibilité totale.
  - Surface supérieure courbée pour une vision panoramique.
  - 4 / 6 bacs gastronorm 1/3 inclus.
  - Thermostat de contrôle pour régler la température : 30 - 90°C.
- Thermal display case made of stainless steel and glass.
  - Designed for storing, presenting and displaying food on the bar/countertop.
  - Sliding doors for easy access.
  - Full view curved upper surface.
  - 4/6 Gastronorm 1/3 trays included.
  - Adjustable temperature control thermostat: 30 - 90°C.

69602 Combinaciones posibles Possible combinations				69603 Combinaciones posibles Possible combinations			
GN 2/3	GN 2/3	GN 2/3	GN 2/3	GN 2/3	GN 2/3	GN 2/3	GN 2/3
GN 1/3	GN 1/3	GN 1/3	GN 1/3	GN 1/2	GN 1/2	GN 1/2	GN 1/2
GN 1/3	GN 1/3	GN 1/3	GN 1/3	GN 1/3	GN 1/3	GN 1/3	GN 1/3



**Control de temperatura regulable**  
Temperature control thermostat



**Tubo desagüe con tapón**  
Drain tube with cap

**Puertas traseras correderas**  
Sliding rear doors



4  
Cubetas  
Containers



6  
Cubetas  
Containers



### Vitrina refrigerada

Vitrine réfrigérée · Kühlvitrine  
Refrigerated display case · Vitrina refrigerada

Ref	€	W	Capacidad	U.Venta
A 69605	1.236,70	160	4xGN1/3	1
B 69606	1.371,10	160	6xGN1/3	1

Ref	Tensión/Voltage	Potencia/Power	Capacidad/Capacity	Temperatura/Temp.	Refrigerante/Refrig.	Dimensiones/Sizes	Peso/Weight
69605	220-240 V; 50Hz	160 W	4 x GN 1/3	0°C - 12°C	R600a	112,1x45x33 cm	33 Kg
69606	220-240 V; 50 Hz	160 W	6 x GN 1/3	0°C - 12°C	R600a	148,3x45x33 cm	39 Kg

- Vitrina refrigerada construida íntegramente en cristal y acero inoxidable.
- Diseñada para conservar, presentar y exponer sobre la barra / mostrador.
- Puertas correderas para una accesibilidad total.
- Superficie superior curvada para una visión panorámica.
- Sistema de enfriamiento por compresor.
- 4 / 6 cubetas gastronorm 1/3 incluidas.
- Termostato de control de temperatura regulable: 0-12°C.
- Sistema de iluminación LED en la cámara interior y display de control de mandos.

- Vitrine réfrigérée intégralement fabriquée en verre et acier inoxydable.
- Conçue pour conserver, présenter et exposer sur le plan de travail / comptoir.
- Portes coulissantes pour une accessibilité totale.
- Surface supérieure courbée pour une vision panoramique.
- Système de refroidissement par compresseur.
- 4 / 6 bacs gastronorm 1/3 inclus.
- Thermostat de contrôle pour régler la température : 0-12°C.
- Système d'éclairage LED dans la chambre intérieure et écran de contrôle de commandes.

- Refrigerated display case made entirely of glass, including a stainless steel base.
- Designed for storing, presenting and displaying food on the bar/countertop.
- Sliding doors for easy access.
- Full view curved upper surface.
- Compressor cooling system.
- 4/6 Gastronorm 1/3 trays included.
- Adjustable temperature control thermostat: 0-12°C.
- LED lighting for inner chamber illumination and control display unit.

**Parte trasera**  
Back side



### Vitrina refrigerada

Vitrine réfrigérée · Kühlvitrine  
Refrigerated display case · Vitrina refrigerada

Ref	€	W	L	U.Venta
69607	1.084,00	105	40	1

- Vitrina refrigerada construida íntegramente en cristal y acero inoxidable.
- Diseñada para conservar, presentar y exponer sobre la barra / mostrador.
- Puertas correderas para una accesibilidad total.
- Superficie superior inclinada para una visión panorámica.
- Sistema de enfriamiento por compresor. Función Defrost.
- Termostato de control de temperatura regulable: 2-12°C.
- Sist. de iluminación LED en la cámara interior y display de control de mandos.

- Vitrine réfrigérée intégralement fabriquée en verre et acier inoxydable.
- Conçue pour conserver, présenter et exposer sur le plan de travail / comptoir.
- Portes coulissantes pour une accessibilité totale.
- Surface supérieure courbée pour une vision panoramique.
- Système de refroidissement par compresseur.
- Thermostat de contrôle pour régler la température : 0-12°C.
- Syst. d'éclairage LED dans la chambre intérieure et écran de contrôle de commandes.

- Refrigerated display case made entirely of glass, including a st. steel base.
- Designed for storing, presenting and displaying food on the bar/countertop.
- Sliding doors for easy access.
- Full view curved upper surface.
- Compressor cooling system. Defrost function.
- Adjustable temperature control thermostat: 2-12°C.
- LED lighting for inner chamber illumination and control display unit.

Ref	Tensión/Voltage	Potencia/Power	Capacidad/Capacity	Temperatura/Temp.	Refrigerante/Refr.	Dimensiones/Sizes	Peso/Weight
69607	220-240 V; 50Hz	105 W	40	2°C - 12°C	R600a	68x57,5x33,5 cm	25 Kg

06

Gastronorm  
Gastronorm

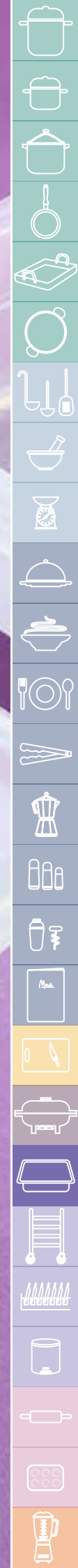

# CUBETAS

## Soportes

Inox  
18/10



Diversas combinaciones posibles  
Several possible combinations

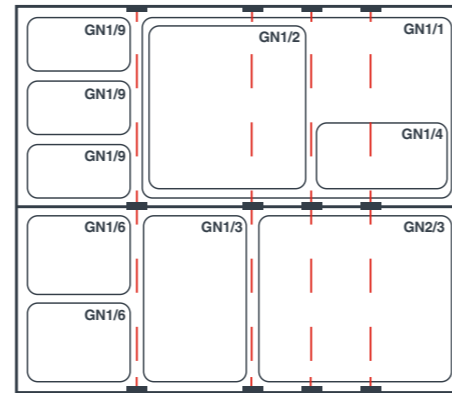

Cubetas GN no incluidas  
Bacs GN non inclus



### ES

- Fabricado en acero inoxidable 18/10.
- Organiza los alimentos y ahorra tiempo en la preparación de platos.
- Ideal para cocinas profesionales, restaurantes, buffet, autoservicios, etc.
- Travesaños verticales amovibles diseñados para combinar cubetas de distintos tamaños de hasta 200 mm de profundidad.
- Pies de goma antideslizantes que garantizan una óptima estabilidad.

### FR

- Fabriqué en acier inoxydable 18/10.
- Organisez les aliments et gagnez du temps lors de la préparation de vos plats.
- Idéal pour les cuisines professionnelles, les restaurants, les buffets, les self-services, etc.
- Barres transversales verticales amovibles conçues pour combiner des bacs de différentes tailles de 200 mm de profondeur.
- Pieds en caoutchouc antidérapants qui garantissent une stabilité optimale.

### EN

- Made of 18/10 stainless steel.
- Organize food and save time while making dishes.
- Perfect for professional chefs, restaurants, buffets, self-service, etc.
- It has removable vertical cross pieces designed to combine trays of different sizes to 200 mm deep.
- The non-slip rubber feet ensure optimum stability.



Soporte para cubetas Gastronorm

Support de bacs Gastronorm · Unterstützung für Gastronorm-Küvetten  
Gastronorm cuvette support · Suporte de cubeta Gastronorm

	Ref	€	cm	Cubeta (cm)	U.Venta	
A	66245	81,90	78x49x46	34x26,5x2	1	<b>Soporte simple</b> · Simple support
B	66246	105,40	78x78x63	34x26,5x2	1	<b>Soporte doble</b> · Double support

## COMPATIBILIDAD DE CUBETAS CON LOS SOPORTES CONTAINERS COMPATIBILITY WITH SUPPORTS

	INOX 18/10	INOX	PC	PP	MELAMINA
<p>GN 2/1 530 mm x 650 mm</p>	X	X			
<p>GN 1/1 530 mm x 325 mm</p>	✓	✓	✓	X	✓
<p>GN 2/3 354 mm x 325 mm</p>	✓	✓	✓		✓
<p>GN 2/4 530 mm x 165 mm</p>	X	X			X
<p>GN 1/2 265 mm x 325 mm</p>	✓	✓	✓	X	✓
<p>GN 1/3 176 mm x 325 mm</p>	✓	✓	✓	✓	✓
<p>GN 1/4 265 mm x 162 mm</p>	X	X	✓	X	X
<p>GN 1/6 176 mm x 162 mm</p>	✓	✓	✓	✓	✓
<p>GN 1/9 176 mm x 108 mm</p>	✓	✓	✓	✓	



# INOX 18/10 · INOX

## Cubetas

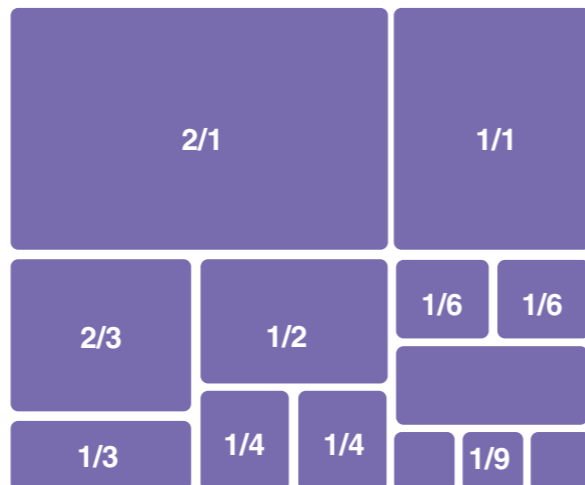

### ES

- Fabricadas en acero inoxidable y acero inoxidable 18/10.
- Apilables.
- Aptas para procesos de refrigeración, congelación, hornos microondas o distribución de alimentos.
- Higiénicos y fácilmente lavables, aptas para el lavavajillas.

### FR

- Fabriquées en acier inoxydable et en acier inoxydable 18/10.
- Empilables.
- Compatibles pour des processus de réfrigération, congélation, fours à micro-ondes ou distribution d'aliments.
- Hygiéniques et facilement lavables, compatible lave-vaisselle.

### EN

- Manufactured in stainless steel and stainless steel 18/10.
- Stackable.
- Suitable for refrigeration and freezing processes, microwave ovens or food distribution.
- Hygienic and easily washable, dishwasher safe.

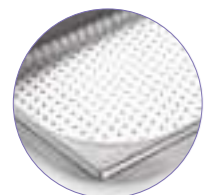

Ø del agujero perforado: Ø4 mm  
Drilled hole Ø: Ø4 mm

2/1  
530 x 650 mm



### Cubeta 2/1

Bac 2/1 · GN-Behälter 2/1  
Container 2/1 · Caixa 2/1

Inox 18/10	€	Inox	€	h (mm)	L	U.Venta	
66002	47,30	66002Z	42,00	20	6,50	1	Bandeja
66040	52,30	66040Z	47,40	40	11,00	1	Bandeja
66065	59,60	66065Z	49,90	65	18,90	1	Bandeja
66010	72,80	66010Z	61,00	100	31,50	1	
66015	88,00	66015Z	76,70	150	44,90	1	
66020	114,40	66020Z	102,40	200	60,00	1	

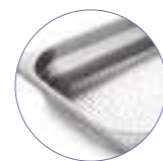

### Cubeta perforada 2/1

Bac perfore 2/1 · GN-Behälter, perforiert, 2/1  
Perforated container 2/1 · Caixa perforada 2/1

Inox 18/10	€	Inox	€	h (mm)	U.Venta	
-	-	-	-	-	-	-
66042	64,10	-	-	40	1	NO perf. lateral
66067	80,70	66067Z	56,60	65	1	NO perf. lateral
66012	99,40	66012Z	69,70	100	1	NO perf. lateral
66017	148,80	-	-	150	1	NO perf. lateral

1/1  
530 x 325 mm



### Cubeta 1/1

Bac 1/1 · GN-Behälter 1/1  
Container 1/1 · Caixa 1/1

Inox 18/10	€	Inox	€	h (mm)	L	U.Venta	
66102	23,40	66102Z	19,80	20	3,00	1	Bandeja
66140	24,50	66140Z	21,20	40	5,50	1	Bandeja
66155	27,50	66155Z	22,40	55	7,20	1	Bandeja
66165	29,60	66165Z	23,20	65	8,50	1	Bandeja
66110	42,10	66110Z	31,50	100	13,30	1	
66115	50,00	66115Z	43,30	150	20,60	1	
66120	59,00	66120Z	52,50	200	30,00	1	

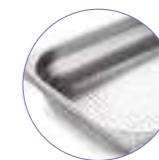

### Cubeta perforada 1/1

Bac perfore 1/1 · GN-Behälter, perforiert, 1/1  
Perforated container 1/1 · Caixa perforada 1/1

Inox 18/10	€	Inox	€	h (mm)	U.Venta	
66104	35,30	-	-	20	1	NO perf. lateral
66142	41,90	66142Z	23,60	40	1	
-	-	-	-	-	-	-
66167	46,30	66167Z	25,50	65	1	
66112	59,60	66112Z	35,70	100	1	
66117	88,40	66117Z	57,60	150	1	
66122	101,40	66122Z	69,90	200	1	

2/3  
354 x 325 mm



### Cubeta 2/3

Bac 2/3 · GN-Behälter 2/3  
Container 2/3 · Caixa 2/3

Inox 18/10	€	Inox	€	h (mm)	L	U.Venta	
66502	20,30	66502Z	16,70	20	1,70	1	Bandeja
66540	25,60	66540Z	21,70	40	3,50	1	Bandeja
66565	29,30	66565Z	24,50	65	5,50	1	Bandeja
66510	36,40	66510Z	30,50	100	8,90	1	
66515	50,90	66515Z	42,50	150	13,60	1	
66520	67,70	66520Z	56,70	200	19,30	1	

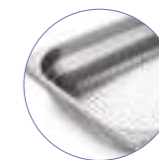

### Cubeta perforada 2/3

Bac perfore 2/3 · GN-Behälter, perforiert, 2/3  
Perforated container 2/3 · Caixa perforada 2/3

Inox 18/10	€	Inox	€	h (mm)	U.Venta	
-	-	-	-	-	-	-
-	-	-	-	-	-	-
-	-	66567Z	21,90	65	-	
-	-	66512Z	31,30	100	1	
-	-	66517Z	42,50	150	1	

1/2  
265 x 325 mm



### Cubeta 1/2

Bac 1/2 · GN-Behälter 1/2  
Container 1/2 · Caixa 1/2

Inox 18/10	€	Inox	€	h (mm)	L	U.Venta	
66202	15,80	66202Z	11,10	20	1,20	1	Bandeja
66240	16,60	66240Z	11,50	40	2,50	1	Bandeja
-	-	66255Z	12,90	55	3,20	1	Bandeja
66265	18,90	66265Z	13,40	65	4,20	1	Bandeja
66210	27,50	66210Z	18,90	100	8,00	1	
66215	35,30	66215Z	27,20	150	9,90	1	
66220	45,10	66220Z	33,60	200	11,60	1	

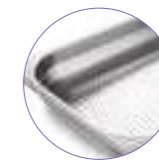

### Cubeta perforada 1/2

Bac perfore 1/2 · GN-Behälter, perforiert, 1/2  
Perforated container 1/2 · Caixa perforada 1/2

Inox 18/10	€	Inox	€	h (mm)	U.Venta	
-	-	-	-	-	-	-
66242	29,70	-	-	40	1	NO perf. lateral
-	-	-	-	-	-	-
66267	34,10	-	-	65	1	
66212	41,80	-	-	100	1	
66217	56,60	-	-	150	1	
66222	78,60	-	-	200	1	

2/4  
530 x 165 mm



### Cubeta 2/4

Bac 2/4 · GN-Behälter 2/4  
Container 2/4 · Caixa 2/4

Inox 18/10	€	Inox	€	h (mm)	L	U.Venta
67604	22,10	67604Z	18,40	40	1,80	1
67665	25,10	67665Z	20,60	65	4,50	1
67610	31,10	67610Z	25,60	100	5,50	1
67615	47,00	67615Z	38,50	150	8,50	1

1/4  
265 x 162 mm



### Cubeta 1/4

Bac 1/4 · GN-Behälter 1/4  
Container 1/4 · Caixa 1/4

Inox 18/10	€	Inox	€	h (mm)	L	U.Venta
66402	11,10	66402Z	7,60	20	0,60	6
66465	12,40	66465Z	8,40	65	1,90	6
66410	18,50	66410Z	13,00	100	2,50	1
66415	25,40	66415Z	17,40	150	4,10	1
66420	34,60	66420Z	21,00	200	4,90	1

1/9  
176 x 108 mm



### Cubeta 1/9

Bac 1/9 · GN-Behälter 1/9  
Container 1/9 · Caixa 1/9

Inox 18/10	€	Inox	€	h (mm)	L	U.Venta
66965	8,70	66965Z	5,00	65	0,70	6
66910	15,10	66910Z	7,90	100	0,85	6



### Doble fondo perforado

Double fond perforé · Doppel-Boden gelocht  
Punched double bottom perf. · Duplo fundo perforado

Inox 18/10	€	Inox	€	Cubeta
66909	109,50	-	-	2/1
66911	34,90	66911Z	23,20	1/1
66912	23,80	66912Z	15,70	1/2

1/3  
176 x 325 mm



### Cubeta 1/3

Bac 1/3 · GN-Behälter 1/3  
Container 1/3 · Caixa 1/3

Inox 18/10	€	Inox	€	h (mm)	L	U.Venta
66302	14,80	66302Z	8,40	20	0,80	6
66340	14,90	66340Z	9,20	40	1,60	6
66355	15,40	66355Z	9,50	55	2,00	6
66365	15,60	66365Z	9,70	65	2,50	6
66310	22,30	66310Z	15,40	100	3,80	1
66315	32,60	66315Z	20,60	150	5,90	1
66320	37,40	66320Z	24,40	200	8,10	1

1/6  
176 x 162 mm



### Cubeta 1/6

Bac 1/6 · GN-Behälter 1/6  
Container 1/6 · Caixa 1/6

Inox 18/10	€	Inox	€	h (mm)	L	U.Venta
66665	10,10	66665Z	6,80	65	1,10	6
66610	16,10	66610Z	10,40	100	1,60	6
66615	25,20	66615Z	14,40	150	2,50	1
66620	31,60	66620Z	17,00	200	3,30	1



### Guia divisora

Guide de division · GN Zwischensteg  
Splitting guides · Guia divisória

Inox 18/10	€	Inox	€	L (mm)	U.Venta
66923	14,40	66923Z	6,00	530	1
66925	10,70	66925Z	3,90	325	1



### Tapa para cubeta

Couvercle pour bac · GN Deckel  
Container lid · Tamba para caixa

Inox 18/10	€	Inox	€	Cubeta	U.Venta
-	-	66908DZ	38,20	2/1	1
66901D	26,30	66901DZ	18,20	1/1	1
66905D	20,90	66905DZ	12,50	2/3	1
66907	16,80	-	-	2/4	1
66902D	13,90	66902DZ	8,90	1/2	6
66903D	11,10	66903DZ	6,90	1/3	6
66904D	9,40	66904DZ	6,40	1/4	6
66906D	7,10	66906DZ	3,70	1/6	6
66909D	6,60	66909DZ	2,80	1/9	6



### Tapa para cubeta

Couvercle pour bac · GN Deckel  
Container lid · Tamba para caixa

Inox 18/10	€	Inox	€	Cubeta	U.Venta
67901	26,20	67901Z	18,30	1/1	1
67905	16,00	67905Z	11,10	2/3	1
67902	14,30	67902Z	9,90	1/2	6
67903	10,40	67903Z	7,10	1/3	6
67904	8,70	67904Z	6,00	1/4	6
67906	7,10	67906Z	5,00	1/6	6
67909	6,00	67909Z	4,20	1/9	6

Inox

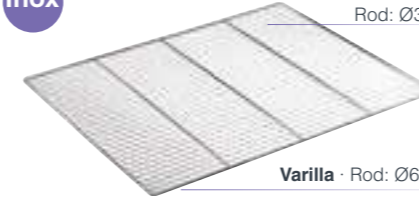

Varilla  
Rod: Ø3 mm

Varilla · Rod: Ø6 mm

### Parrilla

Grille · GN Drahtgitter  
Grill · Grelha

Ref	€	cm	Cubeta	U.Venta
66920	53,60	65x53	2/1	1
66921	20,60	53x32,5	1/1	1



### Pinza para horno/bandeja GN

Pince inox pour bac GN · Zange für GN Behälter  
Tong GN tray · Pinça para forno e bandejas GN

Ref	€	L (cm)	U.Venta
62989	17,00	20	12

Bandeja



Si 200 °C  
Silicone

### Pinza para horno/bandeja GN

Pince inox pour bac GN · Zange für GN Behälter  
Tong GN tray · Pinça para forno e bandejas GN

Ref	€	L (cm)	U.Venta
62998	17,00	20	12

# HELADO Cubetas

Inox 18/10 Stackable Dishwasher

- Cubetas fabricadas en acero inoxidable 18/10.
- Diseñados para conservar el helado.
- Bordes perfilados para un agarre óptimo y funcional.
- Tapa fabricada en policarbonato; color transparente.
- Forma de cúpula para una mayor capacidad del helado.

- Bacs fabriqués en acier inoxydable de la plus grande qualité.
- Conçus pour conserver la glace.
- Bords profilés pour une prise en main optimale et fonctionnelle.
- Couvercle transparent fabriqué en polycarbonate.
- Forme de coupole pour une plus grande capacité de glace.

- Top quality stainless steel pans.
- Designed for storing ice cream.
- Shaped edges for optimal and functional handling.
- Polycarbonate lid, transparent colour.
- Dome shaped for greater ice cream capacity.

- Fabricados en policarbonato, color transparente.
- Diseñados para conservar el helado.
- Bordes perfilados para un agarre óptimo y funcional.
- Tapa fabricada en policarbonato; color transparente.
- Tapa con asa para fácil manejo.

- Made of polycarbonate, transparent colour.
- Designed for storing ice cream.
- Shaped edges for optimal and functional handling.
- Polycarbonate lid, transparent colour.
- Lid with handle for easy handling.

## New

- A- Compatible con tapas (66900P/66908P)**  
Compatible with lids (66900P/66908P)
- B- Compatible con cubetas (66175/66172P)**  
Compatible with containers (669175/66172P)

PC polycarbonate



### Cubeta para helado

Bac à glace · Eiskübel  
Ice cream container · Caixa de sorvete

Ref	€	cm	h (cm)	L	U.Venta
66178	27,10	36x16,5	8,0	3,8	1
66172	27,20	36x16,5	12,0	5,0	1
66175	34,30	36x16,5	15,0	6,5	1
66900P	9,60	36x16,5	7,6	-	1

Tapa · Lid



### Cubeta para helado

Bac à glace · Eiskübel  
Ice cream container · Caixa de sorvete

Ref.	€	cm	h (cm)	L	U.Venta
66172P	9,60	36x16,5	12,0	5,0	6
66908P	6,60	36x16,5	2,0	-	6



# MELAMINA

## Cubetas



### ES

- Fabricadas en melamina de alta calidad.
- Libres de BPA.
- Ligeras, indeformables y apilables.
- Higiénicas y fácilmente lavables.
- Aptas para procesos de refrigeración, congelación o distribución de alimentos.

### FR

- Fabriqué en mélamine de haute qualité.
- Sans BPA.
- Légères, indéformables et empilables.
- Hygiéniques et facilement lavables.
- Compatibles pour des processus de réfrigération, congélation ou distribution d'aliments.

### EN

- Made of high quality melamine.
- BPA free.
- Light, non-deformable and stackable.
- Hygienic and easily washable.
- Suitable for refrigeration and freezing processes and food distribution

1/1  
530 x 325 mm



#### Cubeta 1/1

Bac 1/1 · GN-Behälter 1/1  
Container 1/1 · Caixa 1/1

	Ref	€	h (mm)	L	U.Venta
A	66165E	44,20	65	8,50	1
A	66110E	50,30	100	13,30	1
B	66165J	47,00	65	8,50	1
B	66110J	52,90	100	13,30	1

1/2  
265 x 325 mm



#### Cubeta 1/2

Bac 1/2 · GN-Behälter 1/2  
Container 1/2 · Caixa 1/2

	Ref	€	h (mm)	L	U.Venta
A	66265E	23,10	65	4,50	1
A	66210E	25,60	100	8,00	1
B	66265J	24,10	65	4,50	1
B	66210J	27,20	100	8,00	1

1/3  
176 x 325 mm



#### Cubeta 1/3

Bac 1/3 · GN-Behälter 1/3  
Container 1/3 · Caixa 1/3

	Ref	€	h (mm)	L	U.Venta
A	66365E	18,00	65	2,50	1
A	66310E	20,00	100	3,80	1
B	66365J	19,30	65	2,50	1
B	66310J	21,40	100	3,80	1

1/4  
265 x 162 mm



#### Cubeta 1/4

Bac 1/4 · GN-Behälter 1/4  
Container 1/4 · Caixa 1/4

	Ref	€	h (mm)	L	U.Venta
A	66465E	15,50	65	1,90	1
A	66410E	17,40	100	2,50	1
B	66465J	16,50	65	1,90	1
B	66410J	18,60	100	2,50	1

2/3  
350 x 325 mm



#### Cubeta 2/3

Bac 2/3 · GN-Behälter 2/3  
Container 2/3 · Caixa 2/3

	Ref	€	h (mm)	L	U.Venta
A	66565E	33,30	65	5,50	1
B	66565J	34,80	65	5,50	1

1/6  
176 x 162 mm



#### Cubeta 1/6

Bac 1/6 · GN-Behälter 1/6  
Container 1/6 · Caixa 1/6

	Ref	€	h (mm)	L	U.Venta
A	66665E	11,10	65	1,10	1
A	66610E	12,40	100	1,60	1
B	66665J	11,80	65	1,10	1
B	66610J	13,30	100	1,60	1

2/4  
530 x 165 mm



#### Cubeta 2/4

Bac 2/4 · GN-Behälter 2/4  
Container 2/4 · Caixa 2/4

	Ref	€	h (mm)	L	U.Venta
A	66765E	23,20	65	4,50	1
B	66765J	24,00	65	4,50	1

# ISOTÉRMICOS

## Contenedores

EPP  
Expanded  
Polypropilene



New

ES

- Fabricados en EPP. Permiten la conservación del frío y el calor: ideales para mantener la temperatura de los alimentos almacenados en el interior.
- Superficie impermeable.
- Totalmente plegables para ahorrar espacio.
- Asas en los laterales para facilitar la movilidad.
- 66064: Capacidad de 18 litros. Medidas: montada: 38x38x22 cm / plegada: 38x38x11 cm / interiores: 33,5x33,5x16 cm.
- 66066: Capacidad de 38,5 litros. Medidas: montada: 60x40x25 cm / plegada: 60x40x11 cm / interiores: 55x35x20 cm.

FR

- Fabriquée en PPE. Permet la conservation du froid et de la chaleur: idéale pour maintenir la température des aliments se trouvant à l'intérieur.
- Surface imperméable.
- Entièrement pliable pour un gain de place.
- Poignées latérales pour faciliter le transport.
- 66064: Capacité de 18 litres. Mesures: montée: 38x38x22 cm / pliée: 38x38x11 cm / intérieurs: 33,5x33,5x16 cm.
- 66066: Capacité de 38,5 litres. Mesures: montée: 60x40x25 cm / pliée: 60x40x11 cm / intérieurs: 55x35x20 cm.

EN

- Made of EPP. Retains both heat and cold: ideal for maintaining the temperature of food stored inside.
- Impermeable surface.
- Totally foldable to save space
- Handles on the sides for easy mobility.
- 66064: 18 litres capacity. Sizes: assembled: 38x38x22 cm / folded: 38x38x11 cm / interiors: 33,5x33,5x16 cm.
- 66066: 38,5 litres capacity. Sizes: assembled: 60x40x25 cm / folded: 60x40x11 cm / interiors: 55x35x20 cm.

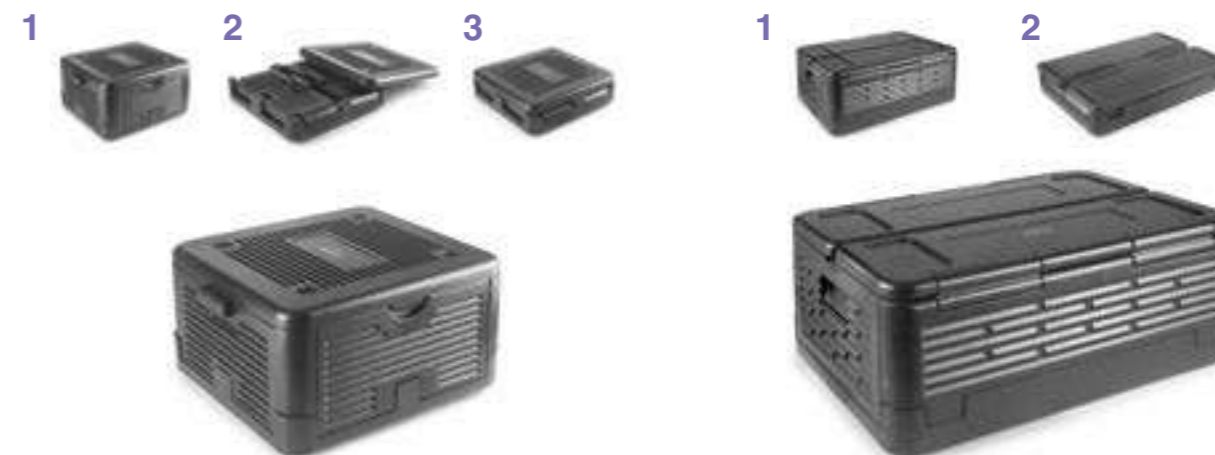

**Caja isotérmica TEMPLE**  
PBoîte isotherme · Isothermische Box  
Isothermal box · Caixa isotérmica

	Ref.	€	cm	h (cm)	L	U.Venta
A	66064	21,70	38x38	22	18,0	1
B	66066	37,20	60x40	25	38,5	1

Transporte - Estanterías  
Transport - Shelves

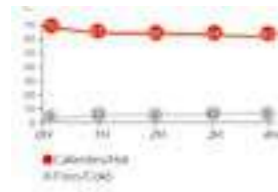

- Diseñado para el transporte de cubetas.
  - Contenedor isotérmico rígido, ligero, robusto y apilable.
  - Puerta sin bisagra, sistema de cierre en la tapa.
  - Ideal para transporte de alimentos en catering o cocinas.
- Conçu pour le transport de bacs.
  - Conteneur isotherme rigide, léger, robuste et empilable.
  - Porte sans charnière, système de verrouillage sur le couvercle.
  - Idéal pour le transport des aliments de restauration ou de cuisson.
- Designed for transporting containers.
  - Isothermal container rigid, lightweight, sturdy and stackable.
  - Door without hinge, locking system on the lid.
  - Ideal for transporting food catering or cooking.



1xGN 1/1 - 100  
1xGN 2/3 - 100  
1xGN1/3 - 100

2xGN 1/2 - 200  
3xGN 1/3 - 200  
4xGN 1/4 - 200

12xGN 1/1 - 20  
6xGN 1/1 - 65  
4xGN 1/1 - 100  
3xGN 1/1 - 150  
2xGN 1/1 - 200

### Thermotrans

Thermotrans · Thermotrans  
Thermotrans · Thermotrans

Ref	€	cm	U.Venta
A 66099	606,10	41x62x24	1
B 66299	649,00	41x62x37	1
C 66599	801,80	41x62x57,5	1

## CARROS Colección



Tubo AISI 304 Ø25 mm. Espesor chapa 1,6 mm  
Tube AISI 304 Ø 25 mm. Sheet thickness 1.6 mm



Entrega desmontado  
Dismantled delivery

### Carro servicio

Chariot de service · Servierwagen  
Service trolley · Carro serviço

Ref	€	cm	U.Venta
66249	185,70	82x64,5x94,5	1



Entrega desmontado  
Dismantled delivery

### Carro servicio

Chariot de service · Servierwagen  
Service trolley · Carro serviço

Ref	€	cm	U.Venta
66349	240,50	82x64,5x94,5	1



Entrega montado  
Mounted delivery

### Carro servicio soldado

Chariot de service · Servierwagen  
Service trolley · Carro serviço soldado

Ref	€	cm	U.Venta
66350	706,70	82x64,5x94,5	1



Pestillo de bloqueo  
Locking tab

Fácil de plegar  
Easy to fold

### Carro de servicio plegable

Chariot de servie pliable · Faltbarer servierwagen  
Folding service cart · Carro de serviço dobrável

Ref	€	cm	Balda	U.Venta
66247	433,80	93x51x93,5	30 kg	1



Entrega desmontado  
Dismantled delivery

### Carro servicio

Chariot de service · Servierwagen  
Service trolley · Carro serviço

Ref	€	cm	U.Venta
66353	264,20	103x49x95	1

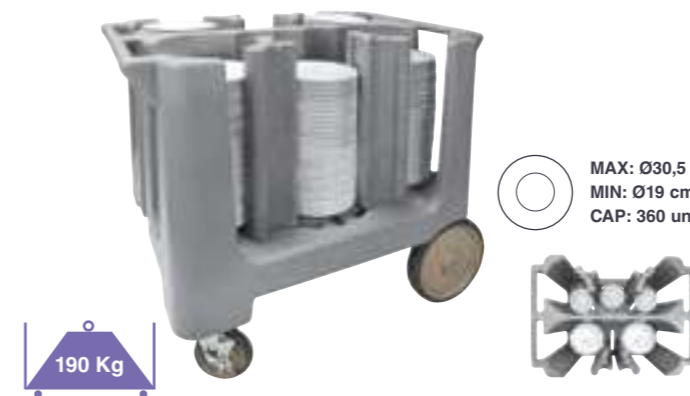

### Carro portaplatos

Chariot porte-plateau · Tellerwagen  
Dish cart · Carro porta-pratos

Ref	€	cm	h (cm)	U.Venta
66555	1.340,10	96x71	81,0	1

- Elegante diseño, perfecto para restaurantes, bares, cocinas, etc.
- Ideal para uso en interiores como exteriores.
- Construido con materiales resistentes y ligeros.
- Asas en ambos lados para facilitar su manejo.
- Ruedas giratorias multidireccionales que facilitan la movilidad en cualquier superficie.
- Dos ruedas con freno de bloqueo para mayor seguridad.
- Tres estantes que soportan 30 kg cada uno.
- Se pliega por la mitad para facilitar su almacenaje.
- Dispone de pestillo de bloqueo para mantener el carro en la posición plegada.

- Style élégant, parfait pour les restaurants, bars, cuisines, etc.
- Idéal pour une utilisation aussi bien en intérieur qu'en extérieur.
- Fabriqué avec des matériaux résistants et légers.
- Poignées des deux côtés pour faciliter sa manipulation.
- Roues pivotantes multidirectionnelles qui facilitent la mobilité sur tout type de surface.
- Deux roues avec frein de blocage pour une plus grande sécurité.
- Trois étagères qui supportent 30 kg chacune.
- Se plie en deux pour faciliter son rangement.
- Dispose d'une languette de blocage pour maintenir le chariot en position pliée.

- It has an elegant design that is perfect for restaurants, bars or kitchens, etc.
- It's perfect for indoor or outdoor use.
- It's built with strong and lightweight materials.
- It has handles on both sides for easy carrying.
- The multi-directional rotating wheels make it easy to move on any surface.
- It has two wheels with a brake for greater safety.
- It has three shelves that can hold 30 kg each.
- It folds in half for easy storage.
- It has a locking tab to keep the cart in a folded position.

### Contenedor cubiertos plástico

Bac plastique pour couverts · Besteckebehälter aus Plastik  
Cuttlery plastic bin · Recipiente de talheres plástico

Ref	€	cm	U.Venta
66351	39,00	33x23x18	1

### Contenedor desperdicios plástico

Bac à déchets plastique · Müllbehälter aus Plastik  
Rubbish plastic bin · Recipiente de desperdícios em plástico

Ref	€	cm	U.Venta
66352	65,10	33x284x56	1



### Funda carro portaplatos

Housse chariot porte-plateau · Abdeckung für tellerwagen  
Dish cart cover · Capa protectora carro porta-pratos

Ref	€	cm	U.Venta
62964	47,80	96x71x60	1

100  
Platos  
Plates

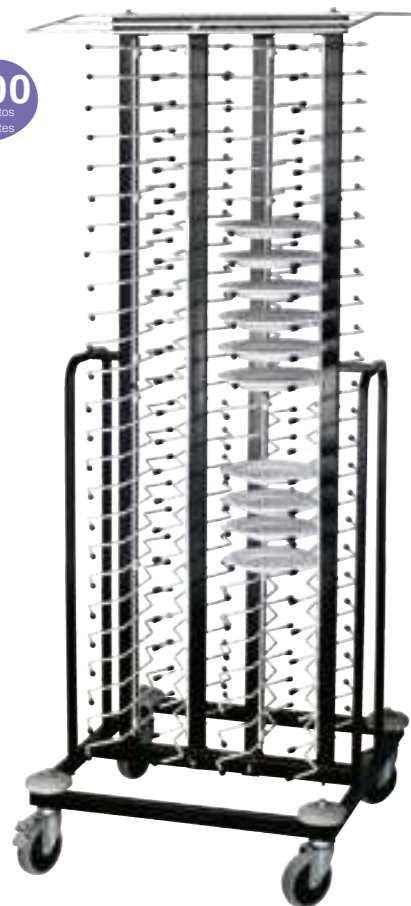

MAX: Ø28 cm  
MIN: Ø8 cm  
CAP: 100 units

Entrega montado  
Mounted delivery

### Carro portaplatos con ruedas

Hors devoirs chariot · Tellertransportwagen  
Stack trolley assembled · Carro porta-pratos com rodas

Ref	€	cm	U.Venta
66550	1.693,50	70x70x195	1

Entrega desmontado  
Dismantled delivery

### Carro portabandejas

Chariot à glissières · Gestellwagen  
Rack trolley · Carro porta-bandejas

Ref	€	Cubeta	Baldas	A (cm)	cm	U.Venta
66116	883,90	GN 1/1	17	7,5	38x55x172	1
66118	981,40	GN 2/1	17	7,5	58x69x172	1
66642	827,00	60x40	20	6,0	45x62x172	1



Inox  
18/10

50 Kg  
Por estante  
By shelf

Ø tubo · tube: 1,7 cm  
Separación entre tubos · Separation between tubes: 5 cm

### Estante tubular Inox

Étagère tubulaire en Inox · Rohrgestell-Regal, Rostfrei  
St. steel tubular shelf · Prateleira tubular Inóx

250 mm				400 mm				
Ref	€	L (mm)	L (mm)	Ref	€	L (mm)	L (mm)	U.Venta
56212	126,10	1200	250	56412	183,20	1200	400	1
56216	137,40	1600	250	56416	196,10	1600	400	1

# AUTOSERVICIO

## Bandejas

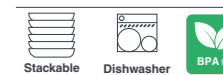

ES

- Ideal para diferentes colectivos como buffets, self-service, hospitales, colegios, guarderías, campamentos, etc.
- Compartimentos para alimentos y para cubiertos.
- Higiénicas, fáciles de recoger, limpiar y guardar; ocupan poco espacio.
- Apilables.

FR

- Idéal pour différents groupes tels que buffets, self-service, hôpitaux, écoles, crèches, camps, etc.
- Compartiments pour les aliments et pour les couverts.
- Hygiénique, faciles à collecter, nettoyer et ranger; il prend peu de place.
- Empilable.

EN

- Ideal for different groups such as buffets, self-service, hospitals, schools, nurseries, camps, etc.
- Compartments for food and for cutlery.
- Hygienic, easy to collect, clean and store; it takes up little space.
- Stackable.

La misma bandeja sirve como tapa  
The same tray serves as a lid

Inox  
18/10  
Si  
Silicone

Asas de silicona  
Silicone handles



5 compartimentos  
5 compartments

### Bandeja autoservicio

Plateau libre-service · Selbstbedienungstablett  
Self-service tray · Bandeja self-service

Ref	€	Material	cm	h (cm)	U.Venta
66957	25,70	Inox 18/10	32,5x37,5	3,6	1
66957Z	21,50	Inox	32,5x37,5	3,6	1
R66957A	0,80	Silicona	-	-	1

Set 2 asas silicona  
Set 2 silicone handles

A



Tapa apta para bandejas polipropileno  
Lid suitable for polypropylene trays

B



Tapa apta para bandejas policarbonato  
Lid suitable for polycarbonate trays

Tapas NO compatibles con la bandejas autoservicio INOX  
Lids NOT compatible with the INOX self-service trays

### Tapa para bandeja autoservicio

Couvercle pour plateau self-service · Deckel für Selbstbedienung Tablett  
Lid for self-service tray · Tampa para bandeja auto-serviço

Ref	€	Material	cm	U.Venta
A 66960	14,30	Polypropylene	53x37	1
B 66962	18,80	Polycarbonate	53x37	1



5 compartimentos  
5 compartments

### Bandeja autoservicio

Plateau self-service · Selbstbedienung Tablett  
Self-service tray · Bandeja auto-serviço

Ref	€	Material	cm	U.Venta
A 66952	19,50	Polycarbonate	33x33	1
B 66951	11,90	Polypropylene	33x33	1
C 66961	19,80	Polycarbonate	33x33	1



### Bandeja servicio

Plateau rectangulaire · Tablett, rechteckig  
Rectangular tray · Bandeja de servir

Ref	€	cm	U.Venta
66953	17,40	53x37	1

# ISOTÉRMICAS

## Bandejas

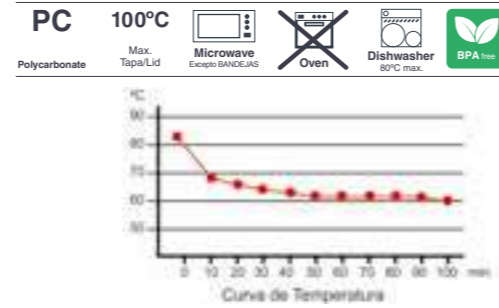

**COMPOSICIÓN:**  
66930 - Bandeja isotérmica B-1  
66933 - Plato llano con tapa  
66934 - Plato hondo con tapa  
66937 - Bol con tapa  
66959 - Bol rectangular con tapa  
66956 - Cierre portafichas hermético



### Bandeja isotérmica B-1

Plateau Isotherme B-1 · Isothermal Schale/Tablett B-1  
Isothermal B-1, Tray · Bandeja isotérmica B-1

Ref	€	cm	U.Venta
66930	206,30	53x36,5	1



### Plato llano policarbonato con tapa

Assiette plate polycarbonate avec couvercle · Grosser Teller, Polycarbonat mit deckel  
Polycarbonate dinner plate with lid · Prato raso policarbonato com tampa

Ref	€	cm	U.Venta
66933	15,40	Ø22x3	1
66933C	10,90	-	1
66940	4,60	-	12



### Bol policarbonato con tapa

Bol polycarbonate avec couvercle · Schüssel, Polycarbonat mit deckel  
Polycarbonate bowl with lid · Tijela policarbonato com tampa

Ref	€	cm	ml	U.Venta
66937	6,60	Ø13x6,5	450	1
66937C	5,10	-	450	1
66938	1,50	-	-	1



### Taza doble pared policarbonato con tapa

Coupelle dessert isotherme polycarb. a/couvercle · Doppelwandiger Becher mit Deckel  
Double wall polycarbonate mug w/lid · Chávena parede duplo com tampa

Ref	€	Ø (cm)	ml	U.Venta
66949	12,50	8,5x7	250	1
66949S	11,20	8,5x7	250	1
66949T	1,30	8,5	-	1



### Set completo bandeja isotérmica B-1

Set complet B-1 · Komplet-Set B-1  
Complete set B-1 · Conjunto completo bandeja isotérmica B-1

Ref	€	cm	U.Venta
66942	239,60	53x36,5	1



### Plato hondo policarbonato con tapa

Assiette creuse polycarbonate a/couvercle · Suppenteller, Polycarbonat mit deckel  
Polycarbonate soup plate with lid · Prato fundo policarbonato com tampa

Ref	€	cm	ml	U.Venta
66934	10,10	Ø19x5	450	1
66934C	5,70	-	450	1
66939	4,40	-	-	1



### Bol doble pared policarbonato con tapa

Bol isotherme polycarb. a/couvercle · Polycarbonat Schüssel, Isothermal mit Deckel  
Double wall polycarbonate bowl w/lid · Tijela parede dupla policarbonato c/ tampa

Ref	€	Ø (cm)	ml	U.Venta
66948	13,90	12,5x7	500	1
66948S	12,50	12,5x7	500	1
66938	1,50	12,5	-	1



### Taza desayuno policarbonato con tapa

Coupelle dessert polycarbonate a/couvercle · Frühstückstasse Polycarbonat m/Deckel  
Polycarbonate breakfast cup w/lid · Chávena pequeno-almoço com tampa

Ref	€	Ø (cm)	ml	U.Venta
66936	5,20	9x7	300	1
66936C	4,00	9x7	300	1
66936T	1,20	9	-	1



### Bol rectangular Policarbonato con tapa

Bac rectangulière en Polycarbonate a/couvercle · Behälter, Rechteckung mit Deckel  
Rectangular Polycarbonate bowl with lid · Caixa qrectangular policarbonato c/tampa

Ref	€	cm	ml	U.Venta
66959	8,10	9x13x4	400	1
66957S	4,90	-	-	1
66958	3,30	-	-	1



### Plato desayuno policarbonato

Assiette dessert polycarbonate · Frühstücksteller, Polycarbonat  
Polycarbonate breakfast plate · Prato de pequeno-almoço policarbonato

Ref	€	cm	U.Venta
66935	4,90	Ø18x2,5	1



### Vaso policarbonato

Verre polycarbonate · Glas, Polycarbonat  
Polycarbonate glass · Copo policarbonato

Ref	€	Ø (cm)	ml	U.Venta
66947	2,30	7x10	250	1
66932	3,20	8,3x9,5	300	12



### Jarra policarbonato

Pot verser polycarbonate · Krug, Polycarbonat  
Polycarbonate jug · Jarra policarbonato

Ref	€	L	U.Venta
66945	12,10	1,00	1
66945S	9,20	1,00	1
66945T	2,80	-	1

125°C max.



### Tapa cubreplatos redondo Policarbonato

Couvercle pour assiettes Polycarbonate · Polycarbonat Teller-Abdeckung  
Polycarbonate round plat cover · Tampa cobre-pratos redonda policarbonato

Ref	€	Ø (cm)	U.Venta
66950	12,00	25x7	1



### Bol cuadrado policarbonato con tapa

Bac carre en polycarbonate avec couvercle · Polycarbonat Behälter, Viereckung mit Deckel  
Square polycarbonate bowl with lid · Caixa quadrada policarbonato com tampa

Ref	€	cm	ml	U.Venta
66972	8,10	12x12x4,5	400	1
66972C	5,20	12x12x4,5	400	12
66975	2,90	12x12	-	1



### Bol rectangular policarbonato con tapa

Bac rectangulière en polycarbonate a/couvercle · Behälter, Rechteckung mit Deckel  
Rectangular polycarbonate bowl with lid · Caixa qrectangular policarbonato c/tampa

Ref	€	cm	ml	U.Venta
66974	10,80	17x12	600	1
66974C	6,70	17x11	600	1
66977	4,00	17x11	-	1

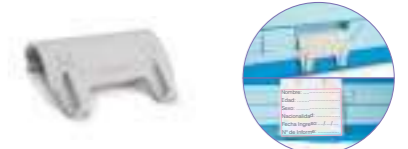

### Cierre portafichas hermético

Porte fiche · Halterung für Inhaltverzeichnis  
Index card fastener · Fecho para bandejas isotérmicas

Ref	€	U.Venta
66956	2,70	1

20 Bandejas Trays



### Carro portabandejas

Chariot plateau · Wagen für Schale/Tablett  
Isothermal tray trolley · Carro porta-bandejas

Ref	€	cm	U.Venta
66931	3.180,40	90x62x148	1



# ESTANTERÍAS

## Colección



### ES

- Las estanterías modulares LACOR no precisan para su montaje/desmontaje de herramienta alguna, son fáciles de montar, robustas y ligeras.
- Construidas en materiales de alta calidad garantizan una larga duración, además de adecuarse al uso alimenticio en cámaras refrigeradas. La construcción modular permite al cliente adecuarse a la longitud y espacios disponibles, pudiendo ampliar y modificar la distribución en cualquier momento.
- Diseñadas para poder emplear cubetas GASTRONORM 2/1, 1/1 y 2/3, con dos anchuras de fondo disponibles, 560 mm y 385 mm.
- La distribución de los estantes permite el máximo aprovechamiento de la altura disponible, con un máximo de 11 estantes en altura 1750 mm y 12 estantes en altura de 2000 mm, con un peso máximo aproximado por estantería de 1.200 Kg. Con una altura útil mínima de 100 mm es especialmente recomendada para el almacenaje de medicamentos, artículos de ferretería o alimentos en conserva.
- Las distintas alturas de los estantes y su fácil montaje/desmontaje, permite que las distancias entre estantes puedan variarse a razón de 150 mm adicionales a los 100 mm iniciales (100mm/250mm/400mm/550mm)

### FR

- Les étagères modulaires LACOR ne nécessitent aucun outil pour leur montage/démontage. Elles sont faciles à monter, robustes et légères.
- Elles sont construites dans des matériaux d'une grande qualité qui garantissent une longue durée de vie, et s'adaptent à une utilisation alimentaire dans les chambres froides.
- La construction modulable permet au client de les adapter à la longueur et aux espaces disponibles, avec la possibilité d'agrandir ou de modifier la distribution à tout moment.
- Conçues pour l'emploi de bacs GASTRONORM 2/1, 1/1 et 2/3, avec deux largeurs de fond disponibles, 560 mm et 385 mm L'agencement des étagères permet de profiter au maximum de la hauteur disponible, avec un nombre limite de 11 étagères en hauteur de 1750 mm et de 12 étagères en hauteur de 2000 mm, pour un poids maximum d'environ 1.200 Kg par étagère. Avec une hauteur utile minimale de 100 mm, elle est spécialement conseillée pour stocker des médicaments, des articles de quincaillerie ou des aliments en conserve.
- Les différentes hauteurs des étagères et leur facilité de montage/démontage permettent de varier la distance entre étagères de 150 mm supplémentaires par rapport aux 100 mm d'origine (100mm/250mm/400mm/550mm).

### EN

- No tools are required in the assembly/disassembly of LACOR modular shelving; they are easy to assemble, robust and light.
- Built in top-quality material, they are guaranteed to be long-lasting, and also apt for storing food in refrigerators.
- Their modular construction allows the client to fit them lengthwise into the available space, being able to expand and modify their distribution at anytime.
- Designed for use with GASTRONORM 2/1, 1/1 and 2/3 trays, with two available depths, 560mm and 385mm The shelves' distribution allows for maximum use of available height, with a maximum height of 11 shelves at 1750mm and 12 shelves 2000mm, with an approximate maximum weight of 1,200kg per shelf.
- With a minimum height of 100mm, it's especially recommended for storing medicine, tools or canned foods.
- The different shelf heights and easy assembly / disassembly make it so the distances between shelves can vary by 150mm from the initial 100mm (100mm/250mm/400mm/550mm).

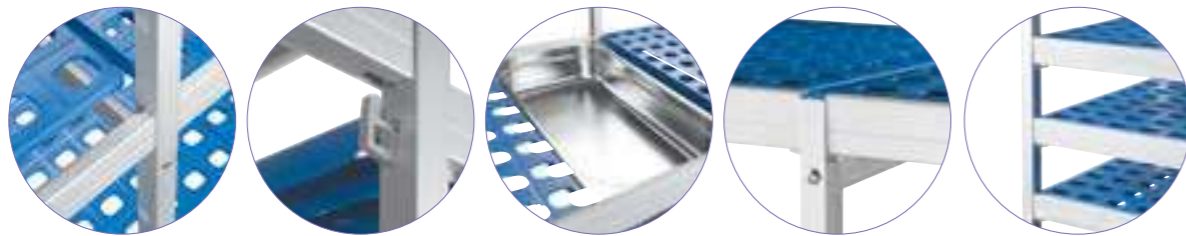

**Capacidad por estante**  
Capacity per shelf  
**Distribuir el peso uniformemente**  
Distributing the weight evenly

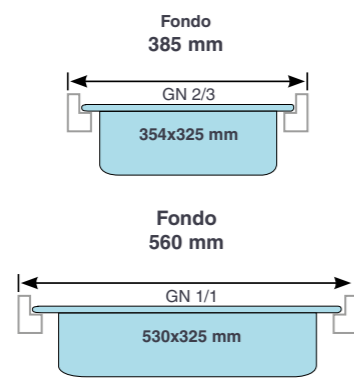
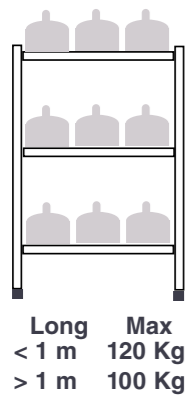

### Instrucciones montaje

Las estanterías LACOR no precisan de herramienta alguna para su montaje o desmontaje; siga estas instrucciones para poder realizar el montaje de una estantería simple. En caso de precisar cualquier aclaración o información adicional, no dude en ponerse en contacto con su suministrador o visite nuestra página web.

- Extraiga todos los componentes de su embalaje original, no se deshaga de este hasta comprobar que el artículo se encuentra completo. Coloque todos los componentes en el suelo.
- Disponga de un espacio libre, ampliamente superior a las dimensiones de la estantería a montar.
- Tome un soporte lateral extendido en el suelo, introduzca 2 ganchos en los orificios más bajos que vaya a emplear, tal y como muestra la figura 1. Apoye este soporte lateral contra la pared.
- Tome el otro soporte lateral e introduzca los ganchos en los mismos orificios. Coloque ahora los 2 largueros de la parte inferior (figura 2).
- Coloque de pie este soporte lateral y aproxímese al soporte lateral apoyado contra la pared, introduzca los largueros en los ganchos de éste, la estantería quedará estabilizada (figura 3). Asegúrese de que los largueros han sido correctamente colocados.
- Ahora puede seleccionar las diferentes alturas a las cuales colocará los ganchos y largueros de los estantes (figura 4).
- Antes de colocar las parrillas plásticas, asegúrese de que todos los largueros se encuentran correctamente colocados.
- Montaje guía ángulo:
  - Retire todas las parrillas plásticas y extraiga uno de los largueros de la estantería.
  - Introduzca 2 ganchos de ángulo en la barra ángulo tal y como muestra la figura (figura 6 y 7).  
NOTA: deberá emplear tantas barras ángulo como estantes disponga (figura 5).
  - Introduzca el larguero por la barra ángulo con los ganchos laterales (figura 8).
  - Ahora coloque el larguero con las barras ángulo en su anterior ubicación. Realice el mismo proceso con todos los largueros de uno de los laterales.
  - Una vez terminado, asegúrese de colocar todas las barras ángulo contra el mismo extremo, ahora realice el montaje de los 2 largueros de la parte inferior (figura 9).
  - Coloque en el nuevo soporte lateral 2 ganchos a la misma altura que la estantería ya montada.
  - Monte el nuevo soporte lateral a los largueros que forman el ángulo (figura 9); asegúrese de introducirlos correctamente.
  - Ahora ya puede montar el resto de largueros hasta finalizar el montaje.
  - Antes de colocar las parrillas plásticas, asegúrese de que todos los largueros se encuentran correctamente colocados  
NOTA: las patas pueden regularse en altura 1 cm para absorber irregularidades del suelo, emplee una llave inglesa o fija de 17 mm

### Mounting instructions

The LACOR shelves do not need any tool whatsoever to be assembled or dismantled. Follow these instructions to be able to assemble one single shelf. If you need any further explanation or information, do not hesitate to contact your supplier or visit our website.

- Take all the components out of their original wrapping. Do not throw the wrapping away until you have checked that the article is complete. Place all the components on the floor.
- Make a space available that is much larger than the shelf to be assembled.
- Take a side support lying on the floor and put two hooks into the lowest holes you are going to use, as shown in figure 1. Lean this support against the wall.
- Take the other side support and put the hooks into the same holes. Now place the 2 lower rods (figure 2).
- Stand this side support up and bring it next to the side support leaning against the wall. Put the rod lengths into its hooks. The shelf will remain stabilized (figure 3). Make sure the rod lengths have been properly placed.
- Now you can select the different heights at which you will place the hooks and the shelf rod lengths (figure 4).
- Before placing the plastic racks, make sure that all the rods are properly in place.
- Assembly of angle guide rail:
  - Remove all the plastic racks and take out one of the shelf rod lengths.
  - Put 2 angle hooks into the angle bar as shown (figure 6 and Figure 7).  
NOTE: you must use as many angle bars as the number of shelves you have (figure 5).
  - Put the rod length through the angle bar with the side hooks (figure 8).
  - Now place the rod length with the angle bars in its previous place. Follow the same process with all the rod lengths of one of the sides.
  - Once finished, make sure you place all the angle bars against the same end. Now assemble the 2 lower rod lengths (figure 9).
  - Place 2 hooks on the new side support at the same height as the shelf assembled.
  - Mount the new side support onto the rod lengths that form the angle (figure 9). Make sure you introduce them properly.
  - Now you can assemble the rest of the rod lengths until you finish the assembly.
  - Before placing the plastic racks, make sure that all the rod lengths are properly placed.  
NOTE: the legs can be adjusted by 1 cm in height to absorb unevennesses in the floor. Use an adjustable or 17 mm fixed spanner.

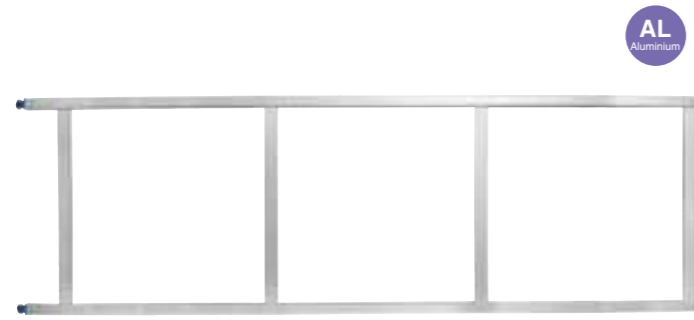

AL  
Aluminium

**Soporte lateral**  
Support latérale · Seitenständer  
Lateral support · Suporte latera

385 mm (GN 2/3)			560 mm (GN 1/1)		
Fondo / Width			Fondo / Width		
Ref	€	h (mm)	Ref	€	U.Venta
56302	32,40	250	57302	36,40	
56317	88,70	1750	57317	96,00	10 estantes (máx) · 10 shelves (max)
56320	103,70	2000	57320	110,80	12 estantes (máx) · 12 shelves (max)

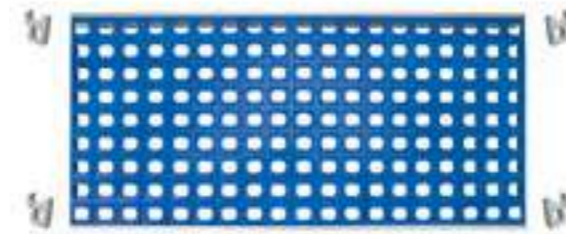

PP  
polypropylene

AL  
Aluminium

**Estantería completa**  
Rayonnage complet · Regale, komplett  
Full shelving · Estantes completa

385 mm (GN 2/3)			560 mm (GN 1/1)		
Fondo / Width			Fondo / Width		
Ref	€	L (mm)	Ref	€	U.Venta
56007	46,50	710	57007	54,80	1
56008	49,40	820	57008	57,80	1
56009	54,80	930	57009	62,80	1
56010	62,80	1035	57010	74,60	1
56011	67,90	1145	57011	79,50	1
56012	72,00	1255	57012	84,70	1
56013	74,60	1365	57013	89,50	1
56014	84,70	1470	57014	98,80	1
56015	87,10	1580	57015	104,40	1



AL  
Aluminium

**Set ángulo 90°**  
Jeu angle 90° · Eckesatz 90°  
90° corner set · Conjunto ángulo 90°

Ref	€	L (mm)	U.Venta
56330	15,30	385	1
57330	19,60	560	1

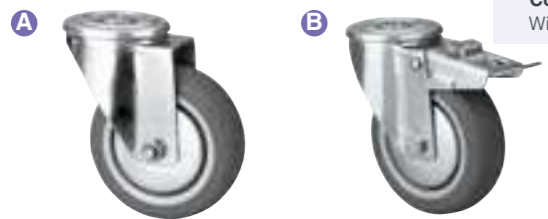

Con freno  
With brake

**Rueda para estantería**  
Roue pour étagère · Rad für Regal  
Shelf wheel · Roda para prateleira

	Ref	€	U.Venta
A	56522	45,30	1
B	56523	61,50	1



**Barra soporte lateral**  
Barre support latérale · Seitenständer stange  
Lateral support bar · Barra suporte lateral

Ref	€	h (mm)	U.Venta
56502	9,10	250	1
56517	32,20	1750	1
56520	35,40	2000	1

**Travesaño soporte lateral**  
Longeron support latérale · Seitenständer traverse  
Lateral support crossbar · Travesaño soporte lateral

Ref	€	L (mm)	U.Venta
56321	5,40	385	1
57321	8,00	560	1



AL  
Aluminium

**Travesaño**  
Longeron · Traverse  
Crossbar · Travesano

Ref	€	L (mm)	U.Venta
56507	14,10	654	1
56508	15,00	766	1
56509	17,20	876	1
56510	18,80	981	1
56511	20,30	1091	1
56512	21,80	1201	1
56513	23,20	1311	1
56514	24,70	1416	1
56515	25,60	1526	1



AL  
Aluminium

**Jgo. 4 ganchos ángulo**  
Jeu 4 crochet pour l'angle · 4 Satz Haken für ecke  
4 pcs. set corner hooks · Jogo 4 ganchos ángulo

Ref	€	U.Venta
56527	2,40	1



AL  
Aluminium

**Set ángulo 90°**  
Jeu angle 90° · Eckesatz 90°  
90° corner set · Conjunto ángulo 90°

Ref	€	L (mm)	U.Venta
56322	14,30	385	1
57322	18,50	560	1



Inox  
18/10

**Jgo. 6 tornillos**  
Jeu 6 vis en Inox · 6 Satz schrauben  
6 pcs. set screws · Jogo 6 parafusos

Ref	€	U.Venta
56526	2,20	1

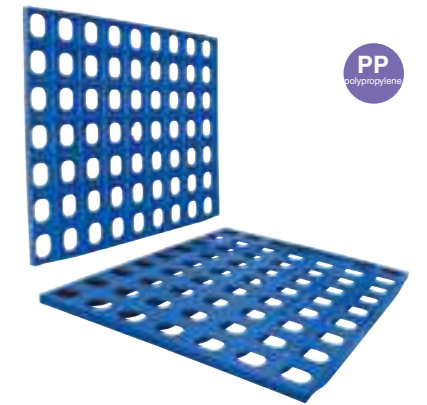

PP  
polypropylene

**Parrilla polietileno**  
Clayete en polyéthilène · Polyethylen Boden/Raster  
Polyethylene rack · Grelha polietileno

Ref	€	mm	U.Venta
56325	7,20	353x325	1
56435	8,30	353x425	3
57325	11,10	530x325	1
57435	13,60	530x435	1



AL  
Aluminium

**Jgo. 4 ganchos travesaño**  
Jeu 4 crochet pour longeron · 4 Satz Haken für traverse  
4 pcs. crossbar hooks · Jogo 4 ganchos travesano

Ref	€	U.Venta
56524	3,00	1



PP  
polypropylene

**Jgo. 2 pie nivelación**  
Jeu 2 pied nivellement · 2 Satz niveau füsse  
26 pcs. set level foot · 2 jogo pé nivelamento

Ref	€	U.Venta
56525	4,80	1





Fondo · Width: 385 mm  
Altura · Height: 2.000 mm



### Estantería completa

Rayonnage complet · Regale, komplett  
Full shelving · Estantes completa

#### 3 Estantes · Shelf

L (mm)	Ref	€	Desglose · Breakdown
710	55520	<b>350,40</b>	56320 x 2 + 56007 x 3
822	55521	<b>357,90</b>	56320 x 2 + 56008 x 3
932	55522	<b>371,60</b>	56320 x 2 + 56009 x 3
1037	55523	<b>394,80</b>	56320 x 2 + 56010 x 3
1147	55524	<b>410,60</b>	56320 x 2 + 56011 x 3
1257	55525	<b>423,50</b>	56320 x 2 + 56012 x 3
1367	55526	<b>430,80</b>	56320 x 2 + 56013 x 3
1472	55527	<b>460,80</b>	56320 x 2 + 56014 x 3
1582	55528	<b>468,20</b>	56320 x 2 + 56015 x 3

#### 4 Estantes · Shelf

Ref	€	Desglose · Breakdown
55557	<b>397,90</b>	56320 x 2 + 56007 x 4
55558	<b>408,30</b>	56320 x 2 + 56008 x 4
55559	<b>428,20</b>	56320 x 2 + 56009 x 4
55560	<b>458,20</b>	56320 x 2 + 56010 x 4
55561	<b>478,60</b>	56320 x 2 + 56011 x 4
55562	<b>495,40</b>	56320 x 2 + 56012 x 4
55563	<b>505,50</b>	56320 x 2 + 56013 x 4
55564	<b>545,50</b>	56320 x 2 + 56014 x 4
55565	<b>555,20</b>	56320 x 2 + 56015 x 4

#### 5 Estantes · Shelf

Ref	€	Desglose · Breakdown
55594	<b>445,60</b>	56320 x 2 + 56007 x 5
55595	<b>458,60</b>	56320 x 2 + 56008 x 5
55596	<b>483,40</b>	56320 x 2 + 56009 x 5
55597	<b>520,90</b>	56320 x 2 + 56010 x 5
55598	<b>546,50</b>	56320 x 2 + 56011 x 5
55599	<b>567,60</b>	56320 x 2 + 56012 x 5
55600	<b>580,00</b>	56320 x 2 + 56013 x 5
55601	<b>630,00</b>	56320 x 2 + 56014 x 5
55602	<b>642,40</b>	56320 x 2 + 56015 x 5



Fondo · Width: 560 mm  
Altura · Height: 1.750 mm



### Estantería completa

Rayonnage complet · Regale, komplett  
Full shelving · Estantes completa

#### 3 Estantes · Shelf

L (mm)	Ref	€	Desglose · Breakdown
710	55709	<b>357,90</b>	57317 x 2 + 57007 x 3
822	55710	<b>365,50</b>	57317 x 2 + 57008 x 3
932	55711	<b>379,80</b>	57317 x 2 + 57009 x 3
1037	55712	<b>415,50</b>	57317 x 2 + 57010 x 3
1147	55713	<b>431,20</b>	57317 x 2 + 57011 x 3
1257	55714	<b>446,00</b>	57317 x 2 + 57012 x 3
1367	55715	<b>460,80</b>	57317 x 2 + 57013 x 3
1472	55716	<b>490,90</b>	57317 x 2 + 57014 x 3
1582	55717	<b>505,70</b>	57317 x 2 + 57015 x 3

#### 4 Estantes · Shelf

Ref	€	Desglose · Breakdown
55746	<b>412,70</b>	57317 x 2 + 57007 x 4
55747	<b>422,20</b>	57317 x 2 + 57008 x 4
55748	<b>443,00</b>	57317 x 2 + 57009 x 4
55749	<b>490,70</b>	57317 x 2 + 57010 x 4
55750	<b>511,00</b>	57317 x 2 + 57011 x 4
55751	<b>530,70</b>	57317 x 2 + 57012 x 4
55752	<b>550,50</b>	57317 x 2 + 57013 x 4
55753	<b>590,30</b>	57317 x 2 + 57014 x 4
55754	<b>610,10</b>	57317 x 2 + 57015 x 4

#### 5 Estantes · Shelf

Ref	€	Desglose · Breakdown
55783	<b>468,60</b>	57317 x 2 + 57007 x 5
55784	<b>480,90</b>	57317 x 2 + 57008 x 5
55785	<b>506,30</b>	57317 x 2 + 57009 x 5
55786	<b>565,20</b>	57317 x 2 + 57010 x 5
55787	<b>590,50</b>	57317 x 2 + 57011 x 5
55788	<b>615,20</b>	57317 x 2 + 57012 x 5
55789	<b>639,90</b>	57317 x 2 + 57013 x 5
55790	<b>690,10</b>	57317 x 2 + 57014 x 5
55791	<b>714,40</b>	57317 x 2 + 57015 x 5

SIMPLE

DOBLE · DOUBLE

TRIPLE

SIMPLE

DOBLE · DOUBLE

TRIPLE





Fondo · Width: 560 mm  
 Altura · Height: 1.750 mm

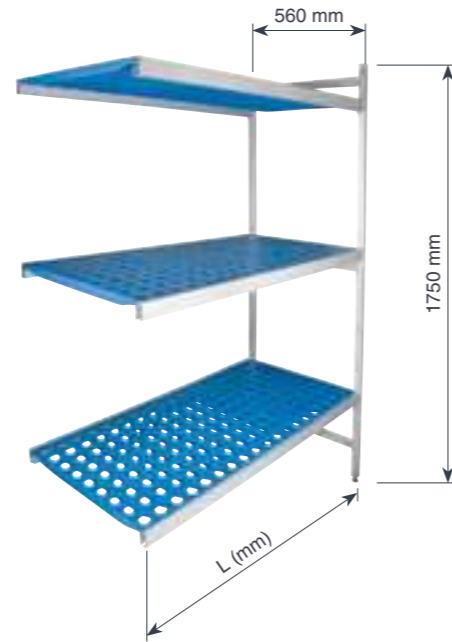

**Estantería abierta**  
 Rayonnage ouvertes · Offenes Regale  
 Open shelving · Estantes abiertas

**3 Estantes · Shelf**

L (mm)	Ref	€	Desglose · Breakdown
682	55931	261,80	57317 x 1 + 57007 x 3
794	55932	269,20	57317 x 1 + 57008 x 3
904	55933	284,40	57317 x 1 + 57009 x 3
1009	55934	320,00	57317 x 1 + 57010 x 3
1119	55935	334,80	57317 x 1 + 57011 x 3
1229	55936	350,10	57317 x 1 + 57012 x 3
1339	55937	364,80	57317 x 1 + 57013 x 3
1472	55938	393,40	57317 x 1 + 57014 x 3
1554	55939	409,60	57317 x 1 + 57015 x 3

**4 Estantes · Shelf**

Ref	€	Desglose · Breakdown
55940	317,40	57317 x 1 + 57007 x 4
55941	327,10	57317 x 1 + 57008 x 4
55942	347,20	57317 x 1 + 57009 x 4
55943	394,40	57317 x 1 + 57010 x 4
55944	414,90	57317 x 1 + 57011 x 4
55945	433,30	57317 x 1 + 57012 x 4
55946	454,20	57317 x 1 + 57013 x 4
55947	494,30	57317 x 1 + 57014 x 4
55948	514,10	57317 x 1 + 57015 x 4

**5 Estantes · Shelf**

Ref	€	Desglose · Breakdown
55949	371,60	57317 x 1 + 57007 x 5
55950	384,00	57317 x 1 + 57008 x 5
55951	410,00	57317 x 1 + 57009 x 5
55952	469,10	57317 x 1 + 57010 x 5
55953	494,40	57317 x 1 + 57011 x 5
55954	519,30	57317 x 1 + 57012 x 5
55955	543,80	57317 x 1 + 57013 x 5
55956	593,90	57317 x 1 + 57014 x 5
55957	618,60	57317 x 1 + 57015 x 5

SIMPLE



Fondo · Width: 560 mm  
 Altura · Height: 2.000 mm

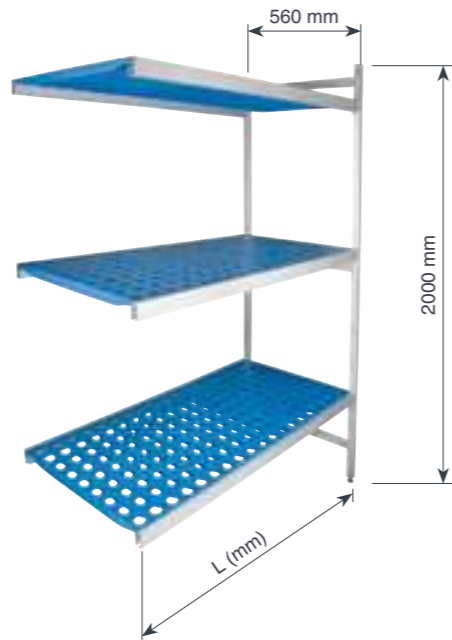

**Estantería abierta**  
 Rayonnage ouvertes · Offenes Regale  
 Open shelving · Estantes abiertas

**3 Estantes · Shelf**

L (mm)	Ref	€	Desglose · Breakdown
682	55958	276,70	57320 x 1 + 57007 x 3
794	55959	284,10	57320 x 1 + 57008 x 3
904	55960	299,30	57320 x 1 + 57009 x 3
1009	55961	334,50	57320 x 1 + 57010 x 3
1119	55962	350,10	57320 x 1 + 57011 x 3
1229	55963	364,80	57320 x 1 + 57012 x 3
1339	55964	379,50	57320 x 1 + 57013 x 3
1472	55965	409,60	57320 x 1 + 57014 x 3
1554	55966	424,50	57320 x 1 + 57015 x 3

**4 Estantes · Shelf**

Ref	€	Desglose · Breakdown
55967	332,10	57320 x 1 + 57007 x 4
55968	341,70	57320 x 1 + 57008 x 4
55969	361,90	57320 x 1 + 57009 x 4
55970	409,30	57320 x 1 + 57010 x 4
55971	429,60	57320 x 1 + 57011 x 4
55972	449,40	57320 x 1 + 57012 x 4
55973	469,10	57320 x 1 + 57013 x 4
55974	509,10	57320 x 1 + 57014 x 4
55975	528,80	57320 x 1 + 57015 x 4

**5 Estantes · Shelf**

Ref	€	Desglose · Breakdown
55976	386,70	57320 x 1 + 57007 x 5
55977	399,00	57320 x 1 + 57008 x 5
55978	423,80	57320 x 1 + 57009 x 5
55979	484,00	57320 x 1 + 57010 x 5
55980	509,20	57320 x 1 + 57011 x 5
55981	533,80	57320 x 1 + 57012 x 5
55982	558,60	57320 x 1 + 57013 x 5
55983	608,50	57320 x 1 + 57014 x 5
55984	633,40	57320 x 1 + 57015 x 5

SIMPLE

Cestas  
Racks



# CESTAS

## Colección



226 mm  
3° Suplemento  
185 mm  
208 mm  
164 mm  
144 mm  
2° Suplemento  
124 mm  
103 mm  
1° Suplemento  
82 mm

ALTURA DE CESTA / SUPLEMENTO  
ALTURA ÚTIL

**Verificador de diámetros**  
Vérifiez le diamètre · Chek the diameter · Diameter prufungen · Medidor de diámetros

<b>49</b>	Compart. Teillen	64x64 mm
<b>36</b>	Compart. Teillen	75x75mm
<b>25</b>	Compart. Teillen	90x90 mm
<b>16</b>	Compart. Teillen	113x113 mm

ES

- La alta calidad de sus materiales hacen que la resistencia al calor y a los impactos sea óptima, por lo que su durabilidad está garantizada.
- Su sistema único de apilación permite un fácil montaje, y lo que es más novedoso, el desmontaje del mismo siempre que usted lo desee.
- Su estructura abierta permite una mayor rapidez en el lavado y secado debido a una mejor circulación de agua y del aire.
- El diseño de las asas hacen que su manejo y carga sean cómodos y sin riesgos. Además, para facilitar su manejo, está disponible un carro porta cestas útil para evitar esfuerzos en los desplazamientos.
- Adaptable a la mayoría de las cestas existentes en el mercado.

FR

- Des matériaux de haute qualité garantissent une résistance optimale à la chaleur et aux chocs. La résistance à la chaleur et aux chocs est optimale, sa durabilité est donc garantie.
- Son système d'empilage unique permet un et, ce qui est encore plus innovant, le démontage de l'ensemble quand vous le souhaitez.
- Sa structure ouverte permet un lavage et un séchage plus rapides. Le lavage et le séchage sont plus rapides grâce à une meilleure circulation de l'eau et de l'air.
- La conception des poignées rend la manipulation et le chargement confortables et sûrs. La manipulation et le chargement sont confortables et sans risque. En outre, un chariot est disponible pour faciliter la manipulation.
- Adaptable à la plupart des paniers du marché sur le marché.

EN

- The high quality of the materials used in this range give total protection against heat and shocks and thus guarantees durability.
- The unique folding system enables racks to be constructed and dismantled at will.
- The open structure enables a better circulation of both water and air for an easier wash and dry.
- The handle design makes loading and transport easy and risk-free. As an option a dolly is available to assist in the handling of racks.
- This product is compatible with the majority of other dishwasher baskets on the market.



**Sistema único de apilación, permite un fácil montaje**  
Unique folding system enables racks to be constructed



### Cesta base

Casier universel · Spülkorb  
Universal open rack · Cesta base

Ref	€	cm	U.Venta
69235	34,70	35x35x12	1
69240	35,60	40x40x11	1



### Cesta base universal

Casier universel · Universalspülkorb  
Universal open rack · Cesta base universal

Ref	€	cm	U.Venta
69250	26,40	50x50x10,3	1



### Suplemento altura abierta

Réhausse sans compart. · Ergänzung  
Universal open extender · Suplem. altura aberto

Ref	€	cm	U.Venta
69251	11,00	50x50x4,5	1



### Cesta base 16 compartimentos

Casier 16 compartiments · Spülkorb 16-tlg.  
Rack with 16 compartments · Cesta base 16 compart.

Ref	€	cm	U.Venta
69214	31,60	50x50x10,3	1



### Suplem. altura 16 compartimentos

Réhausse, 16 comp. · Ergänzung 16-tlg. Spülkorb  
Extender for rack with 16 compart. · Suplem. altura 16 compart.

Ref	€	cm	U.Venta
69217	13,50	50x50x4,5	1



### Cesta base 25 compartimentos

Casier 25 compartiments · Spülkorb 25-tlg.  
Rack with 25 compartments · Cesta base 25 compart.

Ref	€	cm	U.Venta
69225	33,30	50x50x10,3	1



### Suplem. altura 25 compartimentos

Réhausse, 25 comp. · Ergänzung 25-tlg. Spülkorb  
Extender for rack with 25 compart. · Suplem. altura 25 compart.

Ref	€	cm	U.Venta
69226	14,40	50x50x4,5	1



### Cesta base 36 compartimentos

Casier 36 compartiments · Spülkorb 36-tlg.  
Rack with 36 compartments · Cesta base 36 compart.

Ref	€	cm	U.Venta
69236	35,00	50x50x10,3	1



### Suplem. altura 36 compartimentos

Réhausse, 36 comp. · Ergänzung 36-tlg. Spülkorb  
Extender for rack with 36 compart. · Suplem. altura 36 compart.

Ref	€	cm	U.Venta
69237	14,40	50x50x4,5	1



### Cesta base 49 compartimentos

Casier 49 compartiments · Spülkorb 49-tlg.  
Rack with 49 compartments · Cesta base 49 compart.

Ref	€	cm	U.Venta
69249	36,00	50x50x10,3	1



### Suplem. altura 49 compartimentos

Réhausse, 49 comp. · Ergänzung 49-tlg. Spülkorb  
Extender for rack with 49 compart. · Suplem. altura 49 compart.

Ref	€	cm	U.Venta
69248	15,30	50x50x4,5	1



### Cesta para platos

Casier pour assiettes · Tellerspülkorb  
Small trays and dishes rack · Cesta para pratos

Ref	€	cm	U.Venta
69202	26,50	50x50x10,3	1



### Cesta para platos

Casier pour assiettes · Tellerspülkorb  
Small trays and dishes rack · Cesta para pratos

Ref	€	cm	U.Venta
69234	35,30	35x35x12	1
69241	41,50	40x40x11	1



### Cesta para platos/bandejas

Casier pour grands platex · Plattenspülkorb  
Universal open side trays rack · Cesta pratos/bandejas

Ref	€	cm	U.Venta
69203	32,80	50x50x10,3	1



### Soporte para platos

Support pour les plats · Tellerhalter  
Plate holder · Suporte para pratos

Ref	€	cm	U.Venta
69207	10,30	31,0x9,5x7(15)	1
69213	11,80	34,5x9,5x7(17)	1



### Cesta para cubiertos

Casier à couverts · Besteckspülkorb  
Flatware/utensil rack · Cesta para talheres

Ref	€	cm	U.Venta
69204	26,10	50x50x10,3	1



### Tapa cesta universal

Couvercle pour casier universel · Deckel für Universals Spülkorb  
Standard rack's lid · Tampa cesta universal

Ref	€	cm	U.Venta
69205	20,80	50x50x2,5	1



### Cesta 8 compart. cubiertos

Panier à couverts, 8 compart. · Besteckspülkorb 8 tlg.  
Cutlery rack with 8 compart. · Cesta 8 compart. talheres

Ref	€	cm	U.Venta
69208	16,50	20,5x43x13	1



### Cubilete cubiertos

Petit panier à couverts · Besteckbehälter  
Cutlery cube · Cesta talheres

Ref	€	cm	U.Venta
69215	5,00	12,5x12,5x13,5	6



### Carro porta-cestas

Socle à roulettes pour casier · Transportwagen für Spülkoerbe  
Trolley for racks · Carro porta-cestas



Ref	€	cm	U.Venta
69211	206,60	55x57x80	1
69212	125,90	55x57x20	1

Sin asa  
Without handle

Limpeza  
Cleaning





# DISPENSADOR JABÓN/GEL

## Colección

ABS

Plastic



ES

- Dispensador manual de jabón y gel.
- Perfecto para almacenar y dispensar geles desinfectantes, jabones, champús u otros materiales líquidos.
- Tamaño compacto; ideal para oficinas, hogares, restaurantes, etc.
- Ventana transparente que permite controlar la cantidad de líquido disponible.
- Diseño para colocar en la pared y ahorrar espacio.
- Depósito extraíble para rellenar fácilmente.

FR

- Distributeur manuel de savon et gel.
- Parfait pour accueillir et distribuer du gel, du désinfectant, du savon, du shampoing, ou tout autre élément liquide.
- Taille compacte ; idéale pour les bureaux, la maison, les restaurants, etc.
- Fenêtre transparente qui permet de contrôler la quantité de liquide disponible.
- Conçu pour être installé sur un mur et ainsi gagner de l'espace.
- Réservoir extractible pour un remplissage facile.

EN

- Manual soap and gel dispenser.
- Perfect for storing and dispensing disinfectant gel, soap, shampoo or other liquids.
- Compact size; ideal for home, office, restaurants, etc.
- It has a transparent window so you can see how much liquid is available.
- It is designed for installing on the wall and to save space.
- Removable container for easy refilling.

PE

polyethylene



Fácil de rellenar  
Easy to fill

SAN

plastic



Fácil de rellenar  
Easy to fill

### Dispensadores de jabón/gel

Distributeur de savon et gel · Seifen- und Gelspender  
Soap and gel dispenser · Dispensador de sabão e gel

	Ref	€	ml	Color	U.Venta
A	91520	11,90	350	Cromado · Chrome	1
B	91521	10,80	350	Negro · Black	1

### Dispensadores de jabón/gel WHITE

Distributeur de savon et gel · Seifen- und Gelspender  
Soap and gel dispenser · Dispensador de sabão e gel

	Ref	€	L	U.Venta
	91525	24,00	1,10	1



Cierre con llave  
Lockable with a key

Funcionan con 4 pilas  
AA (No incluidas)  
Uses 4 AA batteries  
(not included)

ABS

plastic

PE

polyethylene

FE

Hardware

- Permite ubicar el dispensador de gel en cualquier lugar, sin necesidad de depender de ninguna pared o superficie vertical (Ref. 91540).
- Apto para gel hidroalcohólico y jabón líquido.
- Funcionamiento con sensor, detección entre 5-9 cm de altura.
- Opción de ajustar el caudal entre 0,5 y 2,5 ml.
- Ideal para zonas de gran movimiento de gente.
- Posibilidad de comprar el soporte solo o con el dosificador de gel.

- Permet d'installer le distributeur de gel n'importe où, sans avoir besoin d'un mur ou d'une surface verticale (Ref. 91540).
- Apte pour du gel hydroalcoolique et du savon liquide.
- Fonctionnement avec capteur, détection de 5 à 9 cm de hauteur.
- Option de réglage du débit de 0,5 à 2,5 ml.
- Idéal pour des zones de grand passage.
- Possibilité d'acheter le support seul ou avec le flacon doseur de gel.

- Lets you put a gel dispenser anywhere without needing to rely on any walls or vertical surfaces (Ref. 91540).
- Can be used with hydroalcoholic gel or liquid soap.
- Works using a sensor that can detect at a height of 5 cm to 9 cm.
- The flow can be adjusted from 0.5 ml to 2.5 ml.
- Perfect for areas with a lot of human traffic.
- The support is sold separately or with the gel dispenser.

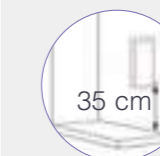

Posibilidad de colocar en pared  
Possibility of wall mounting



Fácil de rellenar  
Easy to fill

Dispensadores automáticos de jabón/gel  
Distributeur automatique de savon et gel · Automatischer Seifen- und Gelspender  
Automatic soap and gel dispenser · Dispensador automático de sabão e gel

	Ref	€	ml	cm	U.Venta
A	91522	80,00	850	11x12x26	1 SILVER
B	91523	80,00	850	11x12x26	1 WHITE



### Soporte dispensador de gel

Support distributeur de gel · Gelspenderhalter  
Gel dispenser holder · Suporte dispensador de gel

	Ref	€	h (cm)	U.Venta
A	91540	71,10	160	1 Soporte · Support
B	91541	149,20	160	1 Sop. + SILVER · Support + SILVER
C	91542	149,20	160	1 Sop. + WHITE · Support + WHITE



Orificio para colgar  
Hanging hole

Flexible y duradera  
Flexible and durable



### Escurreplatos de silicona

Tapis égouttoir en silicone · Abtropfmatte aus Silikon  
Silicone dish mat · Escorredor para pratos de silicona

	Ref	€	cm	U.Venta
	66774	17,70	42,5x32	1

- Escurreplatos de silicona antideslizante para colocar en la encimera y dejar secar los platos recién fregados.
- Su diseño con relieves proporciona una buena ventilación para un secado rápido de la vajilla, cacerolas, utensilios, platos, copas, etc.
- El agua queda retenida entre los surcos para su posterior vaciado en el fregadero.
- Fácil de enrollar para guardarla en cualquier cajón o armario de la cocina.

- Tapis égouttoir en silicone antidérapant à installer sur le plan de travail pour laisser sécher la vaisselle qui vient d'être lavée.
- Sa conception avec des reliefs apporte une bonne ventilation pour un séchage rapide de la vaisselle, des casseroles, des ustensiles, des assiettes, des verres, etc.
- L'eau est retenue entre les creux pour ensuite être évacuée dans l'évier.
- Facile à enrouler pour le ranger dans n'importe quel tiroir ou meuble de cuisine.

- Non-slip silicone dish mat to put on the countertop and let recently washed dishes dry.
- Its ridged design provides good ventilation for drying dishes, casseroles, utensils, plates or glasses quickly.
- The water gets captured between the grooves so it can be emptied into the wash basin.
- It's easy to roll up and store in any drawer or cabinet in the kitchen.

# PAPELERAS

## Colección

Inox  
PP  
Polypropylene  
Container



ES

- Fabricadas en acero inoxidable de gran calidad
- Tapa 100% de bambú natural (63335/63355).
- Ideal para baños de hoteles, restaurantes y todo tipo de establecimientos.
- Prácticas, compactas y funcionales.
- Superficie en acabado gris / blanco / negro mate.
- Apertura de tapa mediante pedal.
- Sistema de cierre SoftClosing; la tapa se cierra suave y silenciosamente.
- Cubeta interior extraíble de polipropileno con asa.
- Pies antideslizantes.

FR

- Fabriqué en acier inoxydable de haute qualité
- Couvercle en bambou 100 % naturel (63335/63355).
- Idéale pour les salles de bain des hôtels, des restaurants et de tout type d'établissement.
- Compactes et fonctionnelles.
- Surface in gray / white / matt black finish.
- Ouverture du couvercle par pédale.
- Système de fermeture **SoftClosing** : le couvercle se referme doucement et silencieusement.
- Cuve intérieure extractible en polypropylène a/anse.
- Pieds antidérapants.

EN

- Made of high quality stainless steel.
- 100% natural bamboo lid (63335/63355).
- Perfect for hotel bathrooms, restaurants and all kinds of businesses.
- Practical, compact and functional.
- Surface in grey / white / black matt finish.
- The lid opens using a pedal.
- SoftClosing system: the lid closes smoothly and silently.
- It has a removable polypropylene inner liner with a handle.
- Non-slip feet.



Tapa desmontable  
Tapa de práctico giro  
Removable lid  
Practical swing lid



Inox  
18/10

**Papelera sobremesa**  
Poubelle de table · Tisch-Abfallbehälter  
Table bin · Papeleira de mesa

Ref	€	Ø (cm)	h (cm)	L	U.Venta
63302	24,10	12	16	1,20	1



Sistema de cierre  
SoftClosing  
Closing system  
SoftClosing



Cubeta interior  
extraíble de  
polipropileno con  
asa  
It has a removable  
polypropylene inner  
liner with a handle

**Papelera con pedal INOX**  
Poubelle à pédale · Tret-Abfallbehälter  
Pedal bin · Papeleira com pedal

Ref	€	Ø (cm)	h (cm)	L	U.Venta
63303	22,10	17,0	25,5	3,0	1
63305	28,90	20,5	28,0	5,0	1
63312	42,70	25,0	40,0	12,0	1
63319	61,20	29,0	45,0	20,0	1



**Papelera con pedal**  
Poubelle à pédale · Tret-Abfallbehälter  
Pedal bin · Papeleira com pedal

Ref	€	Ø (cm)	h (cm)	L	Color	U.Venta
63306	23,30	16,8	25	3,0	GREY	1
63307	23,30	16,8	25	3,0	WHITE	1
63309	23,30	16,8	25	3,0	BLACK	1

Bambú  
Bamboo

FE  
Heraçion



**Papelera con pedal NATURE**  
Poubelle à pédale · Tret-Abfallbehälter  
Pedal bin · Papeleira com pedal

Ref	€	Ø (cm)	h (cm)	L	Color	U.Venta
63335	54,80	20,5	27,6	5,0	BLACK	1
63355	54,80	20,5	27,6	5,0	WHITE	1



Sistema de cierre  
SoftClosing  
Closing system  
SoftClosing



Cubeta interior  
extraíble de  
polipropileno con  
asa  
It has a removable  
polypropylene inner  
liner with a handle



Sistema de cierre  
SoftClosing  
Closing system  
SoftClosing



Cubeta interior  
extraíble de  
polipropileno con  
asa  
It has a removable  
polypropylene inner  
liner with a handle

# RECOGEMIGAS

## Colección

Inox  
18/10



**Cepillo recogemigas**

Ramasse-miettes à rouleaux · Krümelbürste  
Crumbs cleaner · Escova apanha-migalhas

Ref	€	cm	h (cm)	U.Venta
64407	14,70	9,5x16,5	4,0	1



**Cepillo recogedor HIPERLUXE**

Ramasse-miettes à rouleaux · Krümelbürste  
Crumbs cleaner · Escova apanha-migalhas

Ref	€	cm	U.Venta
64408	49,70	14,5x17	1

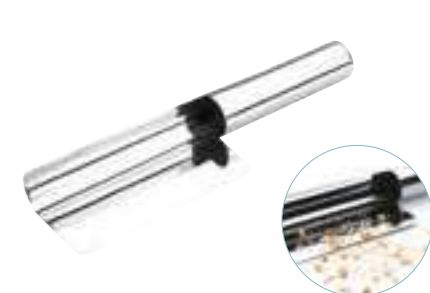

**Cepillo recogedor LUXE**

Ramasse-miettes à rouleaux · Krümelbürste  
Crumbs cleaner · Espátula apanha-migalhas

Ref	€	cm	U.Venta
64409	30,90	22x7	1

# PORTARROLLOS COCINA

## Colección

Inox  
18/10

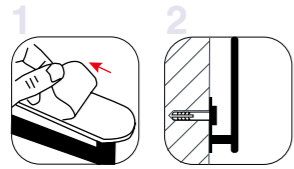

2 opciones para instalar  
2 options to install

- Fabricado en acero inoxidable de alta calidad, acabado negro mate.
- Duradero y resistente, a prueba de óxido.
- Diseño moderno y elegante. Capacidad: 1 rollo de cocina (longitud de rollos: 30 cm y 6 cm de grosor).
- Perfecto para colocar el papel de cocina y mantener la encimera despejada.
- Fácil de instalar. Opción de colocar mediante papel adhesivo o perforado con tornillos (ambos incluidos).
- Se puede instalar vertical u horizontalmente según las necesidades.

- Fabriqué en acier inoxydable de haute qualité, finition noire mate.
- Durable et résistant, antirouille.
- Design moderne et élégant. Capacité : 1 rouleau de papier de cuisine (longueur maximale de 30 cm et épaisseur de 6 cm).
- Parfait pour placer le rouleau de papier cuisine et garder le plan de travail dégagé.
- Facile à installer. Installation possible avec du papier adhésif ou perforé avec des vis (les deux inclus).
- Peut être installé verticalement ou horizontalement selon les besoins.

- Made of high quality stainless steel in a matt black finish.
- Long-lasting, sturdy and rust-proof.
- Modern, stylish design. Capacity: 1 kitchen roll (maximum length 30 cm, 6 cm thick).
- Perfect for paper kitchen rolls and keeping the worktop clear.
- Easy to install. Adhesive paper or screw hole mounting options (both included).
- Can be mounted vertically or horizontally as required.

Inox



### Portarrollos de cocina BLACK

Derouleur de cuisine · Küchenrollenspender  
Dispenser for kitchen · Porta-rolos cozinha

Ref	€	cm	h (cm)	U.Venta
62289	14,50	33,5x4,5	8	1



Base contrapeso  
Counterbalance base  
**1 Kg**



### Pie portarrollos

Dérouleur pour papier essuie-tout · Spänder für Küchenrolle  
Kitchen roll dispenser stand · Pé porta-rolos

Ref	€	Ø (cm)	h (m)	U.Venta
50301	19,90	15	32,5	6



Rollos aptos para los portarrollos · Rolls suitable for multiroll dispenser

Ref.	Film transparente · Transparent film	Rollo aluminio · Aluminium foil	Rollo papel · Paper roll
60701	Ø50x320 mm	Ø50x320 mm	Ø180x330 mm
60702	Ø48x340 mm	Ø60x340 mm	Ø170x330 mm

### Portarrollos de cocina de pared

Derouleur de cuisine · Küchenrollenspender  
Multiroll dispenser for kitchen · Porta-rolos cozinha de parede

Ref	€	U.Venta
A 60701	58,80	6
B 60702	55,40	8



### Bobina aluminio

Rouleau aluminium · Aluminiumfolie  
Aluminium foil · Bobina alumínio

Ref	€	Film (m)	Caja (cm)	Micras (µm)	U.Venta
10330	55,20	0,30x300	10x35	11	1
10430	67,80	0,40x300	10x42	11	1



### Bobina film transparente

Rouleau film transparent · Frischhaltefolie  
Transparent cling film · Bobina filme transparente

Ref	€	Film (m)	Caja (cm)	Micras (µm)	U.Venta
11330	14,10	0,30x300	10x33	10	1
11430	21,80	0,45x300	10x48	10	1

### Servilletero bar

Distributeur de serviettes bar · Serviettenspender  
Bar napkin holder · Guardanapo bar

Ref	€	cm	Servilleta	U.Venta
A 61001	13,20	8,5x12	90x125	1
B 61002	9,40	9,5x13,5	9,5x13,5	4

A



B



Inox



### Rasqueta profesional para grill

Racloir professionnel pour grill · Professioneller grillschaber  
Professional grill scraper · Raspador profesional para grill

Ref	€	cm	L Cuchilla (cm)	U.Venta
67034	70,70	42x15x12	15	1

AL  
Aluminium

FU  
Fundido  
Cast

- Fabricada en una sola pieza de aluminio fundido.
- Cuchillas de acero inoxidable intercambiables.
- Se utiliza para raspar los residuos de los alimentos y el carbón de las planchas.
- Ergonómico gracias a los dos puntos de sujeción.
- Protección contra salpicaduras de residuos durante la limpieza.

- Fabriqué en une seule pièce en fonte d'aluminium.
- Lames en acier inoxydable interchangeable.
- Utilisée pour racle les résidus des aliments et le charbon des planchas.
- Ergonomique grâce aux deux points de prise en main.
- Protection contre les éclaboussures de résidus pendant le nettoyage.

- Made of a single piece of cast aluminium.
- Interchangeable stainless steel blades.
- Used to scrape food and charcoal residue from grills.
- Ergonomic design with two hand-holds.
- Splash guard to prevent residue from splashing upward during cleaning.

# CENICEROS

## Colección

Inox  
18/10

ES

- Ceniceros para pared exterior.
- Cerradura con llave.
- Incluye material para fijación y una llave triangular.
- Cajetín interior de acero galvanizado extraíble para facilitar su limpieza.

FR

- Cendriers pour mur extérieur.
- Fermeture à clé.
- Comprend le matériel de fixation et une clé triangulaire.
- Boîtier intérieur en acier galvanisé extractible pour faciliter son nettoyage.

EN

- Outdoor wall ashtray.
- Lock with key.
- Includes attachment elements and triangular key.
- Removable galvanized steel inner box for easy cleaning.



Cajón extraíble de acero galvanizado  
Removable galvanized steel inner box

Cajón extraíble de acero galvanizado  
Removable galvanized steel inner box

Acero galvanizado  
Galvanized steel

### Cenicero pared

Mural cendrier · Wand aschenbecher  
Wall ash try · Cinzeiro de parede

	Ref	€	cm	h (cm)	U.Venta
A	63341	87,00	24,5x35	14	1
B	63342	81,50	25x35	8,5	1

### Cenicero redondo

Cendrier extérieur rond · Aschenbecher round  
Round ash try · Cinzeiro redondo

	Ref	€	Ø (cm)	L	U.Venta
	63331	91,00	8x46	1,70	1
A	R63331A	3,90	-	-	1
	63332	145,50	8x92	1,50	1
B	R63332A	3,90	-	-	1

A



Colocación en pared  
Wall mounting

B



Posición de pie  
Standing position

# POSTES SEPARADORES BLACK

## Colección

FE  
Hierro/Iron  
Inox

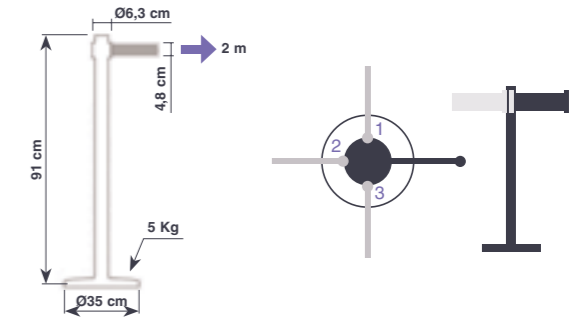
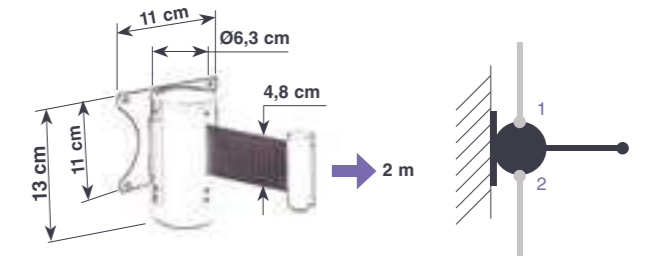

ES

- Ideal para la gestión de colas o separación de espacios.
- Estructura fabricada en hierro con recubrimiento de color negro.
- Cinta extensible retráctil de 2 m de longitud.
- Fácil de fijar y soltar las conexiones.

FR

- Idéal pour la gestion de files d'attente ou la séparation d'espaces.
- Structure fabriquée en métal, recouverte de couleur noire.
- Sangle extensible rétractable de 2 m de longueur.
- Facilité de fixation et de détachement des connexions.

EN

- Perfect for managing queues or separating spaces.
- Iron structure with black coating.
- 2 m long extendible retractable belt.
- The connections are easy to attach and release.

Dispone de 2 conexiones  
Permite conectar cintas para crear áreas separadas  
2 connections for connecting belts from other posts

Dispone de 3 conexiones  
Permite conectar cintas para crear áreas separadas  
3 connections for connecting belts from other posts



Fijación en pared  
Wall fixing

### Separador pared

Séparateur mural · Wandtrennpfosten  
Wall separator · Separador de parede

	Ref	€	metros	U.Venta
A	91530	36,60	2	1
B	R91533A	1,70	-	1

(Incluye R91533A · Included)  
(Apta para la ref. 91533 · Suitable for ref.91533)



Acero inoxidable  
Stainless steel

### Poste separador

Poteau séparateur · Trennpfosten  
Separator post · Poste separador

	Ref	€	metros	U.Venta
	91533	56,90	2	1



# 07

## Repostería Pastry

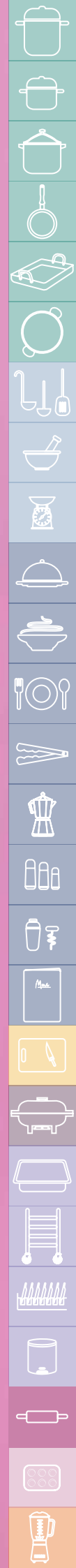

# JARRAS MEDIDORAS

## Colección

Inox  
18/10  
Dishwasher



Incluye borde para facilitar el vertido  
Includes rim for easy pouring



### Vaso medidor BASIC

Verre doseur · Messbecher  
Measuring cup · Copo medidor

	Ref	€	Ø (cm)	h (cm)	L	U.Venta
A	67075	7,40	8,5	16,0	0,5	1
B	67071	9,60	10,5	19,0	1,0	1

Marcajes de capacidad en ml, dl, onzas y cup  
Capacity markings in ml, dl, ounces and cups

## New



### Set 3 jarras medidoras

Setn 3 pichets doseurs · Messbecher, 3 Er-Setr  
Set of 3 measuring jugs · Conjunto 3 jarras medidas

Ref	€	Ø (cm)	h (cm)	L	U.Venta
67130	9,20	9,5	8,5	0,25	1
		11,0	10,0	0,50	
		13,0	11,5	1,00	

- Fabricadas en polipropileno de máxima calidad. 100% libres de BPA.
- Jarras graduadas en mililitros (ml), tazas (cup) y onzas (oz).
- Pico vertedor para facilitar el vertido y evitar derrames.
- Asa ergonómica con reposapulgares para facilitar el transporte, precisión y control en el vertido. Ambidiestro.
- Totalmente apilables, ocupando el mínimo espacio posible.

- Fabriqués en polypropylène de la plus grande qualité. 100% sans BPA.
- Pichets gradués en millilitres (ml), tasses (cup) et onces (oz).
- Bec verseur latéral pour mieux verser les liquides.
- Poignée ergonomique avec repose-pouces pour faciliter le transport et verser les liquides de façon plus précise et contrôlée. Ambidextre.
- Totalement empilables pour un gain de place maximum.

- Made of top quality polypropylene. 100% BPA free.
- Jugs graduated in millilitres (ml), cups (cup) and ounces (oz).
- Side spout for easy pouring.
- Ergonomic handle with thumb rest for easy carrying, precision and control when pouring. Ambidextrous.
- Fully stackable, taking up as little space as possible.



Marcajes de capacidad en el interior en onzas, ml, L y ccm (centímetro cúbico)  
Capacity markings inside in ounces, ml, L and ccm (cubic centimetres)

### Jarra medidora

Pot mesureur · Mass Behälter  
Measuring jug · Jarra de medidas

Ref	€	Ø (cm)	h (cm)	L	U.Venta	
A	62745	14,40	9,0	10,5	0,5	1
B	62741	21,80	11,5	13,0	1,0	1
C	62742	25,80	15,0	17,0	2,0	1



### Jarras medidoras

Pot mesureur · Mass Behälter  
Measuring jugs · Jarras de medidas

	Ref	€	Ø (cm)	h (cm)	L	U.Venta
A	67210	3,50	9,0	13,8	0,5	1
B	67211	4,60	12,0	17,0	1,0	1
C	67212	7,90	15,0	20,8	2,0	1
D	67213	10,30	17,0	23,5	3,0	1
E	67214	16,00	20,0	27,5	5,0	1



Sistema de lectura rápida en ml, L y ccm (centímetro cúbico)  
Easily readable markings in ml, L and ccm (cubic centimeter)



100% higiénica  
100% hygienic



Resistente a choques térmicos  
Highly resistant to thermal shock

### Jarra medidora CRISTAL

Pot mesureur · Mass Behälter  
Measuring jug · Jarra de medidas

Ref	€	L	U.Venta
67133	11,00	0,5	1



Sist. de lectura rápida en mililitros y cups  
Easily readable markings in millilitres and cups

### Jarra medidora SPIN

Pot mesureur · Mass Behälter  
Measuring jug · Jarra de medidas

Ref	€	L	U.Venta
67165	11,80	0,5	1



Lectura rápida en litros, mililitros, onzas y cups  
Readable markings in liters, millilitres, ounces and cups

### Juego 3 jarras medidoras

Ensemble de 3 pot mesureur · 3-tlg. Satz Messbecher  
3 piece measuring jugs · Jogo 3 jarras de medidas

Ref	€	L	U.Venta
67131	15,20	0,25-0,5-1,0	1



### Set 5 jarras medidoras

Setn 5 pichets doseurs · Messbecher, 5 Er-Setr  
Set of 5 measuring jugs · Conjunto 5 jarras medidas

Ref	€	cm	h (cm)	L	U.Venta
67215	39,90	15x9	15,3	0,5	1
		18x11	18,8	1,0	
		22x15	23,0	2,0	
		24x17	26,0	3,0	
		27x20	30,2	5,0	



Jarras apilables  
Stackable jugs

Sistema de lectura rápida en mililitros (ml), litros (L) y ccm (centímetro cúbico)  
Easily readable markings in millilitres (ml), Liters (l) and ccm (cubic centimeter)

# EXACT & PRACTIC

## Set de medición

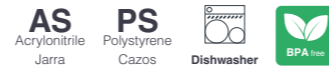

**ES** · Versátil. Ideal para ingredientes líquidos y secos.  
· Jarra con sistema de lectura rápida en litros y cups. Permite comprobar el nivel del líquido mientras se está vertiendo el contenido.  
· Cazos marcados en ml y bps para una rápida identificación.

**FR** · Polyvalent, idéal pour les ingrédients liquides et secs.  
· Pichet avec système de lecture rapide en litres et cups. Permet de vérifier le niveau du liquide tout en versant le contenu.  
· Cuillères marquées en ml et bps pour une identification rapide.

**EN** · Versatile: ideal for liquid and dry ingredients.  
· Jug with easy to see quantities marked in litres and cups and easy to check liquid level while pouring contents.  
· Ladles with ml and bps markings for easy reference.

Raspador · Scraper

6 cazos medidores

6 measuring cups  
(7,5 ml, 15 ml, 60 ml,  
85 ml, 125 ml, 250 ml)

Embudo · Funnel

Jarra medidora  
Measuring jug  
(1,0 L / 4 cups)

Compacto · Compact

### Set de medición EXACT

Set de mesure · Messbecher-Set  
Measuring set · Conjunto de medição

Ref	€	cm)	h (cm)	L	U.Venta
62740	16,00	20x11	13,6	1,0	1

**ES** · Fabricadas en polipropileno de máxima calidad. 100% Libre de BPA.  
· Pequeño vertedor lateral para facilitar el vertido.  
· Asas ergonómicas para facilitar el transporte.  
· 100% estable gracias a los pies antideslizantes.

**FR** · Fabriqués en polypropylène de la plus grande qualité. 100% sans BPA.  
· Petit verseur latéral pour verser plus facilement.  
· Poignées ergonomiques pour faciliter le transport.  
· 100% stables grâce aux pieds antidérapants.

**EN** · Made of top quality polypropylene. 100% BPA free.  
· Small side spout for easy pouring.  
· Ergonomic handles for easy carrying.  
· 100% with non-slip feet.

PP  
polypropylene

Jarra medidora · Measuring jug (0,5 L)

Jarra medidora · Measuring jug (1,0 L)

Escurridor · Colander (2,0 L)

Bol mezclador · Mixing bowl (3,5 L)

Apilables · Stackable

Graduadas (mililitros / cups)  
Graduated ml and cup marking

### Set 4 boles PRACTIC

Ensemble de 4 récipients · Schüsseln, 4er-Set  
Set of 4 bowls · Conjunto de 4 tigelas

Ref	€	Ø (cm)	h (cm)	L	U.Venta
62633	35,10	11,5	9,3	0,5	1
		14,5	10,6	1,0	
		18,5	13,0	2,0	
		22,0	15,0	3,5	

# CAZOS · CUCHARAS

## Medición



Graduadas y marcadas en ml y tsp  
Marked and graduated in ml and cups

Juego de cucharas medidoras  
Ensemble de cuillères à doser · Messlöffel-Set  
Measuring set · Jogo de colheres de medidas

	Ref	€	ml	U.Venta
A	67001	10,70	0,62/1,25/2,5/5/15	1
B	67037	4,00	1,25/2,5/5/15	1



Graduadas y marcadas en ml y tsp  
Marked and graduated in ml and cups

Juego de cazos medidores  
Ensemble de dosettes à doser · Mass-Pfännchen-Set  
Measuring cup · Jogo de caçaroles de medidas

	Ref	€	ml	U.Venta
A	67007	11,60	60/80/125/250	4
B	67036	6,10	60/80/120/180/235	4



Muestra los resultados en gramos (g) y onzas (oz)  
Shows the results in grams (g) and ounces (oz)

Cuchara medidora digital  
Cuillère avec Balance Digital · Digitale Löffelwaage  
Digital spoon scale · Colher de pesar Digital

Ref	€	g	División (g)	L (cm)	U.Venta
62519	39,50	300	0,10	28	1



### Librador

Pelle à farine · Mehlschaufel  
Ice shovel · Corredor

Ref	€	ml	L (cm)	A (cm)	U.Venta
67012	17,40	60	19,0	5,0	6
67013	20,30	110	21,5	6,0	6
67014	23,90	200	24,0	7,0	6
67016	26,60	260	25,5	8,5	1
67017	29,50	360	29,0	10,0	6
67018	31,80	470	31,0	11,0	6
67019	39,60	640	35,0	12,5	6
67020	47,40	860	38,0	14,0	6



· Calcula con exactitud el peso de cantidades pequeñas de especias, leche, aceite, harina o cualquier otro ingrediente.  
· Esta cómoda cuchara cabe en cualquier cajón y se puede colgar o colocar en cualquier estantería de la cocina.  
· Su nueva función de acumulación permite medir pesos hasta 3.000 g / 105,8 oz.  
· Desmontable.  
· Apagado automático tras 1 minuto sin usar.

· Provides a precise measuring result whenever you weigh a small quantity of spices, milk, oil, flour or other ingredients.  
· This very handy scale fits into any drawer or can be hung or placed on every kitchen rack. The new accumulation function now offers the possibility to measure weights up to 3000 g / 105.8 oz.  
· Removable.  
· Powers off automatically after 1 minute.

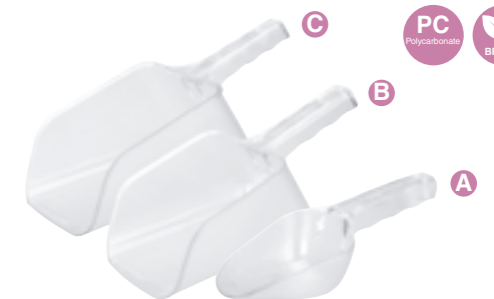

### Librador

Pelle à farine · Mehlschaufel  
Ice shovel · Corredor

	Ref	€	ml	Mango (cm)	U.Venta
A	67021	5,70	170	12	1
B	67022	11,60	900	12	1
C	67023	15,90	1800	14	1

# BOLES INOX

## Colección



ES

- Set de 3 boles de acero inoxidable de máxima calidad.
- Acabado interior y exterior satinado.
- Versátiles: ideales para mezclar, batir, preparar masas y servir ensaladas o salsas.
- Perfectos para almacenar y conservar los alimentos.
- Compuesto por 3 boles perfectamente apilables entre sí.
- Base 100% antideslizante.
- Incluye 3 tapas herméticas fabricadas en polipropileno, libres de BPA.
- Marcaje de capacidad en el interior (L).
- Fácil limpieza. No aptos para el lavavajillas.

FR

- Ensemble de 3 bols en acier inoxydable de la plus grande qualité.
- Finition intérieure et extérieure satinée.
- Polyvalents : parfaits pour mélanger, battre, préparer des pâtes et servir des salades ou des sauces.
- Parfaits pour ranger et conserver les aliments.
- Composé de 3 bols parfaitement empilables entre eux.
- Fond 100% antidérapant.
- Inclut 3 couvercles hermétiques fabriqués en polypropylène, sans BPA.
- Marquage de capacité à l'intérieur (L).
- Nettoyage facile. Ne convient pas au lave-vaisselle.

EN

- Set of 3 top quality stainless steel bowls.
- Inner and outer satin finish.
- Versatile: ideal for mixing, whisking, making doughs and serving salads or sauces.
- Ideal for storing and preserving food.
- Comprises 3 perfectly stackable.
- 100% non-slip base.
- Includes 3 airtight lids made of BPA-free polypropylene.
- Capacity marks inside (L).
- Easy to clean. Not suitable for the dishwasher.



### Set 3 boles INOX

Ensemble de 3 récipients · Schüsseln, 3er-Set  
Set of 3 bowls · Conjunto de 3 tigelas

Ref	€	Ø (cm)	h (cm)	L	U.Venta
60050	39,20	16	10,0	1,5	1
		18	11,0	2,2	
		20	12,5	3,0	
60051	52,80	20	12,5	3,0	1
		22	13,5	3,8	
		24	14,0	4,0	

garinox®



### Bol cónico

Bol conique · Schüssel, konisch  
Conical mixing bowl · Bacia cónica

Ref	€	Ø (cm)	h (cm)	L	U.Venta
14016	3,80	16	6,5	0,90	12
14019	5,20	20	7,5	1,40	12
14025	9,40	24	9,0	2,50	1
14029	12,80	30	11,0	4,30	1
14033	17,80	34	13,5	7,50	1
14040	22,70	40	15,5	11,50	1
14046	32,20	45	17,5	17,40	1
14049	37,80	50	19,0	22,60	1

# BOLES PP

## Colección



ES

- Versátiles: ideales para mezclar, batir, preparar masas y servir ensaladas o salsas.
- Compuesto por 3 boles perfectamente apilables entre sí.
- Dispone de pico vertedor y pestaña de agarre antideslizante.
- Base 100% antideslizante.

FR

- Polyvalents : parfaits pour mélanger, battre, préparer des pâtes et servir des salades ou des sauces.
- Composé de 3 bols parfaitement empilables entre eux.
- Bec verseur et poignée antidérapante pour une meilleure prise en main.
- Fond 100% antidérapant.

EN

- Versatile: ideal for mixing, whisking, making doughs and serving salads or sauces.
- Comprises 3 perfectly stackable bowls.
- Featuring a pouring spout and non-slip grip. 100% non-slip base.



### Set 3 boles GREY

Ensemble de 3 récipients · Schüsseln, 3er-Set  
Set of 3 bowls · Conjunto de 3 tigelas

Ref	€	Ø (cm)	h (cm)	L	U.Venta
60054	41,80	21,0	12,5	1,4	1
		26,0	14,2	2,8	
		31,2	14,8	4,7	

ES

- Versátiles: ideales para mezclar, batir, preparar masas, servir ensaladas o salsas.
- Compuesto por 6 boles perfectamente apilables entre sí.
- Incluye 6 tapas fabricadas en polipropileno, libres de BPA.
- Perfectos para almacenar y conservar los alimentos.

FR

- Polyvalents : parfaits pour mélanger, battre, préparer des pâtes et servir des salades ou des sauces.
- Composé de 6 bols parfaitement empilables entre eux.
- Comprend 6 couvercles en polypropylène, sans BPA.
- Parfait pour stocker et conserver les aliments.

EN

- Versatile: ideal for mixing, whisking, making doughs, serving salads or sauces.
- Comprises 6 perfectly stackable bowls.
- Includes 6 lids made of polypropylene, BPA free.
- Perfect for storing and preserving food.



Cuerpos aptos para el lavavajillas  
Dishwasher safe bodies

### Set 6 boles MULTI

Ensemble de 6 récipients · Schüsseln, 6er-Set  
Set of 6 bowls · Conjunto de 6 tigelas

Ref	€	Ø (cm)	h (cm)	L	U.Venta
60055	20,00	10,0	5,0	0,25	1
		14,0	6,8	0,80	
		17,0	8,0	1,15	
		20,3	9,5	2,00	
		24,3	11,0	3,35	
		28,3	12,5	5,25	



# CALDEROS INOX

## Colección

Inox 18/10 

ES

- Ideal para mezclar los alimentos.
- Para uso profesional o doméstico.
- Fabricados en acero inoxidable 18/10, material muy resistente a la corrosión y ácidos alimentarios.
- Fácil limpieza: apto para el lavavajillas.

FR

- Idéal pour mélanger les aliments.
- Pour un usage professionnel ou domestique.
- Fabriqué en acier inoxydable 18/10, un matériau hautement résistant à la corrosion et aux acides.
- Nettoyage facile : passe au lave-vaisselle.

EN

- Ideal for mixing food.
- For professional or home use.
- Made of 18/10 stainless steel, a material highly resistant to corrosion and food acids.
- Easy cleaning: dishwasher safe.



### Caldero semiesférico sin asas

Bassine hemispherique s/anses · Schneeschlagkessel ohne Griffe  
Semi-spherical mixing bowl w/out/handles · Bacia semi-esférica sem asas

Ref.	€	Ø (cm)	h (cm)	L	U.Venta
50323S	36,50	22	11,0	2,70	1
50327S	42,60	26	13,0	4,00	1
50333S	57,20	32	17,0	9,50	1
50337S	64,90	36	18,0	12,00	1
50341S	108,90	40	21,0	14,50	1
50300	25,70	-	-	-	1

**Soporte**  
Bowl stand



### Caldero semiesférico con asas

Bassine hemispherique a/anses · Schneeschlagkessel mit Griffe  
Semi-spherical mixing bowl w/handles · Bacia semi-esférica com asas

Ref.	€	Ø (cm)	h (cm)	L	U.Venta
50323	48,10	22	11,0	2,70	1
50327	54,70	26	13,0	4,00	1
50333	70,30	32	17,0	9,50	1
50337	75,60	36	18,0	12,00	1
50341	108,10	40	21,0	14,50	1
50300	25,70	-	-	-	1

**Soporte**  
Bowl stand



### Caldero cónico

Bassine conique · Wanne  
Mixing bowl · Bacia cónica

Ref.	€	Ø (cm)	h (cm)	L	U.Venta
60013	12,40	13	6,1	0,55	1
60016	13,40	16	9,1	1,00	1
60020	18,40	20	11,7	2,12	1
60024	22,10	24	12,6	3,50	1
60028	27,60	28	13,4	5,25	1
60032	31,00	32	15,0	7,65	1
60036	42,90	36	16,0	11,00	1
60040	49,80	40	18,0	15,00	1



### Caldero cónico con asas

Bassine conique à anses · Wanne mit Griffe  
Conical mixing bowl · Bacia cónica con asas

Ref.	€	Ø (cm)	h (cm)	L	U.Venta
50828	43,10	28	13,2	5,00	1
50832	47,80	32	14,5	7,00	1
50836	54,70	36	16,0	11,00	1
50840	60,80	40	18,0	15,00	1
50845	72,60	45	20,0	22,00	1
50850	87,10	50	21,0	30,00	1

# CEDAZOS INOX

## Colección

Inox 18/10 

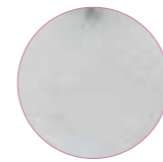

50 orificios/pulgada  
50 eyes/inch  
Cuadrado: 0,35x0,35 mm  
Square: 0,35x0,35 mm



35 orificios/pulgada  
35 eyes/inch  
Cuadrado: 0,50x0,50 mm  
Square: 0,50x0,50 mm

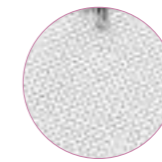

25 orificios/pulgada  
25 eyes/inch  
Cuadrado: 0,75x0,75 mm  
Square: 0,75x0,75 mm

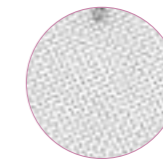

20 orificios/pulgada  
20 eyes/inch  
Cuadrado: 1x1 mm  
Square: 1x1 mm

### Cedazo

Tamis · Mehlsieb  
Sieve · Peneira



Hilos por pulgada · Wires-inch= 50				Hilos por pulgada · Wires-inch= 35				Hilos por pulgada · Wires-inch= 25				Hilos por pulgada · Wires-inch= 20			
Ref	€	Ø (cm)	U.Venta	Ref	€	Ø (cm)	U.Venta	Ref	€	Ø (cm)	U.Venta	Ref	€	Ø (cm)	U.Venta
68058	38,50	18	1	68350	38,70	20	1	68250	38,40	20	1	68026	60,60	26	1
68050	42,10	20	1	68357	58,30	26	1	68252	57,90	26	1	68023	67,50	30	1
68057	58,40	26	1	68351	66,00	30	1	68253	64,40	30	1	68024	101,80	40	1
68053	70,40	30	1	68354	98,70	40	1	68254	99,70	40	1				
68054	96,10	40	1												

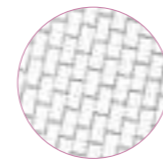

9 orificios/pulgada · 8 eyes/inch  
Cuadrado · Square: 2x2 mm  
Ø Varilla · Rod: 0,40 mm



20 orificios/pulgada · 20 eyes/inch  
Cuadrado · Square: 1x1 mm  
Ø Varilla · Rod: 0,27 mm

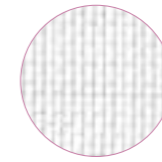

12 orificios/pulgada · 12 eyes/inch  
Cuadrado · Square: 1,35x1,35 mm  
Ø Varilla · Rod: 0,35 mm

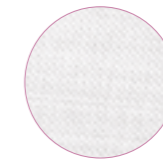

40 orificios/pulgada · 40 eyes/inch  
Cuadrado · Square: 0,7x0,7 mm  
Ø Varilla · Rod: 0,12 mm



### Cedazo 4 mallas intercambiables

Tamis à 4 mailles interchangeables · 4 Austauschbare Masche-Sieb  
Mesh sieve interchangeable · Peneira de 4 malha intercambiáveis

Ref	€	Ø (cm)	U.Venta
68340	33,00	20	1
68341	39,80	23	1
68342	49,40	25	1

Ideal para harina, chocolate en polvo, levaduras, etc.

Mecanismo en el asa en forma de gatillo

Ideal for flour, chocolate powder, yeasts, etc.

Trigger handle mechanism

Inox



20 orificios/pulgada · 20 eyes/inch

### Cribador de harina INOX

Tamis · Mehlsieb  
Flour sifter · Crivador de farinha

Ref	€	Ø (cm)	Kg	U.Venta
67011	10,60	10,0	0,35	5
67015	14,10	12,0	0,50	1

AS

plastic

BPA free



### Cribador de harina

Tamis · Mehlsieb  
Flour sifter · Crivador de farinha

Ref	€	Ø (cm)	Kg	U.Venta
67025	7,20	10	0,35	6

# BATIDORES

## Colección

Inox  
18/10  
Dishwasher



Inox



### Batidor MINI

Mini fouet Inox · Mini-Schneebeesen  
Mini whisk · Mini batedor Inóx

Ref	€	L (cm)	U.Venta
61615	5,40	15	12
61620	6,00	20	12



### Batidor EXTRA 8

Fouet inox extra 8 · Schneebeesen, Extra 8  
Extra 8 whisk · Batedor Extra 8

Ref	€	L (cm)	U.Venta
61625	8,50	25	6
61630	8,70	30	6
61635	9,10	35	6
61640	10,00	40	6
61645	10,80	45	6
61650	12,10	50	6
61655	12,80	55	6
61660	13,80	60	6



### Batidor SUPER 12

Fouet inox super 12 · Schneebeesen, super 12  
Super 12 whisk · Batedor Super 12

Ref	€	L (cm)	U.Venta
61626	7,80	25	6
61631	8,40	30	6
61636	9,10	35	6
61641	9,60	40	6
61646	9,90	45	6
61651	10,80	50	6

Si  
Silicone  
250  
°C  
BPA free

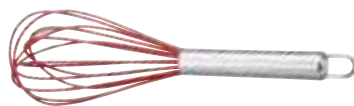

### Batidor varilla silicona

Fouet en silicone · Ruhrbesen auf Silikon  
Silicone wire whisk · Batedor vareta silicone

Ref	€	L (cm)	U.Venta
61621	8,00	20	12
61622	8,90	25	6
61623	9,90	30	12



### Batidor gigante

Fouet à purée · Kesselbesen  
Big whisk · Batedor gigante

Ref.	€	cm	Ø Varilla (mm)	U.Venta
60610	62,40	100	3	12
60612	80,00	129	3	12

Si  
Silicone  
LFGB  
BPA free

A



Mango de Haya natural  
Natural beech handle

B



### Batidor varilla con espátula

Fouet avec grattoir · Schneebeesen mit Schaber  
Whisk with spatula · Batedeira de varas com espátula

	Ref	€	L (cm)	U.Venta
A	68199	5,90	27,0	1
B	61627	6,20	32,0	12

- Indeformable. Varillas de acero inoxidable 18/10. Mango de fibra de vidrio resistente.
- Ideal para batir crema de leche, huevos, claras a puntode nieve, masas ligeras, cremas, etc.

- Indéformable. Tiges en acier inoxydable 18/10. Manche en fibre de verre durable.
- Idéal pour fouetter la crème, les œufs, les blancs d'œufs, les pâtes légères, les crèmes, etc.

- Non-deformable. 18/10 stainless steel rods. Durable fibreglass handle.
- Ideal for whipping cream, eggs, egg whites, egg whites, light doughs, creams, etc.

Si  
Silicone  
250  
°C  
BPA free



### Batidor FIBREGLASS

Fouet · Schneebeesen  
Whisk · Batedores

Ref	€	L (cm)	U.Venta
61624	11,80	25	6
61629	13,60	30	6
61634	15,40	35	6
61639	17,00	40	6
61644	20,40	45	6
61649	21,40	50	6



### Batidor silicona FIBREGLASS

Fouet en silicone · Schneebeesen, Silikon  
Silicone whisk · Batedores silicona

Ref	€	L (cm)	U.Venta
61524	10,80	25	6
61529	11,70	30	6
61534	13,60	35	6



Mango ergonómico  
Ergonomic handle

### Batidor FIBREGLASS

Fouet · Schneebeesen  
Whisk · Batedores

Ref	€	L (cm)	U.Venta
61590	10,80	25	6
61591	11,70	30	6
61592	13,60	35	6

New

- Especial para preparar comidas que no contengan alérgenos.

- Spécialement pour la préparation de repas ne contenant pas d'allergènes.
- Specially for preparing meals that do not contain allergens.

Inox



### Batidor manivela

Batteur-mélangeur à manivelle · Schneequirl  
Egg beater · Batedor de manivela

Ref	€	U.Venta
62901	19,10	6



### Batidor capuccino

Batteur pour cappuccino · Capuccino- Mixer  
Capuccino mixer · Batedor capuccino

Ref	€	W	U.Venta
69041	26,70	2,7	1

# ESPÁTULAS SILICONA

## Colección



ES

- Fabricados en silicona de alta calidad libre de BPA.
- Núcleo reforzado para una mayor resistencia sin perder flexibilidad en los bordes. Diseñados en una sola pieza, sin costuras ni grietas.
- Resistentes a altas temperaturas.
- Mango ergonómico suave al tacto y antideslizante.
- No rayan ni dañan artículos de cocina con antiadherente.
- Fáciles de limpiar. Aptas para el lavavajillas.

FR

- Fabriqué en silicone de haute qualité sans BPA.
- Noyau renforcé pour une résistance accrue sans perte de flexibilité des bords. Conception monobloc, sans coutures ni fissures.
- Résistant aux hautes températures.
- Poignée ergonomique, douce au toucher et antidérapante.
- Ne raye pas et n'endommage pas les ustensiles de cuisine antiadhésifs.
- Facile à nettoyer. Lavable au lave-vaisselle.

EN

- Made of high quality BPA free silicone.
- Reinforced core improves strength without losing flexibility around the edges. Designed in a single piece without seams or cracks.
- Can withstand high temperatures.
- Soft and non-slip ergonomic handle.
- Does not scratch cooking utensils with non-stick coating.
- Easy to clean. Dishwasher safe.



### Utensilios GREY

Ustensiles en silicone · Silikonutensilien  
Silicone utensils · Utensílios de silicone

	Ref	€	L (cm)	U.Venta
	64459	15,60	27,5	1
A	64463	5,50	27,5	1
B	64464	5,50	27,5	1
C	64465	5,60	27,5	1

### Utensilios OCEAN

Ustensiles en silicone · Silikonutensilien  
Silicone utensils · Utensílios de silicone

	Ref	€	L (cm)	U.Venta
	64452	16,70	27,5	1
	64453	5,80	27,5	1
	64454	5,80	27,5	1
	64455	5,80	27,5	1

Set 3 utensilios · Set 3 utensils

Cuchara · Spoon

Espátula · Spatula

Pincel · Brush



### Espátula silicona

Spatule en silicone · Teigschaber  
Silicone spatula · Espátula de silicone

	Ref	€	L (cm)	U.Venta
A	64444	5,90	28	1
B	64445	6,60	30	1
C	64446	6,70	31	1



### Espátula silicona

Spatule en silicone · Teigschaber  
Silicone spatula · Espátula de silicone

	Ref	€	L (cm)	U.Venta
	67421	4,60	20	1
A	67427	6,80	26	1
	67433	14,90	32	1
B	67434	4,70	30	12
	67435	5,40	29	12



### Espátula UNITE

Spatule · Backschauffel  
Spatule · Espátula

	Ref	€	cm	L (cm)	U.Venta
	68195	4,30	5,6x8,5	26,5	1



Mango de polipropileno  
Polypropylene handle

### Espátula silicona

Spatule en silicone · Teigschaber  
Silicone spatula · Espátula de silicone

	Ref	€	L (cm)	U.Venta
	64450	5,60	25	6
A	64451	8,90	35	6
B	64460	5,80	25	6
	64461	9,70	35	6

## New

### Espátula para tarros

Spatule pour pots · Spatel für Einmachgläser  
Jar spatula · Espátula para frascos

	Ref.	€	cm	L (cm)	U.Venta
A	64490	2,40	3,8x8,4	25	1
B	64491	4,00	4,8x10,8	35	1



- Fabricada en silicona y ABS de alta calidad, libre de BPA.
- Resistente a altas temperaturas.
- Cabezal flexible y maleable. No raya ni daña artículos de cocina con antiadherente.
- Diseñada especialmente para rebañar tarros a la perfección, aprovechando hasta lo último de mermeladas, mayonesas, salsas, etc.
- Higiénica. Fácil de limpiar. Apta para el lavavajillas.

- Fabriqué en silicone et ABS de haute qualité sans BPA.
- Résistant aux températures extrêmes.
- Tête flexibilité et malléabilité. Ne raye pas et n'endommage pas les ustensiles de cuisine antiadhésifs.
- Spécialement conçue pour racler les pots à la perfection, récupérant ainsi les dernières gouttes de confiture, mayonnaise, sauce, etc.
- Hygiénique. Faciles à nettoyer. Lavable au lave-vaisselle

- Made of high quality BPA free silicone and ABS.
- Resistant to extreme temperatures.
- Flexible and malleable head. Does not scratch cooking utensils with non-stick coating.
- It's specially designed for scraping all kinds of jars to perfection, so you can enjoy every last bit of your marmalade, mayonnaise or sauce, etc.
- Hygienic. Easy to clean. Dishwasher safe.

### Set repostería (20 pcs.)

Exposant pâtisserie · Aufsteller Pastry  
Pastry display · Expositor pasteleria

	Ref	€	L (cm)	Pieza	U.Venta
	64424	78,30	-	Caja (20 pcs.) / Set (20 pcs.)	1
A	64426	4,00	23,0	Pincel / Brush	12
B	64427	4,00	23,0	Espátula / Spatula	12
C	64428	4,00	23,0	Lengua gato / Spatula	12
D	64429	4,00	23,0	Batidor / Whisk	12



## New

### Espátula profesional EXTRAplana

Spatula professionnelle · Profi-Spachtel  
Professional spatula · Espátula profesional

	Ref	€	L (cm)	U.Venta
A	61373	5,50	30	1
B	61375	6,00	35	1
C	61374	7,30	40	1



- Espátula extraplana fabricada en nylon y fibra de vidrio especialmente diseñada para uso profesional.
- Sólida e indeformable. Resistente a altas temperaturas.
- No absorbe olores ni sabores.
- Apta para el lavavajillas.

- Spatule extra plate fabriquée en nylon et fibre de verre spécialement conçue pour un usage professionnel.
- Résistante aux hautes températures.
- Solide et indéformable. N'absorbe ni les odeurs ni les goûts.
- Apte pour le lave-vaisselle.

- Super thin, glass fibre nylon spatula, specially designed for professional use.
- High temperature resistant.
- Robust and non-deformable.
- Does not absorb smells or flavours.
- Dishwasher safe.

# PINCELES

## Colección

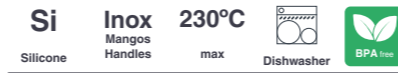

ES

- Para cocina o repostería.
- Prácticas espátulas o lenguas de gato para rebañar boles, cazuelas, fuentes, etc.
- Pinceles ideales para pincelar con aceites o salsas, marinar carnes o pescados, engrasar moldes, untar con aceite, huevo batido, almíbar, etc.
- No absorben olores ni sabores.

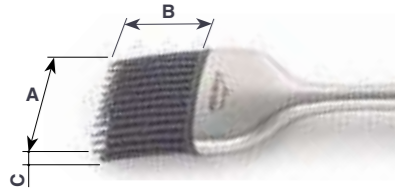

Mango de polipropileno  
Polypropylene handle



**Pincel VIROLA**  
Pinceau · Silikonpinsel  
Brush · Pincel

Ref	€	A (cm)	B (cm)	C (cm)	L (cm)	U.Venta
64430	4,30	2,8	5,0	5,0	23,0	1
64435	5,00	3,2	5,5	7,0	24,0	1
64440	5,20	3,8	5,5	7,0	24,5	1
65044	6,40	4,2	6,5	8,0	25,0	1
65050	7,70	4,7	6,5	8,0	26,0	1

Dimensiones reales · Real dimensions

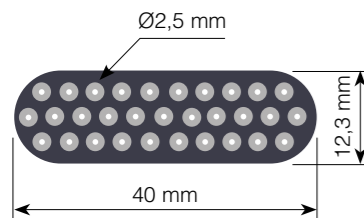

**Pincel de silicona MIX**  
Pinceau de cuisine en silicone · Silikonpinsel  
Silicone brush · Pincel de silicone

Ref	€	A (cm)	B (cm)	C (cm)	L (cm)	U.Venta
64431	7,20	3,8	4,0	1,0	24	12

FR

- Pour la cuisine ou la pâtisserie.
- Pratiques spatules ou langues de chats pour récupérer les éléments restant dans les bols, casseroles, etc.
- Pinceaux parfaits pour badigeonner de l'huile ou des sauces, mariner des viandes ou des poissons, graisser des moules, étaler de l'huile, de l'œuf battu, du sirop, etc.
- N'absorbent ni les odeurs ni les goûts.

EN

- For cooking or baking.
- Practical spatulas for scraping bowls, pots, dishes, etc.
- Brushes ideal for brushing oils or sauces, marinating meat or fish, greasing baking tins, and basting with oil, egg, syrup, etc.
- Doesn't absorb smells or tastes.



Inox 18/10

**Pincel de silicona PRO**  
Pinceau en silicone · Silikonpinsel  
Silicon brush · Pincel silicone

Ref	€	A (cm)	B (cm)	C (cm)	L (cm)	U.Venta
64418	10,80	4,0	4,0	1,4	22	1
64422	12,10	4,0	4,0	1,4	23	1



**Pincel de silicona**  
Pinceau en silicone · Silikonpinsel  
Silicon brush · Pincel de silicone

Ref	€	A (cm)	B (cm)	C (cm)	L (cm)	U.Venta
64441	6,70	5,8	3,4	1,7	23	1

Mango de Haya natural  
Natural beech handle



**Pincel UNITE**  
Pinceau · Silikonpinsel  
Brush · Pincel

Ref	€	A (cm)	B (cm)	C (cm)	L (cm)	U.Venta
68196	4,10	5,5	3,1	1,1	24,5	1

# RASQUETAS

## Colección



Diseño apilable  
Stackable design

**Rasqueta**  
Coupe pate · Schaber  
Scraper · Raspador

Ref	€	cm	U.Venta
67041	25,10	13,8x13	1

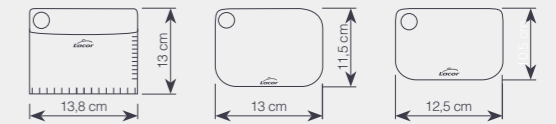

- El cortador de masa está fabricado en acero inoxidable de máxima calidad con escalas de medición tanto en cm como en in. Además, dispone de un mango antideslizante y ergonómico. Está diseñado para cortar, dividir y formar masas, así como recoger harinas, etc.
- Espátula de silicona exible de gran calidad y grado alimenticio. Ideal para el empleo en superficies poco uniformes, como boles esféricos.
- El raspador está fabricado en Polipropileno + Fibra de vidrio de grado alimenticio y diseñado principalmente para decorar tartas y pasteles de forma práctica y sencilla.

- Dough cutter made of top quality stainless steel with measurements marked in cm and inches. It has a non-slip ergonomic handle. It's designed to cut, divide and shape dough or pick up flour, etc.
- High quality flexible food safe silicone spatula, perfect for using on uneven surfaces like spherical bowls.
- Scraper made of food grade Polypropylene + Glass fiber mainly designed for decorating cakes and pies in a simple and easy way.



**Rasqueta INOX**  
Coupe pate · Schaber  
Scraper · Raspador

Ref	€	cm	U.Venta
A 67005	12,80	15x9	6
B 67006	12,40	15x9	6



Escala de medición  
Measurement scale

**Rasqueta INOX BLAK**  
Coupe pate · Schaber  
Scraper · Raspador

Ref	€	cm	U.Venta
67029	9,40	16,5x10,5	6



**Rasqueta FLEX**  
Coupe pate · Schaber  
Scraper · Raspador

Ref	€	cm	U.Venta
67414	8,90	9x15	1

# RODILLOS

## Colección

Inox  
18/10



(A) LONGITUD TOTAL - Total length  
(B) LONGITUD ZONA DE USO - Length area of use

ES

- Ideal para extender pequeñas cantidades de masa.
- Acabado uniforme para trabajar pastas, mazapán, fondant, etc.

FR

- Idéal pour étaler de petites quantités de pâte.
- Finition uniforme pour travailler des pâtes, du massepain, des fondants, etc.

EN

- Perfect for spreading small quantities of dough.
- Uniform nish when working with pastries, marzipan, fondant, etc.

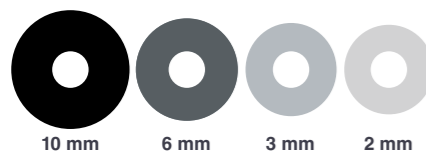

4 discos extraíbles · 4 removable discs



Guía para medir el ancho de la masa  
Guide to measure the width of the dough



HAYA  
Beech wood



Inox  
18/10

### Rodillo amasar con anillas

Rouleau hetre avec anneux · Teigrollen mit Ringen  
Rolling pin with guide rings · Rolo com anilhas

Ref	€	Anillas	L (cm)	Material	U.Venta
A 67142	15,30	10/6/2	38	HAYA	1
B 67143	15,90	10/6/3/2	38	INOX	1



### Rodillo

Rouleau patisier · Teigroller  
Rolling pin · Rolo

Ref	€	A (cm)	ØCxB (cm)	U.Venta
67140	42,00	40	Ø5x20	3
67148	46,80	48	Ø6,3x25	4
67156	50,00	56	Ø6,3x33	4
A 67149	48,60	48	Ø6,3x25	4
68153	11,00	50	30	1
68154	20,80	60	40	1
68142	9,70	43	Ø4,4	1
68150	10,20	50	Ø4,8	1
68141	35,60	43	Ø4,4	1
E 68151	43,50	50	Ø4,8	1

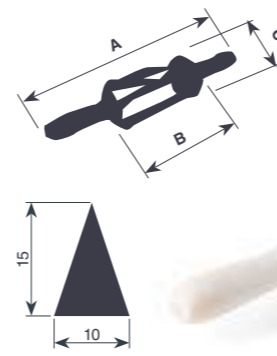

### Rodillo cortador croissant

Rouleau pour coupe croissant · Schneidewalze für Croissantteig  
Croissant dough cutter wheel · Rolo cortador de croissants

Ref	€	A (cm)	B (cm)	C (Ø cm)	U.Venta
68161	33,40	40,5	15,3	7,7	1



### Rodillo pica pasta

Rouleau pique vite pointe metal · Teig-Gitterschneider  
Roller docker metal · Rolo de pica massas

Ref	€	L (cm)	U.Venta
68213	36,40	13	6

New



ABS plastic PP Polypropylene

### Rodillo ROLLER

Rouleau patisier · Teigroller  
Rolling pin · Rolo

Ref	€	cm	L (cm)	U.Venta
A 68801	6,10	14	19,5	1
B 68802	6,10	14	19,5	1
C 68803	6,10	14	19,5	1
D 68804	6,10	12	19,5	1

- 68801: Corta con rapidez y precisión tiras de masa lisas y uniformes. Gracias a sus 9 ruedas extraíbles, podrás ajustar la anchura deseada.
- 68802: Diseñado para perforar cualquier tipo de masa (pasteles, quiches, hojaldres, pizza, etc.) Evita la formación de burbujas en las bases de masa durante el horneado.
- 68803: Corta con rapidez y precisión tiras de masa onduladas y uniformes. Gracias a sus 9 ruedas extraíbles, podrás ajustar la anchura deseada.
- 68804: Diseñado para formar una rejilla uniforme de pasta. Efecto simétrico enrejado, ideal para empanadas, pasteles de manzana, hojaldres, etc.
- Mango ergonómico
- Diseñado para todo tipo de masas. Deja volar tu imaginación.
- Mango ergonómico.
- Fácil limpieza, 100% desmontable y apto para el lavavajillas.
- Material: ABS y mango de polipropileno. Libre de BPA.

- 68801 : Coupez avec rapidité et précision des bandes de pâte lisses et uniformes. Grâce à ses 9 roulettes amovibles, vous pourrez régler la largeur souhaitée.
- 68802 : Conçu pour piquer tout type de pâte (tartes, quiches, feuilletés, pizza, etc.). Évite la formation de bulles sur la base des pâtes pendant la cuisson.
- 68803 : Coupez avec rapidité et précision des bandes de pâtes ondulées et uniformes. Grâce à ses 9 roulettes amovibles, vous pourrez régler la largeur souhaitée.
- 68804 : Conçu pour faire un dessus de treillis de pâte uniforme. Effet symétrique de losanges, idéal pour des empanadas, des tartes aux pommes, des feuilletés, etc.
- Conçu pour tout type de pâtes. Laissez libre cours à votre imagination.
- Manche ergonomique.
- Nettoyage facile, 100% démontable et apte pour le lave-vaisselle.
- Matériau : ABS et manche en polypropylène. Sans BPA.

- 68801: Quickly and accurately cuts smooth, even strips of dough. 9 removable cutting wheels allow you to adjust the desired width.
- 68802: Designed for poking holes (also referred to as 'docking') in any type of dough (cakes, quiches, puff pastry, pizza, etc.). Prevents formation of air bubbles in dough bases during baking.
- 68803: Quickly and accurately cuts uniform strips of dough into waves. 9 removable cutting wheels allow you to adjust the desired width
- 68804: Designed for creating a uniform lattice pattern. Symmetrical lattice effect, ideal for pastries, apple pies, puff pastry, etc.
- Designed for all types of dough. Let your imagination run wild!
- Ergonomic handle.
- Easy to clean, fully detachable and dishwasher safe.
- Material: ABS with polypropylene handle. BPA free



# SET CORTADORES

## Colección



Medidas - Sizes (cm):  
Ø2 / Ø3 / Ø4 / Ø5 / Ø6 / Ø7 / Ø8 / Ø9 / Ø10

### Caja de 9 cortapastas redondos

Boîte de 9 découpeurs ronds unis · 9 Tlg. Teigausstecher, rund, glatt  
Set of 9 round dough cutters · Caixa de 9 corta-massas ovais redondos

Ref	€	h (cm)	U.Venta	
68069	27,70	4,2	1	Liso · Pain
68070	30,10	4,2	1	Rizado · Fluted
68091	25,10	3,5	1	Liso · Pain
68092	25,10	3,5	1	Rizado · Fluted

- Set compuesto por 9 cortapastas redondos de Ø2-3-4-5-6-7-8-9-10 cm.
- Fabricados en acero inoxidable 18/10 de gran calidad.
- Ideales para repostería (pasteles, muffins, galletas, fondant, pan, gelatina, pancake, etc.).
- Aseguran un corte 100% preciso y seguro.
- Versátiles: se pueden usar como moldes para hojaldres o decoración de platos.
- Aptos para el lavavajillas.

- Ensemble de 9 découpeurs ronds Ø2-3-4-5-6-7-8-9-10 cm.
- Fabriqués en acier inoxydable 18/10 de haute qualité.
- Idéal pour la pâtisserie (gâteaux, muffins, biscuits, fondant, pain, gelée, crêpes, etc.)
- Ils garantissent une coupe précise et sûre à 100 %.
- Polyvalents : peuvent être utilisés comme moules pour la pâte feuilletée ou pour la décoration d'assiettes.
- Passent au lave-vaisselle.

- Set of 9 round dough cutters Ø2-3-4-5-6-7-8-9-10 cm.
- Made of high-quality 18/10 stainless steel.
- Ideal for baking (cakes, muffins, biscuits, fondant, bread, jelly, pancake, etc.).
- They ensure 100% accurate and safe cutting.
- Versatile: can be used as moulds for puff pastry or plate decoration.
- Dishwasher safe

Cerrado · Closed: 5,5x24 cm  
Abierto · Open: 49,5x24 cm  
Cuchillas · Blades: Ø5,5 cm



### Cortapastas extensible

Rouleau multicouper · Teigschneider  
Dough divider expandable · Corta-massas extensível

Ref	€	U.Venta
68246	51,10	1

New



### Set cortartartas

Jeu de découpeurs de gâteaux · Tortenausstecher-Set  
Cake cutter set · Conjunto de cortador de bolos

Ref	€	Ø (cm)	Ranuras	U.Venta
68527	13,90	24 - 30	6	1

- Set de tres utensilios para laminar todo tipo de tartas, bizcochos, etc.
- Fabricados en acero inoxidable de gran calidad. Resistentes y duraderos.
- El set incluye:
  - \* Aro ajustable con 6 ranuras que actúan de guía para cortar uniformemente tartas entre Ø 24-30 cm.
  - \* Cuchillo de hoja dentada diseñado para laminar fácilmente.
  - \* Pala para coger y servir de forma segura.

- Set de trois ustensiles pour laminer tous types de gâteaux, gâteaux, etc.
- Fabriqués en acier inoxydable de grande qualité. Résistants et durables.
- Le set inclut :
  - \* Cercle ajustable avec 6 rainures qui font office de guide pour découper uniformément les gâteaux de Ø 24-30 cm.
  - \* Couteau à lame dentée conçu pour laminer facilement.
  - \* Pelle à gâteau pour prendre la part et servir de façon sûre.

- Set of three utensils for layering all kinds of cakes.
- Made of high quality stainless steel, it is strong and durable.
- The set includes:
  - \* Adjustable ring with 6 grooves that work as guides for cutting cakes between Ø 24-30 cm.
  - \* Serrated knife designed to cut layers easily.
  - \* Spatula for picking up and serving the cake safely.



Incluye cortapastas  
Includes cookie cutter



### Sellos para galletas SWEET

Tampons pour biscuits · Keksstempel  
Biscuit stamp · Carimbos para bolachas

Ref	€	Sellos	U.Venta
68099	13,20	5	1

Dale un toque original · Add originality



- Conjunto de 5 originales sellos de silicona intercambiables.
- Mango de madera para un perfecto agarre.
- Silicona de máxima calidad. Libre de BPA.
- Garantiza la completa seguridad alimentaria del producto.

- Set de 5 tampons en silicona originaux interchangeables.
- Manche en bois pour une prise en main parfaite.
- Silicone de la plus grande qualité. Sans BPA.
- Garantit une sécurité alimentaire totale du produit.

- Set of 5 original interchangeable silicon stamp.
- Wood handle for perfect grip.



# ATEMPERAR

## Espátula



New

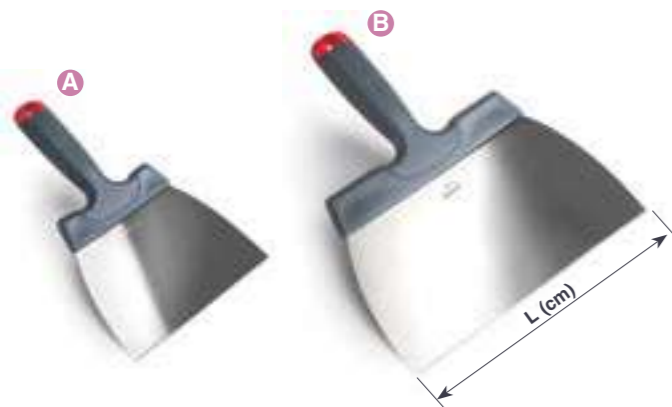

### Espátula para atemperar chocolate

Spatule pour tempérer le chocolat · Spatel zum Temperieren von Schokolade  
Chocolate tempering spatula · Espátula para temperar chocolate

	Ref	€	L (cm)	U.Venta
A	60533	6,80	16	1
B	60534	7,40	22	1

- Espátula profesional de acero inoxidable de máxima calidad, de grado alimenticio, resistente y duradero.
- Diseñado para templar chocolate recién fundido, glasear pasteles, galletas, pizzas, etc.
- Hoja superafilada trapezoidal semiflexible de 16 cm de ancho.
- Mango ergonómico y resistente, con orificio colgante.

- Spatule professionnelle en acier inoxydable de la plus grande qualité, à usage alimentaire, résistante et durable.
- Conçue pour le tempérage du chocolat fraîchement fondu, le glaçage des gâteaux, biscuits, pour les pizzas, etc.
- Feuille très aiguisée semi-flexible de 16 cm de largeur.
- Manche ergonomique et résistant, avec œillet de suspension.

- Professional spatula made of high quality, food-grade stainless steel, strong and durable.
- Designed for tempering freshly melted chocolate, glazing cakes, biscuits, pizzas, etc.
- Super-sharp, semi-flexible 16 cm wide trapezoidal blade.
- Sturdy, ergonomic handle with hanging hole.



# DECORACIÓN

## Peines · Estacas



### Rasqueta decoración

Grattoir à pâte · Teigschaber  
Dough scrape · Raspador de masa

Ref	€	mm	U.Venta
68132	1,70	155x105	24



### Peine decoración

Peigne de decoration · Verzierungskamm  
Decorating comb · Pente de decoração

Ref	€	mm	U.Venta
68136	1,50	110	24



### Juego peines decoración

Set peigne de decoration · Verzierungskamm-Set  
Decorating comb set · Jogo pente de decoração

Ref	€	Piezas	U.Venta
68137	5,80	7	1



### Estacas decoración FONDANT

Outils de modelisation · Modellierset  
Modeling tools · Ferramentas demodelagen

Ref	€	Piezas	U.Venta
68090	11,20	12	1

# DECORACIÓN

## Aerógrafo con compresor



ES

- Ideal para la decoración de tartas, galletas, cupcakes, bombones, etc.
- Permite obtener detalles únicos en creaciones artísticas de repostería.
- El kit contiene: compresor, aerógrafo y tubo conector.
- Compresor con regulador de presión de aire.
- 0-2 bares y con un caudal de 0-10 L/min.
- Aerógrafo por gravedad de doble acción con aguja de salida de 0,3 mm.
- Depósito de pintura metálico con capacidad de 7 ml.
- Incluye una caja acolchada para almacenar el aerógrafo.

FR

- Idéal pour la décoration de gâteaux, biscuits, cupcakes, chocolats, etc.
- Permet d'obtenir des détails uniques sur des créations artistiques de pâtisserie.
- Le kit contient : compresseur, aérographe et tuyau connecteur.
- Compresseur avec régulateur de pression d'air.
- 0-2 bars et avec un débit de 0-10 L/min.
- Aérographe par gravité à double action avec aiguille de sortie de 0,3 mm.
- Réservoir de peinture métallique d'une capacité de 7 ml.
- Inclut une boîte matelassée pour ranger l'aérographe.

EN

- Perfect for decorating cakes, biscuits, cupcakes, bonbons, etc.
- Lets you get unique details on artistic bakery creations.
- The set contains: Compressor, airbrush and air hose.
- Compressor with air pressure regulator.
- 0-2 bars with a 0-10 L/min flow.
- Double action gravity feed airbrush with a 0.3 mm needle.
- Metal paint cup with a 7 ml capacity.
- Includes a padded box for storing the airbrush.



### Aerógrafo con compresor

Aérographe avec compresseur · Airbrush Spritzpistole mit Kompressor  
Airbrush with compressor · Aerógrafo com compressor

Ref	€	W	Presión	Caudal	U.Venta
69450	103,20	20	0 - 2 bar	0 - 10 L/min	1

### Características · Characteristics:

- Referencia · Reference: 69450
- Tensión · Voltage: 220-240 V; 50 Hz
- Potencia · Power: 20 W
- Presión · Pressure: 0 - 2 bar
- Caudal aire · Air flow: 0 - 10 L7min
- Capacidad · Capacity: 7 ml
- L tubo · tube: 1,80 m
- Aerógrafo · Airbrush: 14,2x2,5x9 cm
- Compresor · Compressor: 11,5x13,5x6 cm
- Peso · Weight: 800 g



# PISTOLAS · SOPLETES GAS

## Colección

Inox 18/10 CE



ES

- Autoencendido por piezoeléctrico.
- Control ajustable de llama.
- Llama antiretorno.
- Sistema seguro de bloqueo.
- Fácil rellenado de gas butano.

FR

- Auto-allumage par piézoélectrique.
- Contrôle de flamme réglable.
- Flamme antiretour.
- Système de blocage sécurisé.
- Facile remplissage de gaz butane.

EN

- Auto power by piezoelectric sensor.
- Adjustable flame control.
- Non-return flame.
- Safe stop system.
- Easy filling of butane gas.



Válvula recarga gas  
Refill valve



### Pistola gas repostería

Torche à caraméliser · Gasbrenner  
Pastry gas torch · Queimadora a gás para pastelaria

	Ref	€	Cap. (ml)	h (cm)	U.Venta	
A	68981	18,90	5-6	12,50	1	Micro
B	68982	30,70	19	17,00	1	Mini
C	68983	41,80	65	18,00	1	Chef
D	68988	53,20	40	16,00	1	Profesional
E	68969	22,10	21	13,00	1	Burn

Cuando el orificio de entrada de oxígeno este descubierto, la llama será más intensa

When the oxygen inlet is uncovered, the flame will be more intense



Adaptador para poder utilizar distintos tipos de botellas de gas  
Adapter enables it to be used with different types of gas bottles



Botella de gas NO incluida  
Gas of bottle NOT included

### Cabezal soplete gas + adaptador PROFESIONAL

Torche à caraméliser + adaptateur · Gasbrenner-Aufsatz + Adapter  
Blow torch head + adapter · Queimadora a gás + adaptador

Ref	€	W	Consumo (g/h)	U.Venta
68974	25,20	1,65	120	1



Botella de gas NO incluida  
Gas of bottle NOT included

### Cabezal soplete gas PROFESIONAL

Torche à caraméliser · Gasbrenner-Aufsatz  
Blow torch head · Queimadora a gás

Ref	€	W	Consumo (g/h)	U.Venta
68984	16,30	1,65	120	1



GAS  
No incluido  
Not included

Válido para gas butano, NO gas natural  
Valid for butane gas, NOT natural gas

### Soplete gas PROFESIONAL

Torche à caraméliser · Brullierbrenen  
Blow torch · Queimador a gás

Ref	€	Kw	Temp.	g/h	U.Venta
68968	31,00	1,7	1300°C	123	1



Incluye soporte  
Includes support

### Queimador eléctrico redondo

Fer à caraméliser électrique rond · Karamellisierer rund  
Round electric caramelizer · Queimador eléctrico redondo

Ref	€	U.Venta
68651	114,70	1
68652	132,40	1

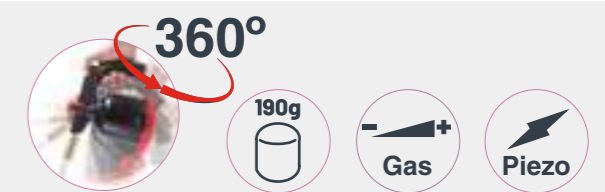

- Recargable con cartuchos universales de gas tipo C200 (190g). (No incluido).
- Encendido piezoeléctrico.
- Flujo ajustable.
- Función de precalentamiento integrada que garantiza una configuración de llama óptima.
- Sistema 360°; permite el uso en cualquier posición y siempre con llama constante.
- Sistema de bloqueo de seguridad.
- Mango ergonómico de polipropileno resistente a altas temperaturas y golpes.

- Refillable with universal type C200 (190 g ) gas cartridges (not included).
- Piezoelectric ignition.
- Adjustable flow.
- Built in pre-heating function that guarantees optimal flame configuration.
- The 360° System lets you use the torch in any position and always with a constant flame.
- Safety locking system.
- Ergonomic polypropylene handle that can withstand high temperatures and impacts.

- Fabricada en acero inoxidable 18/10 con mango de plástico negro de excelente calidad.
- Diseñado para aplicaciones en cocina y repostería.
- Consta de una resistencia, que al conectarse a la corriente, se calienta.
- Incluye soporte.

- Made of 18/10 stainless steel with a high quality black plastic handle.
- Designed for cooking and baking applications.
- Consists of a heating element, which heats up when connected to the mains.
- Includes stand

#### Características · Characteristics:

Referencia · Reference: 68651  
Tensión · Voltage: 220-230 V; 50 Hz  
Potencia · Power: 650 W  
Dimensiones · Sizes: Ø10 cm  
Peso · Weight: 1,132 Kg

Referencia · Reference: 68652  
Tensión · Voltage: 220-230 V; 50 Hz  
Potencia · Power: 1000 W  
Dimensiones · Sizes: Ø12 cm  
Peso · Weight: 1,268 Kg



# DOSIFICADORES

## Colección

Inox  
18/10  
Dishwasher



Salado · Salty



Dulce · Sweet

ES

- Ideal para rellenar o decorar platos con salsas y cremas calientes y frías.
- Sistema de palanca para un caudal ajustable; práctico y preciso.
- Sistema antigoteo y antisalpicaduras.
- Mango con diseño ergonómico que permite el manejo con una sola mano.
- Fácil desmontaje para una sencilla limpieza. Apto para el lavavajillas.

FR

- Idéal pour remplir ou décorer des assiettes avec des sauces chaudes et froides.
- Système de piston pour un débit ajustable ; pratique et précis.
- Système anti-goutte et anti-éclaboussures.
- Manche ergonomique qui permet de le manipuler d'une seule main.
- Facile à démonter pour un nettoyage aisé, et apte pour le lave-vaisselle.

EN

- Perfect for filling or decorating dishes with hot or cold sauces and cream.
- Its lever system for controlling the flow is practical and precise.
- Anti-drip and anti-splash system.
- The ergonomic handle means it can be used with just one hand.
- It's easy to disassemble for easy cleaning and it's dishwasher safe.

Si PS BPA free



Marcas de medición  
(ml - cup)  
Measuring marks  
(ml - cup)

### Dosificador

Entonnoir à decor · Dosierer  
Portionner · Dosificador

Ref	€	cm	h (cm)	L	U.Venta
67026	11,80	16x11	18	1,0	1



Incluye soporte y un  
platinillo antigoteo  
Includes support  
and a drip dish

### Dosificador INOX

Entonnoir à decor · Dosierer  
Portionner · Dosificador

Ref	€	Ø (cm)	h (cm)	L	U.Venta
67150	61,60	19	27	2,0	1
R67150B	19,90	4/6/8			1

Set 3 boquillas  
Set 3 nozzles



Salado · Salty



Dulce · Sweet

Sistema de gatillo para un caudal ajustable  
Trigger system for an adjustable flow



3  
Boquillas  
Nozzles

### Dosificador RATION

Entonnoir à decor · Dosierer  
Portionner · Dosificador

Ref.	€	L	U.Venta
67000	88,60	2,00	1



### Cono

Cône · Trichter  
Cone · Cone

Ref.	€	L	U.Venta
R67000	39,30	2,00	1

Diseño premiado en certámenes internacionales  
Award-winning design in international competitions

ASA BPA free



### Soporte mango

Support · Stütze  
Support · Suporte cabo

Ref.	€	U.Venta
R67001	35,40	1



### Base negra

Base noire · Ständer, schwarz  
Black base · Base negra

Ref.	€	U.Venta
R67002	13,90	1



### Boquillas

Douille · Düse  
Nozzle · Boquilhas

	Ref.	€	Ø (mm)	U.Venta
A	R67003	1,60	1	1
B	R67004	1,80	4	1
C	R67005	1,80	6	1
D	R67006	1,80	8	1

# SIFONES

## Colección



EXCLUSIVAMENTE PARA USO ALIMENTICIO  
EXCLUSIVELY FOR FOOD USE



### Cargas sifón N2O

Cartouches N<sub>2</sub>O pour siphon · N<sub>2</sub>O Kapsel für Sahnbereiter  
N<sub>2</sub>O cream charger · Botijas de sifão N<sub>2</sub>O

Ref	€	Botellas	g	U.Venta
68402	8,30	10	8	1
68403	19,40	24	8	1

**APTO SOLAMENTE PARA MEZCLAS FRIAS Y TEMPLADAS (<40°C)**  
À UTILISER UNIQUEMENT POUR LES MÉLANGES FROIDS ET TEMPLÉS (<40°C)  
ONLY SUITABLE FOR COLD AND TEMPERED MIXTURES (<40°C)

**New**

### Sifón EPICURE

Siphon à crème · Sahnebereite  
Cream whipper · Sifão creme

Ref	€	Ø (cm)	L	U.Venta
68300	104,70	9,0	0,50	1
68301	118,90	9,0	1,00	1

Temperatura de uso · Use temperature  
min = +5°C / max = +70°C



- Cuerpo y cabezal fabricado en acero inoxidable 18/10 de gran calidad.
- Marcaje de llenado grabado en el exterior del cuerpo.
- Versátil: Diseñado para espumas frías y espumas calientes.
- Incluye 3 boquillas de acero inoxidable con formas decorativas.
- Funciona con cargas de gas (N<sub>2</sub>O).
- Cepillo limpiador para facilitar la limpieza. Apto para el lavavajillas.

- Corps et tête fabriqués en acier inoxydable 18/10 de grande qualité.
- Marquage de remplissage gravé à l'extérieur du corps.
- Versatile : conçu pour des préparations froides et chaudes.
- Inclut 3 douilles en acier inoxydable avec des formes décoratives.
- Fonctionne avec des cartouches de gaz (N<sub>2</sub>O).
- Brosse pour faciliter le nettoyage. Compatible avec le lave-vaisselle.

- Top-quality 18/10 stainless steel body and head.
- Embossed filling marks on the outside.
- Versatile: designed for whipping up hot or cold foams.
- Includes 3 stainless steel nozzles with decorative shapes.
- Charged with gas cartridges (N<sub>2</sub>O).
- Cleaning brush for easy cleaning. Dishwasher safe.



### Sifón MIX

Siphon à crème · Sahnebereite  
Cream whipper · Sifão creme

Ref	€	Ø (cm)	L	U.Venta
68404	100,00	7,8x25	0,50	1
68405	114,90	9,3x32,5	1,00	1

Temperatura de uso · Use temperature  
min = +5°C / max = +40°C



### Sifón WHITE

Siphon à crème · Sahnebereiter  
Cream whipper · Sifão creme

Ref	€	Ø (cm)	L	U.Venta
68502	40,60	9x27	0,25	1
68500	48,10	9x31	0,50	1
68501	53,60	11x36	1,00	1

Temperatura de uso · Use temperature  
min = +5°C / max = +40°C



### Sifón BLACK

Siphon à crème · Sahnebereiter  
Cream whipper · Sifão creme

Ref	€	Ø (cm)	L	U.Venta
68604	50,70	7,8x27,3	0,50	1
68605	55,90	9,3x32,5	1,00	1

Temperatura de uso · Use temperature  
min = +5°C / max = +40°C

# MANGAS REPOSTERÍA

## Colección



ES

- Mangas pasteleras para decorar y personalizar tus postres preferidos.
- Mangas de alta calidad, soportan altas temperaturas, resistentes y reutilizables.
- Aptas para el lavavajillas.

FR

- Poche à douille pour décorer et personnaliser vos desserts préférés.
- Poche de grande qualité, supporte des températures élevées, résistante et réutilisable.
- Compatible avec le lave-vaisselle.

EN

- Pastry bag to decorate and customise your favourite desserts.
- Bag of high-quality withstands high temperatures and is durable and reusable.
- Dishwasher safe.

### Manga repostería

Poche à décorer · Spritzbeutel  
Pastry bag · Manga de pastelería

Ref	€	cm	Ø (cm)	U.Venta
A 68972	7,30	20	20x30	1
B 68973	12,40	30	25x45	1



Se adaptan a cualquier tipo de boquilla  
Adapts to any kind of nozzle

Se adaptan a cualquier tipo de boquilla  
No emplear con alimentos a temperaturas superiores a 60°C  
Adapts to any kind of nozzle  
Not for use with food at temperatures above 60°C



### Manga repostería nylon

Poche à décorer en nylon · Nylon Spritzbeutel  
Nylon pastry bag · Manga de pastelería de nylon

Ref	€	ml	h (cm)	U.Venta
68971	7,60	800	30	1



Boca · Mouth: Ø2,5 cms.

### Mangas desechables

Poche à décorer jetable · Einweg Spritzebeutel  
Non-returnable pastry bags · Mangas descartables

Ref	€	h (cm)	L	U.Venta
68930	5,10	30	0,57	6
68935	6,00	35	1,10	6
68940	6,60	40	1,45	6
68945	7,80	45	2,30	6
68950	8,60	50	2,50	6
68955	9,50	55	3,40	6
68960	10,70	60	5,50	6
68965	11,20	65	6,50	6
68970	13,50	70	7,50	6



Galga 280 = 70 micras (µm)

Ref	€	Cantidad	AxB (cm)	U.Venta
68937	14,60	100	35x21	1
68939	21,00	100	40x22	1
68954	31,50	100	55x30	1
68964	36,90	100	65x32	1



NUNCA ponga los sifones al baño maría, puede producirse una explosión con graves consecuencias.  
NE JAMAIS mettre les siphons au bain marie car une explosion pourrait avoir lieu et provoquer de graves conséquences.  
NEVER put siphons in a water bath, as this may cause an explosion with serious consequences.

# BOQUILLAS

## Colección

Inox  
18/10  
Dishwasher



ES

- Fabricadas en acero inoxidable 18/10.
- Excelente resistencia a la corrosión y a los ácidos alimentarios y sales.
- Adaptables a las mangas de repostería.
- Distintas formas para decorar postres.

FR

- Fabriquées en acier inoxydable 18/10.
- Excellente résistance à la corrosion et aux acides et sels alimentaires.
- Adaptables sur les poches à douilles de pâtisserie.
- Différentes formes pour décorer les desserts.

EN

- Made of 18/10 stainless steel.
- Excellent resistance to corrosion and to food acids and salts.
- Can be adapted to piping bags.
- Different shapes for decorating desserts.



### Set de 6 boquillas redonda

Ensemble 6 douilles unies · Lochtüllensatz 6-tlg. rund  
6 plain tube set · Conjunto de 6 boquillas redondas

Ref	€	Ø (mm)	U.Venta
68908	25,40	8	1
68910	25,40	10	1
68912	25,40	12	1
68915	25,40	15	1



### Set de 6 boquillas estrella

Ensemble 6 douilles cannelées · Lochtüllensatz 6-tlg. Stern  
6 star tube set · Conjunto de 6 boquillas estrella

Ref	€	Ø (mm)	U.Venta
68928	25,40	8	1
68900	25,40	10	1
68932	25,40	12	1
68934	25,40	15	1



### Set de 6 boquillas rosa

Ensemble 6 douilles cannelées fermes · Tüllensatz  
6-tlg. Stern, geschlossen  
6 close star tube set · Conjunto de 6 boquillas rosa

Ref	€	Ø (mm)	U.Venta
68948	25,40	8	1
68980	25,40	10	1
68942	25,40	12	1
68985	25,40	15	1



### Set de 6 boquillas redonda

Ensemble 6 douilles unies · Lochtüllensatz 6-tlg. rund  
6 plain tube set · Conjunto de 6 boquillas redonda

Ref	€	Forma (mm)
68996	16,60	Redonda 4/5/6/8/10/12



### Set de 6 boquillas estrella

Ensemble 6 douilles cannelées · Tüllensatz 6-tlg., Stern  
6 star tube set · Conjunto de 6 boquillas estrella

Ref	€	Forma (mm)
68997	16,60	Estrella 4/5/6/8/10/12



### Set de 6 boquillas rosa

Ensemble 6 douilles cannelées fermes · Tüllensatz  
6-tlg. Stern, geschlossen  
6 close star tube set · Conjunto de 6 boquillas rosa

Ref	€	Forma (mm)
68993	16,60	Rosa 4/6/8/10/12/15



### Set de 6 boq. variadas

Ens. 6 douilles variées · Tüllensatz 6-tlg.  
6 assorted tube set · Conjunto de 6 boquillas variadas

Ref	€	Forma (mm)
68998	16,60	Rosa 6/8 Cinta 20x3 Hélice 5 Estrella 6/9/13



### Set de 6 boquillas variadas

Ensemble 6 douilles variées · Tüllensatz 6-tlg. assorti  
6 assorted tube set · Conjunto de 6 boquillas variadas

Ref	€	Forma (mm)
68999	16,60	Rosa 6/8 Hélice 5 Estrella 6/9/13

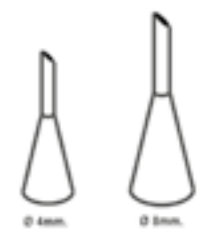

### Set de 2 boquillas relleno

Ensemble 2 douilles petit chou · Einfülltüllensatz 2-tlg.  
2 Bismark tube set · Conjunto de 2 boquillas relleno

Ref	€	Forma (mm)
68992	10,90	Relleno 4/8

### Juego 6 boquillas rusas

Ensemble 6 douilles russes · 6-Tlg Russian Tüllensatz  
Set 6 Russian decorating nozzles · Conjunto 6 boquillas ruso

	Ref	€	Ø (cm)	h (cm)	Unidades	U.Venta
A	68892	8,40	3,5	4,5	6	6
B	68893	14,50	3,0	6,2	6	1



### Juego de boquillas decoración

Deuilles assorties décoration · Dekorations-Tüllensatz  
Decorating nozzles · Jogo de boquillas decoração

Ref	€	Piezas	U.Venta
68991	16,50	26	1



### Set 24 pcs. boquillas

24 pcs. douilles assorties · 24 tlg. Tüllensortiment  
24 pcs. anozzles set · Conjunto de 24 boquillas

Ref	€	Piezas	U.Venta
68994	15,20	24	1

# REPOSTERÍA

Pistolas · Botellas biberón



ES

- Ideales para salsas, cremas, aceites, aliños, vinagretas y todo tipo de condimentos líquidos.
- Dibuja, adorna y personaliza con estilo tus platos.

FR

- Idéal pour les sauces, les crèmes, les huiles, les assaisonnements, les vinaigrettes et tout type de condiments liquides.
- Il dessine, décore et personnalise les plats.

EN

- Ideal for sauces, creams, oils, dressings, vinaigrettes and all kinds of liquid condiments.
- Draw, decorate and personalize your dishes with style.



## Pistola decoración repostería

Pistolet Décoration Pâtisserie · Pistole für Tüllensätze  
Pastry Decoration Gun · Pistola Decoração Pastelaria

Ref	€	L	U.Venta
61407	32,60	0,25	1



## Botella biberón

Bouteille biberon · Dosierflasche  
Squeeze bottle · Garrafa

Ref	€	Ø (cm)	L	U.Venta
61974	4,00	7x20	0,47	6
61977	4,30	7x26	0,71	6



## Botella biberón PUSH

Bouteille biberon · Dosierflasche  
Squeeze bottle · Garrafa

Ref	€	Ø (cm)	L	U.Venta
61978	4,50	6x20	0,50	1
61979	4,60	7x20	0,60	1
61980	4,80	7x26	0,70	1



## Biberón decoración

Biberon à décorer · Dekorierflasche  
Decorating pen · Garrafa decoração

Ref	€	Ø (cm)	L	U.Venta
64457	9,50	5,5x16	0,14	1



Click here



## Juego pistola repostería

Pistolet pour pâtisserie · Pistole für Tüllensätze  
Cookie press cum icing set · Jogo de pistola pastelaria

Ref	€	L	U.Venta
68989	48,10	0,25	1

# BAÑOS MARIA CHOCOLATE

Colección

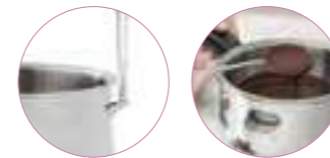

Abertura lateral para llenar de agua (1,0 L)  
Capacidad chocolate: 1,0 L  
Side opening to introduce water (1,0 L)  
Chocolate capacity: 1,0 L



## Cazo baño maría

Casserole bain marie · Stielkasserolle für Wasserbad  
Bain-marie saucepan · Caçarol para banho-maria

Ref	€	Ø (cm)	h (cm)	L	U.Venta
62600	29,90	16	10,0	1,00	1



## Baño maría chocolate BLACK

Bain marie de chocolat · Bain Marie topf für Schokolade  
Chocolate bain marie · Banho-maria chocolate

Ref	€	W	U.Venta
69317	41,70	50	1

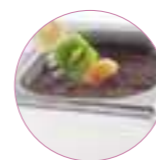

## Baño maría chocolate WHITE

Bain marie de chocolat · Bain Marie topf für Schokolade  
Chocolate bain marie · Banho-maria chocolate

Ref	€	W	U.Venta
69617	75,50	80	1



- Cazo de doble pared para cocinar al baño maría.
- Fabricado en acero inoxidable 18/10 de máxima calidad.
- Doble pared: evita que el agua entre en contacto con el alimento.
- Abertura en el lateral para un llenado práctico y cómodo.
- Ideal para derretir chocolate, caramelo, emulsionar salsas, fundir mantequilla, etc.
- Mango de baquelita termorresistente.
- Apto para todos los fuegos (incluido la inducción).
- Fácil de usar y limpiar. Se puede lavar en lavavajillas.

- Double-walled saucepan for bain-marie cooking.
- Made of top quality 18/10 stainless steel.
- Double wall: prevents the water from coming into contact with the food.
- Convenient, easy-to-fill opening on the side.
- Ideal for melting chocolate, caramel, for blending sauces, melting butter, etc.
- Heat-resistant Bakelite handle.
- Suitable for all sources of heat, including induction.
- Easy to use and clean. Dishwasher safe.

- Cazo desmontable de acero inoxidable 18/10 de gran calidad
- Preparar fácilmente coberturas para sus postres.
- Permite fundir chocolate y mantenerlo caliente
- Puede añadirle especias (canela, jengibre en polvo, pimentas, vainilla) para un chocolate más intenso.

- High quality 18/10 st. steel collapsible pan
- Easily prepare toppings for your desserts.
- It allows you to melt chocolate and keep it hot
- You can add spices (cinnamon, ginger powder, peppers, vanilla) for a more intense chocolate.

### Características · Characteristics:

Referencia · Reference: 69317  
Tensión · Voltage: 230-240 V; 50 Hz  
Potencia · Power: 50 W  
Temperatura · Temperature: 40°C - 50°C  
Capacidad · Capacity: 1,0 L  
Dimensiones · Sizes: 29x22x12 cm  
Peso · Weight: 0,875 Kg

- Perfecta para elaborar coberturas de alta calidad y mantenerlas a la temperatura deseada durante horas.
- Ideal para la obtención de un glaseado brillante para pasteles, tartas, cake pops, muffins, etc.
- Contenedor GN1/6 (1,50L) y tapa extraíble de acero inoxidable 18/10 para garantizar una rápida y efectiva limpieza (aptos para el lavavajillas).
- Calentamiento 3D; el calor se distribuye de manera uniforme por toda la superficie del recipiente.
- Compatible con cubetas GN1/6 de Lacor.

- Perfect for making high quality toppings and keeping them at the desired temperature for hours
- Ideal for getting shiny glazing on pies, cakes, cake pops, muffins, and more
- It has a GN1/6 (1.5 L) container and removable 18/10 stainless steel lid to make cleaning fast and effective. Dishwasher safe.
- 3D Heating: Heat is distributed evenly over the entire surface of the container.
- It's compatible with GN1/6 pans from Lacor.

### Características · Characteristics:

Referencia · Reference: 69617  
Tensión · Voltage: 230-240 V; 50 Hz  
Potencia · Power: 80 W  
Temperatura · Temperature: 0°C - 50°C  
Capacidad · Capacity: 1,5 L  
Dimensiones · Sizes: 22,5x26x14,5 cm  
Peso · Weight: 1,250 Kg

# REPOSTERÍA

## Utensilios

Inox  
18/10  
Dishwasher



Acero cromado  
Chrome steel

- Rejillas de alambre resistentes para dejar reposar los postres recién sacados del horno o cubrir de chocolate o azúcar glas.
- Fabricadas en acero cromado para una larga duración.
- Permite enfriar homogéneamente todas las partes del postre incluida la parte inferior.
- Protegen las superficies de la cocina de quemaduras.
- No se recomienda su uso en el lavavajillas.

- Grilles de refroidissement en métal pour laisser reposer les desserts fraîchement sortis du four ou les napper de chocolat ou de sucre glace.
- Fabriquée en acier chromé pour une grande durabilité.
- Permet de refroidir de façon homogène toutes les parties du dessert, y compris la partie inférieure.
- Protège les surfaces de la cuisine des brûlures.
- Lavage au lave-vaisselle déconseillé.

- Resistant wire rack for cooling freshly baked desserts or covering them in chocolate or sugar glass.
- Made of chrome steel for a long life.
- Allows all parts of the dessert to cool evenly, including the bottom.
- Protects kitchen surfaces from burns.
- Dishwasher not recommended.

### Rejilla para repostería

Grille pâtisserie · Kuchengitter rund  
Pastry rack · Grelha para pasteleria

Ref	€	Ø (cm)	U.Venta
66916	6,20	28	6
66926	6,30	32	6
66917	8,30	36	6
66927	8,50	43x30	6



ME  
Melamine



PP  
Polipropileno

Situar · Marcar · Repartir  
Place · Mark · Partitioning

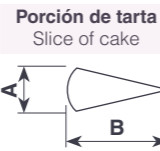

Porción de tarta  
Slice of cake

### Marcador de tartas

Marqueur à gateaux · Tortenteiler  
Cake marker · Marcador de bolos

Ref	€	Ø (cm)	Porciones	AxB (cm)	U.Venta
68511	8,80	27	10 / 12	8,5x13,5 / 7,5x13,5	1
68513	8,80	27	14 / 16	6x13,5 / 5,5x13,5	1

### Portartas

Gueridon pâtisier · Kuchenplatte  
Cake stand · Porta-tartes

Ref	€	Ø (cm)	U.Venta
67030	173,40	30	1
63586	32,50	30x9	4



### Pinza repostería

Pince à gâteau · Gebäck-Tortenzange  
Cake tong · Pinça pastelaria

Ref	€	L (cm)	U.Venta
62317	11,70	20	1
68008	5,90	16	6

New

Diseñada para coger galletas  
Flexible  
No raya  
Designed to pick up biscuits  
Flexible  
Non-scratch

### Espátula para galletas TASTY

Spatule à biscuits · Spachtel für Kekse  
Biscuit spatula · Espátula para biscoitos

Ref	€	cm	L (cm)	U.Venta
68805	5,00	16,8x11	32,5	1



Inox

PA  
Nylon

# RACIONADORES HELADO

## Colección

Inox  
18/10  
Dishwasher



ES

- Utensilio de repostería perfecto para formar bolas de helado sin esfuerzo.
- Mecanismo de estilo guillotina para extraer y servir fácilmente bolas de helado.
- Gran resistencia y durabilidad.
- Fácil de usar y limpiar. Apto para lavavajillas.

FR

- Ustensile de pâtisserie parfait pour faire des boules de glace sans efforts.
- Mécanisme de style guillotine pour extraire et servir facilement les boules de glace.
- Grande résistance et durabilité.
- Facile à utiliser et à nettoyer. Apte pour le lave-vaisselle.

EN

- A perfect confectionery utensil for making balls of ice cream effortlessly.
- Guillotine style mechanism for easily scooping and serving balls of ice cream.
- Very strong and durable.
- Easy to use and clean. Dishwasher safe.



Fundición de inoxidable  
Stainless cast iron

### Racionador PROFESIONAL

Cuillère à glace professionnel · Eisportionierer, Profi  
Professional ice cream scoop · Racionador profesional

Ref	€	Bolas/L	Ø (mm)	U.Venta
67038	33,50	50	39	10
67043	33,50	40	44	10
67045	34,40	36	46	10
67047	34,40	30	48	10
67049	34,40	24	50	10
67052	35,60	20	53	10
67055	35,60	16	56	10
67058	35,60	13	59	10
67062	35,60	12	63	10
67065	35,60	10	66	10
67069	35,70	8	70	10
67074	35,70	7	75	10
67084	35,70	5	85	10



Fundición de inoxidable  
Stainless cast iron

### Racionador oval PROFESIONAL

Cuillère à glace ovale · Eisportionierer  
Ice cream scoop oval · Racionador oval

Ref	€	Bolas/L	mm	U.Venta
67153	35,40	40	53x41	10
67158	35,40	30	58x48	10
67163	35,40	20	63x48	10



### Racionador BASIC

Cuillère à glace · Eisportionierer  
Ice cream scoop · Racionador de gelado

Ref	€	Bolas/L	Ø (mm)	U.Venta
67039	17,80	50	39	10
67044	17,80	40	44	10
67046	17,80	36	46	10
67048	17,80	30	48	10
67050	17,80	24	50	10
67053	18,10	20	53	10
67056	18,80	16	56	10
67059	18,80	13	59	10
67063	18,80	12	63	10
67066	19,20	10	66	10
67070	19,20	8	70	10



PA Nylon  
Fibra de vidrio Fibreglass  
BPA free

### Racionador helado WHITE

Cuillère à glace · Eisportionierer  
Ice cream scoop · Racionador de gelado

Ref	€	Bolas/L	Ø (mm)	U.Venta
67040	9,40	24	50	12

- Utensilio de repostería perfecto para formar bolas de helado sin esfuerzo.
- Diseño original, ergonómico y muy ligero.
- Fabricado en nylon y fibra de vidrio. Libre de BPA.
- Mecanismo de estilo guillotina para extraer y servir fácilmente bolas de helado.
- Cuchara de 5 cm de diámetro, 24 bolas/L de capacidad.
- Gran resistencia y durabilidad.
- Fácil de usar y limpiar. Apto para lavavajillas.

- Ustensile de pâtisserie parfait pour faire des boules de glace sans efforts.
- Conception originale, ergonomique et très légère.
- Fabriqué en nylon et fibre de verre. Sans BPA.
- Mécanisme de style guillotine pour extraire et servir facilement les boules de glace.
- Cuillère de 5 cm de diamètre, capacité de 24 boules/L.
- Grande résistance et durabilité.
- Facile à utiliser et à nettoyer. Apte pour le lave-vaisselle.

- A perfect confectionery utensil for making balls of ice cream effortlessly.
- The design is original, ergonomic and very light weight.
- Made of Nylon and fiberglass BPA free.
- Guillotine style mechanism for easily scooping and serving balls of ice cream.
- 5 cm diameter spoon, 24 balls/L capacity.
- Very strong and durable.
- Easy to use and clean. Dishwasher safe.



### Racionador de helado PRO

Cuillère à glace · Eisportionierer  
Ice cream scoop · Racionador de gelado

	Ref	€	L (cm)	Color	U.Venta
A	67091	9,20	26,5	Azul · Blue	1
B	67092	9,20	26,5	Naranja · Orange	1
C	67093	9,20	26,5	Rojo · Red	1
D	67094	9,20	26,5	Verde · Green	1
E	67095	9,20	26,5	Transparente · Transparent	1

SAN plastic  
BPA free

- Cucharas para servir helado. Fabricadas en acero inoxidable 18/10 de máxima calidad.
- Mango ergonómico en plástico SAN, diseño antideslizante.
- Disponible en diferentes colores; azul, naranja, rojo, verde y transparente.

- Cuillères pour servir la glace. Fabriquées en acier inoxydable 18/10 de grande qualité.
- Manche ergonomique en plastique SAN, conception antidérapante.
- Disponible en différentes couleurs : bleu, orange, rouge, vert et transparente.

- Spoons for serving ice cream. Made of 18/10 top quality stainless steel.
- Ergonomic SAN plastic handle, non-slip design.
- Available in different colours: Blue, orange, red, green and transparent.



AL Aluminum

### Racionador helado aluminio

Cuillère à glace aluminium · Eisportionierer, Aluminium  
Aluminium ice cream scoop · Racionador de gelado aluminio

Ref	€	Bolas/L	Ø (mm)	ml	L (cm)	U.Venta
67090	9,60	50	50	12	18	1



### Copa baja

Coupe à glace basse · Eiskelch  
Ice cream cup · Taça de gelado

Ref	€	Bolas/L	cm	U.Venta
67002	4,80	5,5	Ø9x12	12

Moldes - Aros  
Moulds - Cake rings

# BLACK

## Colección moldes



### ES

- Amplia gama de moldes de silicona para procesos de horneado y congelación.
- Antiadherentes, flexibles, duraderos, higiénicos y fáciles de limpiar.
- Soportan fuertes cambios de temperatura.
- No transmiten sabores ni olores.
- Permiten desmoldar fácil y perfectamente los alimentos.

### FR

- Large gamme de moules en silicone pour enfourner et congeler.
- Antiadhésifs, flexibles, durables, hygiéniques et faciles à nettoyer.
- Supportent de fortes variations de température.
- Ne transmettent ni goûts ni odeurs.
- Permettent de démouler facilement et parfaitement les aliments.

### EN

- Wide range of silicone moulds for baking and freezing processes.
- Non-stick, flexible, long-lasting, hygienic and easy to clean.
- They can withstand drastic temperature changes.
- They do not transmit flavours or odours.
- Food can be de-moulded quickly and perfectly with them.

**Antiadherentes, flexibles, duraderos, higiénicos y fáciles de limpiar**  
Non-stick, flexible, long-lasting, hygienic and easy to clean

**100%**  
Platinum  
silicone

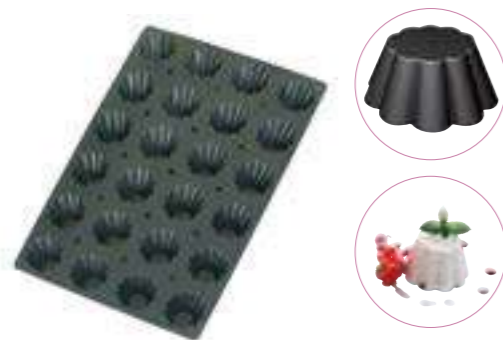

### Brioche 24 cavidades

Brioche 24 cavités · Briocheform für 24 Madaleine  
Brioche 24 moulds · Brioche 24 cavidades

Ref	€	Ø (mm)	h (mm)	ml
66760	100,20	79	35	84



### Semiesférica 28 cavidades

Hemispher 28 cavités · Halbkugelform für 28 Madaleine  
Half-spheres 28 moulds · Semi-esférica 28 cavidades

Ref	€	Ø (mm)	h (mm)	ml
66761	100,20	70	35	90

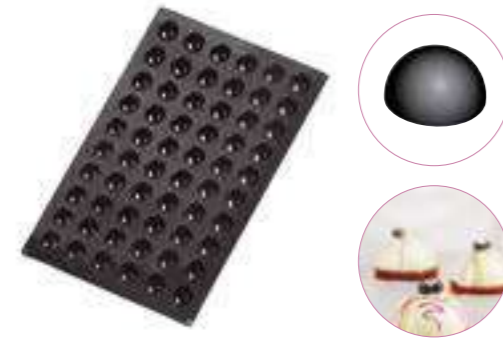

### Semiesférica 60 cavidades

Hemispher 60 cavités · Halbkugelform für 60 Madaleine  
Half-spheres 60 moulds · Semi-esférica 60 cavidades

Ref	€	Ø (mm)	h (mm)	ml
66747	98,30	42	20	10

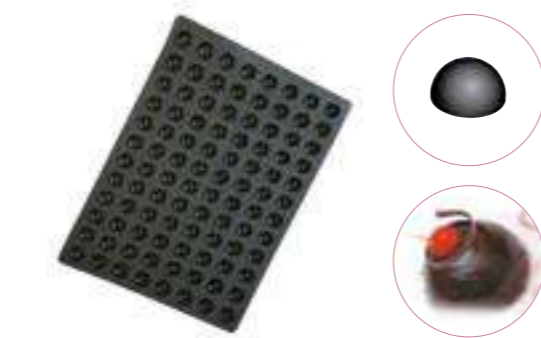

### Mini semiesférica 96 cavidades

Mini Hemispher 96 cavités · Mini Halbkugelform für 96 Madaleine  
Mini Half-spheres 96 moulds · Mini semi-esférica 96 cavidades

Ref	€	Ø (mm)	h (mm)	ml
66762	100,20	35	17,5	11



### Florentina 15 cavidades

Florentine 15 cavités · Florentinerform für 15 Madaleine  
Florentina 15 moulds · Florentina 15 cavidades

Ref	€	Ø (mm)	h (mm)	ml
66748	98,30	100	20	100



### Madalena 44 cavidades

Madeleine 44 cavités · Madeleinform für 44 Madaleine  
Madeleine 44 moulds · Madalena 44 cavidades

Ref	€	mm	h (mm)	ml
66763	100,20	77x44,5	18	32



### Muffin 24 cavidades

Muffin 24 cavités · Muffinform für 24 Madaleine  
Muffin 24 moulds · Muffin 24 cavidades

Ref	€	Ø (mm)	h (mm)	ml
66766	100,20	69	39	122



### Piramide 35 cavidades

Pyramide 35 cavités · Pyramidenform für 35 Madaleine  
Pyramid 35 moulds · Pirámide 35 cavidades

Ref	€	mm	h (mm)	ml
66768	100,20	65x65	35	61



### Florentina 40 cavidades

Florentine 40 cavités · Florentinerform für 40 Madaleine  
Florentina 40 moulds · Florentina 40 cavidades

Ref	€	Ø (mm)	h (mm)	ml
66764	100,20	60	11	25



### Mini muffin 70 cavidades

Mini muffin 70 cavités · Mini Muffinform klein für 70 Madaleine  
Mini muffin 70 moulds · Mini muffin 70 cavidades

Ref	€	Ø (mm)	h (mm)	ml
66765	100,20	45	30	40



### Tartaleta 60 cavidades

Tartalette 60 cavités · Torteleitform für 60 Madaleine  
Tartlet 60 moulds · Tarte 60 cavidades

Ref	€	Ø (mm)	h (mm)	ml
66767	100,20	44	10	10



### Mini cake 30 cavidades

Mini cake 30 cavités · Mini Kuchenform für 30 Madaleine  
Mini cake 30 moulds · Mini cake 30 cavidades

Ref	€	mm	h (mm)	ml
66769	100,20	99x49	30	110

# PASTRYFLEX

## Colección moldes



ES

- Amplia gama de moldes de silicona para procesos de horneado y congelación.
- Antiadherentes, flexibles, duraderos, higiénicos y fáciles de limpiar.
- Soportan fuertes cambios de temperatura.
- No transmiten sabores ni olores.
- Permiten desmoldar fácil y perfectamente los alimentos.

FR

- Large gamme de moules en silicone pour enfourner et congeler.
- Antiadhésifs, flexibles, durables, hygiéniques et faciles à nettoyer.
- Supportent de fortes variations de température.
- Ne transmettent ni goûts ni odeurs.
- Permettent de démouler facilement et parfaitement les aliments.

EN

- Wide range of silicone moulds for baking and freezing processes.
- Non-stick, flexible, long-lasting, hygienic and easy to clean.
- They can withstand drastic temperature changes.
- They do not transmit flavours or odours.
- Food can be de-moulded quickly and perfectly with them.

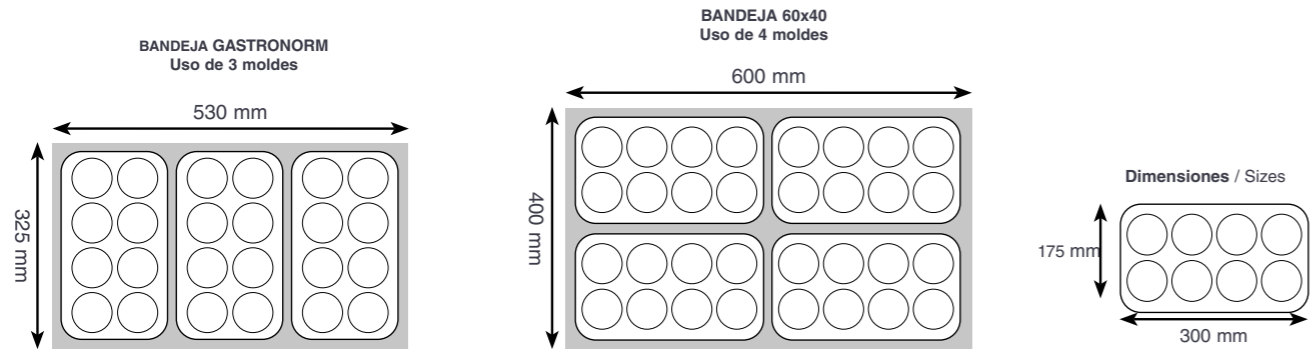

### Cilindro 8 cavidades

Cylindre 8 cavités · Zylinderform für 8 Madeleine  
Cilindro 8 moulds · Cilindro 8 cavidades

Ref	€	Ø (mm)	h (mm)	ml	U.Venta
66807	15,60	60	35	90	1

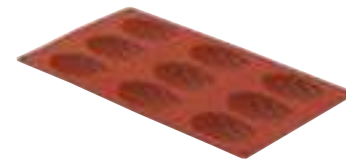

### Madalena 9 cavidades

Madeleine 9 cavités · Madeleineform 9 Madeleine  
Madeleine 9 moulds · Madalena 9 cavidades

Ref	€	mm	h (mm)	ml	U.Venta
66817	15,60	78x45	17	30	1



### Briochette 6 cavidades

Briochette 6 cavités · Briocheform 6 Madeleine  
Briochette 6 moulds · Briochette 6 cavidades

Ref	€	Ø (mm)	h (mm)	ml	U.Venta
66820	15,60	79	30	110	1



### Madalena pequeña 15 cavidades

Petite madeleine 15 cavités · Madeleineform, Klein, für 15 Madeleine  
Small madeleine 15 moulds · Madalena pequena 15 cavidades

Ref	€	mm	h (mm)	ml	U.Venta
66816	15,60	42x30	11,5	10	1



### Briochette 6 cavidades

Briochette 6 cavités · Briocheform 6 Madeleine  
Briochette 6 moulds · Briochette 6 cavidades

Ref	€	Ø (mm)	h (mm)	ml	U.Venta
66819	15,60	103	20	110	1

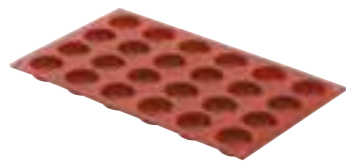

### Semiesférica 24 cavidades

Hemispher 24 cavités · Halbkugelform 24 Madeleine  
Half-spheres 24 moulds · Semi-esférica 24 cavidades

Ref	€	Ø (mm)	h (mm)	ml	U.Venta
66800	15,60	30	17	10	1

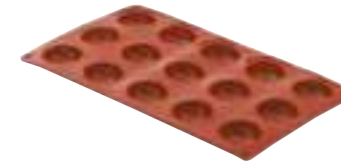

### Semiesférica 15 cavidades

Hemispher 15 cavités · Halbkugelform 15 Madeleine  
Half-spheres 15 moulds · Semi-esférica 15 cavidades

Ref	€	Ø (mm)	h (mm)	ml	U.Venta
66801	15,60	40	20	20	1



### Pirámide 6 cavidades

Pyramide 6 cavités · Pyramideform 6 Madeleine  
Pyramid 6 moulds · Pirâmide 6 cavidades

Ref	€	mm	h (mm)	ml	U.Venta
66822	15,60	71x71	41	90	1



### Mini muffin 11 cavidades

Mini muffin 11 cavités · Muffinform klein für 11 Madeleine  
Mini muffin 11 moulds · Mini muffin 11 cavidades

Ref	€	Ø (mm)	h (mm)	ml	U.Venta
66804	15,60	50	28	50	1

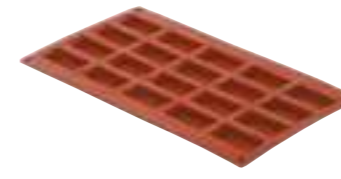

### Rectángulo pequeño 20 cavidades

Petit rectangle 20 cavités · Form rechteckig für 20 Madeleine  
Petit-four 20 moulds · Rectangulo pequeno 20 cavidades

Ref	€	mm	h (mm)	ml	U.Venta
66825	15,60	49x26	11	20	1



### Mini savarín 18 cavidades

Mini savarin 18 cavités · Savarinform 18 Madeleine  
Mini savarin 18 moulds · Mini savarin 18 cavidades

Ref	€	Ø (mm)	h (mm)	ml	U.Venta
66808	15,60	41	12	18	1



### Semiesférica 6 cavidades

Hemispher 6 cavités · Halbkugelform 6 Madeleine  
Half-spheres 6 moulds · Semi-esférica 6 cavidades

Ref	€	Ø (mm)	h (mm)	ml	U.Venta
66802	15,60	70	35	80	1



### Muffin 6 cavidades

Muffin 6 cavités · Muffinform 6 Madeleine  
Muffin 6 moulds · Muffin 6 cavidades

Ref	€	Ø (mm)	h (mm)	ml	U.Venta
66805	15,60	70	40	100	1



### Corazón 8 cavidades

Coeur 8 cavités · Herzform 8 Madeleine  
Heart 8 moulds · Coração 8 cavidades

Ref	€	mm	h (mm)	ml	U.Venta
66824	15,60	65x60	35	90	1



### Cake 12 cavidades

Cake 12 cavités · Kuchenform 12 Madeleine  
Cake 12 moulds · Cake 12 cavidades

Ref	€	mm	h (mm)	ml	U.Venta
66826	15,60	80x30	30	70	1





### Molde de flan 6 cavidades

Moule à flan 6 cabités · Madeleine Backform für 6 Madeleine  
Creme caramel 6 moulds · Molde de flan 6 cavidades

Ref	€	cm	h (cm)	L	U.Venta
66736	21,80	29x19	5	0,16	1



Con anilla de refuerzo  
With a reinforced ring

### Molde cake

Moule à cake · Kuchenform  
Cake mould · Molde cake

Ref	€	cm	h (cm)	L	U.Venta
66733	21,60	24x10	6,5	1,50	1
66742	23,70	26x10	7,0	1,55	1



Con anilla de refuerzo  
With a reinforced ring

### Molde savarín bajo

Moule Savarin bas · Savarinform, klein  
Low Savarin mould · Molde pudín baixo

Ref	€	Ø (cm)	h (mm)	L	U.Venta
66734	21,80	24	6,0	1,25	1



Con anilla de refuerzo  
With a reinforced ring

### Molde savarín alto

Moule Savarin haut · Savarinform, gross  
High Savarin mould · Molde pudín alto

Ref	€	Ø (cm)	h (mm)	L	U.Venta
66735	23,80	22	11,0	2,20	1



Con anilla de refuerzo  
With a reinforced ring

### Molde redondo

Moule à manque · Tortenform  
Round cake mould · Molde redondo

Ref	€	Ø (cm)	h (mm)	L	U.Venta
66737	21,20	24	4,5	1,70	1
66738	21,80	26	4,5	2,20	1



# DESMONTABLES

## Colección moldes



### ES

- Molde 100% silicona alimentaria antiadherente a prueba de goteo.
- Base de cristal con recubrimiento antiadherente; perfecto para presentarlo en la mesa sobre la misma base.
- Se desmolda fácilmente.
- Sistema de cierre seguro antiderrame; ideal para pasteles y tartas delicadas.
- Apto para el horno.
- Fácil limpieza. Se puede lavar en el lavavajillas.

### FR

- Moule 100% silicone alimentaire antiadhésif anti-gouttes.
- Base en verre avec revêtement antiadhésif ; parfaite pour présenter les mets sur la table.
- Démoulage facile.
- Système de fermeture sûr anti-coulures ; idéal pour les gâteaux et tartes délicates.
- Apte pour le four.
- Nettoyage facile. Peut se laver au lave-vaisselle.

### EN

- Non-stick leak proof mould made of 100% food grade silicone.
- Cut resistant glass base coating; perfect for serving at the table on the same base.
- Easily removed from the mould.
- Secure spill-proof locking system; ideal for delicate cakes and tarts.
- Oven safe.
- Easy to clean. Dishwasher safe.

Base de cristal antiadherente  
Glass base non stick



### Molde desmontable

Moule demontable · Backform, zerlegbar  
Dismountable mould · Molde desmontável

	Ref	€	Ø (cm)	h (cm)	L	U.Venta	
	66775	22,50	25	7,5	2,0	1	Acabado brillo · Gloss finish
A	66778	17,50	20	7,5	1,6	1	Acabado mate · Matt finish
B	66776	21,80	29x13	7,0	1,5	1	Acabado brillo · Gloss finish
	66777	25,40	25x25	7,5	2,5	1	Acabado brillo · Gloss finish
C	66779	21,00	18x18	7,0	2,3	1	Acabado mate · Matt finish

\* Apto para la freidora de aire (69511) · Suitable for air fryer (69511)

# PLATINIUM

## Colección moldes

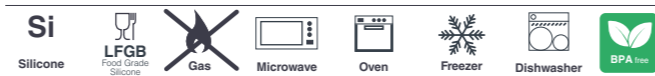

### ES

- Fabricados 100% en silicona platino de máxima calidad. Libres de BPA.
- Ligeros, flexibles y antiadherentes; muy fáciles de desmoldar.
- Apilables.
- Aptos para horno, microondas y congelador.
- Se limpian muy fácil y son aptos para el lavavajillas.

### FR

- Fabriqués en 100% silicone platine de la plus haute qualité. Sans BPA.
- Légers, flexible et antiadhésifs ; très faciles à démouler.
- Empilables.
- Peuvent aller au four, au micro-ondes et au congélateur.
- Facile à nettoyer et lavable au lave-vaisselle.

### EN

- Made of 100% top quality platinum-cured silicone.
- Lightweight, flexible and non-stick. Very easy to de-mould.
- Stapelbar.
- Oven, microwave and freezer safe.
- It's very easy to clean and dishwasher safe.



### Set de 2 moldes donuts

Ensemble de 2 moules à donuts - Set mit 2 Donut-Formen  
Set of 2 doughnut moulds - Conjunto de 2 moldes para donuts

Ref	€	Ø (cm)	h (mm)	L	U.Venta
68770	16,90	7,0	2	0,07	1



### Molde donuts

Moules à donuts · Donut-Formen Zweier  
Doughnut moulds · Molde para donuts

Ref	€	Ø (cm)	h (mm)	L	U.Venta
68760	8,50	7,0	2	0,07	1



### Molde donuts rizado

Moules à donuts frisé · Donut-Formen  
Doughnut moulds curly · Molde para donuts frizado

Ref	€	Ø (cm)	h (mm)	L	U.Venta
68761	10,80	6,5	2	0,08	1



### Molde muffin

Moules à muffin · Muffinform  
Muffin mould · Molde muffin

Ref	€	Ø (cm)	h (mm)	L	U.Venta
68763	11,30	6,5	3	0,08	1



### Molde cake

Moules à cake · Kuchenform  
Cake mould · Molde cake

Ref	€	cm	h (mm)	L	U.Venta
68764	10,10	23,5x10	6	1,15	1



### Molde redondo rizado

Moules à manque frisé · Tortenform  
Curly round mould · Molde redondo frizado

Ref	€	Ø (cm)	h (mm)	L	U.Venta
68766	12,80	30	4,5	1,20	1



### Molde savarín bajo

Moules à savarin basse · Savarinform  
Low savarinmould · Molde savarin baixo

Ref	€	Ø (cm)	h (mm)	L	U.Venta
68768	16,20	25	7,0	1,50	1



### Molde flan rizado

Moules à fran · Becherförmchen  
Pudding mould · Molde para flan

Ref	€	Ø (cm)	h (mm)	L	U.Venta
68762	11,30	7,0	4	0,10	1



### Molde redondo

Moules à manque · Tortenform  
Round mould · Molde redondo

Ref	€	Ø (cm)	h (mm)	L	U.Venta
68765	13,00	28	3	1,80	1



### Molde savarín

Moules à savarin · Savarinform  
Savarin mould · Molde savarin

Ref	€	Ø (cm)	h (mm)	L	U.Venta
68767	19,80	22	11	2,30	1

Apto para las freidoras de aire (69509/69511)  
Suitable for air fryers (69509/69511)



### Molde savarín mini

Moules mini savarin · Savarinform Mini  
Mini savarinmould · Molde mini savarin

Ref	€	Ø (cm)	h (mm)	L	U.Venta
68769	8,60	15	6,5	0,50	1

# REPOSTERÍA

Moldes · Tapetes · Láminas



Apto para todas las freidoras de aire  
Suitable for all air fryers



30 macarons -> 5cm  
48 macarons -> 4cm

Flexible, antiadherente y reutilizable  
Flexible, non-stick and reusable



### Molde macarons doble

Moule macarons double · Doppel Macaronsform  
Macarons dual mould · Molde macarons duplo

Ref	€	cm	U.Venta
66753	12,60	39x29	1



### Set 12 moldes muffin silicona

Set 12 moules muffin en silicone · Set 12 Muffin formen, Silikon  
Silicone 12 muffin moulds set · Conjunto 12 moldes muffin en silicone

Ref	€	Ø (cm)	h (cm)	U.Venta
66745	5,60	7	5	1

Incluye · Includes:  
1.- Tablas de conversión de temperatura (°C / °F)  
2.- Peso (gr / oz)  
3.- Volumén ml / flaz / pt)  
4.- Longitud (mm / inch)  
5.- Reglas laterales (cm / inch)

Flexible, antiadherente y reutilizable  
Flexible, non-stick and reusable



### Tapete de silicona impreso

Tapis en silicone imprime · Bedruckte Silikonmatte  
Printed silicon mat · Tapete de silicone impreso

Ref	€	cm	U.Venta
66759	28,90	60x40	1



### Tapete de silicona

Tapis en silicone · Backblech-Auflage Silikon  
Silicone covering · Tapete de silicone

Ref	€	cm	U.Venta
66749	20,30	30x40	1
66731	28,10	60x40	1
66732	20,80	52x32 GN 1/1	1

Apto para todas las freidoras de aire · Suitable for all air fryers

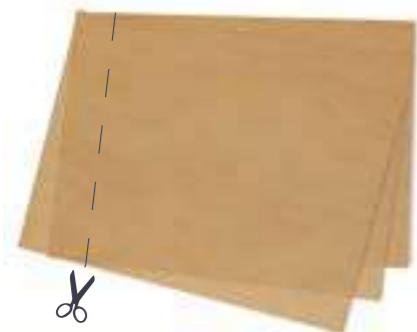

3 pcs

Fácil de cortar  
Easy to cut

### Láminas antiadherentes

Feuilles antiadhésif · Antihalt-Blätter  
Non-stick sheets · Láminas antiaderentes

Ref	€	cm	unidades	U.Venta
66746	9,80	30x40	3	1



- Láminas de fibra de vidrio con recubrimiento antiadherente de gran calidad.
- Ideal para colocar sobre bandejas o parrillas de hornos y deshidratadores.
- Vida útil aproximadamente de 1000 horneados.
- Diseñadas para soportar temperaturas de hasta 250°C.
- Recortable para adaptar a cualquier recipiente.
- Reutilizables, para una correcta conservación se recomienda su lavado a mano.
- No aptas para el lavavajillas.

- Fibreglass sheets with non-stick coating high-quality.
- Ideal for placing on baking trays, oven racks and dehydrators.
- Can be used approximately 1,000 times.
- Designed to withstand temperatures up to 250°C.
- Can be cut to fit any container.
- Reusable; in order to keep the sheets in good condition, we recommend washing by hand.
- Non-dishwasher safe.

# HORNO

Parrillas · Placas · Pinzas



Inox

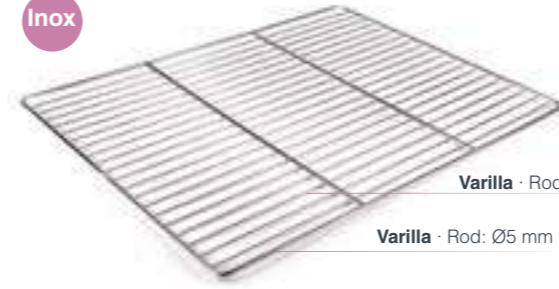

Varilla · Rod: Ø22 mm

Varilla · Rod: Ø5 mm

### Parrilla

Grille · Gitter, Rost  
Grate · Grelha

Ref	€	cm	h (cm)	U.Venta
68741	29,80	60x40	0,8	1

Inox

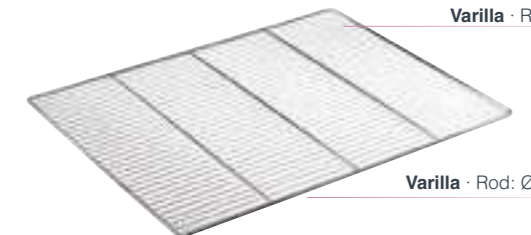

Varilla · Rod: Ø3 mm

Varilla · Rod: Ø6 mm

### Parrilla

Grille · Gitter, Rost  
Grate · Grelha

Ref	€	cm	Cubeta	U.Venta
66920	53,60	65X53	2/1	1
66921	20,60	53X32,5	1/1	1

AL  
Aluminium



### Placa horno aluminio antiadherente

Plaque à four aluminium anti-adhésif teflon · Backblech, Aluminium, Teflon  
Teflon non-stick coated oven aluminium tray · Placa forno alumínio anti-aderente

Ref	€	cm	h (cm)	U.Venta
68660	37,20	60x40	1,0	1
68659	33,80	GN 1/1	1,0	1

Fe  
Hierro/iron



### Placa horno acero negro

Plaque à four toile noire · Backblech, Schwarzstahl  
Baking sheet black steel · Placa de forno aço negro

Ref	€	cm	h (cm)	U.Venta
68640	36,60	60x40	0,8	1

Inox



### Placa horno

Plaque à four · Backblech  
Baking sheet · Placa de forno

Ref	€	cm	h (cm)	U.Venta
68740	44,20	60x40	0,8	1
68739	34,20	GN 1/1	0,8	1

AL  
Aluminium



### Placa horno

Plaque à four · Backblech  
Baking sheet · Placa de forno

Ref	€	cm	h (cm)	U.Venta
68641	34,70	60x40	0,8	1
68642	28,00	GN 1/1	0,8	1



### Pinza para horno y bandeja GN

Pince inox pour bac Gastronorm · Zange für GN Behälter  
Tong GN tray · Pinça para forno e bandejas GN

Ref	€	L (cm)	U.Venta
A 62989	17,00	20	12
B 62998	17,00	20	12

Con silicona · With silicone



# INOX 18/10

## Moldes



### Cadena repostería

Chaire pour pâtisserie · Kette für Konditorei  
String for pastry · Corrente para pastelería

Ref	€	L (m)	U.Venta
68248	12,00	1,80	12



### Molde 1/2 caña desmontable redondo

Gouttière à bûche · Terrinen-/Kuchenform "Dachrinne",  
Round cake mould · Molde 1/2 cana desmontável redondo

Ref	€	cm	h (cm)	U.Venta
68001	39,20	25x9	6,0	1
68002	49,10	50x9	6,0	1



### Marco rectangular

Rectangle · Rahmen, rechteckig,  
Rectangular frame · Molde rectangular

Ref	€	cm	h (cm)	U.Venta
68043	30,20	30x40	3,0	1
68048	30,40	31x48	3,0	1
68060	33,20	40x60	3,0	1
68041	30,40	30x40	5,0	1
68049	31,70	31x48	5,0	1
68061	34,40	40x60	5,0	1



### Flanero

Moule à flan · Pudding-/Becherförmchen  
Pudding mould · Forma flan

Ref	€	Ø (cm)	h (cm)	ml	U.Venta
60007	4,30	7	5,0	100	10
60008	5,20	8	5,3	200	10



### Molde 1/2 caña desmontable triangular

Moule triangle "demie canne" · Terrinen-/Kuchenform "Dachrinne",  
Three-cornered cake mould · Molde 1/2 cana desmontável triangular

Ref	€	cm	h (cm)	U.Venta
68003	38,20	25,5x9,4	9,4	1
68004	47,80	50,7x9,4	9,4	1



### Bandeja

Plaque · Backblech  
Baking sheet · Bandeja

Ref	€	cm	h (cm)	U.Venta
68030	39,00	30x40	1,0	1
68031	39,40	31x48	1,0	1
68040	69,60	40x60	1,0	1

# ALUMINIO

## Moldes



### ES

- Amplia gama de moldes de aluminio con antiadherente para horno.
- Resistente a altas temperaturas, excelente conductor de calor.
- Recubrimiento antiadherente por toda la superficie de la pieza.



### Set 4 flaneros

Jeu 4 Moule à flan · 4 Pudding-/Becherförmchen  
4 pcs. pudding mould · Conjunto 4 formas flan

Ref	€	Ø (cm)	h (cm)	U.Venta
68808	14,40	8	5,2	6



### Molde rizado

Moule à tarte fond fixe · Tortenbodenform, gewellter Rand.  
Tart mould · Molde frizado

Ref	€	Ø (cm)	h (cm)	U.Venta
68723	10,90	24	3,7	6
68729	12,30	28	3,7	6
68732	13,00	32	3,7	6



### Molde savarín

Moule à Savarin · Reistrand/Savarinform  
Savarin mould · Molde pudim

Ref	€	Ø (cm)	h (cm)	U.Venta
68724	17,10	24x6,5	5,7	6
68862	18,50	26x6,5	6,0	6
68863	18,80	28x6,5	6,0	6

### FR

- Large gamme de moules pour four en aluminium avec antiadhésif.
- Résistant à de hautes températures, excellent conducteur de chaleur.
- Revêtement antiadhésif sur toute la surface de la pièce.



### Molde cake

Moule à cake · Kuchenform, konisch  
Cake mould · Molde cake

Ref	€	L (cm)	h (cm)	U.Venta
68825	12,20	25	7	6
68831	14,30	30	7	6
68835	15,40	35	7	6



### Molde rizado móvil

Moule à tarte fond mobile · Kuchenform, konisch  
Fruit tart mould · Molde frizado-fundo móvil

Ref	€	Ø (cm)	h (cm)	U.Venta
68842	12,50	24	3	6
68882	16,50	28	3	6
68823	20,40	32	3	6



### Molde pizza

Moule à pizza · Pizzablech  
Pizza mould · Molde pizza

Ref	€	Ø (cm)	h (cm)	U.Venta
68824	9,90	24	1,8	6
68828	10,60	28	1,8	6
68832	13,20	32	2,0	6
68836	14,90	36	2,0	6

### EN

- Wide range of non-stick aluminium moulds for the oven.
- Resistant to high temperatures, excellent heat conductor.
- The entire surface of the mould has a non-stick coating.



### Molde alto

Moule à manque · Käsekuchenform  
Pie mould · Molde alto

Ref	€	Ø (cm)	h (cm)	U.Venta
68822	10,20	22	4,7	6
68827	11,10	26	5,0	6
68829	12,80	30	5,0	6
68833	14,00	32	5,2	6



### Molde rizado

Moule à brioche · Briocheform  
Brioche mould · Molde flan frizado

Ref	€	Ø (cm)	h (cm)	U.Venta
68810	5,60	10	4,0	6
68814	7,50	14	5,5	6
68818	8,40	18	6,5	6
68821	11,40	22	10	6



### Molde pizza perforado

Moule à pizza perforé · Pizzablech, gelocht  
Perforated Pizza mould · Molde pizza perforado

Ref	€	Ø (cm)	h (cm)	U.Venta
67824	11,40	24	1,8	6
67828	12,10	28	1,8	6
67832	12,90	32	2,0	6
67836	13,60	36	2,0	6

# DELIZE

## Colección moldes



New

### ES

- Fabricados en acero al carbono.
- Antiadherente interior y exterior de máxima calidad, ecológico y libre de PFOA.
- Diseñados para elaborar recetas con masas densas, ideal para tartas, pasteles, bizcochos, etc.
- La base desmontable y el clip lateral garantizan un mejor desmoldado y una mayor facilidad de uso.
- Resistentes a altas temperaturas.
- Fondo rugoso para una distribución uniforme y retención del calor.
- Aptos para el horno, nevera y congelador.

### FR

- Fabriqués en acier carbone.
- Antiadhésif intérieur et extérieur de la plus grande qualité, écologique et sans PFOA.
- Conçus pour des recettes avec des pâtes denses, idéal pour des tartes, gâteaux, génoises, etc.
- La base démontable et la charnière latérale garantissent un meilleur démoulage et une plus grande facilité d'utilisation.
- Résistants aux hautes températures.
- Fond rugueux pour une rétenion et une distribution uniforme de la chaleur.
- Aptes pour le four, le réfrigérateur et le congélateur.

### EN

- Made of carbon steel.
- Top quality non-stick inner and outer coating, environmentally friendly and PFOA-free.
- Designed for making heavy dough recipes and ideal for tarts, pies, sponge cakes, etc.
- Its spring form base and side clasp make releasing the mould quick and easy to use.
- High temperature resistant.
- Rough bottom for evenly distributing and retaining heat.
- Oven, fridge and freezer safe.

Fondo rugoso para una distribución uniforme y retención del calor  
Rough bottom for evenly distributing and retaining heat



### Molde desmontable

Moule démontable · Kuchenform  
Dismountable mould · Molde desmontável

Ref	€	Ø (cm)	h (cm)	L	U.Venta
68676	7,70	18	6,8	1,50	1
68680	8,10	20	6,8	1,90	1
68684	9,30	24	6,8	2,80	1
68686	9,90	26	6,8	3,30	1
68688	10,90	28	6,8	3,80	1
68696	11,70	16	13	2,00	1

### Molde baguette

Moule à baguette · Baguette-Form  
Baguette mould · Molde para baguettes

Ref	€	cm	h (cm)	Cav.	U.Venta
68450	11,10	38x33	2,6	4	1



### Molde cake

Moule à cake · Kuchenform, konisch  
Cake mould · Molde cake

Ref	€	cm	h (cm)	L	U.Venta
68451	6,10	25x11,5	7,0	1,60	1
68452	7,10	31x11,5	7,0	1,90	1
68453	8,60	35,6x11,5	7,0	2,25	1



### Molde alto

Moule à manque · Käsekuchenform  
Pie mould · Molde alto

Ref	€	Ø (cm)	h (cm)	L	U.Venta
68455	5,90	24	4,5	1,50	1
68456	7,70	28	4,5	2,00	1

A



B



### Molde rizado alto

Moule à tarte fond fixe · Tortenbodenform, gewellter Rand.  
Tart mould · Molde frizado

Ref	€	Ø (cm)	h (cm)	L	U.Venta
68797	9,40	20	5,0	1,25	1
68798	10,00	24	5,0	1,90	1
68799	12,50	28	5,0	2,80	1
68787	9,80	20	5,0	-	1
68788	10,70	24	5,0	-	1
68789	12,80	28	5,0	-	1



### COMPOSICIÓN:

- Bandeja: 38,2x26x1,5 cm
- Molde muffin: 33,5x20,5x3 cm (0,98 L)
- Molde cuadrado: 24x22x5,5 cm (2,01 L)
- Molde cake: 24x12x5,5 cm (0,90 L)
- Rustidera: 38,2x26x5 cm (3,40 L)



### Set 5 moldes

Ensemble de 5 moules · Satz mit 5 Förmchen  
Set of 5 moulds · Conjunto de 5 moldes

Ref	€	Piezas	U.Venta
68461	38,90	5	1



### Molde savarín

Moule à Savarin · Reistrand/Savarinform  
Savarin mould · Molde pudim

Ref	€	Ø (cm)	h (cm)	L	U.Venta
68454	10,90	26	8,6	2,15	1

A



B



### Molde rizado

Moule à tarte fond fixe · Tortenbodenform, gewellter Rand.  
Tart mould · Molde frizado

Ref	€	Ø (cm)	h (cm)	L	U.Venta
68790	4,40	14	2,5	0,30	1
68791	6,40	20	2,5	0,60	1
68792	8,30	24	2,8	1,00	1
68793	8,90	26	2,8	1,20	1
68794	9,40	28	3,0	1,45	1
68795	10,40	30	3,0	1,50	1
68796	11,20	32	3,0	1,70	1
68780	4,70	14	2,5	-	1
68781	6,70	20	2,5	-	1
68782	8,60	24	3,0	-	1
68783	9,30	26	3,0	-	1
68784	10,20	28	3,0	-	1
68785	10,90	30	3,0	-	1
68786	11,80	32	3,0	-	1

A



B



### Molde pizza

Moule à pizza · Pizzablech  
Pizza mould · Molde pizza

Ref	€	Ø (cm)	h (cm)	U.Venta
68472	5,30	29,5	1,5	1
68473	6,10	34,0	2,0	1
68470	6,50	33,5	1,0	1
68471	8,40	36,0	1,0	1

A

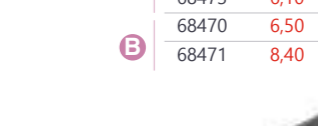

B



### Bandeja

Plateaux · Tablett  
Tray · Bandeja

Ref	€	cm	h (cm)	U.Venta
68462	12,80	34x24	2,5	1
68463	13,90	39x26,5	3,0	1
68464	16,00	44x29	3,0	1

# NOIR

## Moldes



### ES

- Ideal para preparar todo tipo de postres, pudding, gelatinas o mousses, fríos o calientes.
- Fabricados en acero al carbono.
- Revestimiento antiadherente de gran calidad sin PFOA en el interior y el exterior.
- Distribuyen el calor de manera uniforme.
- Apto para hornos hasta 240°C.
- No se recomiendan lavarlos en el lavavajillas.

### FR

- Idéal pour préparer tout type de desserts, puddings, gélatines ou mousses, froids ou chauds.
- Fabriqués en acier au carbone.
- Revêtement antiadhésif de grande qualité sans PFOA à l'intérieur et à l'extérieur.
- Distribue uniformément la chaleur.
- Compatible avec les fours jusqu'à 240°C.
- Il est déconseillé de le laver au lave-vaisselle.

### EN

- Ideal for making all types of hot or cold desserts, puddings, jellies or mousses.
- Made of carbon steel.
- High quality PFOA-free non-stick coating on the inside and outside.
- Distributes heat evenly.
- Suitable for ovens up to 240°C.
- Dishwasher use is not recommended.



### Molde 12 cavidades madalenas

Plaque madeleine 12 alveoles · Muffinform 12 Madeleine  
12 cups madelaine pan · Molde cavidades 12 madalenas

Ref	€	cm	h (cm)	U.Venta
68000	15,30	39,8x19,5	2,0	1



### Molde 12 cavidades

Plaque à biscuits 12 alveoles · Madeleine-Backform für 12 Madeleine  
12 cups muffin pan · Molde 12 cavidades

Ref	€	cm	h (cm)	U.Venta
68010	18,10	35x26,5	3,0	1



### Molde cake chapa antiadherente

Moule à cake tôle anti-adh. · Back/Pastetenform, Antihaft  
Cake mould rolled. · Molde cake chapa aderente

Ref	€	cm	h (cm)	U.Venta
68725	8,80	25x12	8,5	6
68730	9,00	30x12	8,5	6
68735	9,90	35x12	8,5	6



### Molde desmontable redondo

Moule rond desmontable · Tortenbodenform  
Dismountable round mould · M. desmontável redondo

Ref	€	Ø (cm)	h (cm)	U.Venta
68714	10,80	24	7	1
68716	11,30	26	7	1
68718	11,40	28	7	1

# BOMBÓN

## Moldes



### ES

- Molde profesional para elaborar deliciosos y originales bombones.
- Fabricado en poliestireno de alta calidad.
- Se obtienen bombones perfectos y con un brillo único.
- Cómodo de utilizar: rellena el molde con chocolate fundido, retira el exceso de chocolate, deja reposar, vuelca el molde y da un pequeño golpe para que salgan los bombones.
- Fácil de limpiar y resistentes al uso diario.
- Superficie lisa para un mejor desplazamiento de la espátula a la hora de retirar el chocolate sobrante.

### FR

- Moule professionnel pour élaborer de délicieux et originaux chocolats.
- Fabriqué en polystyrène de grande qualité.
- Permet d'obtenir des chocolats parfaits avec une brillance unique.
- Facile à utiliser : Remplir le moule de chocolat fondu, retirer l'excès de chocolat, laisser reposer, retourner le moule et tapoter légèrement pour faire sortir les chocolats.
- Facile à nettoyer et résistant à l'usage quotidien.
- Surface lisse pour un meilleur mouvement de la spatule lors du retrait du chocolat excédentaire.

### EN

- Professional mould for making delicious and original chocolates.
- Made of high quality polystyrene.
- Makes perfect chocolates with a unique shine.
- Easy to use: Fill the mould with melted chocolate. Remove the excess chocolate. Let sit. Flip the mould over and tap gently to get the chocolates out.
- Easy to clean and stands up to daily use.
- Smooth finish so a spatula will slide easily over the surface when removing extra chocolate.

### Dimensiones / Sizes

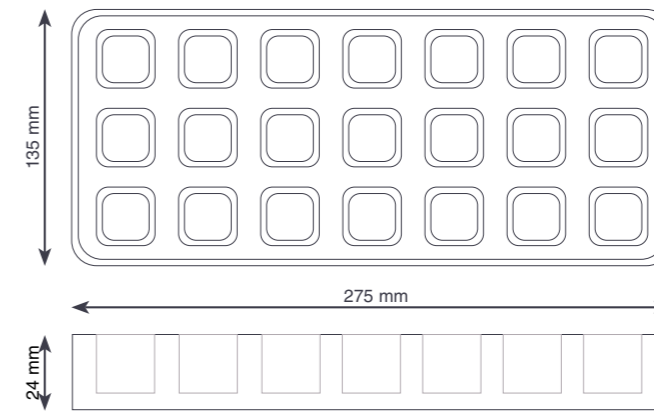

### Molde bombón

Moule pour chocolats · Pralinengießform  
Chocolate mould · Molde para bombons

	Ref	€	mm	h (mm)	ml	U.Venta	
A	66870	17,40	Ø28	19,0	7	1	Semiesférica · Half-sphere
B	66871	17,40	25x20	11,5	6	1	Corazón · Heart
C	66872	17,40	25,5x24,5	17,0	10	1	Lineal · Linear
D	66874	17,40	25x25	17,0	10	1	Cuadrado · Square
E	66875	17,40	32x19	12,0	7	1	Hoja · Leaf
F	66877	17,40	32x25	12,5	7	1	Ondulado · Ondulated

# AROS REPOSTERÍA

## Colección



### ES

- Fabricados en acero inoxidable 18/10.
  - Ideal para brisa, hojaldre y choux.
  - Consigue bordes regulares, bien denidos y con una extracción perfecta de la base. Acabado excepcional.
  - Disponible en distintas formas y tamaños.
  - Aros perforados: innovadores aros de acero inoxidable microperforados.
- Las microperforaciones permiten la circulación de aire durante la cocción, consiguiendo una cocción más rápida y homogénea.

### FR

- Fabriquée en acier inoxydable 18/10.
- Idéal pour la pâte brisée, la pâte feuilletée et la pâte à choux.
- Obtenez des bords réguliers, bien dénis, et avec une extraction parfaite de la base.
- Finition exceptionnelle.
- Disponible en plusieurs formes et tailles.
- Cercles perforés : cercle en acier inoxydable micro-perforé innovant. Les micro-perforations permettent la circulation d'air pendant la cuisson, obtenant ainsi une cuisson plus rapide et homogène.

### EN

- Manufactured in stainless steel 18/10.
- Ideal for shortcrust, puff and choux pastry.
- Get even, well-dened edges and a perfect extraction of the base. Exceptional nish.
- Available in various different shapes and sizes.
- Perforated ring: innovative microperforated stainless steel tart ring. The microperforations enable air to circulate during cooking, ensuring faster and more even cooking.



#### Aro redondo

Cercle rond · Kuchen-/Ausstechformen, rund  
Round cake ring · Aro redondo

Ref	€	Ø (cm)	h (cm)	U.Venta
68406	3,00	6	4	12
68407	3,10	7,5	4	12
68408	3,20	8	4	12
68410	3,30	10	4	12
68412	5,20	12	4	12
68414	4,90	14	4	6
68416	6,70	16	4	6
68418	8,00	18	4	6
68420	9,70	20	4	1
68422	9,80	22	4	1
68424	11,10	24	4	1



#### Aro redondo ENTREMET

Cercle rond · Kuchen-/Ausstechformen, rund  
Round cake ring · Aro redondo

Ref	€	Ø (cm)	h (cm)	U.Venta
68308	3,10	8	3,5	12
68310	3,10	10	3,5	12



#### Aro redondo MOUSE

Cercle rond · Kuchen-/Ausstechformen, rund  
Round cake ring · Aro redondo

Ref	€	Ø (cm)	h (cm)	U.Venta
68506	3,00	6	4,5	12
68508	3,10	8	4,5	12
68509	3,20	9	4,5	12
68510	3,30	10	4,5	12
68512	4,20	12	4,5	12
68514	4,90	14	4,5	12
68516	6,80	16	4,5	6
68518	7,90	18	4,5	6
68520	8,60	20	4,5	6
68522	10,00	22	4,5	1
68524	10,40	24	4,5	1
68526	11,50	26	4,5	1

#### Molde cuadrado

Carre pour patisserie · Kuchen-/Ausstech formen, vierecking  
Square pastry mould · Molde quadrado

Ref	€	cm	h (cm)	U.Venta
68460	4,70	6x6	4	12
68480	4,80	8x8	4	12
68411	4,90	10x10	4	12
68441	5,20	14x14	4	6
68240	6,60	20x20	4	6



#### Aro redondo VACHERIN

Cercle rond · Kuchen-/Ausstechformen, rund  
Round cake ring · Aro redondo

Ref	€	Ø (cm)	h (cm)	U.Venta
68607	4,20	7	6	12
68608	4,30	8	6	12
68609	4,40	9	6	12
68610	4,60	10	6	12
68612	6,10	12	6	6
68614	7,10	14	6	6
68616	9,70	16	6	6
68618	10,90	18	6	1
68620	14,10	20	6	1
68622	15,00	22	6	1
68624	16,20	24	6	1
68626	17,30	26	6	1
68628	18,90	28	6	1



Inox 18/10

Inox 18/10



#### Juego aros repostería

Ensemble de cercles à pâtisserie · Ausstechformen, Set  
Pastry rings set · Jogo aros de pasteleria

Ref	€	Forma	cm	h (mm)	U.Venta
68203	10,80	Redondo · Round	Ø7,7	5	1
		Redondo · Round	Ø10,7	5	
		Cuadrado · Square	8,2x8,2	5	
		Triángulo · Triangle	6x6	5	

Inox 18/10



#### Aro tarta borde vuelto

Cercle "goutte" · Tortenning  
Tart ring · Aro torta

Ref	€	Ø (cm)	h (cm)	U.Venta
68107	3,60	8	2,2	6
68121	3,80	10	2,2	6
68120	7,60	20	2,2	1



#### Aro repostería extensible

Cercle extensible · Kuchenform, verstellbar  
Adjustable pastry ring · Aro extensível pasteleria

Ref	€	Ø (cm)	h (cm)	U.Venta
68200	17,70	16-30	7,0	1

Inox 18/10



#### Aro cuadrado perforado

Cercle carre perforee · Kuchen-/Ausstechformen, vierecking, gelocht  
Perforated square cake ring · Aro quadrado perforada

Ref	€	cm	h (cm)	U.Venta
68557	3,70	7x7	2,0	6
68556	6,10	16x16	2,0	6
68560	7,60	20x20	2,0	6
68567	5,00	7x7	3,5	6
68566	9,60	16x16	3,5	6
68570	11,70	20x20	3,5	6

Inox 18/10



#### Aro rectangular perforado

Cercle rectangulaire perforee · Kuchen-/Ausstechformen, rechteckig, gelocht  
Perf. rectangular cake ring · Aro rectangular perf.

Ref	€	cm	h (cm)	U.Venta
68590	5,20	7x20	2,0	6
68598	6,40	8x28	2,0	6
68591	7,90	7x20	3,5	6
68597	10,40	8x28	3,5	6

Inox 18/10



#### Aro redondo perforado

Cercle rond perforee · Kuchen-/Ausstechformen, rund, gelocht  
Perforated round cake ring · Aro redondo perforada

Ref	€	Ø (cm)	h (cm)	U.Venta
68537	3,10	7	2,0	6
68532	3,90	12	2,0	6
68536	5,00	16	2,0	6
68538	5,50	18	2,0	6
68540	6,30	20	2,0	6
68544	7,60	24	2,0	6
68558	8,50	28	2,0	6

68547	4,30	7	3,5	6
68552	6,30	12	3,5	6
68546	7,70	16	3,5	6
68548	8,60	18	3,5	6
68550	9,60	20	3,5	6
68554	11,50	24	3,5	6
68568	13,50	28	3,5	6

Inox 18/10



#### Aro oval perforado

Cercle oval perforee · Kuchen-/Ausstechformen, oval, gelocht  
Perforated oval cake ring · Aro oval perforada

Ref	€	cm	h (cm)	U.Venta
68580	5,00	7x20	2,0	6
68588	6,30	8x28	2,0	6
68581	7,20	7x20	3,5	6
68587	9,90	8x28	3,5	6

## New



#### Aro corazón perforado

Cercle coeur perforee · Kuchen-/Ausstechformen, gelocht  
Perforated heart ring · Aro coração perforada

Ref	€	Ø (cm)	h (cm)	U.Venta
68488	3,00	8	2,0	6
68482	4,50	12	2,0	6



#### Aro hoja perforado

Cercle feullere perforee · Kuchen-/Ausstechformen, gelocht  
Perforated Eal ring · Aro folha perforada

Ref	€	cm	h (cm)	U.Venta
68492	3,40	12x5	2,0	6
68498	4,40	18x7,8	2,0	6



08

Eléctrico  
Electric





# CookingMe

## Robot de cocina

Semiprofessional use



### ES

- Diseñado para hacerte el día a día más fácil en tu cocina.
- Realiza todas tus recetas de manera rápida y sin esfuerzo.
- Múltiples funciones: cocer, sofreír, picar, triturar, cocer al vapor, mezclar, batir, amasar, emulsionar y pesar, solo tienes que darle la orden.
- Panel de control de fácil manejo.
- Incluye accesorios para elaborar todo tipo de recetas.

### FR

- Conçu pour vous faciliter la tâche dans votre cuisine quotidienne.
- Il réalise toutes les recettes de manière rapide et sans effort.
- Multiples fonctions : cuire, saisir, hacher, broyer, cuire à la vapeur, mélanger, mixer, pétrir, émulsionner et peser, vous n'avez qu'à lui donner l'ordre.
- Tableau de commande facile à manœuvrer.
- Il inclut les accessoires pour élaborer tout type de recettes.

### EN

- Designed to make everyday life easier in your kitchen.
- Makes all your recipes quickly and effortlessly.
- Multiple functions: cook, sauté, chop, shred, steam, mix, beat, knead, emulsify and weigh, you just have to give the order.
- Easy-to-use control panel.
- Includes accessories to make all kinds of recipes.

### TODO EN UNO · ALL-IN-ONE



### CookingMe

Ref	€	U.Venta	
69561E	849,00	1	CookingMe + Recetario en ESPAÑOL · Recipe book in SPANISH
69561F	849,00	1	CookingMe + Recetario en FRANCÉS · Recipe book in FRENCH
69561I	849,00	1	CookingMe + Recetario en INGLÉS · Recipe book in ENGLISH

Ref	Tensión/ Voltage	Potencia/Power	Velocidad Speed	Temp./Temp.	Capacidad capacity	Funciones/Memorias Functions/Memories	Báscula Scale	Dimensiones Sizes	Peso/Weight
69561E	220-240 V; 50/60 Hz	Motor:1000 W Calent./Heating:1000 W	60 - 10.000 r.p.m	37°C - 120°C	2,0 L	15 / 3	5 Kg (div.: 1 g)	39x30x33 cm	7,80 Kg

### Accesorios · Accessoires · Accessories



#### Recetario

Cookbook · Kochbuch  
Cookbook · Livro de receitas

Ref	€	U.Venta	
R69561N	31,00	1	Español · Spanish
R69561P	31,00	1	Francés · French
R69561Q	31,00	1	Inglés · English



#### Jarra

Pitcher · Kanne  
Picher · Jarra

Ref	€	L	U.Venta
R69561A	180,40	2,0	1



#### Tapa para jarra

Couvercle pour picher · Deckel für Kanne  
Lid for picher · Tampa para jarra

Ref	€	U.Venta
R69561E	14,60	1



#### Vaso dosificador

Verre doseur · Dosierbecher  
Measuring glass · Copo dosificador

Ref	€	ml	U.Venta
R69561W	2,50	100	1



#### Cestillo colador

Panier passoire vapeur · Dampfsieb  
Steam strainer basket · Cesto coador

Ref	€	U.Venta
R69561C	17,60	1



#### Anilla fijación/bloqueo

Anneau de fixation/verrouillage · Dichtungsring/Arretierung  
Fixing ring · Anilla de fixação/bloqueio

Ref	€	U.Venta
R69561Z	2,50	1



#### Cuchillas

Couteaux · Klinge  
Blades · Lâminas

Ref	€	U.Venta
R69561B	35,10	1



#### Amasador

Accessoire à pétrir · Kneteinsatz  
Kneader · Acessório para amassar

Ref	€	U.Venta
R69561V	29,00	1



#### Emulsionador

Fouet · Rührraufsatz (Schmetterlig)  
Emulsifier · Batedor de borboleta

Ref	€	U.Venta
R69561T	4,80	1

No incluida / Not included



#### Vaporera

Ensemble vapeur · Dampfeinsatz  
Steam · Conjunto de vapor

Ref	€	U.Venta
R69561D	84,30	1

Accesorios aptos para la limpieza en el lavavajillas · Accessoires adaptés au nettoyage au lave-vaisselle · Accessories suitable for cleaning in the dishwasher



Pan y masas  
Bread and pasta



Salsas  
Sauces



Sopas  
Soups



Verduras  
Vegetables



Pescados  
Fish



Carnes  
Meats



Bebidas  
Drinks



Postres  
Desserts

# WHITE Arrocera

· Household use ·



Marcaje interior en la cubeta  
Marking inside the cuvette

ES

- Cubeta interna extraíble con recubrimiento antiadherente 100% ECO y libre de PFOA.
- Cestillo de vapor removible para cocer verduras, patatas, pescado, etc.
- Incluye cuchara y vaso medidor.
- Tapa fabricada en vidrio con salida de vapor para evitar la cocción excesiva de los alimentos.
- Función de conservación del calor y protección contra la ebullición en seco.
- Luces indicadoras para cocinar y mantener caliente.
- 100% estable gracias a sus pies antideslizantes.
- Muy fácil de limpiar.

FR

- Cuve interne extractible avec revêtement antiadhésif 100% ECO et sans PFOA.
- Panier de vapeur amovible pour cuire des légumes, des pommes de terre, du poisson, etc.
- Inclut une cuillère et un verre doseur.
- Couvercle fabriqué en verre avec sortie de vapeur pour éviter la cuisson excessive des aliments.
- Fonction de conservation de la chaleur et protection contre l'ébullition à sec.
- Témoins lumineux pour cuire et maintenir au chaud.
- 100% stable grâce à ses pieds antidérapants.
- Très facile à nettoyer.

EN

- Removable inner pot with 100% ECO PFOA free non-stick coating.
- Removable steam basket to cook vegetables, potatoes, fish, etc.
- Includes spoon and measuring cup.
- Lid made of glass with steam outlet to prevent overcooking.
- Warm function and boil-dry protection.
- Cook and Warm indicator lights.
- 100% stability thanks to its non-slip feet.
- Very easy to clean.



## Arrocera

Cuiseur à riz · Reiskocher  
Rice cooker · Arrozeira/vaporeira



· Professional use ·

No incluye vaporera  
Steam not included

Ref	€	W	L	U.Venta
69441	45,80	400	1,00	1
<b>A</b> 69233	52,50	700	1,80	1
<b>B</b> 69346	187,10	1300	3,6	1
R69346F	14,90	-	-	1

**New**

Vaporera · Steam

Ref	Tensión/Voltage	Potencia/Power	Capacidad/Capac.	Raciones/Servings	Medidor/Glass	Dimensiones Sizes	D. con vaporera Sizes with steam	Peso Weight
69441	220-240 V; 50/60 Hz	400 W	1,00 L	5	150 g arroz (rice) 160 ml agua (water)	27,5x23,5x28,5 cm	27,5x23,5x22 cm	1,80 Kg
69233	220-240 V; 50/60 Hz	700 W	1,80 L	10	150 g arroz (rice) 160 ml agua (water)	32x28,5x30,5 cm	32x28,5x30,5 cm	2,30 Kg
69346	220-240 V; 50/60 Hz	1300 W	3,60 L	20	150 g arroz (rice) 160 ml agua (water)	41,5x35x30 cm	-	3,75 Kg

# TRI & SIX OVUM Cocedor de huevos

· Household use ·



ES

- Fabricados con base de acero inoxidable 18/10 y tapa transparente libre de BPA.
- Diseñados para cocinar huevos de diferentes tamaños y en 3 formas diferentes: huevo duro, huevo mollet o huevo pasado por agua.
- Capacidad para cocer hasta 3 huevos a la vez (69343-Tri Ovum).
- Capacidad para cocer hasta 6 huevos a la vez (69344-Six Ovum).
- Apagado automático y señal acústica automática al terminar el proceso de cocción.
- Incluyen un vaso medidor (70 ml) con perforador que indica la cantidad de agua que hay que introducir.
- Totalmente desmontables y muy fácil de limpiar.

FR

- Fabriqués avec une base en acier inoxydable 18/10 et un couvercle transparent sans BPA.
- Conçus pour cuire des oeufs de différentes tailles et de 3 façons différentes : oeuf dur, oeuf mollet ou oeuf à la coque.
- Capacité pour cuire jusqu'à 3 oeufs à la fois (69343-Tri Ovum).
- Capacité pour cuire jusqu'à 6 oeufs à la fois (69344-Six Ovum).
- Arrêt automatique et signal sonore automatique à la fin du processus de cuisson.
- Inclut un verre doseur (70 ml) avec perforateur qui indique la quantité d'eau à mettre selon le type d'oeuf à faire cuire.
- Entièrement démontable et très facile à nettoyer.

EN

- Made with 18/10 stainless steel and a BPA free transparent lid.
- Designed for cooking different size eggs in three different ways, hard boiled, mollet eggs or soft boiled eggs.
- Capacity for making up to 3 (69343) / 6 (69344) eggs at once.
- Automatic shut-off and beeps when the boiling process is done.
- Includes a measuring cup (70ml) with a perforator that shows the amount of water to use depending on the kind of eggs you want to make.
- Can be completely disassembled and it's very easy to clean.



## Cocedor de huevos TRI OVUM

Cuiseur à oeufs · Eierkocher  
Egg cooker · Máquina de cozer ovos

Ref	€	W	Capac.	U.Venta
69343	23,90	210	3 huevos	1

Ref	Tensión/Voltage	Potencia/Power	Capacidad/Capacity	Cap. vaso/Glass cap.	Dimensiones/Sizes	Peso/Weight
69343	220-240 V; 50/60 Hz	210 W	3 huevos · eggs	70 ml	20,2x8,6x13,5 cm	0,60 Kg
69344	220-240 V; 50/60 Hz	210 W	6 huevos · eggs	70 ml	23,5x13x14 cm	1,12 Kg



## Cocedor de huevos SIX OVUM

Cuiseur à oeufs · Eierkocher  
Egg cooker · Máquina de cozer ovos

Ref	€	W	Capac.	U.Venta
69344	34,40	210	6 huevos	1



# SALCHICHAS

## Cocedor · Asador

Professional use



### Cocedor de salchichas

Machine à hot-dogs · Hot dog Wärmer  
Sausage cooker · Máquina de cozer salsichas

Ref	€	W	L	U.Venta
69543	464,00	540	1,0	1

- Fabricada en acero inoxidable de alta calidad.
- Ideal para cocinar al vapor salchichas, mazorcas de maíz, etc.
- Amplia cubeta de cristal y 3 pinchos para calentar los panecillos o bollos.
- Termostato regulable. Calentamiento rápido y efectivo.
- Dos interruptores independientes para cocinar simultáneamente o por separado las salchichas y los panes.
- NO necesita aceite ni grasa.
- Pies de goma antideslizantes para una mayor estabilidad.

- Fabriquée en acier inoxydable de grande qualité.
- Idéale pour cuire à la vapeur des saucisses, des épis de maïs, etc.
- Grand cylindre en verre et 3 plots pour faire chauffer les petits pains.
- Thermostat réglable. Chauffe rapide et efficace.
- Deux interrupteurs indépendants pour faire cuire simultanément ou séparément les saucisses et les pains.
- Ne nécessite ni huile ni graisse.
- Pieds en caoutchouc antidérapant pour une meilleure stabilité.

- Made of high quality stainless steel.
- Perfect for steaming sausages, corn on the cob, etc.
- The large glass pan and three sticks for heating buns.
- Adjustable thermostat, fast and effective heating.
- Two independent switches for cooking sausages and buns simultaneously or separately.
- Does not need oil or grease.
- Rubber non-slip feet for greater stability.

Ref	Tensión/Voltage	Potencia/Power	Temperatura/Temperature	Capacidad/Capacity	Altura tubos pan/Bread tube height	Contenedor/Container	Cestillo/Basket	Dimensiones/Sizes	Peso/Weight
69543	220-240 V; 50/60 Hz	540 W	35°C - 100°C	1,0 L	18 cm	Ø20x24 cm	Ø17x21 cm	24x50x38,5 cm	10 Kg



### Asador de salchichas

Grill à hot-dogs · Würstchengrill  
Sausage roaster · Assador de salsichas

Ref	€	W	U.Venta
69547	520,80	590	1

- Fabricado en acero inoxidable de alta calidad
- Posibilidad de asar y calentar simultáneamente cualquier tipo de salchicha.
- Ideal para cualquier restaurante, bar, food truck, etc.
- Parrilla con 7 rodillos con rotación de 360° para asegurar una cocción uniforme de los alimentos.
- 2 zonas de cocción con reguladores de temperatura independientes.
- Fácil limpieza. Bandeja de goteo extraíble.
- Pies de goma antideslizantes para una mayor estabilidad.

- Fabriqué en acier inoxydable de grande qualité.
- Possibilité de cuire et faire chauffer simultanément tout type de saucisse.
- Idéal pour les restaurants, bars, food trucks, etc.
- Grill avec 7 rouleaux rotatifs à 360° pour garantir une cuisson uniforme des aliments.
- 2 espaces de cuisson avec thermostats indépendants.
- Nettoyage facile. Plateau recueille-gouttes extractible.
- Pieds en caoutchouc antidérapant pour une meilleure stabilité.

- Made of high quality stainless steel
- Any kind of sausage can be grilled or heated simultaneously
- Perfect for any restaurant, bar, food truck, etc.
- Grill with 7 rollers with 360° rotation to ensure food is cooked uniformly
- Two cooking areas with independent temperature regulators
- Easy to clean Removable drip tray
- Rubber non-slip feet for greater stability

Ref	Tensión/Voltage	Potencia/Power	Temperatura/Temp.	Tubos/Tubes	Distancia entre tubos		Dimensiones/Sizes	Peso/Weight
					Dist. between tubes			
69547	220-240 V / 50 Hz	590 W	30°C - 170°C	50 cm	1 cm		65x35,5x28 cm	10.5 Kg

# WHITE

## Panificadora

Household use



Click here



ES

- Amasa, fermenta y hornea todo tipo de panes gracias a sus 12 programas.
- Incluye programas especiales para preparar pan sin gluten, pan de trigo o masa para pizza.
- Producto versátil; permite escoger entre panes de 700g o 1000 g y seleccionar 3 niveles de tostado.
- Fácil de usar; dispone de un selector de programas y un selector de tiempo.
- Panel de control intuitivo con todos los parámetros indicados en una pantalla LCD.
- Cubeta antiadherente extraíble, no apta para el lavavajillas.
- Exterior resistente al calor y con protección contra el sobrecalentamiento.

FR

- Pétrit, fermente et cuisine tout type de pains grâce à ses 12 programmes.
- Inclut des programmes spéciaux pour préparer du pain sans gluten, du pain au blé ou de la pâte à pizza.
- Produit polyvalent : permet de choisir entre des pains de 700 g ou de 1000 g et de sélectionner 3 niveaux de brunissage.
- Facile à utiliser : dispose d'un sélecteur de programmes et d'un sélecteur de temps.
- Écran de contrôle intuitif avec tous les paramètres indiqués sur un écran LCD.
- Cuve antiadhésive extractible, non apte pour le lave-vaisselle.
- Extérieur résistant à la chaleur et disposant d'une protection contre la surchauffe.

EN

- Knead, ferment and bake all kinds of bread thanks to its 12 programmes.
- It includes special programmes for creating gluten-free or wholemeal bread, or even pizza dough.
- Versatile: it allows you to choose between 700 g and 1000 g bread and 3 different crust colours.
- Easy to use: it has a programme selector and a time selector.
- Intuitive control panel with an LCD screen that displays all of the settings.
- Non-stick baking pan that can be removed, but is not suitable for dishwashers.
- Heat-resistant exterior that is protected against overheating.



### Panificadora automática

Machine à pain · Brotbackmaschine  
Bread-making machine · Máquina de fazer pão

Ref	€	W	L	U.Venta
69334	142,70	550	1,0	1



Ref	Tensión/Voltage	Potencia/Power	Capacidad/Capacity	Funciones/Functions	Temporizador/Timer	Dimensiones/Sizes	Peso/Weight
69334	220-240 V; 50/60 Hz	550 W	1,0 L	12	13 horas · hours	36x24,5x28 cm	4,50 Kg

# YOGURTERAS

## Colección

Household use



ES

- Diseñadas para elaborar yogur, kéfir, yogur griego y queso fresco casero de la textura y sabor que desees. Más sanos y naturales.
- Prácticas y muy fáciles de usar. Supersilenciosas.
- Tiempo de preparación de 8-14 h.
- Apagado automático con señal acústica al finalizar el proceso.
- Incluyen un práctico recetario para elaborar todo tipo de yogures, queso fresco y kéfir.

FR

- Conçue pour préparer du yaourt, Kéfir, yaourt grec et fromage blanc fait maison avec la texture et le goût. Plus sain et plus naturel.
- Pratiques et très faciles à utiliser. Très silencieuses.
- Durée de préparation : 8-14 h.
- Arrêt automatique avec signal sonore à la fin de la préparation.
- Inclut un livre de recettes pour préparer tous types de yaourts, fromages blancs et kéfirs.

EN

- Designed to make yoghurt or homemade kefir with the texture and flavour of your choice. Healthier and more natural.
- Practical and very easy to use. Super silent.
- Preparation time 8-14 h.
- Switches off automatically with an audible beep at the end of the process.
- Includes a practical recipe booklet for making all kinds of yoghurt, fresh cheese and kefir.



7 tarros de cristal  
7 glass jars

### Yogurtera de vasos MULTI

Yaourtière à pots · Joghurt-Maker mit Glasbehältern  
Yoghurt maker with jars · logurteira de frascos

Ref	€	W	U.Venta
69245	45,40	20	1



### Set 7 tarros

Set 7 bocaux · 7-Tlg. Gläser ein  
Set 7 jars · Conjunto de 7 potes

Ref	€	U.Venta
69244	10,90	7
R69245B	1,50	7

Set 7 tarros cristal · Set 7 glass jar

Tarro de cristal · Glass jar

Ref	Tensión/Voltage	Potencia/Power	Temporizador/Timer	Capacidad/Capacity	Dimensiones/Sizes	Peso/Weight
69245	220-240 V; 50/60 Hz	20 W	1 -14 h	190 ml	Ø25x12 cm	1,80 Kg

New



### Yogurtera de vasos DEVA

Yaourtière à pots · Joghurt-Maker mit Glasbehältern  
Yoghurt maker with jars · logurteira de frascos

Ref	€	W	U.Venta
69439	60,20	40	1
A 69438	15,40	-	9

Ref	Tensión/Voltage	Potencia/Power	Temperatura/Temp.	Capacidad/Capacity	Vasos/Jars	Dimensiones/Sizes	Peso/Weight
69439	220-240 V; 50-60 Hz	40 W	25°C - 65°C	170 ml (9)	9	26x24,6x13,5 cm	10,30 Kg

- Ideal para preparar deliciosos yogures caseros naturales y saludables.
- Incluye 9 tarros de vidrio extraíbles con capacidad de 170 ml y tapa hermética.
- Temperatura ajustable entre 25°C - 65°C y temporizador hasta 99 horas.
- Carcasa rectangular de acero inoxidable y tapa transparente para controlar el proceso de elaboración.
- Apagado automático y señal acústica al final de la preparación.
- Pantalla digital con retroiluminación.
- Pies de goma antideslizantes.
- 100% libre de BPA.
- Fácil limpieza. Tarros y tapas aptos para el lavavajillas.

- Idéale pour préparer de délicieux yaourts faits maison, naturels et sains. Inclut 9 pots en verre extractibles d'une capacité de 170 ml et couvercle hermétique.
- Température réglable de 25°C à 65°C et minuteur jusqu'à 99 heures.
- Structure rectangulaire en acier inoxydable et couvercle transparent pour surveiller le processus d'élaboration.
- Arrêt automatique et signal sonore à la fin de la préparation.
- Écran digital rétroéclairé.
- Pieds en caoutchouc antidérapant.
- 100% sans BPA.
- Nettoyage facile. Pots et couvercles aptes pour le lave-vaisselle.

- Ideal for making delicious, natural and healthy homemade yoghurts.
- Includes 9 separate 170 ml capacity jars with airtight lids.
- Programmable 25°C - 65°C temperature settings and 99-hour timer.
- Rectangular stainless steel casing and transparent lid to control the process.
- Automatic switch-off and audible beep at the end of the process.
- Digital display with backlight.
- Non-slip rubber feet.
- 100% BPA free.
- Easy to clean. Dishwasher safe jars and lids.



### Yogurtera WHITE

Yaourtière · Joghurt-Maker  
Yoghurt maker · logurteira

Ref	€	W	U.Venta
69246	39,60	20	1

### Yogurtera MAXI

Yaourtière · Joghurt-Maker  
Yoghurt maker · logurteira

Ref	€	W	L	U.Venta
69243	40,50	20	2,0	1

### Yogurtera HERA

Yaourtière · Joghurt-Maker  
Yoghurt maker · logurteira

Ref	€	W	L	U.Venta
69345	38,80	20	1,0	1

Ref	Tensión/Voltage	Potencia/Power	Capacidad/Capacity	Dimensiones/Sizes	Peso/Weight
69246	220-240 V; 50/60 Hz	20 W	1,0 L (Filtro · Filter) 1,6 L (Pequeño · Small) 1,8 L (Grande · Big)	18x16x24 cm	0,85 Kg
69243	220-240 V; 50/60 Hz	20 W	2,0 L	Ø20x23 cm	1,17 Kg
69345	220-240 V; 50/60 Hz	20 W	1,0 L	Ø16,8x18,8 cm	0,70 Kg

# MÁQUINAS HELADO

## Colección

· Household use ·



### Máquina de helado MyCream

Machine de crème glacée - Eis Maschine  
Ice cream machine - Máquina de gelado

Ref	€	W	L	U.Venta
69315	468,30	150	1,40	1



- Una nueva forma de hacer helado cremoso y saludable.
  - Puedes realizar infinidad de helados de; fresa, plátano, kiwi, mango, piña, melón, etc.
  - Ideal para dietas especiales: sin leche, sin azúcar, sin gluten.
- Une nouvelle façon de faire des glaces crémeuses et saines.
  - Vous pouvez réaliser une infinité de glaces : à la fraise, à la banane, au kiwi, à la mangue, à l'ananas, à l'orange, au melon, etc.
  - Idéale pour les régimes alimentaires spéciaux : sans lait, sans sucre, sans gluten.
- A new way to make creamy and healthy ice cream.
  - You can make a wide variety of ice creams; strawberry, banana, kiwi, mango, pineapple, orange, melon, etc.
  - Ideal for special diets: milk-free, sugar-free, gluten-free.

Ref	Tensión/Voltage	Potencia/Power	Temperatura/Temp.	Capacidad/Capacity	Tiempo/Timer	Dimensiones/Sizes	Peso/Weight
69315	220-240 V / 50 Hz	150 W	-18°C / -35°C	1,40 L	60 min.	38x29x31 cm	10,30 Kg



### Accesorio para helado de frutas

Fruit ice cream accessory

2 en 1

5 cuchillas de colores  
5 colored blades



### Corta vegetales + máquina de helado COSMO

Hachoir légumes + machine à fruitcreme glacée - Gemüseschneider + Obst-Eis machine  
Vegetables cutter + ice fruit machine - Corta vegetales + máq. de gelado de fruta

Ref	€	W	U.Venta
69115	80,30	150	1

Ref	Tensión/Voltage	Potencia/Power	Cuchillas/Blades	Dimensiones/Sizes	Peso/Weight
69115	220-240 V; 50/60 Hz	150 W	6	24,5x22,5x19,5 cm	1,89 Kg



- Versátil: Procesador eléctrico de verduras con accesorio para hacer helado.
  - Incluye 6 cuchillas de corte (en formato cono) de acero inoxidable de máxima calidad para todo tipo de cortes; verdura, fruta, queso, frutos secos, chocolate, etc.
  - Incluye un accesorio diseñado para hacer helados y sorbetes con fruta congelada.
  - Rápido, intuitivo y muy fácil de usar.
  - Compacto: Práctico para usar y guardar; las cuchillas se almacenan en el interior.
  - 100% seguro: no hay contacto directo con las manos.
  - Funcionamiento silencioso.
  - Fácil de limpiar: accesorios aptos para el lavavajillas.
  - 100% Libre de BPA.
- Fully versatile: electric vegetable cutter with an ice cream attachment.
  - Includes 6 top quality stainless steel, cone-type cutting blades for all kinds of cuts; suitable for vegetables, fruit, cheese, nuts, chocolate, etc.
  - Comes with an attachment to make ice cream and sorbets from frozen fruit.
  - Very practical, quick and easy to use.
  - Compact: convenient to use and store; blades neatly stored inside.
  - 100% safe: no direct contact with hands.
  - Silent operation.
  - Easy to clean: dishwasher safe accessories.
  - 100% BPA free

Click here



# CORN

## Palomitera

· Household use ·



ES

- Prepara palomitas saludables sin necesidad de utilizar aceite, gracias a su sistema de cocción por aire caliente.
- Palomitas recién hechas en tan solo 3 minutos.
- Capaz de cocinar hasta 80 g de maíz por cada ciclo de trabajo.
- Incluye cuchara medidora para el maíz que te ayudará a calcular las raciones.
- Interruptor de encendido / apagado.
- Pies antideslizantes.

FR

- Préparer du pop-corn sain sans utiliser d'huile grâce au système de chauffe avec de l'air chaud.
- Pop-corn frais en seulement 3 minutes.
- Capable de transformer jusqu'à 80 g de maïs par cycle de travail.
- Inclut une cuillère-mesure pour le maïs qui aidera à calculer les portions.
- Interruption de marche / arrêt.
- Pieds antidérapants.

EN

- Prepare healthy popcorn without using oil thanks of its hot air cooking system.
- Fresh popcorn in just 3 minutes.
- It can pop up to 80g of corn in every cycle.
- A measuring spoon for corn is included to help you calculate servings.
- On/off switch.
- Non-slip feet.



### Palomitera

Machine à pop-corn - Popcorn-Maschine  
Popcorn maker - Máquina de fazer pipocas

Ref	€	W	g	U.Venta
69299	38,50	1000	80	1

Ref	Tensión/Voltage	Potencia/Power	Capacidad/Capacity	Dimensiones/Sizes	Peso/Weight
69299	220-240 V ; 50/60 Hz	1000 W	80 g	14,5x21,5x30 cm	0,870 Kg

# BATIDORAS AMASADORAS

## Colección



### Batidora amasadora PROFESIONAL

Batteur pétrisseur · Mix- und Knetmaschine  
Mixer-kneader · Batedeira amassadora

Ref	€	W	L	U.Venta
69084	864,50	300	5,0	1



· Professional use ·

- Batir, mezclar y amasar productos para la preparación de alimentos.
- Velocidad regulable, doble movimiento de giro, rotativo y orbital.
- Brazo basculante para acoplar los distintos accesorios.

- Batre, mélanger et pétrir des produits pour la préparation d'aliments.
- Vitesse réglable, double mouvement de rotation, rotatif et orbital.
- Bras pivotant pour fixer aisément les différents accessoires.

- Beat, mix and knead products to food preparation.
- Adjustable speed, double twisting, rotating and orbital motion.
- Swing arm for connection of different accessories.

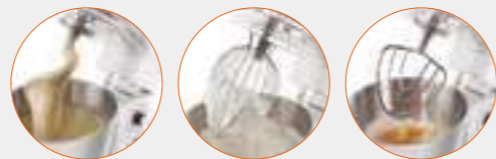

Ref	Tensión/Voltage	Potencia/Power	Velocidad/Speed	Velocidad/Speed	Capacidad/Cap.	Dimensiones/Sizes	Peso/Weight
69084	220-240 V; 50/60 Hz	300 W	3	130 - 850 r.p.m.	5,0 L	37 x 23,5 x 43 cm	19 Kg



Velocidades  
**6+PULSE**  
Speeds

1,2 Kg de cap. para el amasado  
1,2 kg mixer capacity

### Batidora amasadora GOURMET

Batteur pétrisseur · Mix- und Knetmaschine  
Mixer-kneader · Batedeira amassadora

Ref	€	W	L	U.Venta
69388	211,50	600	4,0	1



· Household use ·

- Regulador de velocidad para 6 velocidades y función PULSE (Turbo).
- Amasado con movimientos planetarios. Doble movimiento de giro, rotatorio y orbital.
- Brazo basculante de 35° para acoplar los distintos accesorios.
- Tapa transparente anti-salpicaduras con ventana para añadir ingredientes durante el uso.

- Régulateur de vitesse pour 6 vitesses et fonction PULSE (Turbo).
- Pétrissage avec des mouvements planétaires. Double mouvement de rotation, rotatoire et orbital.
- Bras pivotant de 35° pour fixer aisément les différents accessoires.
- Couvercle transparent anti-éclaboussures avec fenêtre pour ajouter les ingrédients pendant l'utilisation.

- Speed regulator with 6 speeds and a PULSE (Turbo) function.
- Mixer with planetary motion. Twin twisting, rotational and orbital movement.
- 35° swing arm for connection of different accessories.
- Transparent anti-splatter lid with opening for adding ingredients during use.

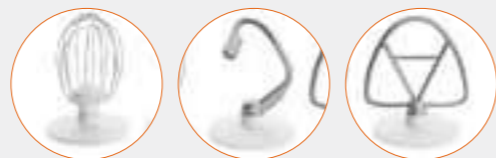

Ref	Tensión/Voltage	Potencia/Power	Velocidad/Speed	Velocidad/Speed	Capacidad/Cap.	Dimensiones/Sizes	Peso/Weight
69388	220-240 V; 50/60 Hz	600 W	6	60 - 180 r.p.m.	4,0 L	35x22x30 cm	4,40 Kg



3 en 1

· Semiprofessional use ·



### Accesorio jarra

Accessoire cruche · Krugzubehör  
Jug accessory · Acessório de jarro

Ref	€	L	U.Venta	
A 69584	27,20	1,5	1	Batidora amasadora DELICY
B 69684	27,20	1,5	1	Batidora amasadora COMPLET



### Accesorio picadora/embutidora/kibbe

Accessoire hachoir/stuffer/kibbe · Fleischwolf/Wurstfüller/Kibbe Zubehör  
Chopper/stuffer/kibbe accessory · Acessório picador/stuffer /kibbe

Ref	€	L	U.Venta
69685	57,60	1,5	1



Velocidades  
**5+PULSE**  
Speeds

### Batidora amasadora DELICY

Batteur pétrisseur · Mix- und Knetmaschine  
Mixer-kneader · Batedeira amassadora

Ref	€	W	L	U.Venta
69583	354,80	1000	5,0	1



Velocidades  
**6+PULSE**  
Speeds

### Batidora amasadora COMPLET

Batteur pétrisseur · Mix- und Knetmaschine  
Mixer-kneader · Batedeira amassadora

Ref	€	W	L	U.Venta
69683	382,10	1500	6,0	1

- Amasado con movimientos planetarios. Doble movimiento de giro, rotatorio y orbital. Mecanismo de engranajes metálicos.
- Brazo basculante de 35° para acoplar los distintos accesorios.
- Bol de acero inoxidable 18/10 de 5 L (69583) / 6 L (69683) de capacidad.
- Tapa transparente antisalpicaduras con ventana para añadir ingredientes durante el uso.
- 3 accesorios para batir, mezclar y amasar. Recubrimiento antiadherente de los accesorios mezclador y amasador para evitar que los alimentos se peguen.
- Ventosas de sujeción para una perfecta estabilidad.
- Accesorios no incluidos (jarra y picadora) compatibles para conseguir un robot multifuncional.

- Pétrissage avec des mouvements planétaires. Double mouvement de rotation, rotatoire et orbital. Mécanisme d'engrenages métalliques.
- Bras pivotant de 35° pour fixer aisément les différents accessoires.
- Bol en acier inoxydable 18/10 d'une capacité de 5 L (69583) / 6 L (69683).
- Couvercle transparent anti-éclaboussures avec fenêtre pour ajouter les ingrédients pendant l'utilisation.
- 3 accessoires pour battre, mixer et pétrir. Revêtement antiadhésif de l'accessoire pour mélanger et pétrir afin d'éviter que les aliments collent.
- Ventouses de fixation pour une bonne stabilité.
- Accessoires non inclus (jug and mincer) compatibles pour obtenir un robot multifonctions.

- Mixer with planetary motion. Twin twisting, rotational and orbital movement. Mechanism of metal gears.
- 35° swing arm for connection of different accessories.
- 18/10 stainless steel bowl with 5 L (69583) / 6 L (69683) capacity.
- Transparent anti-splatter lid with opening for adding ingredients during use.
- 3 accessories for whisking, mixing and kneading. Non-stick coating on the mixer and kneading accessories to prevent food from sticking.
- Suction pads for good stability.
- Non included accessories (jug and mincer) can be added to create a multifunctional kitchen robot.

Ref	Tensión/Voltage	Potencia/Power	Velocidades/Speeds	Veloc. Amasadora/Kneading speed	Velocidad jarra/Jug speed	Veloc. picadora/Mincer speed	Capacidad/Capacity	Dimensiones/Sizes	Peso/Weight
69583	220-240 V; 50/60 Hz	1000 W	5	128 - 540 r.p.m.	3.200 - 13.500 r.p.m.	41 - 172 r.p.m.	5,0 L	32,5x25x36,5 cm	6,35Kg
69683	220-240 V; 50/60 Hz	1500 W	6	117 - 606 r.p.m.	2.600 - 13.500 r.p.m.	37 - 195 r.p.m.	6,0 L	40x25,5x33,5 cm	7,00 Kg

# BATIDOS · CÓCTELES

## Batidora

Professional use



**Batidora**  
Batteur · Mixer  
Blender · Batedeira

Ref	€	U.Venta
69111	282,30	1

- Batidora ideal para elaborar batidos y cócteles.
- Con soporte para enganchar el vaso batidor.
- Interruptor par control de velocidad.
- Vaso en de acero inoxidable con capacidad de 0,6 litros.

- Mixeur idéal pour préparer des smoothies et des cocktails.
- Avec un support pour fixer le gobelet du mixeur.
- Interrupteur pour le contrôle de la vitesse.
- Gobelet en acier inoxydable d'une capacité de 0,6 litre.

- Ideal blender for making smoothies and cocktails.
- With a holder for attaching the blender beaker.
- Switch for speed control.
- Stainless steel beaker with a capacity of 0.6 litres.

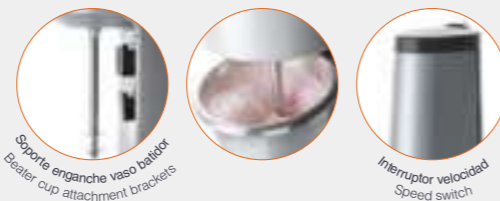

Soporte enganche vaso batidor  
Beater cup attachment brackets

Interruptor velocidad  
Speed switch

Ref	Tensión/Voltage	Potencia/Power	Velocidad/Speed	Capacidad/Capacity	Dimensiones/Sizes	Peso/Weight
69111	220-240 V / 50-60 Hz	400 W	10.000 - 15.000 r.p.m.	0,60 L	21x15x51 cm	6,20 Kg



# BATIDORES VARILLAS

## Colección

Household use

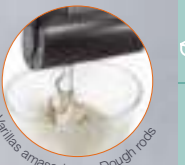

Varillas batidoras · Beater rods

Varillas amasadoras · Dough rods

ES

- Ideal para batir, mezclar y amasar fácilmente todo tipo de preparaciones reposteras de manera fácil y eficiente.
- Potente, silencioso y ligero para una mayor comodidad durante el uso.
- Empuñadura ergonómica; permite realizar la mezcla de manera segura y firme.
- Incluye 2 varillas batidoras y 2 varillas amasadoras.
- Extrae las varillas fácilmente con el botón de expulsión.

FR

- Idéal pour battre, mélanger et pétrir facilement tout type de préparations pâtisseries de façon facile et efficace.
- Puissant, silencieux et léger pour une plus grande praticité d'utilisation.
- Manche ergonomique ; qui permet de réaliser le mélange de façon sûre et nette.
- Inclut 2 fouets pour battre et 2 fouets pour pétrir.
- Extraction des fouets facile avec le bouton d'expulsion.

EN

- It's perfect for whipping, mixing and kneading all kinds of confectionery preparations quickly and easily.
- It's powerful, quiet and lightweight for greater comfort during use.
- The ergonomic handle lets you do the mixture safely and firmly.
- Two whisks and two kneading paddles included.
- Remove the accessories easily with the eject button.



### Batidora de varillas HOME

Batteur à main · Handmixer  
Hand mixer · Batedor de mão

Ref	€	W	U.Venta
69384	47,10	300	1



### Batidora de varillas TitanPro

Batteur à main · Handmixer  
Hand mixer · Batedor de mão

Ref	€	W	U.Venta
69374	52,90	350	1

Display incorporado;  
indica la velocidad  
seleccionada  
y el tiempo de uso  
The built-in display  
shows the selected  
speed and usage time

Ref	Tensión/Voltage	Potencia/Power	Velocidad/Speed	Capacidad/Capacity	Dimensiones/Sizes	Peso/Weight
69384	220-240 V; 50/60 Hz	300 W	5 + TURBO	1000 g	18x8x14 cm	1,20 Kg
69374	220-240 V; 50/60 Hz	350 W	5 + TURBO	1000 g	14,5x8,5x19 cm	1,25 Kg

# BRISK

## Batidora Profesional

Professional use



Rápida · Fast  
Eficiente · Efficient  
Robusta · Robust

### ES

- Fabricado en materiales altamente resistentes y de máxima calidad.
- El mango ergonómico ofrece mayor seguridad y control de la batidora.
- Indicado para trabajar en ollas de hasta 10 litros de capacidad.
- Los brazos trituradores, batidores y cuchillas, fabricados en acero inoxidable.
- Colocación y desmontaje sencillo e instantáneo, sin necesidad de utilizar herramientas.
- Prepara purés, cremas y todo tipo de salsas.

### FR

- Fabriqué avec des matériaux hautement résistants et d'une qualité maximale.
- Le manche ergonomique offre une sécurité et un contrôle accru du mixeur.
- Indiqué pour travailler dans des marmites de jusqu'à 10 litres de contenance.
- Accessoires pour hacher, mixer, couper, fabriqués en acier inoxydable.
- Installation et démontage simple et instantané, sans utilisation d'outils supplémentaires.
- Permet de préparer des purées, des crèmes et tout type de sauces.

### EN

- Made from highly resistant materials of the highest quality.
- The ergonomic handle provides greater safety and control of the blender.
- Suitable for working in pots up to 10 litres.
- The shredders, beaters and blades are made of stainless steel.
- Fitting and removing is simple and instant, without using tools.
- Prepare soups, purées and all kinds of sauces.

Botón de uso continuo  
Continuous use button



Regulador de velocidad variable  
Variable speed controller

Brazo de fácil desmontaje en acero inoxidable  
Easy to remove arm made of stainless steel



Cuchilla de gran calidad para un óptimo trabajo  
High-quality blade for optimum work



Serie 270

Batidora para uso discontinuo · Mixeur pour une utilisation discontinue · Blender for discontinuous use

Velocidad Fija · Fixed Speed



### Batidor velocidad fija

Mixer vitesse fixe · Profi-mixer, Festschwindigkeit  
Immersion blender fixed speed · Batedeira velocidade fixa

Ref	€	W	U.Venta
69722	230,80	270	1

Velocidad Variable · Variable Speed



Regulador de velocidad variable  
Variable speed controller

### Batidor velocidad variable

Mixer vitesse variable · Profi-mixer, variable Geschwindigkeit  
Immersion blender variable speed · Batedeira velocidade variável

Ref	€	W	U.Venta
69723	246,80	270	1

Ref	Tensión/Voltage	Potencia/Power	Velocidad/Speed	Capacidad/Capacity	L.Brazo/Arm length	Peso/Weight
69722	220-240 V; 50/60 Hz	270 W	20.000 r.p.m	10 L	16 cm	1,50 Kg
69723	220-240 V; 50/60 Hz	270 W	4.000 - 20.000 r.p.m	10 L	16 cm	1,50 Kg

Accesorios · Accessoires · Accessories



### Brazo triturador

Pied mixeur · Rohr  
Shaft tube · Pé triturador

Ref	€	L (cm)	U.Venta
69816	117,40	16	1



### Brazo batidor

Fouet mélangeur · Rührbesen  
Whisk · Pé amassadora

Ref	€	L (cm)	U.Venta
69815	164,00	18,5	1

Inox 18/10

Incluye tacos y tornillos para su instalación  
Includes studs and screws for installation

A

B



Para serie 220 · For 220 series



### Set llaves desmontaje cuchillas

Outil montage lame set · Schüsselsatz zum Wechseln der Messer  
Blade disassembly tool set · Set ferrament desmontagem lâmina

Ref	€	U.Venta
R69722J	10,90	1



### Soporte batidora BRISK

Support mélangeur · Aufhängeleiste für Mixer  
Blender stand · Suporte para batedeira

Ref	€	L (cm)	h (cm)	ØVarilla (mm)	U.Venta
A 69801	8,80	7	5,5	5,0	1 Individual
B 69803	16,50	28	5,5	5,0	1 Triple



## Serie 350

Batidora para uso continuo · Mixeur pour une utilisation continue · Blender for continuous use

### Velocidad Fija · Fixed Speed



#### Batidor velocidad fija

Mixer vitesse fixe · Profi-mixer, Festdrehzahl  
Immersion blender fixed speed · Batedeira velocidade fixa

	Ref	€	Brazo (cm)	U.Venta
A	69761	301,50	20	1
B	69762	314,20	25	1
C	69763	326,80	30	1
D	69764	345,70	40	1
E	69765	370,70	50	1

### Velocidad Variable · Variable Speed

Regulador de velocidad variable  
Variable speed controller



#### Batidor velocidad variable

Mixer vitesse variable · Profi-mixer, variable Geschwindigkeit  
Immersion blender variable speed · Batedeira velocidade variável

	Ref	€	Brazo (cm)	U.Venta
A	69771	318,00	20	1
B	69772	330,60	25	1
C	69773	343,10	30	1
D	69774	361,80	40	1
E	69775	386,90	50	1



Ref	Tensión/Voltage	Potencia/Power	Velocidad/Speed	Capacidad/Capacity	L.Brazo/Arm length	Composición/Comp.	Peso/Weight
69761	220-240 V / 50-60 Hz	350 W	16.000 r.p.m	15 L	20 cm	69735: Motor/Motor 69820: Brazo/Arm	2,95 Kg
69762	220-240 V / 50-60 Hz	350 W	16.000 r.p.m	20 L	25 cm	69735: Motor/Motor 69825: Brazo/Arm	3,00 Kg
69763	220-240 V / 50-60 Hz	350 W	16.000 r.p.m	30 L	30 cm	69735: Motor/Motor 69830: Brazo/Arm	3,80 Kg
69764	220-240 V / 50-60 Hz	350 W	16.000 r.p.m	80 L	40 cm	69735: Motor/Motor 69840: Brazo/Arm	4,00 Kg
69765	220-240 V / 50-60 Hz	350 W	16.000 r.p.m	120 L	50 cm	69735: Motor/Motor 69850: Brazo/Arm	4,20 Kg
69771	220-240 V / 50-60 Hz	350 W	4.000 - 16.000 r.p.m	15 L	20 cm	69736: Motor/Motor 69820: Brazo/Arm	2,95 Kg
69772	220-240 V / 50-60 Hz	350 W	4.000 - 16.000 r.p.m	20 L	25 cm	69736: Motor/Motor 69825: Brazo/Arm	3,00 Kg
69773	220-240 V / 50-60 Hz	350 W	4.000 - 16.000 r.p.m	30 L	30 cm	69736: Motor/Motor 69830: Brazo/Arm	3,80 Kg
69774	220-240 V / 50-60 Hz	350 W	4.000 - 16.000 r.p.m	80 L	40 cm	69736: Motor/Motor 69840: Brazo/Arm	4,00 Kg
69775	220-240 V / 50-60 Hz	350 W	4.000 - 16.000 r.p.m	120 L	50 cm	69736: Motor/Motor 69850: Brazo/Arm	4,20 Kg

## Serie 500

Batidora para uso continuo e intensivo · Mixeur pour une utilisation continue et intensive · Blender for continuous and intensive use

### Velocidad Fija · Fixed Speed



#### Batidor velocidad fija

Mixer vitesse fixe · Profi-mixer, Festdrehzahl  
Immersion blender fixed speed · Batedeira velocidade fixa

	Ref	€	Brazo (cm)	U.Venta
A	69781	318,70	20	1
B	69782	331,30	25	1
C	69783	343,90	30	1
D	69784	362,60	40	1
E	69785	387,70	50	1

### Velocidad Variable · Variable Speed

Regulador de velocidad variable  
Variable speed controller



#### Batidor velocidad variable

Mixer vitesse variable · Profi-mixer, variable Geschwindigkeit  
Immersion blender variable speed · Batedeira velocidade variável

	Ref	€	Brazo (cm)	U.Venta
A	69791	333,20	20	1
B	69792	345,80	25	1
C	69793	358,20	30	1
D	69794	377,00	40	1
E	69795	402,10	50	1



Ref	Tensión/Voltage	Potencia/Power	Velocidad/Speed	Capacidad/Capacity	L.Brazo/Arm length	Composición/Comp.	Peso/Weight
69781	220-240 V / 50-60 Hz	500 W	16.000 r.p.m	30 L	20 cm	69750: Motor/Motor 69820: Brazo/Arm	3,55 Kg
69782	220-240 V / 50-60 Hz	500 W	16.000 r.p.m	40 L	25 cm	69750: Motor/Motor 69825: Brazo/Arm	3,60 Kg
69783	220-240 V / 50-60 Hz	500 W	16.000 r.p.m	60 L	30 cm	69750: Motor/Motor 69830: Brazo/Arm	4,40 Kg
69784	220-240 V / 50-60 Hz	500 W	16.000 r.p.m	100 L	40 cm	69750: Motor/Motor 69840: Brazo/Arm	4,60 Kg
69785	220-240 V / 50-60 Hz	500 W	16.000 r.p.m	140 L	50 cm	69750: Motor/Motor 69850: Brazo/Arm	4,80 Kg
69791	220-240 V / 50-60 Hz	500 W	4.000 - 16.000 r.p.m	30 L	20 cm	69751: Motor/Motor 69820: Brazo/Arm	3,55 Kg
69792	220-240 V / 50-60 Hz	500 W	4.000 - 16.000 r.p.m	40 L	25 cm	69751: Motor/Motor 69825: Brazo/Arm	3,60 Kg
69793	220-240 V / 50-60 Hz	500 W	4.000 - 16.000 r.p.m	60 L	30 cm	69751: Motor/Motor 69830: Brazo/Arm	4,40 Kg
69794	220-240 V / 50-60 Hz	500 W	4.000 - 16.000 r.p.m	100 L	40 cm	69751: Motor/Motor 69840: Brazo/Arm	4,60 Kg
69795	220-240 V / 50-60 Hz	500 W	4.000 - 16.000 r.p.m	140 L	50 cm	69751: Motor/Motor 69850: Brazo/Arm	4,80 Kg

Serie 350

Serie 500



**Motor batidor SERIE 350**

Moteur mixer SÉRIE 350 · Mixer Motor, SERIE 350  
Immersion blender motor, SERIE 350 · Motor bateadeira SÉRIE 350

Ref	€	W	U.Venta
A 69735	170,00	350	1 <b>Velocidad Fija</b> · Fixed Speed
B 69736	186,20	350	1 <b>Velocidad Variable</b> · Variable Speed

**Motor batidor SERIE 500**

Moteur mixer SÉRIE 500 · Mixer Motor, SERIE 500  
Immersion blender motor SERIE 500 · Motor bateadeira SÉRIE 500

Ref	€	W	U.Venta
A 69750	186,90	500	1 <b>Velocidad Fija</b> · Fixed Speed
B 69751	201,40	500	1 <b>Velocidad Variable</b> · Variable Speed

**Brazo triturador**

Pied mixeur · Rohr  
Shaft tube · Pé triturador

Ref	€	L (cm)	A (cm)	U.Venta
A 69820	131,80	20	12,5	1
B 69825	144,40	25	15,8	1
C 69830	156,80	30	19,2	1
D 69840	175,60	40	25,8	1
E 69850	200,70	50	32,5	1
F 69824	182,00	25	-	1

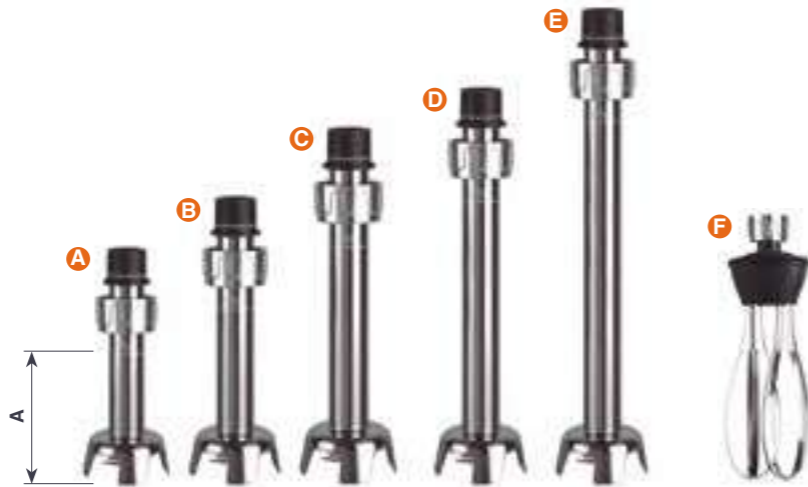

Para serie 350/500 · For 350/500 series



**Set llaves desmontaje cuchillas**

Outil montage lame set · Schüsselsatz zum Wechseln der Messer  
Blade disassembly tool set · Set ferrament desmontagem lâmina

Ref	€	U.Venta
R69735J	10,90	1



Incluye tacos y tornillos para su instalación  
Includes studs and screws for installation



**Soporte batidora BRISK**

Support mélangeur · Aufhängeleiste für Mixer  
Blender stand · Suporte para bateadeira

Ref	€	L (cm)	h (cm)	ØVarilla (mm)	U.Venta
A 69801	8,80	7	5,5	5,0	1 Individual
B 69803	16,50	28	5,5	5,0	1 Triple

**BAMIX**  
Batidora

Professional use



**bamix**



Incluye soporte pared para colgar  
Includes wall mount for hanging

Cuchillas exclusivas de alto rendimiento  
Exclusive high performance blades

**Batidora BAMIX**

Mixer · Mixer  
Mixer · Bateadeira

Ref	€	U.Venta
61672	330,40	1
61673	516,10	1

Ref	Tensión/Voltage	Potencia/Power	Velocidad/Speed	Inmersión/Inmersion	Altura/Height
61672	220-240 V / 50-60 Hz	200 W	14.000 - 18.000 r.p.m.	25 cm	39,5 cm
61673	220-240 V / 50-60 Hz	350 W	18.000 - 22.000 r.p.m.	35 cm	49,5 cm

- Permite montar, batir, mezclar, triturar y picar todo tipo de frutas y verduras, así como picar hielo, gracias a sus cuchillas.
- Batidora de precisión y alta calidad.
- Permite trabajar con ella largo tiempo sin que se caliente.
- Mango diseñado para adaptarse a la mano.
- 2 posiciones:  
I : se utiliza con cantidades pequeñas, para preparados ligeros y esponjosos.  
II : se usa para cantidades más grandes e ingredientes viscosos y consistentes.
- Permet de monter, battre, mélanger, triturer et émincer tout type de fruits et légumes, ainsi que de piler la glace, grâce à ses lames.
- Mélangeur de précision de haute qualité.
- Vous permet de travailler avec lui pendant longtemps sans qu'il chauffe.
- Poignée conçue pour s'adapter à la main.
- 2 postes :  
I : utilisé en petites quantités, pour des préparations légères et moelleuses.  
II : utilisé pour de plus grandes quantités et des ingrédients visqueux et consistants.
- It enables assembly, beating, mixing, crushing, and chopping of all type of fruits, vegetables, and ice, thanks to its blades.
- High quality precision mixer.
- Allows you to work with it for a long time without it getting hot.
- Handle designed to fit the hand.
- 2 positions:  
I : used with small amounts, for light and fluffy preparations.  
II : used for larger quantities and viscous and consistent ingredients.

Accesorios · Accessoires · Accessories



**Cuchilla para carne**  
lame à viande · Klinge für Fleisch  
Blade for meat · Lâminar para carne

Ref	€	U.Venta
R61672D	20,20	1



**Grupo pulverizador**  
Broyeur · Mahleinheit  
Pulverizing unit · Conjunto pulverizador

Ref	€	ml	U.Venta
61674	47,30	250	1



**Grupo cortador**  
Combiné râpeur · Schneide-/Zubereitungseinheit  
Cutting/preparing unit · Conjunto cortador

Ref	€	ml	U.Venta
61675	194,20	500	1

5 Funciones  
Functions

# FAST Batidora

Household use



**Cuchillas exclusivas de alto rendimiento**  
Exclusive high performance blades

- Permite montar, batir, mezclar, triturar y picar todo tipo de frutas y verduras, así como picar hielo.
- Prepara salsas, batidos, papillas y cremas gracias a sus 4 cuchillas intercambiables (incluye llave para cambiar las cuchillas).
- 2 velocidades: SLOW/TURBO. Profundidad del brazo: 23 cm.
- Incluye un recipiente mezclador de 500, libre de BPA.

- Permet de monter, battre, mélanger, triturer et émincer tout type de fruits et légumes, ainsi que de piler la glace.
- Prépare des sauces, des smoothies, des bouillies et des crèmes grâce à ses 4 lames interchangeable (inclut une clé pour changer les lames).
- 2 vitesses : SLOW/TURBO. Profondeur du bras : 23 cm.
- Inclut un récipient pour mélanger de 500 ml, sans BPA.

- It enables assembly, beating, mixing, crushing, and chopping of all type of fruits, vegetables, and ice.
- Prepare sauces, smoothies, mashes, and creams with its 4 interchangeable blades (includes wrench to change blades).
- 2 speeds: SLOW/TURBO. Arm Depth: 23 cm.
- Includes a mixing container of 500 ml, BPA free.



## Batidora FAST

Mixeur · Mixer  
Blender · Batedeira

Ref	€	W	U.Venta
61681	74,90	700	1



**Cuchillas exclusivas de alto rendimiento**  
Exclusive high performance blades

## Batidora picadora FAST

Mixeur hacheur · Mixer und Fleischwolf  
Blender chopper · Batedeira picadora

Ref	€	W	U.Venta
61671	85,60	700	1



## Picadora

Hachoir · Fleischwolf  
Mincer · Picadora

Ref	€	ml	U.Venta
R61671A	12,30	750	1

Incluida en la Ref.: 61671 · Included in Ref.: 61671

# PREMIUM Batidora

Household use



**Resultados más finos y uniformes**  
Finer and more even blending



**Botón de bloqueo**  
Regulador de velocidad  
Lock button  
Speed regulator button

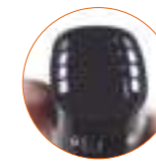

**Indicadores LED de velocidad**  
LED speed indicator light



**Superficie GRIP Technology**  
Surface with GRIP technology



**Fácil montaje**  
Easy assembly



**Antisalpicaduras**  
Anti-splash housing



**Cuchillas afiladas**  
Sharp blades

- PressSystem: ejerza más o menos presión sobre el botón de regulador de velocidad para aumentar o disminuir la velocidad y obtener la textura deseada.
- Pulsando el botón hasta el fondo el batidor funcionará a máxima velocidad.
- El nivel de velocidad se verá reflejado en el encendido de los indicadores LED.
- 4 cuchillas de acero inoxidable de máxima calidad: dos rectas y dos curvas para un rendimiento óptimo y profesional.
- Cierre bayoneta: fijación ultrarrápida y sencilla; bloquea y desbloquea el pie con un solo giro garantizando una fijación 100% segura.
- Fácil limpieza: vaso apto para el lavavajillas.
- Compacto y ergonómico: mango antideslizante.

- PressSystem: exercez une pression plus ou moins importante sur le bouton de régulation de vitesse pour augmenter ou réduire la vitesse et obtenir la texture souhaitée. En appuyant à fond sur le bouton, le mixeur fonctionnera à la vitesse maximale.
- Le niveau de vitesse se reflètera sur l'allumage des indicateurs lumineux.
- 4 lames en acier inoxydable de la plus grande qualité : deux droites et deux courbées pour un rendement optimal et professionnel.
- Fermeture à baïonnette : fixation ultra rapide et simple; bloque et débloque le pied d'une seule rotation et garantit une fixation 100% sûre.
- Facile à nettoyer : le bol passe au lave-vaisselle.
- Compact et ergonomique : manche antidérapant.

- PressSystem: Apply more or less pressure to the speed regulator button to increase or decrease the speed to get the texture you want. Press the button as far as it goes for maximum speed.
- The speed level is shown by the LED indicator.
- Four top quality stainless steel blades: two straight and two curved blades for optimum professional performance.
- Bayonet latch: the ultra-fast and easy attachment locks and unlocks the blending arm with a simple twist and guarantees a 100% secure hold.
- Easy to clean: the pitcher is dishwasher safe.
- Compact and ergonomic: non-slip handle.



## Batidora PREMIUM

Mixer · Mixer  
Mixer · Batedeira

Ref	€	W	U.Venta
61678	63,70	1000	1



## Batidor varillas

Fouet multibrins · Schneebeesen  
Wire whisk · Batedeira varetas

Ref	€	L (cm)	U.Venta
R61678L	5,60	23	1



## Picadora

Hachoir · Fleischwolf  
Mincer · Picadora

Ref	€	ml	U.Venta
R61678K	10,80	500	1

Ref	Tensión/Voltage	Potencia/Power	Velocidad/Speed	Capacidad/Capacity	Velocidad/Speed	L.brazo/Shaft leng	Peso/Weight
61681	220-240 V; 50/60 Hz	700 W	9.000 - 16.000 r.p.m.	500 ml (Glass)	SLOW / TURBO	23 cm	1,10 Kg
61671	220-240 V; 50/60 Hz	700 W	9.000 - 16.000 r.p.m.	750 ml (mincer) / 500 ml (Glass)	SLOW / TURBO	23 cm	1,45 Kg

Ref	Tensión/Voltage	Potencia/Power	Velocidad/Speed	Cap. contenedor/Container cap.	Dimensiones/Sizes	Peso/Weight
61678	220-240 V; 50/60 Hz	1000 W	16.000 r.p.m. (max)	800 ml (28 oz)	5,5x6,5x41 cm	0,960 Kg

# PRO Batidora

· Household use ·



**Resultados más finos y uniformes**  
Finer and more even blending



**Regulador de velocidad**  
Speed regulator

**TURBO Máxima potencia**  
Maximum power

**Fácil montaje / desmontaje**  
Easy assembly / disassembly



**Cuchillas afiladas**  
Sharp blades

**Antisalpicaduras**  
Anti-splash housing

**Mango ergonómico**  
Ergonomic handle

- **FUNCIÓN SELF-SPEED.** Permite regular la velocidad de giro de la cuchilla.
- **4 cuchillas de acero inoxidable de gran durabilidad:** dos rectas y dos curvas para un óptimo rendimiento.
- **Pie batidor de 21 cm de longitud y fabricado en acero inoxidable 18/10.**
- **El sistema de anclaje tipo rosca disminuye las vibraciones durante el uso.**
- **Incluye vaso mezclador con base antideslizante de 800 ml, marcado en ml/cups y libre de BPA.**
- **Accesorios aptos para el lavavajillas.**

- **FUNCTION SELF-SPEED.** Permet de régler la vitesse de rotation de la lame.
- **4 lames en acier inoxydable d'une grande durabilité :** deux droites et deux courbées pour un rendement optimal.
- **Pied mixeur de 21 cm de longueur fabriqué en acier inoxydable 18/10.**
- **Le système d'ancrage de type fileté réduit les vibrations pendant l'utilisation.**
- **Inclut un verre mélangeur avec une base antidérapante de 800 ml, avec des marques en ml/cups et sans bisphénol A.**
- **Accessoires aptes pour le lave-vaisselle.**

- **SELF-SPEED FUNCTION.** Enables you to control the speed at which the blade rotates.
- **4 highly durable stainless steel blades:** two straight and two curved for optimum performance.
- **21cm blending arm made of 18/10 stainless steel.**
- **The screw-type attachment system reduces vibrations during use.**
- **Includes 800ml BPA-free mixing beaker with anti-slip base, marked in ml/cups.**
- **Dishwasher-safe accessories.**



**Batidora PRO**  
Mixer · Mixer  
Mixer · Batedeira

Ref	€	W	U.Venta
A 61682	68,70	1000	1
B 61683	76,80	1000	1

**Picadora incluida**  
Mincer included



**Batidor varillas**  
Fouet multibrins · Schneebesen  
Wire whisk · Batedeira varetas

Ref	€	L (cm)	U.Venta
R61682B	7,30	20	1



**Picadora**  
Hachoir · Fleischwolf  
Mincer · Picadora

Ref	€	ml	U.Venta
R61682A	12,60	500	1

**Incluida en la Ref.: 61683**  
Included in Ref.: 61683

Ref	Tensión/Voltage	Potencia/Power	Velocidad/Speed	Vaso/Glass	Picadora/Mincer	Dimensiones/Sizes	Peso/Weight
61682	220-240 V; 50/60 Hz	1000 W	13.050 - 15.950 r.p.m.	800 ml (28 oz)	-	Ø6,3 x 41,2 cm	0,805 Kg
61683	220-240 V; 50/60 Hz	1000 W	13.050 - 15.950 r.p.m.	800 ml (28 oz)	500 ml	Ø6,3 x 41,2 cm	1,200 Kg

# MIX Batidora

· Household use ·



**Resultados más finos y uniformes**  
Finer and more even blending



**Regulador de velocidad**  
Speed regulator

**TURBO Máxima potencia**  
Maximum power

**Fácil montaje / desmontaje**  
Easy assembly / disassembly



**Cuchillas afiladas**  
Sharp blades

**Antisalpicaduras**  
Anti-splash housing

**SOFT TOUCH Mango ergonómico**  
Ergonomic handle

- **Dispone de una ruleta de fácil manejo para ajustar la velocidad y obtener la textura deseada.**
- **4 cuchillas de acero inoxidable de gran durabilidad:** dos rectas y dos curvas para un óptimo rendimiento. Sistema antisalpicaduras.
- **Pie batidor de 21 cm de acero inoxidable desmontable de fácil colocación que facilita su almacenamiento y limpieza.**
- **Incluye un recipiente mezclador de 800 ml (marcado en ml /oz), libre de BPA.**
- **Vaso apto para el lavavajillas.**

- **Dispose d'une roulette facile à utiliser pour ajuster la vitesse et obtenir la texture souhaitée.**
- **4 lames en acier inoxydable d'une grande durabilité :** deux droites et deux courbées pour un rendement optimal. Système anti-éclaboussures.
- **Pied mixeur de 21 cm en acier inoxydable démontable facile à installer qui facilite le rangement et le nettoyage.**
- **Inclut un récipient pour mélanger de 800 ml (avec marques en ml /oz), sans bisphénol A.**
- **Bol apte pour le lave-vaisselle.**

- **It has an easy-to-use wheel to adjust the speed and obtain the desired texture.**
- **4 highly durable stainless steel blades:** two straight and two curved for optimum performance. Anti-splash system.
- **The 21cm stainless steel blender stick is easy to attach and removable for easy storage and cleaning.**
- **Includes an 800ml BPA-free mixing bowl (marked in ml/oz).**
- **The glass is dishwasher safe.**



**Batidora MIX**  
Mixer · Mixer  
Mixer · Batedeira

Ref	€	W	U.Venta
61679	60,90	1200	1



**Batidor varillas**  
Fouet multibrins · Schneebesen  
Wire whisk · Batedeira varetas

Ref	€	L (cm)	U.Venta
R61679AB	6,80	23	1



**Picadora**  
Hachoir · Fleischwolf  
Mincer · Picadora

Ref	€	ml	U.Venta
R61679AA	12,10	800	1

Ref	Tensión/Voltage	Potencia/Power	Velocidad/Speed	Cap. contenedor/Container cap.	Dimensiones/Sizes	Peso/Weight
61679	220-240 V; 50/60 Hz	1200 W	13.000 - 15.300 r.p.m.	800 ml (28 oz)	Ø6,5 x 41 cm	0,930 Kg

# TitanPro Batidora

· Household use ·



**Resultados más finos y uniformes**  
Finer and more even blending



**Regulador de velocidad**  
Speed regulator

**TURBO**  
Máxima potencia  
Maximum power

**Fácil montaje / desmontaje**  
Easy assembly / disassembly



**Cuchillas afiladas**  
Sharp blades

**Antisplachaduras**  
Anti-splash housing



**Batidora TitanPro**  
Mixer · Mixer  
Mixer · Batedeira

Ref	€	W	U.Venta
A 61668	46,40	600	1
B 61669	59,20	600	1

**Picadora incluida**  
Mincer included

- **Velocidad variable:** dispone de un regulador de velocidad (1 - 5 velocidades) de fácil manejo para ajustar la velocidad y obtener la textura deseada.
- **Función TURBO:** máxima potencia para resultados rápidos, homogéneos e inmejorables.
- **4 cuchillas de acero inoxidable de máxima calidad:** dos rectas y dos curvas para un rendimiento óptimo y profesional.
- **Cierre bayoneta:** fijación ultrarrápida y sencilla; bloquea y desbloquea el pie con un solo giro garantizando una fijación 100% segura.
- **Fácil limpieza:** vaso apto para el lavavajillas.
- **Compacto y ergonómico:** mango antideslizante.

- **Vitesse variable :** dispose d'un régulateur de vitesse (1 - 5 vitesses) facile à utiliser pour régler la vitesse et obtenir la texture souhaitée.
- **Fonction TURBO :** puissance maximale pour des résultats rapides, homogènes et uniques.
- **4 lames en acier inoxydable de la plus grande qualité :** deux droites et deux courbées pour un rendement optimal et professionnel.
- **Fermeture à baïonnette :** fixation ultra rapide et simple; bloque et débloque le pied d'une seule rotation et garantit une fixation 100% sûre.
- **Facile à nettoyer :** le bol passe au lave-vaisselle.
- **Compact et ergonomique :** manche antidérapant.

- **Variable speed:** it has an easy to use speed regulator (1 - 5 speeds) for adjusting the speed to get the texture you want.
- **TURBO function:** maximum power for fast, homogeneous and unbeatable results.
- **Four top quality stainless steel blades:** two straight and two curved blades for optimum professional performance.
- **Bayonet latch:** the ultra-fast and easy attachment locks and unlocks the blending arm with a simple twist and guarantees a 100% secure hold.
- **Easy to clean:** the pitcher is dishwasher safe.
- **Compact and ergonomic:** non-slip handle.



**Batidor varillas**  
Fouet multibrins · Schneebesen  
Wire whisk · Batedeira varetas

Ref	€	L (cm)	U.Venta
R61668D	8,50	23,5	1



**Picadora**  
Hachoir · Fleischwolf  
Mincer · Picadora

Ref	€	ml	U.Venta
R61668C	17,00	500	1

**Incluida en la Ref.: 61669**  
Included in Ref. : 61669

Ref	Tensión/Voltage	Potencia/Power	Velocidad/Speed	Vaso/Glass	Picadora/Mincer	Dimensiones/Sizes	Peso/Weight
61668	220-240 V; 50/60 Hz	600 W	15.000 r.p.m.	600 ml	-	8,5 x6,28x39,7 cm	0,845 Kg
61669	220-240 V; 50/60 Hz	600 W	15.000 r.p.m.	600 ml	500 ml	8,5 x6,28x39,7 cm	1,085 Kg

# QUICK Picadora

· Professional use ·



**Picadora profesional QUICK**  
Hachoir professionnel · Professioneller Zerkleinerer  
Professional chopper · Picadora profesional

Ref	€	W	L	U.Venta
69490	980,80	735	3,0	1

- **Picadora profesional** que pica y tritura todo tipo de alimentos (verduras, hortalizas, carnes y frutos secos, etc.) de manera rápida y homogénea.
- **Contenedor extraíble** de acero inoxidable 18/10 de máxima calidad de 3 litros de capacidad.
- **Tapa de trítan transparente** totalmente extraíble con orificio para añadir ingredientes en marcha. Libre de BPA.
- **Cuchillas extraíbles** de acero inoxidable totalmente afiladas.
- **100% seguro:** evita la puesta en marcha si el contenedor o la tapa no están en la posición adecuada.
- **Dispone de protección** contra el sobrecalentamiento.
- **Encendido y apagado** con un solo clic mediante el botón ON / OFF.
- **Cubeta inclinada** para una fácil introducción y recogida de los alimentos.
- **Pies antideslizantes** para una máxima estabilidad.
- **Fácil limpieza.** Contenedor y tapa aptos para el lavavajillas.

- This professional chopper chops and crushes all kinds of food, like vegetables, greens, meat and nuts, quickly and evenly.
- It has a removable top quality 18/10 stainless steel container with a capacity of 3 litres.
- The transparent Tritan lid is completely removable and has a hole for adding ingredients while the chopper is running. It's BPA free.
- The removable stainless steel blades are completely sharpened.
- **100% Safe:** prevents starting if the lid or container are not in the right place.
- It has protection against overheating.
- It can be turned on and off with a single click using the ON / OFF button.
- The container is tilted so it's easy to put food in and take it out.
- It has non-slip feet for maximum stability.
- Easy to clean, the lid and container are dishwasher safe.

Ref	Tensión/Voltage	Potencia/Power	Velocidad/Speed	Cap. contenedor / Container cap.	Cuchillas (Ø) / Blades (Ø)	Orif. de entrada / Entry hole	Dimensiones/Sizes	Peso/Weight
69490	220-240 V ; 50/60 Hz	735 W	1500 r.p.m.	3,0 L	18,5 cm	5 cm	28,5x32x43 cm	14,20 Kg

# QUARTZ Picadora

· Household use ·



**2 velocidades**  
2 speeds

**Cierre seguro**  
Secure closure

**Cuchillas muy afiladas**  
Very sharp blades

**Gran capacidad**  
Great capacity

**Antideslizante**  
Anti-slip

**Picadora de cristal QUARTZ**  
Hachoir en verre · Fleischwolf, glas  
Glass mincer · Picadora de vidro

Ref	€	W	L	U.Venta
69077	45,40	300	1,2	1
69073	69,80	300	2,0	1

- **Picadora eléctrica compacta** que pica todo tipo de alimentos, como verduras, frutas, jengibre, ajo, cebolla, frutos secos y hierbas.
- **Cabezal de acero inoxidable** y recipiente de cristal de alta calidad.
- **Cuchillas ultrasresistentes.**
- **Gracias a los engranajes metálicos** permite un uso continuo.
- **Corta con precisión y homogéneamente.**
- **2 velocidades;** la más veloz para un corte rápido y la más lenta para un corte más controlado.
- **Base antideslizante** para facilitar la tarea y evitar desplazamientos.
- **Fácil de desmontar y limpiar.** Contenedor y cuchillas aptos para el lavavajillas.

- Compact electric mincer that processes all kinds of food, such as vegetables, fruit, ginger, garlic, onions, dried fruit and herbs.
- Stainless steel head and high-quality glass container.
- High-strength blades.
- Its metal gears mean it can withstand longer continuous use.
- High-precision, even cutting.
- 2 speeds: fast for rapid cutting and slow for more controlled cutting.
- Non-slip base for easier use with no movement.
- Easy to disassemble for cleaning Dishwasher-proof container and blades.

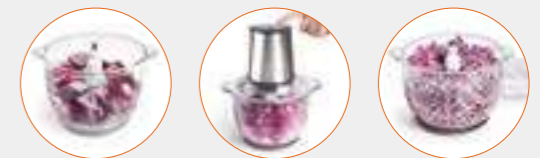

Ref	Tensión/Voltage	Potencia/Power	Nºcuchillas/Blades	Øcuchillas/Blades	Capacidad/Cap.	Dimensiones/Sizes	Peso/Weight
69077	220-240 V ; 50/60 Hz	300 W	4	10,5 cm	1,2 L	18,7x16x25 cm	1,60 Kg
69073	220-240 V ; 50/60 Hz	300 W	4	12,0 cm	2,0 L	21x17,5x27 cm	2,10 Kg

# PICADORAS CARNE

## Colección

· Semiprofessional use ·



ES

- Picadoras estables y resistentes.
- Engranajes interiores y exteriores metálicos para una mayor resistencia.
- Incluyen 3 discos perforados de acero inoxidable.
- Incluyen 4 accesorios extra (Kibbe incluido).
- Totalmente desmontables para facilitar su limpieza.

FR

- Hachoirs stables et résistants.
- Engrainages intérieurs et extérieurs métalliques pour une plus grande résistance.
- Inclut 3 disques perforés en acier inoxydable.
- Inclut 4 accessoires supplémentaires (kebbeh inclus).
- Totalemment démontable pour faciliter son nettoyage.

EN

- Stable and resistant choppers.
- Interior and exterior metal gear teeth for improved resistance.
- Includes 3 stainless steel perforated discs.
- Includes 4 extra accessories (Kibbe included).
- Can be fully disassembled for easy cleaning.



**3 discos perforados**  
3 stainless steel perforated discs



**Embutidos (salchichas, chorizo...)**  
Sausages (salchicha, chorizo...)



**Kibbe**  
kibbe

· Professional use ·

Productividad  
**2 kg/min**  
Productivity



### Picadora de carne PRO

Hachoir pour viande · Fleischwolf  
Meat mincer · Picadora de carne

Ref	€	W	U.Venta
69368	596,30	550	1

Productividad  
**1 kg/min**  
Productivity



### Picadora de carne STRONG

Hachoir pour viande · Fleischwolf  
Meat mincer · Picadora de carne

Ref	€	W	U.Venta
69068	234,00	800	1

Productividad  
**1 kg/min**  
Productivity



### Picadora de carne CHOP

Hachoir pour viande · Fleischwolf  
Meat mincer · Picadora de carne

Ref	€	W	U.Venta
69369	117,30	300	1

Ref	Tensión/Voltage	Potencia/Power	Par motor/Motor torque	Velocidad/Speed	Capacidad/Capacity	Dimensiones/Sizes	Peso/Weight
69368	220-240 V; 50 Hz	550 W	1,27 Nm	240 r.p.m	2 Kg/min	53,5x26x35 cm	11,0 Kg
69068	220-240 V; 50 Hz	800 W	0,25 Nm		1 Kg/min	35x18x36 cm	5,09 Kg
69369	220-240 V; 50/60 Hz	300 W	0,14 Nm		1 Kg/min	38,6x16,6x34,2 cm	3,70 Kg

# CORTADORAS FIAMBRE

## Colección



Professional use

- Cortadora eléctrica de alto rendimiento.
- Corta sin esfuerzo y con una gran precisión.
- Cuchilla desmontable de acero inoxidable de gran calidad.
- Regulador de grosor de corte entre 0 y 11/13 mm.
- Estructura de aluminio, transmisión por correa, pantalla protectora y cabezalajustable de suave deslizamiento.
- Cuenta con un alador extraíble para ayudar al mantenimiento de la cuchilla.

- Trancheuse électrique à haut rendement.
- Coupe sans efforts et avec une grande précision.
- Lame démontable en acier inoxydable de grande qualité.
- Régulateur d'épaisseur de découpe entre 0 et 11/13 mm.
- Structure en aluminium, transmission par courroie, paroi de protection et tête ajustable à glissement doux.
- Dispose d'un aiguiseur extractible pour aider à l'entretien de la lame.

- High performance electric cutter.
- Cuts effortlessly and with high precision.
- High quality removable stainless steel blade.
- Cut thickness regulator between 0 and 11/13 mm.
- Aluminium structure, belt driven, protective screen and adjustable smooth sliding head.
- It has a removable sharpener to help with blade maintenance.

Household use

- Cortafiambres eléctrico metálico con acabados en acero inoxidable.
- Cuchilla ultrarresistente y desmontable de acero inoxidable de Ø19 cm con puntas onduladas diseñada para cortar carne, embutido, queso, etc.
- Grosor de corte ajustable de 0 - 15 mm.
- Bandeja inoxidable abatible y de fácil limpieza.
- Pantalla protectora y cabezal ajustable de suave deslizamiento.
- Transmisión por engranaje.
- Muy estable: cuatro ventosas que evitan el deslizamiento en el uso.

- Electric metal meat slicer with a stainless steel finish.
- Ultra strong 19 cm diameter removable stainless steel blade with wavy teeth.
- Designed to cut meat, processed meats, cheese, etc.
- Adjustable cut from 0-15 mm. Easy to clean folding stainless steel tray.
- Protective screen and smooth sliding adjustable head.
- Geared transmission.
- Very stable: four suction cups that prevent sliding during use.

Transmisión por correa  
Belt drive



### Cortadora de fiambre PROFESIONAL

Trancheuse de charcuterie · Aufschnittmaschine  
Cold meat cutter · Cortadora de fiambre

Ref	€	W	U.Venta
69125	660,30	150	1
69130	1128,00	250	1

Ref	Tensión/Voltage	Potencia/Power	Cuchilla/Blade	Esp. corte/Slice thick.	Dimensiones/Sizes	Peso/Weight
69125	220-240 V; 50/60 Hz	150 W	Ø250 mm / 10"	0 - 11 mm	48x39x36 cm	15,0 Kg
69130	220-240 V; 50/60 Hz	250 W	Ø300 mm / 12"	0 - 13 mm	60x58x44 cm	24,3 Kg
69118	220-240 V; 50/60 Hz	150 W	Ø190 mm / 7 1/2"	0 - 15 mm	37,3x27,9x27,5 cm	4,51 Kg



**Bandeja inoxidable abatible**  
Stainless steel tray



**Transmisión por engranaje**  
Gear transmission



**Grosor de corte ajustable de 0 - 15 mm**  
Adjustable cut from 0-15 mm



### Cortadora de fiambre HOME

Trancheuse de charcuterie · Aufschnittmaschine  
Cold meat cutter · Cortadora de fiambre

Ref	€	W	U.Venta
69118	118,10	150	1

# PROFESIONAL

## Cortador de verduras

Professional use



ES

- Cortador de verduras para uso profesional.
- Construida totalmente en aluminio anodizado de alta resistencia.
- Cuerpo superior abatible para facilitar la limpieza, el mantenimiento y la colocación de los discos de corte.
- 2 entradas para los diferentes tipos de verduras; entrada semicircular con palanca para alimentos voluminosos (patatas, tomates, cebollas, etc.) y entrada redonda con empujador para verduras y hortalizas más pequeñas (pepinos, calabacín, zanahorias, etc.).
- Incluye 5 cuchillas: dos discos de corte (2 y 4 mm) y tres discos para rallar (3, 5 y 7 mm).
- Funcionamiento continuo. Transmisión por correa.
- 2 sistemas de seguridad: tornillo de bloqueo de tapa y un sensor electromagnético (al abrir la tapa se apaga la máquina).
- 4 patas de goma para una mejor estabilidad.

FR

- Coupe-légumes à usage professionnel.
- Entièrement fabriqué en aluminium anodisé d'une grande résistance.
- Corps supérieur rabattable pour faciliter le nettoyage, l'entretien et l'installation des disques de coupe.
- 2 entrées pour les différents types de légumes : entrée semi-circulaire avec levier pour aliments volumineux (pommes de terre, tomates, oignons, etc.) et entrée ronde avec poussoir pour légumes classiques et plus petits (concombres, courgettes, carottes, etc.).
- Inclut 5 lames : deux disques pour couper (2 et 4 mm) et trois disques pour râper (3, 5 et 7 mm).
- Fonctionnement continu. Transmission par courroie.
- 2 systèmes de sécurité : une vis de blocage du couvercle et un capteur électromagnétique (l'appareil s'arrête lors de l'ouverture du couvercle).
- 4 pieds en caoutchouc pour une meilleure stabilité.

EN

- Vegetable slicer for professional use.
- Manufactured entirely in high strength anodized aluminium.
- Removable upper body for easy cleaning, maintenance, and placement of slicing discs.
- 2 openings for different types of vegetables; semicircular opening with lever for larger foods (potatoes, tomatoes, onions, etc.) and round opening with pusher for smaller vegetables (cucumbers, zucchini, carrots, etc.).
- Includes 5 blades: two slicing discs (2 and 4 mm) and three grating discs (3, 5 and 7 mm).
- Continuous operation Belt drive.
- 2 safety systems: cover locking screw and an electromagnetic sensor (when the cover is opened the machine turns off).
- 4 rubber bases for improved stability.



**2 entradas para los diferentes tipos de verduras**  
2 openings for different types of vegetables

Producción  
100-300 kg/h  
Production



### Cortadora de vegetales PROFESIONAL

Coupe-légumes · Gemüseschneider  
Vegetable slicer · Cortadora de verduras

Ref	€	W	U.Venta
69500	1386,30	550	1

Ref	Tensión/Voltage	Potencia/Power	Nºdiscos/Discs	Veloc. discos Discs speed	Orif. redondo Round hole size	Orif. semicircular Semicircular hole	Dimensiones/Sizes	Peso/Weight
69500	220-240 V ; 50 Hz	550 W	5	270 r.p.m.	Ø 6 cm	17x7,5 cm	57x23x51 cm	22,5 Kg

Accesorios · Accessoires · Accessories



#### Disco rallador

Disque à râper · Reibe Scheibe  
Grater disc · Disco de ralador

	Ref	€	mm	U.Venta
A	69503	46,20	3	1
B	69505	46,20	5	1
C	69507	46,20	7	1

#### Disco cortador

Disque de coupe · Schneidscheibe  
Cutter disc · Disco de corte

	Ref	€	mm	U.Venta
A	69512	46,20	2	1
B	69514	46,20	4	1

Discos opcionales (NO incluidos) · Disques en option (NON inclus) · Optional diss (NOT included)

#### Disco cortador

Disque de coupe · Schneidscheibe  
Cutter disc · Disco de corte

	Ref	€	mm	U.Venta
A	69518	92,20	8	1
B	69510	92,20	10	1
C	69504	107,10	10	1
D	69506	125,30	10x10	1



# KEBAB

## Cortador

Professional use



Incluye dos cuchillas LISA y DENTADA y destornillador para desmontar la cuchilla y una práctica piedra afiladora  
Includes two blades SMOOTH and SERRATED and screwdriver for removing the blade and a practical sharpening stone included



### Cortador de kebab

Couteau à kebab · Kebab-Schneider  
Kebab cutter · Cortador de kebab

Ref	€	W	U.Venta
69230	194,80	80	1

Ref	Tensión/Voltage	Potencia/Power	Velocidad/Speed	Cuchilla/Blade	Esp. corte/Thickness	Dimensiones/Sizes	Peso/Weight
69230	220-240 V; 50/60 Hz	80 W	2.800 r.p.m.	Ø100 mm	0 - 8 mm	19,9x11,4x18,4 cm	1,20 Kg

- Potente, silencioso e higiénico.
- Cuchilla desmontable de acero inoxidable de gran calidad.
- Corta sin esfuerzo y con una gran precisión.
- Regulador del grosor de corte (Ajustable de 0 a 8 mm).
- Mango ergonómico, se adapta perfectamente a la mano.
- Incluye un destornillador para desmontar la cuchilla y una práctica piedra afiladora.

- Puissant, silencieux et hygiénique.
- Lame démontable en acier inoxydable de grande qualité.
- Coupe sans efforts et avec une grande précision.
- Régulateur de l'épaisseur de découpe (réglable de 0 à 8 mm).
- Manche ergonomique, qui s'adapte parfaitement à la main.
- Inclut un tournevis pour démonter la lame et une pratique pierre à aiguiser.

- Powerful, quiet and clean.
- High quality stainless steel removable blade.
- Effortless and high precision cutting.
- Adjustable slicing thickness (from 0 to 8 mm).
- Ergonomic handle fits your hand perfectly.
- Screwdriver for removing the blade and a practical sharpening stone included.

Regulador del grosor de corte (ajustable de 0 a 8 mm)  
Adjustable slicing thickness (from 0 to 8 mm)

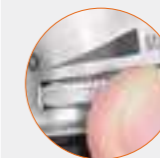

# ALIMENTOS

## Procesador

Household use



ES

- Múltiples funciones; pica, ralla, mezcla, bate, monta y tritura.
- Rendimiento óptimo y profesional: resultados rápidos, homogéneos e inmejorables.
- Gran capacidad; recipiente transparente graduado y jarra batidora transparentegrada.
- Infinidad de posibilidades: gracias a sus accesorios de alto rendimiento podrás cocinar sin esfuerzo.
- Tapa y bol con sistema de anclaje de seguridad.
- Diseño atractivo, compacto y muy cómodo para guardar: los accesorios pueden guardarse en el mismo recipiente.
- Fácil de limpiar. Accesorios aptos para el lavavajillas.

FR

- Multifonctions : hache, râpe, malaxe, bat, fouette et triture.
- Des performances optimales et professionnelles : résultats rapides, homogènes et imbattables.
- Une grande capacité : récipient transparent gradué et bol mixeur transparent gradué.
- Des possibilités infinies : grâce à accessoires performants, vous pourrez cuisiner sans effort tout ce que vous voulez.
- Couvercle et bol avec système d'ancrage de sécurité.
- Design attrayant, compact et très pratique à ranger : les accessoires peuvent être stockés dans le même récipient.
- Facile à nettoyer. Accessoires lavables au lave-vaisselle.

EN

- Multiple functions: It minces, grates, mixes, blends, whips and grinds.
- Optimum and professional performance: fast, homogeneous and unbeatable results.
- High capacity: graduated transparent container and a graduated transparent blender pitcher.
- Limitless possibilities: thanks to high performance accessories you can cook anything you wish effortlessly.
- The lid and bowl have a safety latch system.
- The attractive, compact and very comfortable design lets you keep the accessories right in the container.
- Easy to clean: the accessories are dishwasher safe.



Corte con cuchilla  
Cutting with blades

Exprimidor  
Citrus press

Conjunto Cuchillas  
Mezclador-amasa-  
dor Batidor  
Set Blades  
Mixer-kneader · Whisk

Jarra batidora  
Blender jug



8  
Accesorios  
Accessories

### Procesador de alimentos multiGenius

Robot multifonction · Küchenmaschine  
Food processor · Processador de alimentos

Ref	€	W	U.Venta
69579	132,00	800	1

Ref	Tensión/Voltage	Potencia/Power	Velocidades/Speeds	Capacidad/Capacity	Dimensiones jarra Jar sizes	Dimensiones jarra bat. Blender jar sizes	Peso jarra Jar weight	Peso jarra bat. Blender jar weight	Peso Weight
69579	220-240 V; 50/60 Hz	800 W	2 + PULSE	2,0 L - Jarra 1,5 L - Batidor 30 ml - Vaso medidor	26x24x42,5 cm	23x24x43,5 cm	2,70 Kg	2,47 Kg	3,80 Kg



Jarra batidora  
Blender jug

Conjunto batidor/montador  
Blending/whipping unit

Molinillo + Tapa  
Grinder + Lid

Discos corte  
Cutting discs

Conj. exprimidor  
Juicer attachment

Cortador mini  
Mini cutter

Conj. licuadora  
Smoothie unit

Corte con cuchilla  
Cutting with blades



8  
Funciones  
Functions

### Robot multifunción

Robot multifonctions · Multifunktions-Roboter  
Multifunction robot · Robò multifuncionais

Ref	€	W	U.Venta
69079	184,30	800	1

Ref	Tensión/Voltage	Potencia/Power	Velocidades/Speeds	Capacidad/Capacity	Dimensiones/Sizes	Peso/Weight
69079	220-240 V; 50 Hz	800 W	10	1,50 L	24x22x40 cm	6,50 Kg



2 en 1

Accesorio para helado de frutas  
Fruit ice cream accessory

5 cuchillas de colores  
5 colored blades



### Corta vegetales + máquina de helado COSMO

Hachoir légumes + machine à fruitcreme glacee · Gemüseschneider + Obst-Eis machine  
Vegetables cutter + ice fruit machine · Corta vegetables + máq. de gelado de fruta

Ref	€	W	U.Venta
69115	80,30	150	1

Ref	Tensión/Voltage	Potencia/Power	Cuchillas/Blades	Dimensiones/Sizes	Peso/Weight
69115	220-240 V; 50/60 Hz	150 W	6	24,5x22,5x19,5 cm	1,89 Kg



- Versátil: Procesador eléctrico de verduras con accesorio para hacer helado.
- Incluye 6 cuchillas de corte (en formato cono) de acero inoxidable de máxima calidad para todo tipo de cortes; verdura, fruta, queso, frutos secos, chocolate, etc.
- Incluye un accesorio diseñado para hacer helados y sorbetes con fruta congelada.
- Rápido, intuitivo y muy fácil de usar.
- Compacto: Práctico para usar y guardar; las cuchillas se almacenan en el interior.
- 100% seguro: no hay contacto directo con las manos.
- Funcionamiento silencioso.
- Fácil de limpiar: accesorios aptos para el lavavajillas.
- 100% Libre de BPA.

- Fully versatile: electric vegetable cutter with an ice cream attachment.
- Includes 6 top quality stainless steel, cone-type cutting blades for all kinds of cuts; suitable for vegetables, fruit, cheese, nuts, chocolate, etc.
- Comes with an attachment to make ice cream and sorbets from frozen fruit.
- Very practical, quick and easy to use.
- Compact: convenient to use and store; blades neatly stored inside.
- 100% safe: no direct contact with hands.
- Silent operation.
- Easy to clean: dishwasher safe accessories.
- 100% BPA free

Click here





# DESHIDRATADORES

## Colección

Professional use



ES

- Una forma natural y sencilla de conservar frutas, verduras, setas, carnes, pescados, etc. con todos sus nutrientes durante más tiempo.
- Extrae el agua, impidiendo su descomposición por microorganismos, conservándolos sin perder sus valores.
- Calentamiento, el aire circula por su interior de manera uniforme, penetrando por los orificios de las bandejas.
- Accesorio adicional para deshidratar salsas y realizar galletas.

FR

- Une façon naturelle et simple de conserver les fruits, les légumes, les champignons, les viandes, les poissons, etc. en gardant tous leurs nutriments pendant plus longtemps.
- Extrait l'eau, empêchant ainsi leur décomposition due à des microorganismes, en les conservant sans perdre leurs valeurs.
- Chauffe, l'air circule uniformément, en pénétrant par les orifices des plateaux.
- Accessoire supplémentaire pour déshydrater des sauces et réaliser des biscuits.

EN

- A natural and easy way to preserve fruits, vegetables, mushrooms, meats, fish, etc. with all their nutrients for more time.
- Extracts water from foods, preventing spoilage due to microorganisms and preserving them without losing their values.
- Heating, the air circulates evenly through its interior, penetrating through the holes in the trays.
- Additional accessory for dehydrating sauces and making biscuits.



Tiempo recomendado 35 h (max) Recommended time

6 Bandejas Trays

### Deshidratador de alimentos PRO

Deshydrateur des aliments · Obstrockner, elektrisch  
Food dehydrator · Desidratador de alimentos

Ref	€	W	U.Venta
69523	203,90	800	1

Ref	Tensión/Voltage	Potencia/Power	Temperatura/Temp.	Capacidad/Capacity	Dimensiones/Sizes	Peso/Weight
69523	220-240 V; 50/60 Hz	800 W	29°C - 73°C (máx)	6 bandejas / Trays	36x47x26 cm	5,50 Kg

Accesorio · Accessoire · Accessory



3 pcs

Fácil de cortar  
Easy to cut

Apto para todas las freidoras de aire · Suitable for all air fryers

### Láminas antiadherentes

Feuilles antiadhésif · Antihaf-Bblätter  
Non-stick sheets · Láminas antiaderentes

Ref	€	cm	unidades	U.Venta
66746	9,80	30x40	3	1



- Láminas de fibra de vidrio con recubrimiento antiadherente de gran calidad.
- Ideal para colocar sobre bandejas o parrillas de hornos y deshidratadores.
- Vida útil aproximadamente de 1000 horneados.
- Diseñadas para soportar temperaturas de hasta 250°C.
- Recortable para adaptar a cualquier recipiente.
- Reutilizables, para una correcta conservación se recomienda su lavado a mano.
- No aptas para el lavavajillas.

- Fiberglass sheets with non-stick coating high-quality.
- Ideal for placing on baking trays, oven racks and dehydrators.
- Can be used approximately 1,000 times.
- Designed to withstand temperatures up to 250°C.
- Can be cut to fit any container.
- Reusable; in order to keep the sheets in good condition, we recommend washing by hand.
- Non-dishwasher safe.

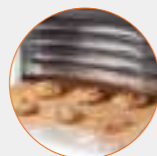

Semiprofessional use



5 Bandejas Trays  
Tiempo recomendado 48 h (max) Recommended time



### Deshidratador giratorio TERRA

Déshydrateur tournant · Drehdehydrator  
Rotating dehydrator · Desidratador giratório

Ref	€	W	U.Venta
69223	129,50	500	1

Household use

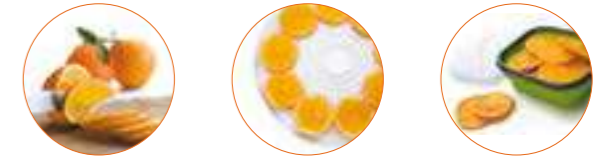

5 Bandejas Trays  
Tiempo recomendado 35 h (max) Recommended time



### Deshidratador de alimentos WHITE

Deshydrateur des aliments · Obstrockner, elektrisch  
Food dehydrator · Desidratador de alimentos

Ref	€	W	U.Venta
69123	76,30	250	1

Ref	Tensión/Voltage	Potencia/Power	Temperatura/Temp.	Capacidad/Capacity	Dimensiones/Sizes	Peso/Weight
69223	220-240 V; 50/60 Hz	500 W	70°C (max)	5 bandejas / Trays	Ø33x22 cm	2,80 Kg
69123	220-240 V; 50/60 Hz	250 W	70°C (max)	5 bandejas / Trays (13,5 L)	Ø32x27 cm	2,45 Kg

# ECCO

## Cocedor de vapor

Household use



Numeración en bandejas  
Cubeta para cocinar arroz  
Numbering in trays  
Container for cooking rice

Mantiene todos los  
nutrientes, aromas y  
sabores de los alimentos  
Retains all the nutrients,  
aromas and flavours of food

### Cocedor al vapor ECCO

Cuiseur vapeur · Dampfkochgerät  
Steam cooker · Panela de cocção a vapor

Ref	€	W	U.Venta
69121	92,00	1000	1

Ref	Tensión/Voltage	Potencia/Power	Temperatura/Temp.	Capacidad/Capacity	Dimensiones/Sizes	Peso/Weight
69121	220-240 V; 50-60 Hz	1000 W	100°C (máx)	12 L	41x35x26,57 cm	3,16 Kg



# INDUCCIÓN

## Freidora

Professional use

Inox CE

ES

- Ideal para un uso intensivo en la hostelería y cocinas con grandes cargas de trabajo.
- Potente y eficiente. Capacidad de 8 L.
- Construida totalmente en acero inoxidable (exterior e interior) que garantiza durabilidad y resistencia.
- Gracias al sistema de calentamiento por inducción se consigue una temperatura estable en todo el área, disminuyendo el impacto térmico en el momento de introducir los alimentos.
- Control de temperatura variable de 60°C a 190°C.
- Protección contra el sobrecalentamiento.
- Equipada con grifo de vaciado y elemento de calentamiento oculto para facilitar la limpieza.
- Tapa y cesta incluidas.

FR

- Idéale pour un usage intensif dans l'hôtellerie et dans des cuisines avec de grandes charges de travail.
- Puissante et efficace. Capacité de 8 L.
- Entièrement fabriquée en acier inoxydable (extérieur et intérieur), ce qui garantit durabilité et résistance.
- Le système de chauffe par induction permet d'obtenir une température stable dans tout l'espace, réduisant ainsi l'impact thermique lors de l'introduction des aliments.
- Contrôle de température variable de 60°C à 190°C.
- Protection contre la surchauffe.
- Équipée d'un robinet de vidange et d'un élément de chauffe caché pour faciliter le nettoyage.
- Couvercle et panier inclus.

EN

- Perfect for heavy use in hotels and restaurants and kitchens with big work loads.
- Powerful and efficient 8 L Capacity.
- Made entirely of stainless steel (inside and outside), which guarantees strength and durability.
- Because of the induction heating system there is a stable temperature in the whole area, which reduces thermal impact when putting the food inside.
- Variable temperature control from 60°C to 190°C.
- Protection against overheating.
- It has a drain tap and a hidden heating element for easy cleaning.
- Lid and basket included.

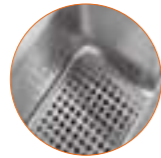

Rejilla  
Rack



Cerrado  
Closed



Abierto  
Open



### Freidora de inducción

Friteuse à induction · Induktionsfriteuse  
Induction fryer · Fritadeira de indução

Ref	€	W	L	U.Venta
69465	537,40	3500	8	1

Ref	Tensión/Voltage	Potencia/Power	Rango temperatura/ Temperature range	Cestillo/Basket	Cap. cestillo/Basket cap.	Tanque aceite/oil tank	Cap. tanque aceite/Oil tank capacity	Dimensiones/Sizes	Peso/Weight
69465	220-240 V; 50 Hz	3500 W	60°C - 190°C	19x23x14,5 cm	5,5 L	23,8x30x20,5 cm	8 L	29x56,7x41,5 cm	12,6 Kg

# PROFESIONAL

## Freidora

Inox CE

ES

- Destinada a un uso intensivo en restaurantes, bares, hoteles, etc.
- Especial para todo tipo de frituras, permite freír gran cantidad de alimento.
- Fabricada en acero inoxidable, exterior e interior, garantiza una gran durabilidad y resistencia.
- Termostato de temperatura regulable.
- Termostato de seguridad con rearme manual.
- Mango termorresistente.
- Sistema de fijación de la cesta para escurrir el aceite.
- Indicador máximo-mínimo de nivel de aceite.
- Panel extraíble para facilitar el mantenimiento y la limpieza.

FR

- Destinée à un usage intensif dans les restaurants, les bars, les hôtels, etc.
- Spécial pour tout type de friture, permet de frire de grandes quantités d'aliments.
- Fabriquée en acier inoxydable, extérieur et intérieur, elle garantit une grande durabilité et résistance.
- Thermostat de température réglable.
- Thermostat de sécurité avec réinitialisation manuelle.
- Manche résistant à chaleur.
- Système de fixation du panier pour égoutter l'huile.
- Indicateur maximum-minimum du niveau d'huile.
- Panneau extractible pour faciliter l'entretien et le nettoyage.

EN

- Intended for heavy-duty use in restaurants, bars, hotels, etc.
- Essential for all types of fried dishes, it can fry a large amount of food.
- Made of stainless steel, exterior and interior, guarantees great durability and resistance.
- Adjustable temperature thermostat.
- Safety thermostat with manual reset.
- Heat resistant handle.
- System for hanging the basket to drain the oil.
- Minimum-maximum oil level indicator.
- Removable panel for easy maintenance and cleaning.



Resistencia  
Resistance



Cerrado  
Closed



Abierto  
Open



### Freidora

Friteuse · Friteuse  
Fryer · Fritadeira

Ref	€	W	L	U.Venta
69169	272,40	2500	6,0	1
69466	426,30	2500x2	6,0x2	1

Simple · Simple  
Doble · Double

### Freidora con grifo

Friteuse avec robinet · Friteuse mit Wasserhahn  
Fryer with tap · Fritadeira com torneira

Ref	€	W	L	U.Venta
69468	288,90	3250	8,0	1
69469	550,80	3250x2	8,0x2	1

Simple · Simple  
Doble · Double

Ref	Tensión/Voltage	Potencia/Power	Temperat./Temp.	Capac./Capacity	Cont./Container	Cestillo/Basket	Dimensiones/Sizes	Peso/Weight
69169	220-240 V; 50/60 Hz	2500 W	50°C - 190°C	6,0 L	32,5 x26,5x15 cm	24x20x10,5 cm	27x41x31 cm	5,50 Kg
69466	220-240 V; 50/60 Hz	2500 W x 2	50°C - 190°C	6,0 L x 2	32,5 x26,5x15 cm	24x20x10,5 cm	55x41x31 cm	10,0 Kg
69468	220-240 V; 50/60 Hz	3250 W	50°C - 190°C	8,0 L	24x30x20 cm	18,5x24x14 cm	27x41x42 cm	7,00 Kg
69469	220-240 V; 50/60 Hz	3250 W x 2	50°C - 190°C	8,0 L x 2	24x30x20 cm	18,5x24x14 cm	55x41x42 cm	14,0 Kg

# ERGO

## Freidora

· Semiprofessional use ·



ES

- Especial para todo tipo de frituras, permite freír gran cantidad de alimentos.
- Termostato de temperatura regulable.
- Termostato de seguridad con rearme manual.
- Mango termorresistente.
- Sistema de fijación de la cesta para escurrir el aceite.
- Indicador máximo-mínimo de nivel de aceite.
- Las paredes exteriores se mantendrán frías en todo momento.

FR

- Spécial pour tout type de friture, permet de frire de grandes quantités d'aliments.
- Thermostat de température réglable.
- Thermostat de sécurité avec réinitialisation manuelle.
- Manche résistant à chaleur.
- Système de fixation du panier pour égoutter l'huile.
- Indicateur maximum-minimum du niveau d'huile.
- Les parois extérieures restent toujours froides.

EN

- Essential for all types of fried dishes, it can fry a large amount of food.
- Adjustable temperature thermostat.
- Safety thermostat with manual reset.
- Heat resistant handle.
- System for hanging the basket to drain the oil.
- Minimum-maximum oil level indicator.
- The external walls will be kept cool at all times.

Fabricada en acero inoxidable, garantiza una gran durabilidad y resistencia  
Made of stainless steel, guarantees great durability and resistance



Ventana en la tapa  
Cubeta extraíble  
Cabezal desmontable  
Window in the lid  
Removable tray  
Detachable head



### Freidora

Friteusem · Friteuse  
Fryer · Fritadeira

Ref	€	W	L	U.Venta
69135	113,20	2000	3,50	1 Simple · Simple
69170	226,80	2000x2	3,50x2	1 Doble · Double

### Freidora con grifo

Friteuse avec robinet · Friteuse mit Abflabahn  
Fryer with tap · Fritadeira com torneira

Ref	€	W	L	U.Venta
69134	196,00	2500	4,0	1

Ref	Tensión/Voltage	Potencia/Power	Temperatura/Temp.	Capacidad/Capacity	Dimensiones/Sizes	Peso/Weight
69135	220-240 V; 50/60 Hz	2000 W	190°C	3,50 L	41x22x21 cm	2,70 Kg
69170	220-240 V; 50/60 Hz	4000 W	190°C	3,50 x 2 L	41x39,5x21 cm	6,60 Kg
69134	220-240 V; 50/60 Hz	2500 W	190°C	4,00 L	44,3x24,7x27,5 cm	2,94 Kg

# dAirePro

## Freidora de aire

· Household use ·



ES

- **RapidAir Technology: la tecnología de ventilación de aire caliente circula a máxima velocidad y a 360° dentro de la cámara de cocción.**
- **Máxima versatilidad "9 en 1"**
- **Control de tiempo (hasta 60 minutos y 6 horas para deshidratar) y ajuste de temperatura de cocción de forma precisa (de 40°C a 200°C).**
- **Gran potencia 1700W y máxima capacidad: 12 litros.**
- **7 accesorios incluidos: 3 rejillas, bandeja, cestillo redondo, pincho mariposa y asa para cestillo redondo.**

FR

- **RapidAir Technology : La technologie de ventilation à air chaud circule à une vitesse maximum et à 360° dans la chambre de cuisson.**
- **Versatilité maximum « 9 en 1 »**
- **Contrôle de temps (jusqu'à 60 minutes et 6 heures pour déshydrater) et réglage de la température de cuisson de façon précise (de 40°C à 200°C).**
- **Grande puissance de 1700W et capacité maximale de 12 litres.**
- **7 accessoires inclus : 3 grilles, plateau, panier rond, tournebroche et poignée pour panier rond.**

EN

- **RapidAir Technology: the air ventilation technology circulates hot 360°C air at maximum speed inside the cooking chamber**
- **Maximum "9-in-1" versatility**
- **Time control (up to 60 minutes and 6 hours for dehydration) and precise cooking temperature settings (from 40°C to 200°C).**
- **High power: 1700W. Maximum capacity: 12 litres.**
- **7 accessories included: 3 racks, tray, round basket, skewer with clamps and handle for round basket.**

### Freidora de aire dAirePro

Friteuse airfryer · Aidfryer Heißluft-Fritteuse  
Air fryer · Fritadeira de aire

Ref	€	W	L	U.Venta
69513	187,50	1700	12	1



7 accesorios incluidos  
7 accessories included:

Ref	Tensión/Voltage	Potencia Power	Temp. Temp.	Temporizador Timer	Programas Programmes	Capacidad Capacity	Medidas internas Internes sizes	Dimensiones Sizes	Peso Weight
69513	220-240 V; 50/60 Hz	1700 W	40°C - 200°C	1 - 60 min	9	12 L	25x22x17,5 cm	32,3x35,8x37,8 cm	8,50 Kg

# DUPLOAIR

## Freidora de aire

· Household use ·



ES

- 11 programas automáticos preestablecidos
- **Gran capacidad: 9 L (dos cestillos extraíbles de 4,0 L de capacidad cada uno).**
- **Cestillo doble: control de tiempo y temperatura independiente.**
- **SyncFinish: acabado sincronizado.**
- **Temperatura regulable: gracias a su termostato podrás regular la temperatura desde 45°C a 200°C. Tiempo ajustable: 0-60 minutos (función deshidratada hasta 20 horas).**
- **Potencia: 2400 W.**

FR

- 11 programmes automatiques préétablis.
- Grande capacité : 9L (Deux paniers amovibles d'une capacité de 4,0 L chacun).
- Panier double : contrôle du temps et de la température de façon indépendante.
- SyncFinish : fin synchronisée.
- Température réglable : Grâce à son thermostat, la température peut être réglée de 45°C à 200°C.
- Durée réglable de 0 à 60 minutes (fonction déshydratation jusqu'à 20 heures).
- Puissance : 2400 W.

EN

- 11 pre-set automatic programmes.
- High capacity: 9 L (two removable 4.0 L capacity baskets each).
- Double basket: independent time and temperature control.
- SyncFinish: synchronised finish.
- Adjustable temperature: the thermostat allows you to set the temperature from 45°C to 200°C.
- Programmable time: 0-60 minutes (dehydration function up to 20 hours).
- Power: 2400 W.

**Tecnología TotalCook: distribuye el calor de manera uniforme a través del aire caliente a gran velocidad**

TotalCook Technology: it distributes heat uniformly with high speed hot air.

**Incluye rejillas**  
Includes grids

### Freidora de aire DUPLOAIR

Friteuse airfryer · Aidfryer Heißluft-Fritteuse  
Air fryer · Fritedeira de aire

Ref	€	W	U.Venta
69508	212,60	2400	1

Ref	Tensión/Voltage	Potencia Power	Temp. Temp.	Temporizador Timer	Programas Programs	Capacidad cestillo Basket capacity	Medidas cestillo Basket sizes	Dimensiones Sizes	Peso Weight
69508	220-240 V; 50/60 Hz	2400 W	45°C - 200°C	1 - 60 min	11	4,0 L (x2)	14,5x21x12,5 cm	41x33,5x31,5 cm	7,50 Kg

# CrystalFry

## Freidora de aire



New

ES

- 8 programas automáticos preestablecidos
- **Tecnología TotalCook: distribuye el calor de manera uniforme a través del aire caliente a gran velocidad.**
- **Gran capacidad: 7,0 litros.**
- **Intuitiva y muy fácil de usar: gracias a la pantalla digital se puede ajustar el tiempo (hasta 60 minutos), la temperatura (de 40°C a 200°C.) y los 8 programas preestablecidos.**
- **TotalControl: controla el cocinado gracias a la puerta de cristal y la luz interior.**
- **Cestillo extraíble con antiadherente 100% libre de PFOA. Libre de BPA.**

FR

- 8 programmes automatiques préétablis.
- Technologie TotalCook : distribue la chaleur de manière homogène à travers l'air chaud à grande vitesse.
- Grande capacité : 7,0 litres.
- Intuitif et très facile à utiliser : grâce à l'affichage numérique, vous pouvez régler le temps (jusqu'à 60 minutes), la température (de 40°C à 200°C) et les 8 programmes prédéfinis.
- TotalControl : contrôle le processus de cuisson grâce à la porte en verre et à l'éclairage intérieur.
- Panier amovible avec revêtement antiadhésif sans PFOA. Sans BPA.

EN

- It has 8 pre-set automatic programmes
- TotalCook Technology: It distributes heat uniformly with high speed hot air.
- High capacity: 7,0 litres.
- Intuitive and very easy to use: Thanks to the digital screen, you can set the time (up to 60 minutes), temperature (from 40°C to 200°C) and use 8 pre-set programmes.
- TotalControl: controls the cooking process thanks to glass door and interior light.
- The removable non-stick basket is 100% PFOA free. BPA free.

**Tecnología TotalCook: distribuye el calor de manera uniforme a través del aire caliente a gran velocidad**

TotalCook Technology: it distributes heat uniformly with high speed hot air.

**TotalControl: controla el cocinado gracias a la puerta de cristal y la luz interior**

TotalControl: control the cooking process thanks to glass door and interior light

**Incluye rejillas**  
Includes grids

### Freidora de aire CrystalFry

Friteuse airfryer · Aidfryer Heißluft-Fritteuse  
Air fryer · Fritedeira de aire

Ref	€	W	L	U.Venta
69515	126,90	1700	7,0	1

Ref	Tensión/Voltage	Potencia Power	Temp. Temp.	Temporizador Timer	Capacidad cubeta Container capacity	Medidas cestillo Basket sizes	Dimensiones Sizes	Peso Weight
69515	220-240 V; 50/60 Hz	1700 W	40°C - 200°C	1 - 60 min	7,0 L	28x24x13 cm	40,9x29,6x34,2 cm	5,07 Kg

# ECOFRY

## Freidora de aire

Inox CE   **Incluye RECETARIO**  
 RECIPES BOOK included



ES

- 8 programas automáticos preestablecidos
- **Tecnología TotalCook: distribuye el calor de manera uniforme a través del aire caliente a gran velocidad.**
- **Gran capacidad: 5,5 litros (cestillo).**
- **Intuitiva y muy fácil de usar: gracias a la pantalla digital se puede ajustar el tiempo (hasta 60 minutos), la temperatura (de 40°C a 200°C.) y los 8 programas preestablecidos.**
- **Recipiente/Cestillo extraíble con antiadherente 100% libre de PFOA.**

FR

- 8 programmes automatiques pré-régulés
- Technologie TotalCook : distribue la chaleur de manière homogène à travers l'air chaud à grande vitesse.
- Grande capacité : 5,5 litres (panier).
- Intuitif et très facile à utiliser : grâce à l'affichage numérique, vous pouvez régler le temps (jusqu'à 60 minutes), la température (de 40°C à 200°C) et les 8 programmes prédéfinis.
- Récipient/panier amovible avec revêtement antiadhésif sans PFOA.

EN

- It has 8 pre-set automatic programmes
- TotalCook Technology: it distributes heat uniformly with high speed hot air.
- High capacity: 5.5 litres (basket).
- Intuitive and very easy to use: thanks to the digital screen, you can set the time (up to 60 minutes), temperature (from 40°C to 200°C) and use 8 pre-set programmes.
- The removable non-stick basket/container is 100% PFOA free.



**Tecnología TotalCook: distribuye el calor de manera uniforme a través del aire caliente a gran velocidad**  
 TotalCook Technology: it distributes heat uniformly with high speed hot air.

**Incluye rejillas**  
 Includes grids



### Freidora de aire ECOFRY

Friteuse airfryer · Aidfryer Heißluft-Fritteuse  
 Air fryer · Friteadeira de aire

Ref	€	W	U.Venta
69511	171,00	1700	1

Ref	Tensión/Voltage	Potencia Power	Temp. Temp.	Temporizador Timer	Programas Programmes	Cap./medidas cestillo Basket cap./Sizes	Cap./Medidas cubeta Container cap./Sizes	Dimensiones Sizes	Peso Weight
69511	220-240 V; 50/60 Hz	1700 W	40°C - 200°C	1 - 60 min	8	5,5 L (24x21,5x11,5 cm)	6,5 L (26x23,8x13 cm)	41x30x34,5 cm	5,40 Kg

# VITALCOOK

## Freidora de aire

CE   **Incluye RECETARIO**  
 RECIPES BOOK included



ES

- **Tecnología TotalCook: distribuye el calor de manera uniforme a través del aire caliente a gran velocidad.**
- **Capacidad: 3,0 litros.**
- **Intuitiva y muy fácil de usar: gracias a la pantalla digital se puede ajustar el tiempo (hasta 60 minutos) y la temperatura (de 40°C a 200°C).**
- **Recipiente extraíble con antiadherente 100% libre de PFOA. Libre de BPA.**
- **Fácil limpieza.**

FR

- Technologie TotalCook : distribue la chaleur de manière homogène à travers l'air chaud à grande vitesse.
- Capacité : 3,0 litres.
- Intuitif et très facile à utiliser : grâce à l'affichage numérique, vous pouvez régler le temps (de 1 à 60 minutes) et la température (de 40°C à 200°C).
- Récipient amovible avec revêtement antiadhésif sans PFOA. Sans BPA.
- Facile à nettoyer.

EN

- TotalCook Technology: It distributes heat uniformly with high speed hot air.
- Capacity: 3.0 litres.
- Intuitive and very easy to use: thanks to the digital screen, you can set the time (up to 60 minutes) and temperature (from 40°C to 200°C).
- The removable non-stick container is 100% PFOA free. BPA free.
- Easy to clean.



### Freidora de aire VITALCOOK

Friteuse airfryer · Aidfryer Heißluft-Fritteuse  
 Air fryer · Friteadeira de aire

Ref	€	W	U.Venta
69509	107,60	1000	1

Ref	Tensión/Voltage	Potencia Power	Temp. Temp.	Temporizador Timer	Capacidad cubeta Container capacity	Medidas cubeta Container sizes	Dimensiones Sizes	Peso Weight
69509	220-240 V; 50/60 Hz	1000 W	40°C - 200°C	1 - 60 min	3,0 L	Ø19x9 cm	34x25x33 cm	2,97 Kg



**Tecnología TotalCook: distribuye el calor de manera uniforme a través del aire caliente a gran velocidad**  
 TotalCook Technology: it distributes heat uniformly with high speed hot air.



**Incluye rejilla**  
 Grid included

# SOBREMESA

## Hornos

· Semiprofessional use ·



ES

- Hornos eléctricos de sobremesa de convección con carcasa de acero en acabado negro.
- Capacidad de 28/35 litros y potencia máxima de 1650/1850 W.
- Alto rendimiento en un diseño compacto.
- Manejables y funcionales.
- 5 funciones predefinidas y temporizador de 0-120 minutos con señal sonora.
- Temperatura ajustable máx. de 230°C.
- Transfieren el calor a través de 4 resistencias.
- Pared de aislamiento y puerta abatible de doble cristal de alta resistencia.
- Luz interior que permite vigilar el proceso.
- Revestimiento antiadherente interior para una fácil limpieza. 100% libre de PFOA.
- Incluyen: bandeja para hornear, parrilla, pinza para bandeja, rustidor giratorio, mango para el rustidor y bandeja recogemigas.

FR

- Four électrique à convection à poser avec corps en acier en use finition noire.
- Capacité de 28/35 litres et puissance maximale de 1650/1850W.
- Haut rendement dans un design compact.
- Maniable et fonctionnel.
- 5 fonctions prédéfinies et minuteur de 0 à 120 minutes avec signal sonore.
- Température réglable : max. 230°C
- Transfère la chaleur à travers 4 résistances.
- Paroi isolante et porte rabattable à double vitrage hautement résistante.
- Éclairage intérieur qui permet de contrôler la cuisson.
- Revêtement antiadhésif intérieur pour un nettoyage facile. 100% sans PFOA.
- Inclut un plat lèche-frites, une grille, une pince pour le plat lèche-frites, une broche à rôtir tournante, un manche pour la broche et une plaque de four.

EN

- Electric countertop convection oven with black finish steel use body.
- 28 L/35 L capacity · 1650 W/1850 W max. power.
- High performance in a compact design.
- Highly practical and functional.
- 5 pre-set functions and 0-120 min. timer with audible beep.
- 230°C max. adjustable temperature.
- Transfers heat through 4 heating elements.
- Insulated walls and high-strength, Transfers heat through 4 heating elements.
- Inside light to monitor progress as food cooks.
- Non-stick coating inside for easy cleaning. 100% BPA free.
- Includes baking tray, grill rack, tray tongs, rotating rotisserie spit, spit handle and crumb tray.

### Accesorios · Accessoires · Accessories

Antiadherente interior  
Non-stick interior

Transfiere el calor a través de 4 resistencias  
Transfers heat through 4 heating elements

Puerta abatible de doble cristal  
Double glass hinged door

Bandeja recogemigas  
Crumb tray

Rustidor giratorio  
Rotating rotisserie spit

Parrilla  
Grate

Bandeja de horno  
Oven tray

Pinza para bandeja  
Try tong

Mango para rustidor  
Spit handle



3  
Bandejas  
Trays



4  
Bandejas  
Trays

### Horno sobremesa

Four à poser · Tischbackofen  
Countertop oven · Forno de mesa

Ref	€	W	L	U.Venta
A 69327	217,90	1650	28	1
B 69347	244,70	1850	35	1

Ref	Tensión/Voltage	Potencia/Power	Capacidad/Capacity	Temporizador/Timer	Temp.	D. int/Int. size	Dimensiones/Sizes	Peso/Weight
69327	220-240 V; 50 Hz	1650 W	28 L	0 - 120 min	70°C - 230°C	34,5x28x20 cm	48x30x40 cm	8,20 Kg
69347	220-240 V; 50 Hz	1850 W	28 L	0 - 120 min	70°C - 230°C	36,5x28,5x23 cm	54x34,5x41 cm	9,75 Kg



**Funciones: asar, cocer, hervir, freír, gratinar, tostar y descongelar**  
**2 mandos: temporizador y nivel de temperatura**  
**Capacidad: 12 L con la posibilidad de 5 L adicionales**  
**Reduce el nivel de grasa de los alimentos**  
 Functions: roast, cook, boil, fry, gratin, toast and defrost  
 2 controls, timer and temperature level  
 Capacity: 12 L with the possibility of an additional 5 L  
 Reduce the fat levels in processed food



Mecanismo de ciclo de aire caliente  
Hot air cycle mechanism



### Horno halógeno convección GLASS

Four à convection halogène · Obsttrockner, Elektrisch  
Convection halogen glass oven · Forno de vidrio

Ref	€	W	U.Venta
69312	94,80	1400	1

Ref	Tensión/Voltage	Potencia/Power	Temperatura/Temp.	Capacidad/Capacity	Temporiz./Timer	Dimensiones/Sizes	Peso/Weight
69312	220-240 V; 50/60 Hz	1400 W	125 - 250°C	12,0 L	0 - 60 min.	41x33x31 cm	6,10 Kg

# MICROONDAS

## Colección

· Professional use ·



### Horno microondas PROFESIONAL

Four à micro ondes professionnel · Mikrowelle Professional  
Professional microwave oven · Microondas profesional

Ref	€	W	L	U.Venta
69325	628,40	1000	25	1

Ref	Tensión/Voltage	Potencia/Power	Capacidad/Capacity	Dimensiones int./Int. sizes	Dimensiones/Sizes	Peso/Weight
69325	220-240 V / 50 Hz	1000 W	25 L	32x32x19 cm	51x43x31 cm	14,60 Kg

- Diseñado para uso intensivo, reduciendo el tiempo de calentamiento un 60%.
- Materiales robustos y mayores medidas de seguridad.
- Mayor protección del usuario a radiaciones.
- Base de cerámica plana, sin plato de vidrio.
- Posibilidad de calentar platos grandes.
- Cavidad interior de acero inoxidable (más higiénico).
- Calentamiento homogéneo.

- Conçu pour un usage intensif, réduisant le temps de chauffe de 60%.
- Matériaux robustes et mesures de sécurité accrues.
- Protection plus importante de l'utilisateur vis-à-vis des radiations.
- Base en céramique plate, sans plateau en verre.
- Possibilité de chauffer de grandes assiettes.
- Cavité intérieure en acier inoxydable (plus hygiénique).
- Chauffe homogène.

- Designed for intensive use; reduces heating time by 60%.
- Robust materials and greater safety measures.
- Greater protection against heat for the user.
- Flat ceramic base with no glass plate.
- It can heat large dishes.
- Inside cavity made of stainless steel (more hygienic).
- Even heating.

**New**

Professional use



**Microondas TEMPO**

Micro-ondes · Mikrowelle  
Microwave · Microondas

Ref	€	W	L	U.Venta
69329	487,30	1550	25	1

- Diseñado para uso intensivo, reduciendo el tiempo de calentamiento un 60%.
- Regulador de tiempo mecánico, rápido e intuitivo. Evita pérdida de tiempo en la programación.
- Base de cerámica plana, sin plato de vidrio.
- Posibilidad de calentar platos grandes, fuentes y bandejas de otro formato.
- Cavity interior de acero inoxidable (más higiénico).
- Calentamiento homogéneo.

- Conçu pour un usage intensif, réduisant le temps de chauffe de 60%.
- Contrôleur de temps mécanique, rapide et intuitif. Evite de perdre du temps en programmation.
- Base en céramique plate, sans plateau en verre.
- Possibilité de chauffer de grandes assiettes, poches et plateaux d'autre format.
- Cavité intérieure en acier inoxydable (plus hygiénique).
- Chauffe homogène.

- Designed for intensive use; reduces heating time by 60%.
- Mechanical, fast and intuitive time controller. Avoids wasting time in programming.
- Flat ceramic base with no glass plate.
- It can heat large dishes, other format fonts and trays.
- Inside cavity made of stainless steel (more hygienic).
- Even heating.

Ref	Tensión/Voltage	Potencia/Power	P.salida/ output p.	Capacidad/Capacity	Dim. Interiores Interior sizes	Dimensiones/Sizes	Peso/Weight
69329	220-240 V; 50/60 Hz	1550 W	1000 W	25 L	32x32x19 cm	51x43x31 cm	14,7 Kg

Household use

Plato giratorio de Ø24,5 cm  
Rotating plate Ø24.5 cm

**Microondas WHITE**

Micro-ondes · Mikrowelle  
Microwave · Microondas

Ref	€	W	L	U.Venta
69322	157,90	700	20	1



Ref	Tensión/Voltage	Potencia/Power	Grill	Temporizador/Timer	Capacidad/Capacity	Plato/ Plate	D. interiores/Sizes int.	Dimensiones/Sizes	Peso/Weight
69322	220-240 V; 50 Hz	700 W	NO	30 min	20 L	Ø24,5 cm	31,5x29,7x19,8 cm	45,2x33,5x26,2 cm	11,30 Kg



**Horno microondas con plato giratorio + grill COMBI**

Four micro-ondes avec plateau tournant + Grill · Mikrowelle mit Drehteller + Grill  
Microwave oven with turntable + grill · Microondas com prato giratório + grill

	Ref	€	W	L	U.Venta
<b>A</b>	69323	268,20	800	23	1
<b>B</b>	69324	291,90	900	25	1
<b>C</b>	69330	351,40	900	30	1

Ref	Tensión/Voltage	Potencia/Power	Pot. Grill/Grill power	Capacidad/Capacity	Plato/Plateau	D. int/Int. size	Dimensiones/Sizes	Peso/Weight
69323	220-240 V; 50 Hz	800 W	1000 W	23 L	Ø27 cm	33x32x20,5 cm	48,5x41x29 cm	15,5 Kg
69324	220-240 V; 50 Hz	900 W	1000 W	25 L	Ø31,5 cm	35,5x33x21 cm	51x43x30 cm	14,3 Kg
69330	220-240 V; 50 Hz	900 W	1000 W	30 L	Ø31,5 cm	33x35,5x22,5 cm	52x40x32,5 cm	15,6 Kg

**PLACAS INDUCCIÓN**  
Colección

Professional use



ES

- Placas de inducción rápidas, eficaces, seguras, fiables y de gran capacidad de calentamiento.
- Sus diseños portátiles y compactos resultan ideales para su uso en cualquier lugar.
- Botones táctiles, intuitivos y fáciles de utilizar con un toque suave.
- Dispone de función de bloqueo de seguridad para niños.
- 40% ahorro de tiempo y energía respecto a otras placas convencionales.

FR

- Plaque à induction rapide, efficace, sûre, fiable et d'une grande capacité de chauffe.
- Sa conception portable et compacte est idéale pour une utilisation n'importe où.
- Boutons tactiles, intuitifs et faciles à utiliser avec un toucher doux.
- Dispose d'une fonction de blocage de sécurité pour les enfants.
- 40% de gain de temps et d'économies d'énergies par rapport à d'autres plaques conventionnelles.

EN

- Fast, efficient, safe, reliable induction hob with high heating capacity.
- Its portable and compact design is ideal for use anywhere.
- Intuitive and easy to use soft touch buttons.
- Includes a child safety lock function.
- 40% saving in time and energy compared to other conventional hobs.

Superficie de calentamiento  
Heating surface



Ø12  
cm  
min

Ø28  
cm  
max



IPX3  
proof

Superficie de calentamiento  
Heating surface



Ø12  
cm  
min

Ø28  
cm  
max



**Placa inducción profesional CHEF**

Plaque induction professionnelle · Profi-Induktionsplatte  
Professional induction cooktop · Placa de indução profissional

Ref	€	W	U.Venta
69132	431,40	3500	1

Ref	Tensión/Voltage	Potencia/Power	Niveles Pot. /P. levels	Temperatura/Temp.	Reloj/Timer	Dimensiones/Sizes	Peso/Weight
69132	220-240 V; 50/60 Hz	3500 W	17	35°C - 240°C	0 - 180 min	34x43x12 cm	7,35 Kg
69337	220-240 V; 50/60 Hz	2700 W	10	60°C - 240°C	0 - 180 min	30x39x10 cm	5,40 Kg

**Placa inducción profesional ROCA**

Plaque induction professionnelle · Profi-Induktionsplatte  
Professional induction cooktop · Placa de indução profissional

Ref	€	W	U.Venta
69337	364,70	2700	1

Superficie de calentamiento  
Heating surface



Ø12  
cm  
min

Ø28  
cm  
max



### Placa inducción profesional EASY

Plaque induction professionnelle · Profi-Induktionsplatte  
Professional induction cooktop · Placa de indução profissional

Ref	€	W	U.Venta
69362	370,10	3500	1

Superficie de calentamiento  
Heating surface



Ø12  
cm  
min

Ø28  
cm  
max

Posibilidad de encastrar  
Encastrable option

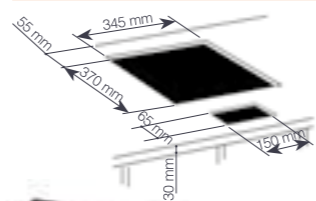

Regulable en potencia  
Adjustable in power

### Placa de inducción PRO

Table de cuisine à induction · Induktionskochfeld  
Induction cooker · Placa de indução

Ref	€	W	U.Venta
69371	333,90	500/3500	1

Ref	Tensión/Voltage	Potencia/Power	Niveles Pot. /P. levels	Niveles Temp. /T. levels	Dimensiones/Sizes	Peso/Weight
69362	220-240 V; 50/60 Hz	3500 W	10 (500W - 800W - 1100W - 1500W - 1800W - 2100W - 2500W - 2800W - 3100W - 3500W)	-	34x44,5x12,5 cm	7,00 Kg
69371	220-240 V; 50/60 Hz	500-3500 W	1-10 (500W (1) - 800W (2) - 1100W (3) - 1500W (4) - 1800W (5) - 2100W (6) - 2500W (7) - 2800W (8) - 3100W (9) - 3500W (10))	10 (60C - 80C - 100C - 120C - 140C - 160C - 180C - 200C - 220C - 240C)	36x38x12,5 cm	6,80 Kg

Superficie de calentamiento  
Heating surface

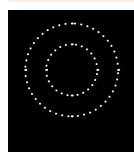

Ø12  
cm  
min

Ø22  
cm  
max

Posibilidad de encastrar  
Encastrable option

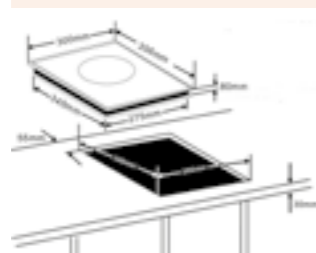

### Placa de inducción EXPERT

Table de cuisine à induction · Induktionskochfeld  
Induction cooker · Placa de indução

Ref	€	W	U.Venta
69032	279,30	2000	1

Superficie de calentamiento  
Heating surface



Ø12  
cm  
min

Ø22  
cm  
max



### Placa de inducción SLIM

Table de cuisine à induction · Induktionskochfeld  
Induction cooker · Placa de indução

Ref	€	W	U.Venta
69332	158,40	2000	1

Ref	Tensión/Voltage	Potencia/Power	Niveles Pot. /P. levels	Reloj/Timer	Dimensiones/Sizes	Peso/Weight
69032	220-240 V; 50/60 Hz	2000 W	6	0 - 180 min	31x36x7,5 cm	2,90 Kg
69332	220-240 V; 50/60 Hz	2000 W	8	0 - 180 min	30x37x4,5 cm	2,67 Kg

Superficie de calentamiento  
Heating surface



Ø22  
cm  
max

Ø12  
cm  
min

Posibilidad de encastrar  
Encastrable option

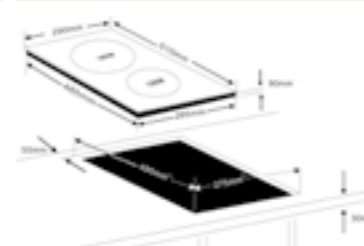

### Placa inducción DUAL VERTICAL

Plaque induction double · Induktionskochfeld doppelt  
Double induction cooktop · Placa de indução dupla

Ref	€	W	U.Venta
69033	457,20	1800+1300	1

Ref	Tensión/Voltage	Potencia/Power	Niveles Pot. /P. levels	Reloj/Timer	Dimensiones/Sizes	Peso/Weight
69033	220-240 V; 50/60 Hz	1800 +1300 W	8	0 - 99 min	29x51x9 cm	4,50 Kg
69333	220-240 V; 50/60 Hz	2000 W + 1500 W	7	0 - 180 min	60x34x7,5 cm	5,20 Kg

Superficie de calentamiento  
Heating surface



Ø22  
cm  
max

Ø12  
cm  
min

Posibilidad de encastrar  
Encastrable option



### Placa inducción DUAL HORIZONTAL

Plaque induction · Induktionskochfeld doppelt  
Induction cooktop · Placa de indução

Ref	€	W	U.Venta
69333	270,20	2000+1500	1

- Cuerpo fabricado en 3 capas: acero inoxidable 18/10, aluminio, acero inoxidable 18%.
- La capa exterior es de acero inoxidable con componentes ferríticos, lo que la convierte totalmente compatible con las cocinas de inducción.
- Los mango fabricado en acero inoxidable 18/10 y recubierto con un protector térmico de silicona
- Body manufactured in a 3-layered: 18/19 stainless steel, aluminium, 18% stainless steel.
- Exterior layer, of stainless steel with ferrite materials, making it completely compatible with induction cookers.
- The grip are made in 18/10 stainless steel and covered in a silicon heat protection.



### Wok Trimetal

Wok Trimetal · Wok, Trimetal  
Trimetal wok · Wok Trimetal



Ref	€	Ø (cm)	L
53836	174,40	36	5,50

Inox

Placa cerámica: Ø26 cm  
Ceramic plate: Ø26 cm

### Placa inducción wok Profesional

Plaque à induction wok professionnelle · Induktionskochplatte wok professional  
Induction cooktop wok professional · Placa indução wok profissional

Ref	€	U.Venta
69138	448,00	1

Ref	Tensión/Voltage	Potencia/Power	Temperatura/Temp	Tiempo/Timer	Dimensiones/Sizes	Peso/Weight
69138	220-240 V; 50/60 Hz	3500 W	60°C - 240°C	0 - 180 min	34x44,5x12,5 cm	7,50 Kg





# ENERGY

## Placa vitrocerámica

Household use



Superficie de calentamiento  
Heating surface



Ø20  
cm  
max

### Placa vitrocerámica ENERGY

Plaque vitroceramique · Keramikkochfeld  
Ceramic hob · Placa vitrocerámica

Ref	€	W	U.Venta
69232	112,30	2000	1

- Placa vitrocerámica rápida, eficaz, segura, fiable y de gran capacidad de calentamiento.
- Su diseño portátil y compacto resulta ideal para su uso en cualquier lugar.
- Área de cocción de 10 cm / 20 cm de diámetro.
- Botones táctiles, intuitivos y fáciles de utilizar con un toque suave.
- Indicadores luminosos.
- Dispone de función de bloqueo de seguridad para niños.
- Regulable en potencia y temperatura.
- Temporizador de 240 minutos con avisador acústico y auto desconexión.

- Plaque vitroceramique rapide, efficace, sûre, fiable et d'une grande capacité de chauffe.
- Sa conception portable et compacte est idéale pour une utilisation n'importe où.
- Zone de cuisson de 10 cm / 20 cm de diamètre.
- Boutons tactiles, intuitifs et faciles à utiliser avec un toucher doux.
- Indicateurs lumineux.
- Dispose d'une fonction de blocage de sécurité pour les enfants.
- Réglable en puissance et en température.
- Minuteur de 240 minutes avec alerte sonore et arrêt automatique.

- Fast, efficient, safe, reliable ceramic hob with high heating capacity.
- Its portable and compact design is ideal for use anywhere.
- 10 cm / 20 cm diameter cooking area.
- Intuitive and easy to use with soft touch buttons.
- Luminous indicators.
- Includes a child safety lock function.
- Adjustable power and temperature.
- 240-minute timer with audible warning and auto-off.

Ref	Tensión/Voltage	Potencia/Power	Temperatura/Temp.	Temporizador/Timer	Ø cocción/Cooking	Dimensiones/Sizes	Peso/Weight
69232	220-240 V; 50/60 Hz	2000 W (8 levels)	60°C - 600°C (8 levels)	0 - 240 min (8 levels)	10 cm / 20 cm	39x32x5,5 cm	2,60 Kg

# PROFESIONAL

## PlANCHAS GRILL

Professional use



Techo móvil  
Mobile roof



### Salamandra PROFESIONAL

Salamandre Professionnelle · Professioneller Grill  
Professional salamander grill · Salamandra Professional

Ref	€	W	U.Venta
69197	1217,50	4000	1

- Estructura de acero inoxidable.
- Ideal para calentar, asar, tostar o gratinar directamente los alimentos.
- Placa de calentamiento y techo móvil, ajusta a la posición deseada.

- Structure en acier inoxydable.
- Idéale pour chauffer, rôtir, griller ou gratiner directement les aliments.
- Plaque de chauffe et toit mobile avec réglage de la position souhaitée.

- Stainless steel structure.
- Ideal for directly heating, roasting, toasting or browning food.
- Movable heating plate and roof, adjusting the desired position.

Ref	Tensión/Voltage	Potencia/Power	Temperatura/Temp.	Plancha/Grill	Dimensiones/Sizes	Peso/Weight
69197	220-240 V; 50/60 Hz	4000 W	50°C - 300°C	59x32 cm	60x45x50 cm	49 Kg

Placa de 12 mm de espesor  
Placa con superficie lisa de acero laminado y rectificado  
12 mm thick plate  
Laminated steel, flat surface griddle



### Placa grill PROFESIONAL

Grill Professionnel · Profi-Grill  
Professional grill plate · Grelhador Professional

Ref	€	W	Área cocción	U.Venta
A 69379	385,50	3000	40x40 cm	1
B 69179	791,90	6000	61x40 cm	1

Ref	Tensión/Voltage	Potencia/Power	Temperat./Temp.	Zona trabajo/Working zone	Superf. placa/Grill surface	Dimensiones/Sizes	Peso/Weight
69379	220-240 V; 50/60 Hz	3000 W	300°C	1	40x40 cm	41x51x26 cm	27 Kg
69179	220-240 V; 50/60 Hz	6000 W	300°C	2	61x40 cm	61,5x51x26 cm	37 Kg

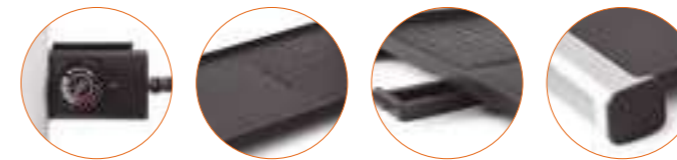

### Plancha Grill QUALITY

Plancha & Grill · Grillplatte  
Grill plate · Prancha & Grelhador

Ref	€	W	U.Venta
69227	84,40	2000	1

Ref	Tensión/Voltage	Potencia/Power	Temperatura/Temp.	Parilla/Grill	Dimensiones/Sizes	Peso/Weight
69227	220-240 V; 50/60 Hz	2000 W	0 - 230°C	52x30 cm	61x32,5x6 cm	3,20 Kg

Professional use

- Fabricada en acero inoxidable.
- Protector de salpicaduras.
- Placa con superficie lisa de acero laminado y rectificado, calentamiento uniforme.
- Control de temperatura por termostato hasta 300°C.
- Depósito recoge grasas.
- Especialmente indicada para bares, restaurantes, hoteles, etc.
- Para hacer a la plancha carnes, pescados, verduras, hortalizas, crepes, huevos, etc.

- Fabriqué en acier inoxydable.
- Protection contre les éclaboussures.
- Plaque avec surface lisse en acier laminé et rectifié, chauffe uniforme.
- Contrôle de température par thermostat jusqu'à 300°C.
- Réservoir ramasse-graisses.
- Spécialement indiquée pour les bars, restaurants, hôtels, etc.
- Pour faire à la plancha des viandes, poissons, légumes, crêpes, œufs, etc.

- Made in stainless steel.
- Splash guard.
- Laminated steel, flat surface griddle with uniform heating.
- Thermostat temperature control up to 300°C.
- Oil collector.
- Especially made for bars, restaurants, hotels, etc.
- To cook meat, fish, vegetables, crepes and eggs on the griddle...

AL  
Aluminum

FU  
Cast



Cuchillas de acero  
inoxidable intercambiables  
Interchangeable st. steel  
blades



### Rasqueta profesional para grill

Racloir professionnel pour grill · Professioneller grillschaber  
Professional grill scraper · Raspador professional para grill

Ref	€	cm	L Cuchilla (cm)	U.Venta
67034	70,70	42x15x12	15	1

Household use

- Placa de aluminio fundido antiadherente de gran calidad, libre de PFOA.
- Doble zona de cocción para cocinar todo tipo de alimentos:
- \* Grill: ideal para asar carnes, pescados, marisco, hamburguesas o verduras.
- \* Lisa: ideal para preparar tortitas, huevos, tostadas o verduras.
- Alcanzan rápidamente la temperatura indicada.
- Garantizan una cocción uniforme por toda la superficie.
- Regulador de temperatura desmontable.
- La ranura central hace que la grasa se deposite en la bandeja recoge-grasas.
- Las asas con recubrimiento aislante de calor proporcionan seguridad.

- High-quality, non-stick, PFOA-free cast aluminium plate.
- Dual cooking area for cooking all kinds of food:
- \* Grill: ideal for grilling meat, fish, seafood, hamburgers or vegetables.
- \* Smooth: ideal for making pancakes, eggs, toast or vegetables.
- Quickly reaches the specified temperature.
- Ensures even cooking across the entire surface.
- Detachable temperature controller.
- Fat runs down the central groove and is gathered in the grease tray.
- Handles with heat-insulating coating for added safety.

# JOIN Raclette Grill

Household use



ES

- Raclette fabricado con carcasa de acero inoxidable y placa de aluminio fundido con antiadherente de máxima calidad. Libre de PFOA.
- Placa reversible que dispone de una superficie acanalada y otra lisa. Superficie de cocción de 41x20 cm.
- Ajuste de temperatura variable (hasta 210°C) con anillo luminoso.
- Resistencia de 1400W distribuida uniformemente por toda la superficie para un calentamiento rápido y uniforme de los alimentos.
- 8 sartenes individuales con revestimiento esmaltado diferenciados por colores. Libres de PFOA.
- 8 espátulas de madera de haya para remover los alimentos y facilitar el momento de servir.
- Protección contra sobrecalentamiento.
- 100% estable: pies antideslizantes.
- Asas termorresistentes.
- Fácil de limpiar; placa y sartenes extraíbles.

FR

- Appareil à raclette fabriqué avec carcasse en acier inoxydable et plaque en fonte d'aluminium avec revêtement antiadhésif de la plus grande qualité. Sans PFOA.
- Plaque réversible qui dispose d'une surface cannelée et d'une autre lisse. Surface de cuisson : 41x20 cm.
- Réglage de température variable (jusqu'à 210°C) avec roulette lumineuse.
- Résistance de 1400W distribuée uniformément sur toute la surface pour une chauffe rapide et uniforme des aliments.
- 8 poêlons individuels avec revêtement émaillé différenciés par couleurs. Sans PFOA.
- 8 spatules en bois de hêtre pour remuer les aliments et faciliter au moment de servir.
- Protection contre la surchauffe.
- 100% stable, pieds antidérapants.
- Poignées thermo-résistantes.
- Facile à nettoyer ; plaque et poêlons extractibles.

EN

- Raclette made with a stainless steel body and a cast aluminium top with a maximum quality non-stick coating, PFOA free.
- Reversible top with a channelled surface and a smooth surface, 41x20 cm cooking surface.
- Variable temperature settings (up to 210° C) with a ring that lights up.
- 1400 W heating element distributed evenly over the entire surface so food can be heated quickly and evenly.
- 8 individual enamel coated frying pans in different colours, PFOA free.
- 8 beech wood spatulas for stirring food and serving.
- Overheating protection.
- 100% stable: non-slip feet.
- Heat-resistant handles.
- Easy to clean, removable top and frying pans.



Apta hasta 8 personas  
Suitable up to 8 people



Termostato regulable con anillo luminoso  
Adjustable thermostat with light ring

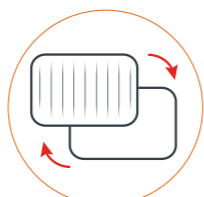

Plancha y parrilla reversibles. Amplía superficie de cocción de 41x20 cm  
Reversible flat and grill plate. Large baking surface of 41x20 cm



8 sartenes individuales diferenciados por colores  
8 individual frying pans differentiated by colors



## Raclette Grill JOIN

Raclette Grill · Raclete-Grill  
Grill raclette · Raclette Grill

Ref	€	W	U.Venta
69348	91,60	1400	1

Ref	Tensión/Voltage	Potencia/Power	Área cocción Cooking area	Área cocción mini sartén Área cocción mini sartén	Dimensiones/Sizes	Peso/Weight
69348	220-240 V; 50/60 Hz	1400 W	41x20 cm	8x8 cm	48x37,5x14,5 cm	2,70 Kg

# TOTALLY & CONTROLLE Grill abatible



New

ES

- Diseñados para preparar sándwiches, paninis, verdura, carne, etc.
- 69572 - DualFunction: grill y plancha de asar; apertura 180° para aprovechar al máximo la superficie de cocinado doble.
- 69573 - Regulador de altura en 4 posiciones: ideal para alimentos delicados. Regulador de temperatura: regula la potencia de las placas para conseguir la cocción deseada (240°C máx).
- Placas de aluminio fundido antiadherente de máxima calidad, ECO y 100% libres de PFOA.
- Disponen de una bandeja de goteo extraíble apta para el lavavajillas.
- GreenLed: indicador luminoso de temperatura.
- TotalSafe: sistema antiquemadura. La carcasa y el asa permanecen fríos durante el uso.

FR

- Conçu pour préparer sandwichs chauds, paninis, légumes, viandes, etc.
- 69572 - DualFunction : grill et plancha ; ouverture à 180° pour exploiter au maximum la surface de cuisson double.
- 69573 - Réglage en hauteur en 4 positions : Idéal pour les aliments délicats. Régulateur de température : Régule la puissance des plaques pour obtenir la cuisson souhaitée (240°C max.).
- Plaques en fonte d'aluminium antiadhésif de la plus grande qualité, ECO et 100% sans PFOA.
- Dispose d'un plateau recueille-gouttes extractible apte pour le lave-vaisselle.
- GreenLed: indicateur de température lumineux.
- TotalSafe : système anti-brûlures. La carcasse et la poignée restent froides pendant son utilisation.

EN

- Designed to prepare sandwiches, paninis, vegetables, meat, etc.
- 69572 - DualFunction: Grill and griddle; fully opens 180° to maximise use of the double cooking area
- 69573 - Height adjustment in 4 positions: ideal for delicate foods. Temperature control: regulates heat of the hotplates to achieve the desired degree of doneness (240°C max.).
- Non-stick cast aluminium hotplates of the highest quality, ECO and 100% PFOA free.
- Features a removable, dishwasher-safe drip tray.
- GreenLed: temperature indicator light.
- TotalSafe: anti-burn system. Housing and handle remain cool during use.



180°

## Grill abatible TOTALLY

Grill rabattable · Klappgrill  
Contact grill · Grelhador rebatível

Ref	€	W	U.Venta
69572	51,40	1500	1

## Grill abatible CONTROLLE

Grill rabattable · Klappgrill  
Contact grill · Grelhador rebatível

Ref	€	W	U.Venta
69573	95,50	1500	1

Ref	Tensión/Voltage	Potencia/Power	Temperatura/Temp.	Área cocción/Cooking area	Dimensiones/Sizes	Peso/Weight
69572	220-240 V; 50/60 Hz	1500 W	180°C	26x16,5 cm (x2)	32x27x11 cm	1,90 Kg
69573	220-240 V; 50/60 Hz	1500 W	240°C	27x17,5 cm (x2)	33,5x28x12,5 cm	2,74 Kg

Professional use



Ideal para preparar carnes, pescados, verduras, bocadillos, etc. Placas onduladas. Placas en hierro colado  
**Placa superior regulable en altura. Abatible hasta 90°**  
**Estructura de acero inoxidable**  
**Mango aislante térmico**  
 Ideal for preparing meat, fish, vegetables, sandwiches, etc.  
 Corrugated plates. Cast iron plates  
 Height adjustable top plate. Folding up to 90°  
 Stainless steel structure  
 Thermal insulating handle

### Plancha Grill

Grill · Grill  
 Grill · Grelhar

Ref	€	W	U.Venta
A 69166	464,00	2200	1 SIMPLE
B 69167	724,20	4400	1 DOBLE · DOUBLE

Ref	Tensión/Voltage	Tensión/Voltage	Potencia/Power	Temp./Temp.	Temp./Temp.	Dimensiones/Sizes	Peso/Weight
69166	SIMPLE	220-240 V; 50/60 Hz	2200 W	300°C / 572°F (max)	50°C / 122°F (min)	31x31x20 cm	25 Kg
69167	DOBLE · DOUBLE	220-240 V; 50/60 Hz	4400 W	300°C / 572°F (max)	50°C / 122°F (min)	57x31x20 cm	35 Kg

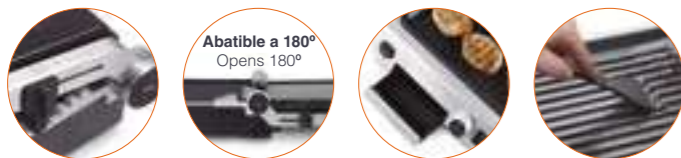

Abatible a 180°  
 Opens 180°

Regulación en altura  
 Height-adjustable



### Grill abatible PRO

Grill rabattable · Klappgrill  
 Contact grill · Grelhador rebatível

Ref	€	W	U.Venta
69574	261,60	2000	1

- Grill de gran calidad y robusto para uso profesional.
- Placas extraíbles de aluminio fundido antiadherente de gran calidad, libre de PFOA.
- Doble zona de cocción:
  - \* Grill (27x22 cm): ideal para asar carnes, pescados, marisco, hamburguesas o verduras.
  - \* Lisa (27x22 cm): ideal para preparar tortitas, huevos, tostadas o verduras.
- Alcanza rápidamente la temperatura indicada. Garantiza una cocción uniforme por toda la superficie.
- Regulación en altura. Regulador de potencia y temporizador de 30 minutos.
- Fácil extracción (botón) y colocación de las placas para facilitar su limpieza.
- Bandeja recoge grasas. Base antideslizante.
- Incluye espátula para la limpieza de las placas.

- Robust, high quality grill for commercial use.
- High quality, non-stick, PFOA-free, cast aluminium grill plates.
- Dual cooking area:
  - \* Grill (27x22 cm): ideal for grilling meat, fish, seafood, hamburgers or vegetables.
  - \* Smooth (27x22 cm): ideal for making pancakes, eggs, toast or vegetables.
- Quickly reaches the specified temperature. Ensures even cooking across the entire surface.
- Height-adjustable. 30-minute timer and power regulator.
- Grill plates are easy to remove (button) and replace, making them easy to clean.
- Drip tray. Non-slip base.
- Includes spatula for cleaning the grill plates.

Ref	Tensión/Voltage	Potencia/Power	Temperatura/Temp.	Temporizador/Timer	Parrilla/Grill	Dimensiones/Sizes	Peso/Weight
69574	220-240 V; 50/60 Hz	2000 W	0 - 230°C	0 - 30 min	27x22 cm	38x35x17 cm	6,0 Kg

# SANDWICHERAS

## Colección

Household use



ES

- Tuesta y sella 2 sandwiches al mismo tiempo y consigue resultados increíbles.
- Placas con revestimiento antiadherente de alta calidad y libres de PFOA.
- Asa termorresistente, manipula la sandwichera con la máxima seguridad.
- Calentamiento rápido y uniforme. Indicadores led de encendido y calentamiento.
- Sistema de cierre y bloqueo sencillo y seguro.
- Compartimento para cable, posibilidad de almacenamiento vertical.
- Patas de goma antideslizantes.

FR

- Grille et presse 2 croques-monsieurs en même temps et obtient des résultats incroyables.
- Plaques dotées d'un revêtement antiadhésif de grande qualité et sans PFOA.
- Poignée thermorésistante afin de manipuler l'appareil en toute sécurité.
- Chauffe rapide et uniforme. Voyants lumineux de mise en marche et de chauffe.
- Système de fermeture et de blocage simple et sûr.
- Compartiment pour câble, possibilité de rangement vertical.
- Pieds en caoutchouc antidérapants.

EN

- Toast and seal 2 sandwiches at once, with incredible results.
- High quality non-stick plates that are PFOA free.
- The thermo-resistant handle lets you handle the sandwich maker with the utmost safety and no fear.
- Fast and even heating. LED power and heating indicators.
- Safe and simple closing and locking system.
- Cable compartment, can be stored vertically.
- Non-slip rubber feet.



### Sandwichera BLACK

Appareil à sandwichs · Sandwichmaker  
 Sandwich toaster · Sanduicheira

Ref	€	W	U.Venta
A 69147	30,80	750	1 Rectangular · Rectangular
B 69148	30,80	750	1 Triangular · triangular

Tuesta y sella 2 sandwiches al mismo tiempo  
 Toast and seal 2 sandwiches at once

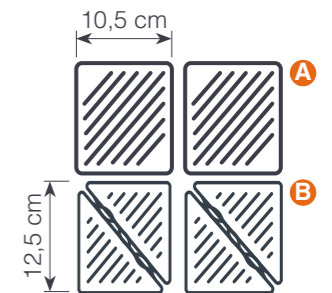

Tuesta y sella 2 sandwiches al mismo tiempo  
 Toast and seal 2 sandwiches at once

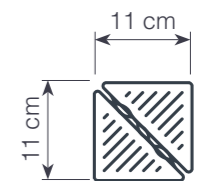

### Sandwichera WHITE

Appareil à sandwichs · Sandwichmaker  
 Sandwich toaster · Sanduicheira

Ref	€	W	U.Venta
69247	35,00	750	1

Ref	Tensión/Voltage	Potencia/Power	Sandwich	Dimensiones/Sizes	Peso/Weight
69247	220-240 V ; 50/60 Hz	750 W	11x11 cm (máx)	23x22x8,5 cm	1,450 Kg
69147	220-240 V; 50/60 Hz	750 W	10,5x12,5 cm (máx)	25x24x11 cm	1,66 Kg
69148	220-240 V; 50/60 Hz	750 W	10,5x12,5 cm (máx)	25x24x11 cm	1,66 Kg

# GOFRERA

## Colección

· Semiprofessional use ·

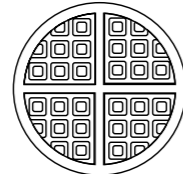

Ø18 cm del gofre  
Waffle Ø18 cm



Placas en hierro colado  
Cast iron plates

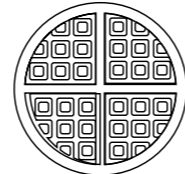

Gofre: Ø20 cm  
Waffle: Ø20 cm



### Gofrera

Gaufrier · Wendewaffeleisen  
Waffle maker · Maquina de fazer gofres

Ref	€	W	U.Venta
69349	303,20	1000	1

### Gofrera Reversible

Gaufrier réversible · Wendewaffeleisen  
Waffle maker · Maquina de fazer gofres reversível

Ref	€	W	U.Venta
69149	57,10	875	1

Ref	Tensión/Voltage	Potencia/Power	Temperat./Temp.	Tiempo/Timer	Placa Gofre/Waffle plate	Dimensiones/Sizes	Peso/Weight
69349	220-240 V; 50/60 Hz	1000 W	50°C - 300°C	5 min	Ø18 cm	26x44x26 cm	7 Kg
69149	220-240 V; 50/60 Hz	875 W			Ø20 cm	34x24x15 cm	1,98 Kg

# REDONDO

## Quemador

· Professional use ·



Incluye soporte  
Includes support

### Quemador eléctrico redondo

Fer à caraméliser électrique rond · Karamellisierer rund  
Round electric caramelizer · Quemador eléctrico redondo

Ref	€	U.Venta
68651	114,70	1
68652	132,40	1

- Fabricada en acero inoxidable 18/10 con mango de plástico negro de excelente calidad.
- Diseñado para aplicaciones en cocina y repostería.
- Consta de una resistencia, que al conectarse a la corriente, se calienta.
- Incluye soporte.

- Fabriqué en acier inoxydable 18/10 avec un manche en plastique noir de haute qualité. Poignée en plastique noir.
- Conçu pour la cuisson et la pâtisserie.
- Composé d'un élément chauffant, qui se réchauffe lorsqu'il est branché sur le secteur.
- Socle inclus.

- Made of 18/10 stainless steel with a high quality black plastic handle.
- Designed for cooking and baking applications.
- Consists of a heating element, which heats up when connected to the mains.
- Includes stand

Ref	Tensión/Voltage	Potencia/Power	Dimensiones/Sizes	Peso/Weight
68651	220-230 V; 50/60 Hz	650 W	Ø10 cm	1,132 Kg
68652	220-230 V; 50/60 Hz	1000 W	Ø12 cm	1,268 Kg

# CREPERAS

## Colección

· Semiprofessional use ·



ES

- Crea crepes dulces y salados, pancakes y tortitas de una manera sencilla y cómoda.
- Rapidez, potencia y un calentamiento uniforme.
- Placa de aluminio antiadherente perfecta para hacer crepes degran tamaño.
- Incluye rastrillo de madera para extender la masa y conseguir un grosor homogéneo y espátula para voltear el crepe.

FR

- Faites des crêpes sucrées et salées, des pancakes et des petites galettes de façon simple et pratique.
- Rapidité, puissance et une chauffe uniforme.
- Plaque en aluminium antiadhésive, parfaite pour faire de grandes crêpes.
- Inclut râtelier en bois pour étaler la pâte et obtenir une épaisseur homogène, et une spatule pour retourner la crêpe.

EN

- Make sweet and savoury crêpes, pancakes and pikelets easily and conveniently.
- Speed, power and uniform heating.
- Non-stick aluminium plate, perfect for making large crêpes.
- Includes a wooden scraper for spreading the batter to achieve uniform thickness and a spatula to flip the crêpe.

Placa de aluminio antiadherente de Ø40 cm  
Non-stick aluminium plate Ø40 cm



Inox

### Placa crepera

Plaque crêpière · Crêpes-Kochplatte  
Crepes maker · Placa crepeira

Ref	€	W	U.Venta
69196	489,20	3000	1

Placa de aluminio antiadherente de Ø30 cm  
Non-stick aluminium plate Ø30 cm



### Crepera

Crêpière · Crêpesplatte  
Crepes maker · Crepeira

Ref	€	W	Color	U.Venta
A 69122	55,10	1000	BLACK	1
B 69222	73,80	1000	WHITE	1
C 69433	108,60	1500	TitanPro	1

New

Ref	Tensión/Voltage	Potencia/Power	Temperatura/Temp.	Placa/Grill	Dimensiones/Sizes	Peso/Weight
69196	220-240 V; 50/60 Hz	3000 W	50°C - 250°C	35 cm	45x49x22,5 cm	23 Kg
69122	220-240 V; 50/60 Hz	1000 W	200°C (max)	Ø30 cm	40x36x11 cm	2,12 Kg
69222	220-240 V; 50/60 Hz	1000 W	240 °C (max)	Ø30 cm	40x39x8 cm	1,72 Kg

New

Placa de aluminio antiadherente de Ø33 cm  
Non-stick aluminium plate Ø33 cm



### Crepera TitanPro

Crêpière · Crêpesplatte  
Crepes maker · Crepeira

Ref	€	W	U.Venta
69433	108,60	1500	1



Placa de aluminio antiadherente de Ø30 cm  
Non-stick aluminium plate Ø30 cm



# CHOCOLATE

## Baño María

· Semiprofessional use ·



Permite fundir chocolate y mantenerlo caliente  
Cazo desmontable de acero inoxidable 18/10 de gran calidad

It allows you to melt chocolate and keep it hot  
High quality 18/10 st. steel collapsible pan



### Baño maría chocolate

Bain marie de chocolat 3 Bain Marie topf für Schokolade  
Chocolate bain marie · Banho-maria chocolate

Ref	€	W	U.Venta
69317	41,70	50	1

Compatible con cubetas GN1/6 de Lacor  
Calentamiento 3D

It's compatible with GN1/6 pans from Lacor  
3D Heating

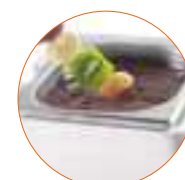

### Baño maría chocolate

Bain marie de chocolat · Bain Marie topf für Schokolade  
Chocolate bain marie · Banho-maria chocolate

Ref	€	W	U.Venta
69617	75,50	80	1

- Funcionamiento sencillo gracias a sus dos posiciones; una para fundir y otra para mantener el calor.
- Prepara fácilmente coberturas para tus postres.
- Añade especias (canela, jengibre en polvo, pimentas, vainilla) para obtener un chocolate más intenso.
- Puedes utilizarlo como una fondue; degustar brochetas de frutas, hojaldres, etc.
- Fonctionnement simple grâce à ses deux positions : l'une pour fondre et l'autre pour maintenir la chaleur.
- Préparez facilement des nappages pour vos desserts.
- Ajoutez des épices (cannelle, gingembre en poudre, poivre, vanille,...) pour obtenir un chocolat plus intense.
- Peut être utilisée comme pour une fondue : déguster des brochettes de fruits, des biscuits feuilletés, etc.
- Easy to use because it has two positions: one for melting and the other for containing heat.
- Make toppings for your desserts easily.
- Add spices (cinnamon, powdered ginger, pepper or vanilla) to get more intense chocolate.
- You can use it for fondue or with fruit skewers, puff pastries, etc.

- Perfecta para elaborar coberturas de alta calidad y mantenerlas a la temperatura deseada durante horas.
- Ideal para la obtención de un glaseado brillante para pasteles, tartas, cake pops, muffins, etc.
- Contenedor GN1/6 (1,50L) y tapa extraíble de acero inoxidable 18/10 para garantizar una rápida y efectiva limpieza (aptos para el lavavajillas).
- Regulación de temperatura por termostato de 0°C a 60°C
- Calentamiento 3D; el calor se distribuye de manera uniforme por toda la superficie del recipiente.
- Luz indicadora, se enciende tan pronto como se alcanza la temperatura deseada.

- Parfait pour élaborer des nappages de grande qualité et les garder à la température souhaitée pendant des heures.
- Idéal pour obtenir un glaçage brillant pour les gâteaux, tartes, cakes pop, muffins, etc.
- Conteneur GN1/6 (1,50L) et couvercle extractible en acier inoxydable 18/10 pour garantir un nettoyage rapide et efficace (compatibles avec le lave-vaisselle).
- Réglage de la température par thermostat de 0°C à 60°C
- Chauffe 3D ; la chaleur est répartie uniformément sur toute la surface du récipient.
- Indicateur lumineux, qui s'allume dès que la température souhaitée est atteinte.

- Perfect for making high quality toppings and keeping them at the desired temperature for hours
- Ideal for getting shiny glazing on pies, cakes, cake pops, muffins, and more
- It has a GN1/6 (1.5 L) container and removable 18/10 stainless steel lid to make cleaning fast and effective. Dishwasher safe.
- The temperature can be regulated with a thermostat from 0°C to 60°C.
- 3D Heating: Heat is distributed evenly over the entire surface of the container.
- The indicator lights up as soon as the desired temperature is reached.

Ref	Tensión/Voltage	Potencia/Power	Temperatura/Temp.	Capacidad/Capacity	Dimensiones/Sizes	Peso/Weight
69317	230-240 V / 50-60 Hz	50 W	40-50°C	1,0 L (máx)	29x22x12 cm	0,875 Kg
69617	230-240 V / 50-60 Hz	80 W	0-60°C	1,5 L (máx)	22,5x26x14,5 cm	1,250Kg

# GREY PLUS

## Fondue

· Household use ·



New



### Fondue GREY PLUS

Fondue · Fondue  
Fondue · Fonduel

Ref	€	W	L	U.Venta
69399	99,20	1500	1,20	1

Ref	Tensión/Voltage	Potencia/Power	Temperat./Temp.	Aceite/Oil	Capacidad/Capacity	Dimensiones/Sizes	Peso/Weight
69399	220-240 V; 50/60 Hz	1500 W	40°C - 95°C	190°C	1,20 L	29,5x21,5x24,5 cm	2,60 Kg

- Fondue eléctrica acabada en acero inoxidable de gran calidad. 1500W de potencia.
- Ideal para fundir queso, chocolate o calentar aceite.
- Olla de acero inoxidable desmontable y de 1,2 L de capacidad con fondo termodifusor para una distribución uniforme del calor.
- Termostato regulable para calentar y mantener los ingredientes siempre calientes.
- Protector antisalpicaduras extraíble con soporte para 8 tenedores.
- Incluye 8 tenedores de acero inoxidable y marcas de colores.
- Apagado de seguridad contra sobrecalentamiento.
- Pies antideslizantes. 100% estable.
- Olla, protector y tenedores aptos para el lavavajillas.

- High quality stainless steel electric fondue set. 1500 W power.
- Ideal for melting cheese, chocolate or heating oil.
- 1.2 L removable stainless steel pot with thermo-diffuser bottom for even heat distribution.
- Adjustable thermostat to heat and keep the ingredients hot at all times.
- Removable splash guard lid that holds 8 forks.
- Includes 8 stainless steel colour marked forks.
- Overheating safety function.
- Non-slip feet. 100% stable.
- Dishwasher safe pot, lid and forks

# CHOCOSWEET

## Chocolatera

· Professional use ·



5,0 l

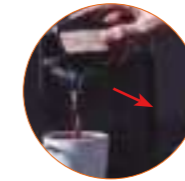

### Chocolatera CHOCOSWEET

Chocolatière · Schokoladenkocher  
Chocolate machine · Chocolateira

Ref	€	W	L	U.Venta
69615	840,00	1000	5,0	1

Ref	Tensión/Voltage	Potencia/Power	Temperatura/Temp.	Capacidad/Capacity	Dimensiones/Sizes	Peso/Weight
69615	220-240 V; 50 Hz	1000 W	0°C - 90°C	5 L	28x41x46,5 cm	6,80 Kg

- Chocolatera profesional diseñada para mezclar y calentar chocolate al baño maría.
- Cubeta de policarbonato de 5 litros de capacidad.
- Termostato regulable de 0°C a 90°C.
- Sensor para prevenir posibles sobrecalentamientos.
- Sistema NonStop: movimiento continuo para conseguir resultados sin grumos y de consistencia perfecta.
- Grifo con sistema antigoteo y antiobstrucción, totalmente desmontable.
- Ideal para bares, restaurantes, cafeterías, hoteles, catering, foodtrucks, etc.
- Bandeja antigoteo con sistema de aviso.
- Base antideslizante. Fácil limpieza.

- Professional chocolate maker designed to mix and heat chocolate in a bain-marie.
- 5 litre capacity polycarbonate container.
- Adjustable 0°C to 90°C thermostat.
- Sensor to prevent possible overheating.
- NonStop System: Continuous motion for lump-free results and perfect consistency.
- Fully detachable tap with anti-drip and anti-clogging system.
- Ideal for bars, restaurants, cafés, hotels, catering, foodtrucks, etc.
- Non-drip tray with warning system.
- Non-slip base. Easy to clean.

# CHOCOLATE Fuentes

· Semiprofessional use ·



## Fuente de chocolate

Fontaine chocolat · Schokoladen Fontäne  
Chocolate fountain · Fonte chocolate

Ref	€	W	Tower	U.Venta
A 69318	60,10	35	18 cm	1
B 69319	102,20	80	38 cm	1

Ref	Tensión/Voltage	Potencia/Power	Temperatura/Temp.	Capacidad/Capacity	Torre/Tower	Dimensiones/Sizes	Peso/Weight
69318	220-240 V; 50/60 Hz	35 W	40°C - 50°C	0,50 L (máx)	18 cm (height)	Ø16x30 cm	1,15 Kg
69319	220-240 V; 50/60 Hz	80 W	40°C - 50°C	1,80 L (máx)	38 cm (height)	Ø23x54,5 cm	2,05 Kg

# DECORACIÓN

## Aerógrafo con compresor

· Professional use ·



## Aerógrafo con compresor

Aérographe avec compresseur · Airbrush Spritzpistole mit Kompressor  
Airbrush with compressor · Aerógrafo com compressor

Ref	€	W	Presión	Caudal	U.Venta
69450	103,20	20	0 - 2 bar	0 - 10 L/min	1

Ref	Tensión Voltage	Potencia Power	Presión Pressure	Caudal aire Air flow	Capacidad Capacity	Long. tubo aire Air tube length	Aerógrafo Airbrush	Med. compresor Compressor size	Peso Weight
69450	220-240 V ; 50/60 Hz	20 W	0 - 2 bar	0 - 10 L/min	7 ml	1,80 m	14,2x2,5x9	11,5x13,5x6 cm	800 g

# CHAFING DISH Eléctrico

· Professional use ·



Cubeta GN 1/1 en Inox (h=65 mm / 8,50 L)  
GN 1/1 st steel container (h=65 mm / 8,5 L)

Tapa y cubeta en inox incluidas  
Stainless steel lid and bucket included



## Chafing dish eléctrico

Chafing dish électrique · Elektrische Chafing Dish  
Electric chafing dish · Chafing dish eléctrico

Ref	€	W	U.Venta
69336	178,10	900	1

Ref	Tensión/Voltage	Potencia/Power	Capacidad/Capacity	Temperatura/Temp.	Cubeta/Container	Dimensiones/Sizes	Peso/Weight
69336	220-240 V / 50-60 Hz	900 W	8,50 L	85°C (+/-10°C)	1GN 1/1 h=65 mm	55x34,5x25 cm	3,90 Kg



## Calentador para chafing

Corp de chauffe pour bain marie · Heizung für chafing dish  
Heating unit for chafing dish · Aquecedor para chafing dish

Ref	€	W	U.Venta
A 69002	185,60	700	1
B 69012	214,70	700	1

Con regulador · With regulator

Ref	Tensión/Voltage	Potencia/Power	Temp./Temp.	Dimensiones/Sizes	Adapt.
69002	220-240 V; 50/60 Hz	700 W	96°C (máx)	25x20 cm	69015-69000
69012	220-240 V; 50/60 Hz	700 W	92°C (máx)	25x20 cm	69001-69004 69110

- Ideal para el sector de la hostelería, restauración y catering.
- Mantiene la temperatura de los alimentos.
- Más seguro al carecer de llama de los geles.
- Tapa y cubeta extraíble GN 1/1 h=65 mm (8,50 L) fabricados en acero inoxidable de alta calidad. Cuerpo fabricado en polipropileno.
- Termostato regulable (85°C +/-10°C).
- Interruptor de encendido y apagado. Indicador luminoso.
- Protección contra sobrecalentamiento.
- Fácil de transportar gracias a sus asas laterales.
- 6 pies antideslizantes y resistentes para mantener la estabilidad.

- Parfait pour le secteur hôtelier, la restauration et le traiteur.
- Conserve la température des aliments.
- Plus sûr parce qu'il n'y a pas de flamme des gels.
- Couvercle et bac amovible GN 1/1 h=65 mm (8,50 L) en acier inoxydable de haute qualité. Corps fabriqué en polypropylène.
- Thermostat réglable (85 °C +/- 10 °C).
- Interrupteur marche/arrêt. Indicateur lumineux.
- Protection contre les surchauffes.
- Facile à transporter grâce à ses poignées latérales.
- 6 pieds antidérapants et résistants pour maintenir la stabilité.

- Ideal for the hospitality, restaurant and catering sectors.
- Maintains temperature of food.
- Safer than chafing dishes that use gel fuels.
- Removable lid and tray GN 1/1 h=65 mm (8.5 L) manufactured in high-quality stainless steel. Body manufactured in polypropylene.
- Adjustable thermostat (85°C +/-10°C).
- On / Off switch. Light indicator.
- Overheating protection.
- Easily portable using the side handles.
- 6 non-slip resistant bases to ensure stability.

## Combinaciones posibles de cubetas · Possible tray options



6002+69012 available for:  
69015 / 69004 / 69110



# CALENTADORAS

## Ollas

Professional use



ES

- Mantiene caliente todo tipo de sopas, salsas, consomés y líquidos.
- Ideal para cantidades grandes.
- Control de temperatura regulable por termostato.
- Cubeta interior desmontable.
- Alta resistencia y durabilidad.

FR

- Maintenir au chaud tout type de soupes, sauces, consommés, liquides, etc.
- Idéal pour de grandes quantités.
- Contrôle de la température réglable par thermostat.
- Seau intérieur amovible.
- Haute résistance et durabilité.

EN

- Keep all kinds of soups, sauces, consommés, liquids etc hot.
- Ideal for large amounts.
- Temperature control adjustable by thermostat.
- Removable inner bucket.
- High resistance and durability.



Inox 18/10



Inox 18/10



Capacidad: 10 L / Medidas: Ø24x25 cm  
Repuesto para las ref.: 69037-69038  
Capacity: 10 l / Sizes: Ø24x25 cm  
Replacement for ref.: 69037-69038

### Olla calentador sopa PROFESIONAL

Marmite Buffet chaud · Suppen- und Speisenwärmer  
Soup kettle · Panela aquecedora de sopa

Ref	€	U.Venta	
A 69267	289,90	1	Inox 18/10 · 18/10 stainless steel
B 69037	173,90	1	Hierro esmaltado · Enameled iron
C 69038	245,20	1	Inox · St steel
D 69039	58,10	1	Repuesto · Replacement (69037-69038)

Ref	Tensión/Voltage	Potencia/Power	Temperatura/Temp.	Capacidad/Capacity	Dimensiones/Sizes	Peso/Weight
69267	220-240 V; 50/60 Hz	800 W	30°C - 90°C	11,0 L	Ø33x32 cm	4,50 Kg
69037	220-240 V; 50/60 Hz	400 - 475 W	30°C - 90°C	10,0 L	Ø34,5x36 cm	4,50 Kg
69038	220-240 V; 50/60 Hz	400 - 475 W	30°C - 90°C	10,0 L	Ø34,5x36 cm	4,50 Kg

# BIBERONES

## Calentador

Professional use



500 ml

### Calentador de botellas biberón

Chauffe-sauces · Flaschenwärmer  
Squeeze bottle warmer · Aquecedor de garrafas dispensadoras

Ref	€	W	U.Venta
69242	244,90	160	1
A R69242H	9,70	-	1

Ref	Tensión/Voltage	Potencia/Power	Temperatura/Temp.	Dimensiones/Sizes	Peso/Weight
69242	220-240 V ; 50/60 Hz	160 W	30°C - 80°C	30,5x25x23 cm	11,0 Kg

- Fabricada en acero inoxidable de alta calidad con aislamiento térmico.
- Sistema de calentamiento en seco y homogéneo.
- Permite mantener calientes preparaciones previamente elaboradas.
- Cómodo y fácil de usar.
- Termostato regulable de temperatura independiente.
- Incluye 2 botellas de 550ml de capacidad con 3 boquillas dispensadoras.
- Compatible con nuestras botellas biberón (Ref.: 61974-61977).

- Fabriqué en acier inoxydable de grande qualité avec isolation thermique.
- Système de chauffe à sec et homogène.
- Permet de garder au chaud les préparations préalablement élaborées.
- Pratique et facile à utiliser.
- Thermostat réglable indépendant.
- Inclut 2 flacons verseurs d'une capacité de 550 ml avec 3 becs verseurs.
- Compatible avec nos flacons verseurs (Réf. : 61974-61977).

- Made of high quality stainless steel with thermal insulation.
- Dry and homogeneous heating system.
- Lets you keep prepared food hot.
- Easy to use and convenient.
- Independent adjustable temperature thermostat.
- Includes two 550 ml bottles with capacity for 3 dispenser mouths.
- Compatible with our squeeze bottles (Ref.: 61974-61977).

# GN 1/1

## Baño María

Professional use



### Baño maría GN 1/1 150 mm

Bain-marie en inox GN 1/1 150 mm · Bain Marie, GN 1/1 150 mm, Rostfrei  
St. steel bain-marie GN 1/1 150 mm · Banho-maria GN 1/1 150 mm

Ref	€	W	U.Venta
69036	233,50	1300	1

Ref	Tensión/Voltage	Potencia/Power	Temperatura/Temp.	Capacidad/Capacity	Dimensiones/Sizes	Peso/Weight
69036	220-240 V; 50/60 Hz	1300 W	85°C	24 L	61,5x39x30 cm	8,50 Kg

Combinaciones de cubetas posibles  
Possible tray options



1 x GN 1/1 - 150



2 x GN 1/2 - 150



3 x GN 1/3 - 150

# PLACA CALENTAMIENTO

## Colección

Professional use



- Una solución perfecta para profesionales de hostelería, buffet, eventos, catering, ferias...
- Ideal para mantener los alimentos calientes antes de servirlos en la mesa a una temperatura perfecta.
- NO cocinar sobre la misma placa.

- Une solution parfaite pour les professionnels de l'hôtellerie, buffets, événements, traiteurs, salons, ...
- Idéale pour garder au chaud d'aliments avant de les servir à table à une température parfaite.
- NE PAS cuisiner sur la même plaque.

- A perfect solution for hospitality, buffet, events, catering and trade show professionals...
- Ideal for keeping the food warm before serving them at a perfect temperature.
- DO NOT cook on the same tray.

### Calentador BUFFET 3x GN 1/3

Chauffe · Warmer  
Warmer · Aquecedor

Ref	€	W	U.Venta
69445	99,70	300	1



### Placa calentamiento

Plaque pour Chauffante · Warmhalteplatte  
Warming Plate · Placa aquecimiento

Ref	€	W	U.Venta
69045	92,50	300	1



### Placa calentamiento Vitrocerámica

Plaque vitrocéramique chaleur · Glaskeramikeizplatte  
Hob heating plate · Placa aquecimiento vitrocerámica

Ref	€	W	U.Venta
69145	204,70	230	1

New



### Placa calentamiento Vitrocerámica

Plaque vitrocéramique chaleur · Glaskeramikeizplatte  
Hob heating plate · Placa aquecimiento vitrocerámica

Ref	€	W	U.Venta
69446	101,30	230	1

Ref	Tensión/Voltage	Potencia/Power	Contenedor/Container	Temp. máx./ Max. temp.	Placa/Plate	Dimensiones/Sizes	Peso/Weight
69445	220-240 V; 50/60 Hz	300 W	GN 1/3 - 2,5 L (3)	80°C (max)	53x35,8 cm	65x38x15,4 cm	4,20 Kg
69045	220-240 V; 50/60 Hz	300 W	-	80°C (max)	53x35,5 cm	65x38x6,2 cm	2,60 Kg
69145	220-240 V; 50/60 Hz	230 W	-	60°C - 105°C (max)	55x36,5 cm	62x36,5x4,5 cm	4,10 Kg
69446	220-240 V; 50/60 Hz	230 W	-	60°C - 105°C (max)	38x45 cm	58x38x2,5 cm	3,54 Kg

# BUFFET

## Calentador

Professional use



ES

- Ideal para grandes cocinas, buffet, catering o comedores.
- Mantiene los platos a temperatura perfecta durante un tiempo prolongado.
- Estructura de acero inoxidable de alta calidad y resistente.
- Placa calentadora de acero inoxidable con regulación de temperatura entre 40°C - 90°C.
- Lámparas halógenas para garantizar una temperatura homogénea con regulación independiente para cada una de ellas.
- Pantalla protectora de plexiglas altamente resistente.

FR

- Idéal pour grandes cuisines, buffets, traiteurs ou cantines.
- Maintient les plats à la température parfaite pendant un laps de temps prolongé.
- Structure en acier inoxydable de grande qualité et résistant.
- Plaque chauffante en acier inoxydable avec réglage de température de 40°C à 90°C.
- Ampoules halogènes pour garantir une température homogène avec réglage indépendant pour chacune d'entre elles.
- Écran de protection en plexiglas hautement résistant.

EN

- Perfect for large kitchens, buffets, catering or dining rooms.
- It keeps food at the perfect temperature for an extended period.
- Durable high quality stainless steel structure.
- Stainless steel heating plate with adjustable temperature from 40° C to 90° C.
- The halogen lamps guarantee even temperature and each one can be adjusted independently.
- High impact perspex safety screen.



Incluye bombillas infrarrojos (Ref.: R69061A)  
Includes infrared heating bulbs



### Calentador BUFFET DUAL

Plaque électrique · Warmhalteplatte  
Electric warming plate · Placa aquecimiento eléctrico

Ref	€	W (Placa)	W (Lámp.)	U.Venta
69562	519,20	500	2x250	1

### Calentador BUFFET TRIPLE

Plaque électrique · Warmhalteplatte  
Electric warming plate · Placa aquecimiento eléctrico

Ref	€	W (Placa)	W (Lámp.)	U.Venta
69563	684,10	650	3x250	1

Ref	Tensión/Voltage	Pot. Placa/Plate P.	Nº Lámp./Lamps	Pot. Lámp./Lamp P.	Temperatura/Temp.	Dimensiones/Sizes	Peso/Weight
69562	220-240 V; 50/60 Hz	500 W	2	250 W	40°C - 90°C	78x53x70 cm	12,5 Kg
69563	220-240 V; 50/60 Hz	650 W	3	250 W	40°C - 90°C	107x53x70 cm	16,5 Kg



# CALENTAMIENTO

## Lámparas

Professional use

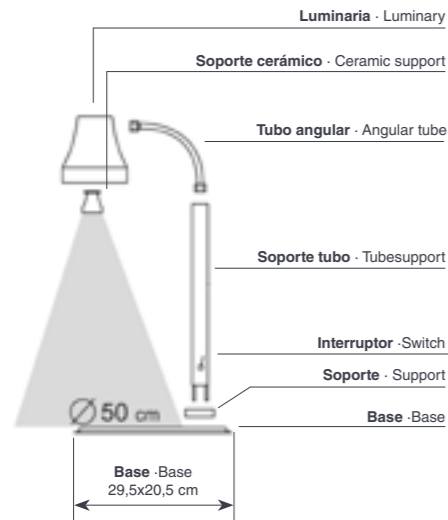

- Para uso profesional en hostelería.
- Mantiene calientes los platos. Calentamiento por infrarrojos.
- Se aconseja mantener la lámpara a 50 - 60 cm de distancia de los platos.
- Bombilla para todas nuestras lámparas de calentamiento.

- Pour un usage professionnel en hôtellerie.
- Maintient les plats au chaud. Chauffe par infrarouges.
- Il est conseillé de maintenir la lampe à une distance de 50 - 60 cm des plats.
- Ampoule pour toutes nos lampes chauffantes.

- For professional catering use.
- Hält die Speisen warm. Infrarot heating.
- It is recommended that the lamp is kept at a distance of 50-60cm from the plates.
- Bulb for all our heating lamps..



Incluye bombillas infrarrojos (Ref.: R69061A)  
Includes infrared heating bulbs

Apta para todas nuestras lámparas de calentamiento  
Suitable for all our heating lamps

**Bombilla infrarrojos**  
Ampoule infrarouge · Infrarot Glühbirne  
Infrared heating bulb · Lampada infravermelho

Ref	€	W	U.Venta
R69061A	9,80	275	1



**Lámpara calentamiento infrarrojos**  
Lampe de chauffage infrarouge · Infrarot Wärmelampe  
Infrared heating lamp · Lampara calor infravermelho

Ref	€	W	U.Venta
A 69361	105,10	275	1
B 69061	145,40	550	1

Ref	Tensión/Voltage	Potencia/Power	Dimensiones/Sizes	Peso/Weight
69361	220-240 V; 50/60 Hz	275 W	34x33x56 -71 cm	1,15 Kg
69061	220-240 V; 50/60 Hz	550 W	36x45x61 - 75 cm	1,58 Kg
69263	220-240 V; 50/60 Hz	275 W	31x23x79 cm	6,0 Kg
69264	220-240 V; 50/60 Hz	550 W	36x36x76 cm	7,0 Kg



**Lámpara de calentamiento infrarrojos**  
Lampe de chauffage infrarouge · Infrarot Wärmelampe  
Infrared heating lamp · Lâmpara calor infravermelho

Ref	€	W	U.Venta
A 69263	473,50	275	1
B 69264	615,50	550	1

# CALENTAMIENTO

## Lámparas extensibles

Professional use



- Para uso profesional en hostelería.
- Mantiene calientes los platos. Calentamiento por infrarrojos.
- Se aconseja mantener la lámpara a 50 - 60 cm de distancia de los platos.
- Bombilla para todas nuestras lámparas de calentamiento.

- Pour un usage professionnel en hôtellerie.
- Maintient les plats au chaud. Chauffe par infrarouges.
- Il est conseillé de maintenir la lampe à une distance de 50 - 60 cm des plats.
- Ampoule pour toutes nos lampes chauffantes.

- For professional catering use.
- Keeps the dishes warm. Infrared heating.
- It is recommended that the lamp is kept at a distance of 50-60cm from the plates.
- Bulb for all our heating lamps.



Incluye bombillas infrarrojos (Ref.: R69061A)  
Includes infrared heating bulbs



**Lámpara calentamiento infrarrojos cable extensible**  
Lampe de chauffage câble extensible · Infrarot Wärmelampe Kabel ausziehbar  
Infrared heating lamp extensible · Lâmpara calor infravermelho cabo extensível

Ref	€	W	U.Venta	Color
A 69266	126,70	275	1	Lijado · Sanding
B 69365	145,60	275	1	Cromado · Chrome
C 69367	145,60	275	1	Cobre · Copper
D 69359	137,40	275	1	Negra · Black <b>New</b>

**Lámpara de calentamiento extensible cónica**  
Lampe chauffante extensible conique · Wärmelampe Kabel ausziehbar, konisch  
Conical heating lamp extensible · Lâmpada de aquecimento ext. cônica

Ref	€	W	U.Venta	Color
A 69564	131,20	275	1	Lijado · Sanding
B 69566	157,50	275	1	Cromado · Chrome
C 69565	160,20	275	1	Cobre · Copper
D 69576	147,00	275	1	Negra · Black <b>New</b>

Ref	Tensión/Voltage	Potencia/Power	Dist. lámp. alimentos / Lamp-food distance	Peso/Weight
69266	220-240 V; 50/60 Hz	275 W	50 - 60 cm	2,00 Kg
69365	220-240 V; 50/60 Hz	275 W	50 - 60 cm	2,00 Kg
69367	220-240 V; 50/60 Hz	275 W	50 - 60 cm	2,00 Kg
69359	220-240 V; 50/60 Hz	275 W	50 - 60 cm	2,00 Kg
69564	220-240 V; 50/60 Hz	275 W	50 - 60 cm	1,60 Kg
69566	220-240 V; 50/60 Hz	275 W	50 - 60 cm	1,60 Kg
69565	220-240 V; 50/60 Hz	275 W	50 - 60 cm	1,60 Kg
69576	220-240 V; 50/60 Hz	275 W	50 - 60 cm	1,60 Kg

# VITRINAS

## Colección

Professional use



**Parte trasera. Puertas traseras abatibles**  
Back side. Hinged rear doors



### Vitrina neutra

Vitrine neutre · Einfache vitrine  
Clear countertop display case · Vitrina neutra

Ref	€	cm	h (cm)	L	U.Venta
69601	285,30	55,4x37,6	37	45	1

- Vitrina neutra construida íntegramente en cristal y base de acero inoxidable.
- Diseñada para presentar y exponer sobre la barra / mostrador.
- Superficie superior curvada para una visión panorámica.
- Estante intermedio de cristal templado.
- Puerta trasera abatible.
- 4 pies de goma que garantizan máxima estabilidad.

- Vitrine neutre intégralement fabriquée en verre et base en acier inoxydable.
- Conçue pour présenter et exposer sur le plan de travail / comptoir.
- Surface supérieure courbée pour une vision panoramique.
- Étagère intermédiaire en verre trempé.
- Porte arrière rabattable.
- 4 pieds en caoutchouc qui garantissent une qualité maximale.

- Clear countertop display case made entirely of glass, including a stainless steel base.
- Designed for presenting and displaying food on the bar/countertop.
- Full view curved upper surface.
- Middle shelf made of tempered glass.
- Hinged rear door.
- 4 rubber feet for maximum stability.



**Parte trasera. Puertas traseras abatibles**  
Back side. Hinged rear doors



**Rejilla extraíble, facilita el flujo del calor**  
Removable racks for better heat flow



### Vitrina térmica

Vitrine thermique · Warmhaltevitrine  
Thermal display case · Vitrina térmica

Ref	€	W	L	U.Venta
69604	577,00	800	45	1

- Vitrina térmica fabricada en acero inoxidable y cristal.
- Diseñada para conservar, presentar y exponer sobre la barra / mostrador.
- Puerta trasera abatible.
- Superficie superior inclinada para una visión panorámica.
- Recipiente de agua extraíble que aporta humedad en la cámara.
- Termostato de control de temperatura regulable: 30-90°C.
- Bandeja de rejilla extraíble que facilita el flujo del calor.

- Vitrine thermique fabriquée en acier inoxydable et verre.
- Conçue pour conserver, présenter et exposer sur le plan de travail / comptoir.
- Porte arrière rabattable.
- Surface supérieure inclinée pour une vision panoramique.
- Récipient d'eau extractible qui apporte de l'humidité à la chambre.
- Thermostat de contrôle pour régler la température : 30-90°C.
- Plateau grillagé extractible qui facilite le flux de chaleur.

- Thermal display case made of stainless steel and glass.
- Designed for storing, presenting and displaying food on the bar/countertop.
- Hinged rear door.
- Full view curved upper surface.
- Removable water tray to keep the chamber moist.
- Adjustable temperature control thermostat: 30-90°C.
- Removable racks for better heat flow.

Ref	Tensión/Voltage	Pot./Power	Capacidad/Capacity	Temp./Temp.	Protec./Protection	Parrilla/Grill	Parrilla/Grill (h)	Dimensiones/Sizes	Peso/Weight
69604	220-240 V; 50 Hz	800	45	30°C - 90°C	IPX4	52,5x28,5 cm	8,5 cm / 10 cm	55,4x37,6x37,6 cm	14,4 Kg



**Parte trasera. Puertas traseras correderas.**  
4 / 6 cubetas gastronorm 1/3 incluidas  
Back side. Sliding rear doors. 4/6 Gastronorm 1/3 trays included

IPX4

A



4  
Cubetas  
Containers

B



6  
Cubetas  
Containers

### Vitrina térmica

Vitrine thermique · Warmhaltevitrine  
Thermal display case · Vitrina térmica

Ref	€	W	Capacidad	U.Venta
A 69602	636,20	500	4xGN1/3	1
B 69603	731,40	800	6xGN1/3	1

Ref	Tensión/Voltage	Potencia/Power	Capacidad/Capacity	Temperatura/Temp.	Protección/Protection	Dimensiones/Sizes	Peso/Weight
69602	220-240 V; 50Hz	500 W	4 x GN 1/3	30°C - 90°C	IPX4	77,3x42x33,6 cm	16 Kg
69603	220-240 V; 50 Hz	800 W	6 x GN 1/3	30°C - 90°C	IPX4	112,7x42x33,6 cm	22 Kg

**Parte trasera**  
Back side



### Vitrina refrigerada

Vitrine réfrigérée · Kühlvitrine  
Refrigerated display case · Vitrina refrigerada

Ref	€	W	L	U.Venta
69607	1084,00	105	40	1

Ref	Tensión/Voltage	Potencia/Power	Capacidad/Capacity	Temperatura/Temp.	Refrigerante/Refr.	Dimensiones/Sizes	Peso/Weight
69607	220-240 V; 50Hz	105 W	40	2°C - 12°C	R600a	68x57,5x33,5 cm	25 Kg

- Vitrina térmica fabricada en acero inoxidable y cristal.
- Diseñada para conservar, presentar y exponer sobre la barra / mostrador.
- Puertas correderas para una accesibilidad total.
- Superficie superior curvada para una visión panorámica.
- 4 / 6 cubetas gastronorm 1/3 incluidas.
- Termostato de control de temperatura regulable: 30 - 90°C.

- Vitrine thermique fabriquée en acier inoxydable et verre.
- Conçue pour conserver, présenter et exposer sur le plan de travail / comptoir.
- Portes coulissantes pour une accessibilité totale.
- Surface supérieure courbée pour une vision panoramique.
- 4 / 6 bacs gastronorm 1/3 inclus.
- Thermostat de contrôle pour régler la température : 30 - 90°C.

- Thermal display case made of stainless steel and glass.
- Designed for storing, presenting and displaying food on the bar/countertop.
- Sliding doors for easy access.
- Full view curved upper surface.
- 4/6 Gastronorm 1/3 trays included.
- Adjustable temperature control thermostat: 30 - 90°C.

69602

Combinaciones posibles  
Possible combinations

GN 2/3	GN 2/3
--------	--------

GN 1/3	GN 1/3	GN 1/3	GN 1/3
--------	--------	--------	--------

69603

Combinaciones posibles  
Possible combinations

GN 2/3	GN 2/3	GN 2/3
--------	--------	--------

GN 1/2	GN 1/2	GN 1/2	GN 1/2
--------	--------	--------	--------

GN 1/3	GN 1/3	GN 1/3	GN 1/3	GN 1/3	GN 1/3
--------	--------	--------	--------	--------	--------

- Vitrina refrigerada construida íntegramente en cristal y acero inoxidable.
- Diseñada para conservar, presentar y exponer sobre la barra / mostrador.
- Puertas correderas para una accesibilidad total.
- Superficie superior inclinada para una visión panorámica.
- Sistema de enfriamiento por compresor. Función Defrost.
- Termostato de control de temperatura regulable: 2-12°C.
- Sist. de iluminación LED en la cámara interior y display de control de mandos.

- Vitrine réfrigérée intégralement fabriquée en verre et acier inoxydable.
- Conçue pour conserver, présenter et exposer sur le plan de travail / comptoir.
- Portes coulissantes pour une accessibilité totale.
- Surface supérieure courbée pour une vision panoramique.
- Système de refroidissement par compresseur.
- Thermostat de contrôle pour régler la température : 0-12°C.
- Syst. d'éclairage LED dans la chambre intérieure et écran de contrôle de commandes.

- Refrigerated display case made entirely of glass, including a st. steel base.
- Designed for storing, presenting and displaying food on the bar/countertop.
- Sliding doors for easy access.
- Full view curved upper surface.
- Compressor cooling system. Defrost function.
- Adjustable temperature control thermostat: 2-12°C.
- LED lighting for inner chamber illumination and control display unit.



# AGUA CALIENTE Dispensador

Household use

Inox CE  



ES

- Ideal para oficinas, casas rurales, reuniones, etc.
- Fácil llenado. Depósito extraíble de gran capacidad (2 L) para llenar fácilmente el contenedor.
- Display intuitivo. Elige la cantidad de agua (150 ml - 230 ml- 300 ml) y la temperatura deseada (25°C - 70°C - 85°C - 95°C).
- Cuenta con función de bloqueo de seguridad.
- Ahorra tiempo y energía. Proporciona la cantidad exacta de agua caliente deseada, el agua restante del depósito se mantendrá fría.
- Bandeja de goteo extraíble e imantada, fácil de limpiar y colocar.

FR

- Idéal pour les bureaux, les gîtes ruraux, les réunions, etc.
- Remplissage facile. Réservoir extractible de grande capacité (2 L) pour remplir facilement le conteneur.
- Écran intuitif. Choisissez la quantité d'eau (150 ml - 230 ml- 300 ml) et la température souhaitée (25°C - 70°C - 85°C - 95°C).
- Dispose d'une fonction de blocage de sécurité.
- Gain de temps et économies d'énergie. Fournit la quantité exacte d'eau chaude souhaitée, l'eau restant dans le réservoir restera froide.
- Plateau d'écoulement extractible et aimanté, facile à nettoyer et à installer.

EN

- Perfect for offices, country homes, meetings, etc.
- Easy to fill. Large capacity (2 L) removable tank to easily fill the container.
- Intuitive display. Choose the amount of water (150 ml - 230 ml- 300 ml) and the desired temperature (25°C - 70°C - 85°C - 95°C).
- Includes safety lock feature.
- Save time and energy. Provides the exact amount of hot water desired, while the remaining water in the tank remains cold.
- Removable and magnetic drip tray, easy to clean and replace.

- Vitrina refrigerada construida íntegramente en cristal y acero inoxidable.
- Diseñada para conservar, presentar y exponer sobre la barra / mostrador.
- Puertas correderas para una accesibilidad total.
- Superficie superior curvada para una visión panorámica.
- Sistema de enfriamiento por compresor.
- 4 / 6 cubetas gastronorm 1/3 incluidas.
- Termostato de control de temperatura regulable: 0-12°C.
- Sistema de iluminación LED en la cámara interior y display de control de mandos.

- Vitrine réfrigérée intégralement fabriquée en verre et acier inoxydable.
- Conçue pour conserver, présenter et exposer sur le plan de travail / comptoir.
- Portes coulissantes pour une accessibilité totale.
- Surface supérieure courbée pour une vision panoramique.
- Système de refroidissement par compresseur.
- 4 / 6 bacs gastronorm 1/3 inclus.
- Thermostat de contrôle pour régler la température : 0-12°C.
- Système d'éclairage LED dans la chambre intérieure et écran de contrôle de commandes.

- Refrigerated display case made entirely of glass, including a stainless steel base.
- Designed for storing, presenting and displaying food on the bar/counter top.
- Sliding doors for easy access.
- Full view curved upper surface.
- Compressor cooling system.
- 4/6 Gastronorm 1/3 trays included.
- Adjustable temperature control thermostat: 0-12°C.
- LED lighting for inner chamber illumination and control display unit.



**Control de temperatura regulable**  
Temperature control thermostat



**Tubo desagüe con tapón**  
Drain tube with cap

**Puertas traseras correderas**  
Sliding rear doors

**4**  
Cubetas  
Containers



**6**  
Cubetas  
Containers



## Vitrina refrigerada

Vitrine réfrigérée · Kühlvitrine  
Refrigerated display case · Vitrina refrigerada

Ref	€	W	Capacidad	U.Venta
<b>A</b> 69605	1236,70	160	4xGN1/3	1
<b>B</b> 69606	1371,10	160	6xGN1/3	1

Ref	Tensión/Voltage	Potencia/Power	Capacidad/Capacity	Temperatura/Temp.	Refrigerante/Refrig.	Dimensiones/Sizes	Peso/Weight
69605	220-240 V; 50Hz	160 W	4 x GN 1/3	0°C - 12°C	R600a	112,1x45x33 cm	33 Kg
69606	220-240 V; 50 Hz	160 W	6 x GN 1/3	0°C - 12°C	R600a	148,3x45x33 cm	39 Kg

**Agua caliente en 5 segundos**  
Hot water in 5 seconds

**Bandeja de goteo extraíble e imantada**  
Removable and magnetic drip tray

## Dispensador de agua caliente

Distributeur d'eau chaude · Heißwasserspender  
Hot water dispenser · Dispensador de água quente

Ref	€	W	U.Venta
69298	124,50	2400	1

Ref	Tensión/Voltage	Potencia/Power	Capacidad/Cap.	Niveles Calentamiento Heating Levels	Dispensado agua Water dispensed	Dimensiones/Sizes	Peso/Weight
69298	220-240 V / 50-60 Hz	2400 W	2,00 L	25°C - 70°C - 85°C - 95°C	150-230-300 ml	32x16,8x32,7 cm	2,50 Kg

# HERVIDORES AGUA

## Colección

· Household use ·



ES

- Hervidor de agua retro fabricado en acero inoxidable 18/10, acabado en gris mate.
- Permite calentar el agua de manera rápida y eficiente.
- Botón luminoso de encendido/apagado.
- Base independiente rotativa de 360°.
- Control STRIX, vida útil superior al controlador estándar. Protección contra el calentamiento en vacío muy preciso. Apagado automático.
- Visor de nivel de agua. Boquilla con filtro. Mango termorresistente.

FR

- Bouilloire rétro fabriquée en acier inoxydable 18/10, finition gris mat.
- Permet de chauffer l'eau de façon rapide et efficace.
- Bouton lumineux de marche/arrêt.
- Base indépendante rotative à 360°.
- Contrôle STRIX, durée de vie utile supérieure au contrôleur standard. Protection contre la chauffe à vide très précis. Arrêt automatique.
- Visualisation du niveau d'eau. Buse avec filtre. Poignée thermo-résistant.

EN

- Retro kettle made of 18/10 stainless steel with a matte grey finish.
- It can be used to heat water quickly and efficiently.
- Illuminated on/off button.
- Independent base rotates 360°.
- STRIX controller: useful life longer than a standard controller. Very precise protection against heating while empty. Automatic Shut-off.
- Water level viewer. Nozzle with filter. Heat-resistant handle.



**Base independiente rotativa de 360°**  
Independent base rotates 360°

**Botón luminoso de encendido/apagado**  
Illuminated on/off button

**Fácil llenado**  
Easy filling

**Interior inox 18/10**  
Interior 18/10 st. steel

**Boquilla con filtro**  
Nozzle with filter

**Indicador de nivel de agua**  
Water level indicator

**Strix**  
Technology

### Hervidor de agua RETRO

Bouilloire électrique · Elektrische Wasserwamer  
Electric kettle · Chaleira eléctrica

Ref	€	W	L	U.Venta
69397	58,20	2200	1,7	1

Ref	Tensión/Voltage	Potencia/Power	Capacidad/Capacity	Dimensiones/Sizes	Peso/Weight
69397	220-240 V ; 50/60 Hz	2200 W	1,70 L	26x19,5x26,5 cm	1,20 Kg



**Filtro extraíble antical**  
Removable anti-cal filter



**Visor de nivel de agua**  
Water level

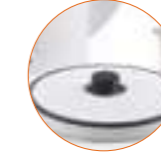

**Base rotativa de 360°**  
360° rotating base



**Calefactor oculto**  
Hidden heater

### Hervidor de agua

Bouilloire · Wasserwamer  
Kettle · Chaleira

	Ref	€	Color	W	L	U.Venta
A	69590	22,60	GREY	2200	1,30	1
B	69591	22,60	WHITE	2200	1,30	1

Ref	Tensión/Voltage	Potencia/Power	Capacidad/Capacity	Dimensiones/Sizes	Peso/Weight
69590	220-240 V; 50/60 Hz	2200 W	1,30 L	20x15x21 cm	0,74 Kg
69591	220-240 V; 50/60 Hz	2200 W	1,30 L	20x15x21 cm	0,74 Kg

**Strix**  
Technology



### Hervidor de agua LAKE

Bouilloire · Wasserwamer  
Kettle · Chaleira

Ref	€	W	L	U.Venta
69277	59,70	2200	1,70	1

Ref	Tensión/Voltage	Potencia/Power	Capacidad/Capacity	Dimensiones/Sizes	Peso/Weight
69277	220-240 V; 50/60 Hz	2200 W	1,70 L (5 min)	23x16x23 cm	1,00 Kg
69291	220-240 V; 50/60 Hz	1630 W	1,00 L (3 min)	22x16x21 cm	1,10 Kg
69297	220-240 V; 50/60 Hz	2200 W	1,70 L (5 min)	22x18x23 cm	1,65 Kg

### Hervidor de agua RAPID

Bouilloire · Wasserwamer  
Kettle · Chaleira

Ref	€	W	L	U.Venta
69291	39,80	1630	1,00	1
69297	49,70	2200	1,70	1



Cristal  
Glass

### Hervidor de agua

Bouilloire · Wasserwamer  
Kettle · Chaleira

Ref	€	W	L	U.Venta
69292	80,70	2200	1,70	1

- Base para conector de 360°.
- Se apagará automáticamente cuando el agua hierve.
- Elemento de calefacción oculto.
- Indicador de luz de encendido/apagado.
- La temperatura se puede ajustar de 50°C-95°C.
- Almacenamiento de cable.

- Base pour connecteur de 360°.
- S'éteint automatiquement lorsque l'eau bout.
- Élément de chauffe caché.
- Indicateur lumineux de marche / arrêt.
- La température peut être réglée entre 50°C et 95°C.
- Rangement du câble.

- Base for 360° connector.
- The wireless boiler will automatically switch off when the water boils.
- Hidden heating element.
- ON/OFF light.
- The temperature can be adjusted from 50°C - 95°C.
- Cable storage.



Protección de ebullición en seco  
Dry boil protection

Ref	Tensión/Voltage	Potencia/Power	Temperatura/Temp.	Capacidad/Capacity	Dimensiones/Sizes	Peso/Weight
69292	220-240 V; 50 Hz	2200 W	50 - 95°C	1,70 L	23x23x32 cm	1,90 Kg

CE  
Ceramic

- Cuerpo cerámico, ecológico y resistente a altas temperaturas.
- Base independiente rotativa de 360°.
- Tapa extraíble con cierre.
- Indicador de capacidad máxima.
- Interruptor de encendido/apagado luminoso.
- Protección de sobrecalentamiento y funcionamiento en seco.
- Función de apagado automático.

- Corps céramique, écologique et résistant aux températures élevées.
- Base indépendante rotative à 360°.
- Couvercle extractible avec fermeture.
- Indicateur de capacité maximale.
- Interrupteur de marche/arrêt lumineux.
- Protection contre la surchauffe et fonctionnement à sec.
- Fonction d'arrêt automatique.

- Ceramic body, ecological and resistant to high temperatures.
- 360° rotating independent base.
- Removable lid with closure.
- Maximum capacity indicator.
- Light up on/off switch.
- Protection from overheating and dry running.
- Auto-off function.



Interior inox 18/10. Calentamiento rápido  
Interior 18/10 st. steel. Fast heating

### Hervidor de agua cerámico

Bouilloire en céramique · Keramik Wasserwamer  
Ceramic kettle · Chaleira cerâmica

Ref	€	Nombre	W	L	U.Venta
A 69276	51,70	GALA	1500	1,20	1
B 69289	56,50	GALA GREY	1200	1,00	1

Ref	Tensión/Voltage	Potencia/Power	Capacidad/Capacity	Dimensiones/Sizes	Peso/Weight
69276	220-240 V; 50/60 Hz	1500 W	1,2 L	24x17x25 cm	1,68 Kg
69289	220-240 V; 50/60 Hz	1200 W	1,0 L	23x16,5x23 cm	1,40 Kg

# AIRPOT Cafetera

Professional use

Inox CE

NO UTILIZAR CON BEBIDAS GASEOSAS, CALDOS NI LÁCTEOS  
DO NOT USE WITH FIZZY DRINKS, BROTHS OR DAIRY

- Dispensador con capacidades de 4, 6 y 10 litros.
- Fabricado en acero inoxidable resistente y de alta calidad.
- Dispone de un grifo dispensador con indicador de nivel de líquido.
- Temperatura controlada por termostato con un rango de 60°C a 100°C.
- Dispone de asas laterales aislantes del calor para un desplazamiento seguro.
- Ideal para agua, café y té.

- Distributeur d'une capacité de 4, 6 litres et de 10 litres.
- Fabriqué en acier inoxydable résistant et de grande qualité.
- Dispose d'un robinet de distribution avec indicateur du niveau de liquide.
- Température contrôlée par thermostat dans une tranche de 60°C à 100°C.
- Dispose de poignées latérales isolantes de la chaleur pour un déplacement sûr.
- Idéal pour l'eau, le café et le thé.

- 4, 6 and 10 litre capacity beverage dispensers.
- Made of strong high quality stainless steel.
- Includes a spigot with a level indicator.
- Temperature controlled by a thermostat with a range from 60°C to 100°C.
- Side mounted insulated handles for safe moving.
- Perfect for water, coffee and tea.



### Airpot eléctrico

Électrique Airpot · Elektrische Getrankenpende  
Electric Airpot · Airpot eléctrico

Ref	€	L	U.Venta
69472	131,00	4	1
69476	141,60	6	1
69471	154,60	10	1

Ref	Tensión/Voltage	Potencia/Power	Capacidad/Capacity	Temperatura/Temp.	Dimensiones/Sizes	Peso/Weight
69472	220-240 V / 50-60 Hz	1500 W	4 L	60°C - 100°C	28x28x35 cm	1,90 Kg
69476	220-240 V / 50-60 Hz	1500 W	6 L	60°C - 100°C	28x28x40 cm	2,00 Kg
69471	220-240 V / 50-60 Hz	1500 W	10 L	60°C - 100°C	28x28x48 cm	2,20 Kg

# PERCOLADA Cafetera

Professional use

Inox CE

- Fabricada en acero inoxidable de gran calidad.
- Ideal para cafeterías, restaurantes, bares, servicios de buffet y estaciones self-service.
- 2 sistemas de calentamiento independientes para la función de infusión y la función de conservación del calor.
- Distribución de calor rápida y homogénea.
- Mantiene el café a la temperatura óptima salvaguardando sus propiedades de sabor y aroma durante horas.
- Filtro de malla microperforada de acero inoxidable, especialmente diseñado para evitar la generación de posos.
- Luz indicadora de preparación. Indicador del nivel de agua. Bandeja antigoteo.
- Tapa con cierre de seguridad mediante botón de bloqueo.
- Sistema de protección contra el calentamiento en vacío.
- Opción de flujo continuo para una máxima comodidad.
- Tapa, filtro y tubo percolador aptos para el lavavajillas.

- Made of high quality stainless steel.
- Perfect for cafés, restaurants, bars, buffet services and self-serve stations.
- Two independent heating systems for the infusion function and the heat preservation system.
- Fast and even heat distribution.
- Keeps coffee at the perfect temperature so it can retain its flavour and aroma for many hours.
- Stainless steel micro-perforated filter specially designed to prevent build-up.
- In-use indicator light. Water level indicator. Anti-drip tray.
- Lid with lock button activated safety lock.
- System to protect against heating while empty.
- Continuous flow option for maximum convenience.
- The lid, filter and percolator tube are dishwasher safe.



Filtro microperforado  
Micro-perforated filter



### Cafetera percoladora

Percolateur à café · Kaffee-Perkolator  
Coffee percolator · Máquina/Percolador de café

Ref	€	W	L	U.Venta
69486	162,90	1500	6	1
69481	181,70	1500	10	1

Ref	Tensión/Voltage	Potencia/Power	Volumen/Volume	Capacidad/Capacity	Dimensiones/Sizes	Peso/Weight
69486	220-240 V; 50 Hz	1500 W	6 L	4,8 L (max)	28x28x40 cm	2,20 Kg
69481	220-240 V; 50 Hz	1500 W	10 L	8,2 L (max)	35x35x45 cm	2,80 Kg

# MOLINILLOS

## Colección

Household use



19 diferentes niveles de molienda · 19 different grind sizes



**Molinillo de café KALDI**  
Moulin à café · Kaffeemühle  
Coffe grinder · Moedor de café

Ref	€	W	g	U.Venta
69485	117,70	200	200 / 100	1



**Ideal para moler café y otros productos como semillas, hierbas, frutos secos, cereales, sal, pimienta, azúcar o especias**

Perfect for grinding coffee or other products like seeds, herbs, nuts, grains, salt, pepper, sugar or spices

**Cuchillas de acero inoxidable de gran resistencia**  
High strength st. steel blades



**Molinillo de café LIMU**  
Moulin à café · Kaffeemühle  
Coffe grinder · Moedor de café

Ref	€	W	g	U.Venta
69385	37,20	200	60	1

- Disfruta de todo el aroma y sabor de un café recién molido.
- Embudo de 200 g de capacidad con tapa.
- Fresa cónica de acero inoxidable, muele el café uniformemente.
- 19 diferentes niveles de molido. Se adapta a todo tipo de cafeteras y a la intensidad de sabor que se desee.
- Selector de tazas de 1 a 12 tazas. Mantiene los granos frescos y evita el desperdicio del café.
- Contenedor transparente extraíble de 100 g. Libre de BPA.

- Profitez de tout l'arôme et du goût du café fraîchement moulu.
- Entonnoir d'une capacité de 200 g avec couvercle.
- Une fraise conique en acier inoxydable, qui moule le café de manière régulière.
- 19 niveaux de mouture différents, elle s'adapte à tous les types de machines à café et à l'intensité de goût souhaitée.
- Sélecteur de tasses de 1 à 12 tasses, il permet de conserver la fraîcheur des grains et d'éviter le gaspillage de café.
- Récipient transparent amovible de 100 g. Sans BPA.

- Enjoy the taste and aroma of freshly ground coffee.
- Hopper with a capacity of 200 g with a lid.
- Conical stainless steel cutter to ensure the coffee is ground uniformly.
- 19 different grind sizes to choose from, suitable for all types of coffee machines and for all flavour intensities.
- Choose between 1 and 12 cups to keep the coffee grounds fresh and avoid wasting coffee.
- Removable 100 g transparent container. BPA-free.



Ref	Tensión/Voltage	Potencia/Power	Capacidad/Capacity	Niveles dispensado Levels dispensed	Niveles de molidos Grinding levels	Dimensiones/Sizes	Peso/Weight
69385	220-240 V ; 50/60 Hz	200 W	60 g (9 cups)	-	-	Ø10x18 cm	0,780 Kg
69485	220-240 V ; 50/60 Hz	200 W	200 g (granos · grains) 100 g (molido · ground)	12	19	15,2x21x26 cm	1,85 Kg

# GOTEO

## Cafeteras

Professional use



- Puede dosificar la cantidad de café.
- Una vez encendida nos podemos desentender de ella.
- Si la jarra se completa, mantiene el café caliente y se puede consumir en cualquier momento.

- Peut doser la quantité de café.
- Une fois allumée, plus besoin de s'en occuper.
- Si la verseuse est pleine, elle maintient le café au chaud permettant ainsi de le consommer à tout moment.

- The amount of coffee used can be controlled.
- Once switched on we can forget about it and leave it to work.
- If a full pot is prepared, it keeps the coffee hot and it can be consumed at any time.



**Cafetera de goteo BLACK**  
Cafetière filtre électrique · Filter-Kaffeemaschine  
Filter coffe machine · Café tipo filtro

Ref	€	W	L	U.Venta
69278	53,70	1000	1,25	1

Ref	Tensión/Voltage	Potencia/Power	Tazas/Cups	Capacidad/Capacity	Dimensiones/Sizes	Peso/Weight
69278	220-240 V; 50/60 Hz	1000 W	10	1,25 L	31x21x22 cm	1,25 Kg
69272	220-240 V; 50/60 Hz	2100 W	-	1,80 L (8 min)	20x36x41 cm	5x82Kg

**Jarra café cristal**  
Basse en verre pichet · Glass Kaffee Krug  
Glass coffee jug · Caneca de café em vidro

Ref	€	L	h (cm)	U.Venta
69273	29,10	1,80	17,50	1



**Pack 200 filtros**  
Pack 200 filters · Pack200 Filter  
Pack filters U.Venta · Pack 200 filtros

Ref	€	Ø (cm)	U.Venta
69274	16,40	25	1
69275	14,10	20	1



**Máquina de café automática**  
Machine à café automatique · Automatische Kaffeemaschine  
Automatic coffee machine · Máquina automática do café

2 Jarras Jugs

2x80 W (80°C +/-4)

1,8 L



**Placas de calentamiento independientes**  
Apta para todas las jarras de cristal  
Independent heating plates  
Suitable for all glass jars

**Placa calentamiento jarra café**  
Plaque chauffante pour cruche de café · Heizplate für Kaffeekanne  
Heating plate for coffee jug · Placa de aquecimento caneca de café

Ref	€	Ø Placa
69282	118,50	11

Ref	€	Ø Placa
69282	118,50	11

Ref	Tensión/Voltage	Potencia/Power	Temperatura/Temp.	Dimensiones/Sizes	Peso/Weight
69282	220-240 V; 50/60 Hz	180 W	80°C + 80°C +/-4	38x20,5x7 cm	1,50 Kg



# CAFETERAS EXPRESSO

## Colección

Household use

Inox CE



Prepara  
1 o 2 cafés  
Make 1 or 2 coffees

Calienta y espuma  
la leche  
Heat and froth milk



### Cafetera espresso SENCE

Cafetière espresso · Espresso-Maschine  
Espresso coffee maker · Cafeteira espresso

Ref	€	W	L	U.Venta
69256	184,20	850	1,50	1

- Cafetera espresso ideal para preparar todo tipo de cafés, espresso, cappuccino, latte machiato, etc.
- Conseguirás un café perfecto y rápido gracias a sus 15 bares de presión.
- Fácil de usar, muy intuitiva. Indicadores luminosos en cada función.
- Función manual y automática. Permite programar el ciclo de vertido a tu gusto.
- Incluye vaporizador con protección para espumar leche y preparar cappuccinos.
- Brazo portafiltros con doble salida, te permite preparar uno o dos cafés a la vez.
- Depósito de agua extraíble de 1,5 litros de capacidad con marcas de máximo y mínimo.
- Bandeja calienta tazas de acero inoxidable, calienta la taza previamente para evitar el contraste térmico.
- Incluye cucharilla dosificadora con prensador para el café y 3 filtros (individual, doble y para usar cápsulas ESE) para acoplar al brazo de la cafetera.
- Bandeja de goteo desmontable con indicador de nivel para facilitar la limpieza.
- Sistema de ahorro energético con apagado automático.
- Apta para usar con café molido y con cápsulas ESE.

- Espresso coffee machine, perfect for making all types of coffee, including espresso, cappuccino, latte, macchiato, etc.
- You'll have a perfect coffee in no time at all thanks to its 15 pressure bars.
- It's easy to use and very intuitive. Each function is accompanied by light indicators
- Manual and automatic settings. You can personalise the pouring time.
- Includes a steam wand with a protector for frothing milk, dispensing hot water for teas and preparing cappuccinos.
- The two-spout filter holder allows you to make one or two coffees at the same time.
- Removable 1.5-litre water tank with minimum and maximum water level marks.
- Stainless steel cup-warming tray heats up the cups before using them to keep the coffee warmer for longer.
- Includes a coffee measuring spoon and tamper and 2 filters (single, double and to use ESE capsules) to attach to the handle.
- Detachable drip tray with water level indicator to aid cleaning.
- Energy-saving system with automatic shut-off.
- Suitable for use with ground coffee and ESE capsules.



Prepara  
1 o 2 cafés  
Make 1 or 2 coffees

Calienta y espuma  
la leche  
Heat and froth milk



### Cafetera espresso COMPACT

Cafetière espresso · Espresso-Maschine  
Espresso coffee maker · Cafeteira espresso

Ref	€	W	L	U.Venta
69429	228,90	1450	1,25	1

- Ideal para preparar todo tipo de cafés, espresso, cappuccino, latte machiato, té o infusiones.
- Su sistema de calentamiento rápido Thermoblock calienta el agua en segundos.
- Fácil de usar, muy intuitiva. Indicadores luminosos en cada función.
- Función manual y automática. Permite programar el ciclo de vertido a tu gusto.
- Incluye vaporizador con rotación para espumar leche y preparar cappuccino. También dispensa agua caliente para las infusiones.
- Brazo portafiltros con doble salida, te permite preparar uno o dos cafés simultáneamente.
- Depósito de agua extraíble de 1,25 litros de capacidad con marcas de máximo y mínimo. Libre de BPA.
- Bandeja calienta tazas de acero inoxidable, calienta la taza previamente para evitar el contraste térmico.
- Incluye cucharilla dosificadora con prensador para el café y 3 filtros (individual, doble y para usar cápsulas ESE) para acoplar al brazo de la cafetera.
- Bandeja de goteo desmontable con indicador de nivel para facilitar la limpieza.
- Sistema de ahorro energético con apagado automático.
- Apta para usar con café molido y con cápsulas ESE.

- It's perfect for making all kinds of coffee, espresso, cappuccino, latte macchiato, tea or infusions.
- Its Thermoblock fast heating system heats water in seconds.
- It is easy to use and very intuitive and has light indicators for every function.
- Manual and automatic operation, the amount of coffee to be made can be programmed to taste.
- Swivelling steam wand included to froth milk and make cappuccino. It also dispenses hot water for infusions.
- The portafilter with two outlets lets you make one or two cups of coffee at the same time.
- It has a removable 1.25 litre water tank with minimum and maximum marks. BPA free.
- It has a stainless steel cup heating tray to heat cups beforehand to prevent temperature contrasts.
- It includes a spoon with a tamper for coffee and three filters (single, double and for using ESE pods) that attach to the portafilter.
- It has a removable drip tray with a level indicator to make cleaning easy.
- It has an energy savings system with automatic shut off.
- It can be used with ground coffee or ESE pods.

Ref	Tensión/Voltage	Potencia/Power	Presión/Pressure	Capacidad/Capacity	Dimensiones/Sizes	Peso/Weight
69429	220-240 V ; 50/60 Hz	1450 W	20 bar	1,25 L	14x31x31 cm	3,40 Kg

Ref	Tensión/Voltage	Potencia/Power	Presión/Pressure	Capacidad/Capacity	Dimensiones/Sizes	Peso/Weight
69256	220-240 V ; 50/60 Hz	850 W	15 bar	1,50 L	21x26,5x30 cm	3,60 Kg



Prepara  
1 o 2 cafés  
Make 1 or 2 coffees

Calienta y espuma  
la leche  
Heat and froth milk



### Cafetera Espresso PRO

Cafetière espresso · Espresso-Maschine  
Espresso coffee maker · Cafeteira espresso

Ref	€	W	L	U.Venta
69428	641,90	1550	2,80	1

- Cafetera espresso de acero inoxidable con acabado pulido.
- Ideal para preparar todo tipo de cafés, espresso, cappuccino, latte machiato, té o infusiones.
- Consigue un café perfecto y rápido gracias a su potencia de 1550 W y sus 20 bares de presión.
- Molinillo con fresa cónica de acero inoxidable integrado que proporciona la cantidad necesaria de café.
- Depósito de café de 250g con opción de regular entre 30 tipos de molido. Libre de BPA.
- Control de temperatura PID. Alcanza la temperatura de extracción óptima.
- Fácil de usar, muy intuitiva. Indicadores luminosos en cada función.
- Función manual y automática. Permite programar la cantidad de vertido a tu gusto.
- Incluye vaporizador con rotación para espumar leche y preparar cappuccino. También dispensa agua caliente para las infusiones.
- Brazo portafiltros con doble salida, te permite preparar uno o dos cafés simultáneamente.
- Depósito de agua extraíble de 2,8 litros de capacidad con marcas de máximo y mínimo. Libre de BPA.
- Incluye prensador de acero inoxidable para el café, 2 filtros (individual y doble) para acoplar al brazo de la cafetera y jarra de acero inoxidable de 0,46 L para la leche.
- Bandeja de goteo desmontable con indicador de nivel para facilitar la limpieza.
- Sistema de ahorro energético con apagado automático.

- Stainless steel espresso maker with a polished finish
- It's perfect for making all kinds of coffee, espresso, cappuccino, latte macchiato, tea or infusions.
- It can make perfect coffee quickly thanks to its 1550 W of power and 20 bars of pressure.
- A coffee grinder with a stainless steel cone burr that provides the right amount of coffee.
- It has a 250 g bean hopper and 30 types of grinding to choose from. It's BPA free.
- PID temperature control, it uses the optimum extraction temperature.
- It is easy to use and very intuitive and has light indicators for every function.
- Manual and automatic operation, the amount of coffee to be made can be programmed to taste.
- Swivelling steam wand included to froth milk and make cappuccino. It also dispenses hot water for infusions.
- The portafilter with two outlets lets you make one or two cups of coffee at the same time.
- It has a removable 2.8 litre water tank with minimum and maximum marks. BPA free.
- It includes a stainless steel tamper for coffee, two filters (single and double) that attach to the portafilter and a 0,46 L stainless steel pitcher for milk.
- It has a removable drip tray with a level indicator to make cleaning easy.
- It has an energy savings system with automatic shut off.

Ref	Tensión/Voltage	Potencia/Power	Presión/Pressure	Capacidad/Capacity	Capacidad/Capacity	Dimensiones/Sizes	Peso/Weight
69428	220-240 V ; 50/60 Hz	1550 W	20 bar	2,80 L (depósito agua)	250 g (depósito café)	31x34,5x41,5 cm	8,00 Kg

# ESPUMADORES LECHE

## Colección



### ES

- Disfruta de una espuma fina y cremosa en pocos segundos.
- Capacidad espuma: 115 ml / Capac. calentamiento: 240 ml (69396) - 250 ml (69398).
- Tecnología magnética, el movimiento de los accesorios se crea por atracción (69398).
- Base independiente rotativa de 360°, fácil de rellenar y verter.
- Funcionamiento silencioso. Apagado automático.
- Indicador de luz que visualiza si la leche está caliente o fría.
- Apta para leches vegetales. Fácil de limpiar.

### FR

- Obtenez une mousse fine et crémeuse en secondes seulement.
- Capacité de mousse : 115 ml / Capacité de chauffe : 240 ml (69396) - 250 ml (69398).
- Technologie magnétique, le mouvement des accessoires a lieu par attraction (69398).
- Base indépendante rotative de 360°C, sans fil, facile à remplir et à verser.
- Fonctionnement silencieux. Arrêt automatique.
- Indicateur lumineux qui indique si le lait est chaud ou froid.
- Apte pour les laits végétaux. Facile à nettoyer.

### EN

- Enjoy a fine, creamy foam in a little seconds.
- Frothing capacity: 115 ml / Heating capacity: 240 ml (69396) - 250 ml (69398).
- Magnetic technology: The movement of the accessories is created with attraction (69398).
- 360° rotating independent base, easy to fill and pour.
- Silent operation. Automatic shut-off.
- The indicator light shows whether the milk is hot or cold.
- Suitable for plant milk and easy to clean.



**Calentar y espumar.**  
Espumar leche fría  
Heat and froth.  
Froth cold milk



**Calentar**  
Heat



### Espumador de leche LATTE

Mousseur à lait · Milchaufschäumer  
Milk frother · Espumador de leite

Ref	€	W	ml	U.Venta
69396	61,80	500	240	1



### Espumador de leche MAGNETIC

Mousseur à lait · Milchaufschäumer  
Milk frother · Espumador de leite

Ref	€	W	ml	U.Venta
69398	76,80	600	250	1

Ref	Tensión/Voltage	Potencia/Power	Cap. espuma/Cap. foam	Cap. leche/Cap. milk	Base/Base	Dimensiones/Sizes	Peso/Weight
69396	220-240 V; 50/60 Hz	500 W	115 ml	240 ml	360°	Ø10x21 cm	650 g
69398	220-240 V; 50/60 Hz	600 W	115 ml	250 ml	360°	Ø11,8x19,5 cm	900 g

# TOSTADORAS BUFFET

## Colección



**Tostado continuo de pan**  
Doble sistema de calentamiento  
Cinta transportadora  
Bandeja de recogida de migas  
Continuous bread toasting  
Dual heating system  
Conveyor belt  
Crumb collection tray

### Tostador CONTINUE

Grille-painl · Toaster  
Toaster · Torradeira

Ref	€	W	U.Venta
69065	835,90	1340	1
69066	964,10	2240	1

Ref	Tensión/Voltage	Potencia/Power	Velocidad/Speed	Producción/Product.	Dimensiones/Sizes	Peso/Weight
69065	220-240 V; 50 Hz	1340 W	0,46 - 0,73 m/min.	150 h	53x37x40 cm	12,85 Kg
69066	220-240 V; 50 Hz	2240 W	0,46 - 0,73 m/min.	300 h	53x45x40 cm	15,50 Kg

**Calentamiento infrarrojos**  
Lámparas infrarrojas halógenas de cuarzo  
Hueco útil entre parrillas 5,5 cm  
Bandeja recogemigas  
Infrared heating Quartz halogen infrared lamps  
Usable gap between racks 5.5 cm  
Crumbs tray



### Tostador HORIZONTAL

Grille-painl · Toaster  
Toaster · Torradeira

Ref	€	W	U.Venta
A 69172	354,30	2400	1
B 69173	418,80	3150	1

Ref	Tensión/Voltage	Potencia/Power	Lámp./Lamps	Parrilla/Grill	Dimensiones/Sizes	Peso/Weight
69172	220-240 V; 50/60 Hz	2400 W	6 (3 + 3)	40x24 cm	50x25x28 cm	7,10 Kg
69173	220-240 V; 50/60 Hz	3150 W	9 (3 + 3 + 3)	40x24 cm	50x25x38cm	9,20 Kg

**Ranuras de grandes dimensiones**  
Bandeja recogemigas  
Huge slots for toasting  
Crumbs tray



### Tostador BUFFET

Grille-painl · Toaster  
Toaster · Torradeira

Ref	€	Ranuras	U.Venta
A 69294	230,70	4	1
B 69296	306,40	6	1

Ref	Tensión/Voltage	Potencia/Power	Selector/Selector	Ranuras/Slots	Dimensiones/Sizes	Peso/Weight
69294	220-240 V; 50/60 Hz	1800 W	2-4 ranuras · 2-4 groves	15x3 cm	29x26x22 cm	3,90 Kg
69296	220-240 V; 50/60 Hz	2500 W	2-4-6 ranuras · 2-4-6 groves	15x3 cm	42x26x22 cm	5,00 Kg



# TOSTADORAS

## Colección

Household use



ES

- Fabricadas en acero inoxidable de máxima calidad y resistencia. Muy robustas.
- Regulador giratorio: 6 niveles de tostado (uniforme y homogéneo).
- Pantalla Led: indica el tiempo restante del tostado.
- Tres funciones: descongelar, recalentar y cancelar.
- Ranuras extra anchas y rejilla para recalentar pan, bollería, etc.
- Bandeja recogemigas extraíble para facilitar su limpieza.
- Recoge cable manual.
- Pies de goma antideslizante para una máxima estabilidad.

FR

- Fabriqué en acier inoxydable de la plus grande qualité et résistance. Très robustes.
- Régulateur giratoire : 6 niveaux de brunissage (uniforme et homogène).
- Écran Led : indique le temps restant.
- Trois fonctions : décongeler, griller et réchauffer.
- Rainures extra larges et grille pour réchauffer le pain, les viennoiseries, etc.
- Plateau ramasse-miettes extractible pour faciliter le nettoyage.
- Enrouleur de câble manuel.
- Pieds en caoutchouc antidérapants pour une stabilité maximale.

EN

- Made of top quality extremely tough stainless steel. Very strong.
- Rotating regulator: 6 toasting levels (even and homogeneous).
- LED Screen: shows the remaining toasting time.
- Three functions: defrost, cancel and reheat.
- Extra wide slots and a grill for reheating bread, pastries, etc.
- Removable crumb tray for easy cleaning.
- Manual cable retractor.
- Non-slip rubber feet for maximum stability.



### Tostadora SMART

Grille-pain · Toaster  
Toaster · Torradeira

Ref	€	W	U.Venta
A 69440	72,90	1500	1
B 69442	62,10	800	1
C 69444	87,50	1750	1

Ref	Tensión/Voltage	Potencia/Power	Ranuras/Slots	D. ranuras/Slots sizes	Dimensiones/Sizes	Peso/Weight
69440	220-240 V; 50/60 Hz	1500 W	2	3,8x25 cm	40,3x17,8x19 cm	2,40 Kg
69442	220-240 V; 50/60 Hz	800 W	2	3,8x14 cm	29,3x17,7x19 cm	1,65 Kg
69444	220-240 V; 50/60 Hz	1750 W	4	3,8x14 cm	28,8x31,5x19 cm	2,80 Kg



Ranuras de grandes dimensiones  
Big slots for toasting



### Tostadora CURVE

Grille-pain · Toaster  
Toaster · Torradeira

Ref	€	W	U.Venta
A 69062	51,80	1000	1
B 69064	78,00	1750	1

Ref	Tensión/Voltage	Potencia/Power	Selector/Selector	Ranuras/Slots	Dimensiones/Sizes	Peso/Weight
69062	220-240 V; 50/60 Hz	1000 W	2 ranuras · 2 slots	14x4 cm	19x29x19 cm	1,40 Kg
69064	220-240 V; 50/60 Hz	1750 W	2-4 ranuras · 2-4 slots	14x4 cm	33x29x19cm	3,10 Kg



### Tostadora horizontal

Toaster horizontal · Horizontal-/Toaster  
Electric toaster · Torradeira horizontal

Ref	€	W	U.Venta
A 69163	33,00	600	1 BASIC
B 69363	41,30	600	1 EASY

Ref	Tensión/Voltage	Potencia/Power	Temperatura/Temp.	Tostado/Toasted	Parrilla/Grill	Dimensiones/Sizes	Peso/Weight
69163	220-240 V; 50/60 Hz	600 W	360°C	6	25x20 cm	36x21x6,5 cm	1,00 Kg
69363	220-240 V; 50/60 Hz	600 W	360°C	6	25x20 cm	42x30x9 cm	1,00 Kg

- Fabricada en acero inoxidable.
- Ranuras de grandes dimensiones (4x14 cm) para tostar cualquier tipo de pan.
- Permite tostar el pan de forma rápida, sencilla, sin ensuciar y sin necesidad de añadir grasa alguna.
- Funciones disponibles: tostar, descongelar, calentar.
- Selección del grado de tueste deseado en progresión continua (REHEAT · BAGEL · NORMAL · CANCEL).
- Expulsión automática.
- Bandeja recogemigas.
- Patas de apoyo antideslizantes.

- Fabriqué en acier inoxydable.
- Fentes de grandes dimensions (4x14 cm) pour faire griller tout type de pain.
- Il permet de faire griller le pain de manière rapide, simple, proprement et sans avoir besoin d'ajouter tous types de matières grasses.
- Fonctions disponibles : griller, décongeler, chauffer.
- Sélection du niveau de cuisson souhaité en progression continue (REHEAT · BAGEL · NORMAL · CANCEL).
- Éjection automatique.
- Tiroir ramasse-miettes.
- Pieds de soutien antidérapants.

- Made of Stainless Steel.
- Large 4 x 14 cm slots for toasting all kinds of bread.
- You can toast bread quickly, easily, without making a mess and without having to use any extra fat.
- Functions: toast, defrost, heat.
- Choose the toasting darkness along a sliding scale (REHEAT · BAGEL · NORMAL · CANCEL).
- Automatic ejection.
- Crumb Tray.
- Non-slip feet.



- Gracias a su diseño y área de calentamiento podrá tostar todo tipo de panes o bollería y varias rebanadas a la vez.
- Grâce à sa conception et sa zone de chauffe, vous pourrez griller tout type de pains ou de viennoiseries et plusieurs tranches à la fois.
- Dank des Designs und des Erwärmungsbereichs können Sie alle möglichen Brotsorten und mehrere Scheiben gleichzeitig toasten.
- Thanks to its design and heating area you will be able to toast all types of bread and pastries, and several slices at a time.
- Graças ao seu desenho e área de aquecimento, poderá tostar todo o tipo de pães ou bolos, e várias fatias ao mesmo tempo.

· Household use ·

## Inox New design



### Tostadora LONG

Grille-pain · Toaster  
Toaster · Torradeira

Ref	€	W	U.Venta
69260	57,60	1500	1

- Tostadora de doble ranura extralarga diseñada para tostar todo tipo de panes.
- Fabricada en acero inoxidable de gran calidad.
- Práctica, segura y muy fácil de usar.
- Función de descongelación (Defrost), calentamiento (Reheat) y cancelación (Stop).
- Bandeja recogemigas para facilitar la limpieza.
- Dispone de 7 niveles de tostado. Medidas de la ranura: 25 x 4 cm.

- Grille-pain à double rainure extra-large conçu pour griller tout type de pains.
- Fabriqué en acier inoxydable de grande qualité.
- Pratique, sûr et très facile à utiliser.
- Fonction de décongélation (Defrost), réchauffage (Reheat) et annulation (Stop).
- Plateau ramasse-miettes pour faciliter le nettoyage.
- Dispose de 7 niveaux de brunissage. Dimensions de la rainure : 25 x 4 cm.

- Extra-long double slot toaster designed to toast all types of bread.
- Made of high quality stainless steel.
- Practical, safe and easy to use.
- DEFROST, REHEAT and CANCEL functions.
- Removable crumb tray for easy cleaning.
- 7 browning levels. Slot dimensions: 25 x 4 cm



**Doble ranura extralarga diseñada para tostar todo tipo de panes**  
Extra-long double slot toaster designed to toast all types of bread

Ref	Tensión/Voltage	Potencia/Power	Ranuras/Slots	Dimensiones/Sizes	Peso/Weight
69260	220-240 V; 50/60 Hz	1400 W	2	38x18x20 cm	1,70 Kg

· Household use ·

- Fabricada en acero inoxidable 18/10 de gran calidad y resistencia
- Permite tostar de forma rápida y sencilla, sin necesidad de añadir grasa alguna
- Función de descongelación y cancelación
- Regulador ajustable de tueste, elige entre 7 niveles para tostar a tu gusto
- Ranura alargada de 25 cm de largo para rebanadas extra largas o para más de una rebanada de pan
- Incorpora una práctica bandeja, donde se depositan las migas

- Fabriqué en acier inoxydable 18/10 d'une grande qualité et résistance
- Permet de griller de façon rapide et simple sans nécessité d'ajouter aucune graisse
- Fonction de décongélation et d'arrêt
- Régulateur de brunissage réglable : choisissez parmi 7 niveaux pour griller selon vos souhaits
- Rainure allongée de 25 cm de longueur pour des tranches extra larges ou pour plus d'une tranche de pain
- Intègre un plateau pratique sur lequel se déposent les miettes

- Made of strong high quality 18/10 stainless steel
- Fast and easy toasting without the need to use any fatty products
- Defrost and cancel functions
- Adjustable darkness regulator. Choose from 7 levels for toasting as you like.
- Long 25 cm slot for extra wide slices of bread or more than one slice of bread at once
- It has a practical tray for catching crumbs



**Ranura extralarga diseñada para tostar todo tipo de panes**  
Extra-long slot toaster designed to toast all types of bread

### Tostadora DUPLO

Grille-pain · Toaster  
Toaster · Torradeira

Ref	€	W	U.Venta
69360	63,70	1000	1

Ref	Tensión/Voltage	Potencia/Power	Ranuras/Slots	Dimensiones/Sizes	Peso/Weight
69360	220-240 V; 50/60 Hz	1000 W	1	41x12x18,5 cm	1,70 Kg

# PROFESIONAL Exprimidor

· Professional use ·



### Exprimidor profesional INOX

Presse-fruits professionnelle · Profi-Zitruspresse  
Professional squeezer · Espremedor profissional

Ref	€	W	U.Venta
69283	435,30	230	1

Ref	Tensión/Voltage	Potencia/Power	Velocidad/Speed	Dimensiones/Sizes	Peso/Weight
69283	220-240 V; 50/60 Hz	230 W	980 r.p.m.	28x20x40 cm	10,50 Kg

Inox  
18/10

AL  
Aluminium

- Cuenta con una potencia de 230 W y materiales de gran calidad para que puedas exprimir todo tipo de frutas y cítricos.
- Sistema de puesta en marcha automático al presionar la palanca.
- Cono de acero inoxidable extraíble, apto para el lavavajillas hasta 90°C.
- Tiempo máximo en funcionamiento continuo: 30 minutos.

- Il possède une puissance de 230 W et des matériaux de grande qualité pour presser tout type de fruits et d'agrumes.
- Système de mise en marche automatique en appuyant sur le levier.
- Amovible cône en acier inoxydable, au lave-vaisselle jusqu'à 90°C.
- Temps de fonctionnement continu maximale: 30 minutes.

- Sie bringt eine Leistung von 230 W und besteht aus hochwertigen Materialien, damit Sie alle Arten von Obst und Zitrusfrüchten auspressen können.
- Automatisches Startsystem bei Drücken des Hebels.
- Abnehmbarer Edelstahl Kegel, spülmaschinenfest bis 90°C.
- Maximale Dauerbetriebszeit: 30 Minuten.

- It has 230 W power and is made from high quality materials so you can make juice from all types of fruits and citric fruits.
- Automatic starting when pressing the lever.
- Removable stainless steel cone, suitable to dishwasher up to 90°C.
- Maximum continuous operating time: 30 minutes.

- Com uma potência de 230 W e fabricado com materiais de grande qualidade, para que possa espremer todo o tipo de frutas e de cítricos.
- Sistema de posta em funcionamento automático ao pressionar a alavanca.
- Cone de aço inoxidável removível, laváveis até 90°C.
- Tempo máximo de funcionamento contínuo: 30 minutos.

Fe  
Hierro  
Iron

AS  
plastic

- Ideal para uso profesional intensivo por su potencia y velocidad, permite extraer el zumo con gran rapidez y sin esfuerzo.
- Constituido por un robusto bloque de hierro fundido.
- 3 conos diferentes, lo que permite obtener el máximo rendimiento de diferentes tipos de cítricos.
- El funcionamiento es muy sencillo: póngalo en marcha con el interruptor de encendido/apagado, coloque un vaso bajo la boquilla y presione las naranjas sobre el cono.
- Un colador separa la pulpa y vierte el zumo a través de la boquilla de salida.
- Incluye protector antisalpicaduras.

- Idéale pour un usage professionnel intensif grâce à sa puissance et sa vitesse, qui permettent d'extraire le jus très rapidement et sans efforts.
- Composée d'un bloc en fonte robuste.
- 3 cônes différents, ce qui permet d'obtenir le rendement maximum de différents types d'agrumes.
- Le fonctionnement est très simple : mettre la machine en marche à l'aide de l'interrupteur de marche/arrêt, placer un verre sous le bec et presser les oranges sur le cône.
- Un filtre sépare la pulpe et verse le jus à travers le bec de sortie.
- Inclut une protection anti-éclaboussures.

- Perfect for intensive professional use thanks to its power and speed, allowing you to quickly and effortlessly extract juice.
- Comprised of a robust cast iron body.
- 3 different cones, giving you optimal performance for different citrus fruits.
- Simple to use: press the on/off button, place a glass beneath the nozzle and squeeze the oranges on the cone.
- A sieve filters the pulp and the juice pours out of the nozzle.
- Includes an anti-splash protector.



### Exprimidor profesional BLACK

Presse-fruits professionnelle · Profi-Zitruspresse  
Professional squeezer · Espremedor profissional

Ref	€	W	U.Venta
69286	218,40	180	1

Ref	Tensión/Voltage	Potencia/Power	Velocidad/Speed	Dimensiones/Sizes	Peso/Weight
69286	220-240 V; 50/60 Hz	180 W	1.350 r.p.m.	31x22x35 cm	4,80 Kg

# EXPRIMIDORES

## Colección



Household use



**ES**

- Exprimidor robusto, seguro y eficiente, aprovecha todo el zumo de los cítricos sin esfuerzo.
- Cuerpo fabricado en acero inoxidable pintado en color blanco.
- Palanca ergonómica para un mejor agarre y un menor esfuerzo.
- Mecanismo potente capaz de exprimir los cítricos sin detenerse y sin pérdidas de potencia.
- Sistema de puesta en marcha automática al presionar la palanca, mantiene una presión suave hasta extraer todo el zumo.
- Sistema de bloqueo de salida de zumo y antigoteo.
- 100% estable: base con 4 ventosas.
- Fácil de limpiar. Accesorios desmontables y aptos para el lavavajillas.

**FR**

- Presse-fruits robuste, sûr et efficace, il presse tout le jus des agrumes sans efforts.
- Corps fabriqué en acier inoxydable peint en blanc.
- Levier ergonomique pour une meilleure prise en main et moins d'efforts.
- Mécanisme puissant capable de presser les agrumes sans s'arrêter et sans perte de puissance.
- Système de mise en marche automatique en appuyant sur le levier, maintenir une pression légère jusqu'à presser tout le jus.
- Système de blocage de la sortie du jus et système anti-goutte.
- 100% stable : base dotée de 4 ventouses
- Facile à nettoyer. Accessoires démontables et compatibles lave-vaisselle.

**EN**

- Strong, safe and efficient squeezer, so that you can effortlessly enjoy all citrus fruit juices.
- Stainless steel body painted in white.
- Ergonomic lever for better grip and minimal effort.
- Powerful mechanism capable of juicing citrus fruits without pausing and without loss of power.
- Automatic start-up upon pressing the lever, keep a light pressure until all juice is extracted.
- Juice output blocking and anti-drip system.
- 100% stable: its base has 4 suction cups for maximum stability.
- Easy to clean. Detachable, dishwasher-safe accessories.



Puesta en marcha automática al presionar la palanca  
 Dos conos para todo tipo de cítricos  
 Sist. de bloqueo de salida de zumo y antigoteo  
 Automatic start-up upon pressing the lever  
 Two cones for all kinds of citrus  
 Anti-drip and juice outlet blockage system

### Exprimidor de palanca VITALLY

Presse-fruit - Zitruspresse  
 Orange squeezer - Espremedor de sumos

Ref	€	W	Color	U.Venta
A 69120	94,20	160	INOX	1
B 69231	126,40	160	WHITE	1

Ref	Tensión/Voltage	Potencia/Power	Dimensiones/Sizes	Peso/Weight
69120	220-240 V; 50/60 Hz	160 W	19,5x29x29 cm	2,50 Kg
69231	220-240 V; 50/60 Hz	160 W	19,5x29x29 cm	2,50 Kg



Puesta en marcha automática al presionar la palanca  
 Dos conos para todo tipo de cítricos  
 Sist. de bloqueo de salida de zumo y antigoteo  
 Automatic start-up upon pressing the lever  
 Two cones for all kinds of citrus  
 Anti-drip and juice outlet blockage system

### Exprimidor de palanca ENERGY

Presse-fruit - Zitruspresse  
 Orange squeezer - Espremedor de sumos

Ref	€	W	U.Venta
69285	66,10	100	1

Ref	Tensión/Voltage	Potencia/Power	Dimensiones/Sizes	Peso/Weight
69285	220-240 V; 50 Hz	100 W	Ø20x29 cm	1,75 Kg

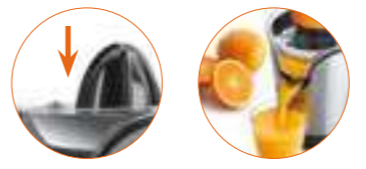

Accionamiento y puesta en marcha presionando el cono hacia abajo  
 Sist. de bloqueo de salida de zumo y antigoteo  
 Activate just by pressing the cone downwards  
 Anti-drip and juice outlet blockage system

### Exprimidor de zumos

Presse-fruit - Zitruspresse  
 Orange squeezer - Espremedor de sumos

Ref	€	W	U.Venta	
A 69287	66,80	100	1	SPIRIT
B 69280	54,80	100	1	POWER

Ref	Tensión/Voltage	Potencia/Power	Dimensiones/Sizes	Peso/Weight
69287	220-240 V; 50/60 Hz	100 W	18x16,5x25 cm	1,90 Kg
69280	220-240 V; 50/60 Hz	100 W	Ø14,5x25 cm	1,68 Kg



Accionamiento y puesta en marcha presionando el cono hacia abajo  
 Dos conos para todo tipo de cítricos  
 Sistema de pulpa regulable  
 Activate just by pressing the cone downwards  
 Two cones for all kinds of citrus  
 Adjustable pulp system

### Exprimidor de zumos ZITRUS

Presse-fruit - Zitruspresse  
 Orange squeezer - Espremedor de sumos

Ref	€	W	L	U.Venta
69575	23,80	40	0,75	1

Ref	Tensión/Voltage	Potencia/Power	Capacidad/Capacity	Dimensiones/Sizes	Peso/Weight
69575	220-240 V; 50/60 Hz	40 W	750 ml (26 oz)	Ø19x20,5 cm	0,820 Kg



Con tapa  
 With lid



Jarra extraíble graduada de 750 ml/26 onzas  
 Removable 750ml/26oz capacity measuring jug

# AUTOMÁTICO

## Exprimidor



ES

- Exprimidor totalmente automático, gracias a su innovadora tecnología la fruta se exprime pulsando solo un botón.
- Mecanismo muy eficaz que exprime hasta la última gota del jugo de frutas.
- Gracias a su innovadora tecnología, no es necesario controlar la preparación del zumo.
- Cono universal que exprime sin problemas el jugo de los pomelos, naranjas, limones o limas.
- Sistema de bloqueo de salida de zumo y protección antigoteo.
- Sin salpicaduras durante el funcionamiento gracias a su tapa cerrada.
- Patas de goma antideslizantes.
- Todas las piezas son desmontables para una fácil limpieza y aptas para lavavajillas.

FR

- Presse-agrumes entièrement automatique ; les fruits sont pressés en appuyant sur un bouton.
- Mécanisme puissant qui presse jusqu'à la dernière goutte du jus des fruits.
- Grâce à sa technologie innovante, il n'est pas nécessaire de surveiller la préparation du jus.
- Cône universel qui presse sans problèmes le jus des pamplemousses, oranges, citrons ou citrons verts.
- Système de blocage de sortie et protection anti-goutte.
- Sans éclaboussures pendant le fonctionnement grâce à son couvercle fermé.
- Pieds en caoutchouc antidérapants.
- Toutes les pièces sont démontables pour un nettoyage facile, et aptes pour le lave-vaisselle.

EN

- This totally automatic juicer squeezes fruit with the touch of a button.
- It's powerful mechanism squeezes out the last drop of fruit juice.
- Thanks to its innovative technology, you don't have to watch whether it makes the juice.
- The universal cone easily squeezes juice from grapefruit, oranges, lemons and limes.
- It has a system for juice outlet blocking and drip protection.
- It doesn't splash while running thanks to its closed lid.
- Non-slip rubber feet.
- All the parts are removable for easy cleaning and they're also dishwasher safe.



### Exprimidor automático

Presse-agrumes automatique · Automatische Saftpresse  
Automatic juicer · Espremedor automático

Ref	€	W	ml	U.Venta
69520	82,60	60	400	1

Ref	Tensión/Voltage	Potencia/Power	Capacidad/Capacity	Dimensiones/Sizes	Peso/Weight
69520	220-240 V; 50/60 Hz	60 W	400 ml	20x19x31 cm	1,75 Kg



# LICUADORAS

## Colección



Los residuos son recogidos automáticamente  
The residues are automatically collected



Tubo de entrada XL  
XL inlet tube

Tapón  
Plug

**Licuada profesional PRO**  
Centrifugeuse professionnelle · Professioneller Zitrus entsafter  
Professional juice extractor · Liquidificador profesional

Ref	€	W	Kg/h	U.Venta
69488	1139,10	700	120	1

Ref	Tensión/Voltage	Potencia/Power	Par mot./M. torque	Conten. residuos/Waste container	Ø Entrada/Entry	Dimensiones/Sizes	Peso/Weight
69488	220-240 V; 50 Hz	700 W	2,9 Nm	6,0 L	9 cm	47,3x25,3x52,2 cm	13,20 Kg

Los residuos son recogidos automáticamente  
The residues are automatically collected



Tubo de entrada XL  
XL inlet tube

Incluye jarra de 1 L  
1 l jar included

**Licuada NUTRITY**  
Fruit centrifugeuse · Zitrus entsafter  
Juice extractor · Liquidificador de sumos

Ref	€	W	L	U.Venta
69288	97,50	850	1,0	1

Ref	Tensión/Voltage	Potencia/Power	Par mot./M. torque	Cap.Capacity	Cont/ Container	Ø Entrada/Entry	Dimensiones/Sizes	Peso/Weight
69288	220-240 V; 50 Hz	850W	0,387 Nm	1,00 L	2,0 L	7,5 cm	30x20x36 cm	4,10 Kg

Professional use

- Fabricada en acero inoxidable de alta calidad muy robustas y potentes.
- Diseñada para uso continuo.
- Su potente motor, su gran velocidad y su gran orificio de entrada permiten preparar de forma rápida nutritivos zumos de frutas o verduras con expulsión automática de la pulpa.
- Contenedor de residuos de gran tamaño.
- Mecanismo de cierre con interruptor de seguridad.
- Filtro microperforado de acero inoxidable.
- Componentes desmontables, fáciles de limpiar.

- Fabriquée en acier inoxydable de grande qualité, très robuste et puissante. Conçue pour un usage continu.
- Son puissant moteur, sa grande vitesse et son large orifice d'entrée permettent de préparer rapidement des jus de fruits ou de légumes nutritifs avec une expulsion automatique de la pulpe.
- Conteneur de déchets de grande contenance.
- Mécanisme de fermeture avec interrupteur de sécurité.
- Filtre micro-perforé en acier inoxydable.
- Composants démontables, faciles à nettoyer.

- Extremely robust and powerful blender made of high quality stainless steel. Designed for continuous use.
- With its powerful motor, high speed, extra large opening and automatic pulp expulsion you can make nutritious fruit or vegetable juice quickly.
- Large waste container.
- Closing mechanism with a safety switch.
- Stainless steel micro-perforated filter.
- Easy to clean removable components.

Household use

- Fabricada en acero inoxidable de alta calidad muy robusta y potente.
- Diseñada para uso continuo.
- Su potente motor, su gran velocidad y su gran orificio de entrada permiten preparar de forma rápida nutritivos zumos de frutas o verduras con expulsión automática de la pulpa.
- Contenedor de residuos de gran tamaño.
- Mecanismo de cierre con interruptor de seguridad.
- Filtro microperforado de acero inoxidable.
- Componentes desmontables, fáciles de limpiar.

- Fabriquée en acier inoxydable de grande qualité, très robuste et puissante. Conçue pour un usage continu.
- Son puissant moteur, sa grande vitesse et son large orifice d'entrée permettent de préparer rapidement des jus de fruits ou de légumes nutritifs avec une expulsion automatique de la pulpe.
- Conteneur de déchets de grande contenance.
- Mécanisme de fermeture avec interrupteur de sécurité.
- Filtre micro-perforé en acier inoxydable.
- Composants démontables, faciles à nettoyer.

- Extremely robust and powerful blender made of high quality stainless steel. Designed for continuous use.
- With its powerful motor, high speed, extra large opening and automatic pulp expulsion you can make nutritious fruit or vegetable juice quickly.
- Large waste container.
- Closing mechanism with a safety switch.
- Stainless steel micro-perforated filter.
- Easy to clean removable components.



**Exprime frutas y verduras enteras**  
Whole fruit / vegetables

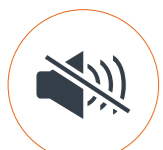

**Bloqueo de salida**  
Juice stopper



*Household use*

- Tecnología "SLOW". Mediante el sistema de rotación lenta y el método de prensado en frío, permite obtener todos los nutrientes de frutas y verduras a diferencia de los exprimidores tradicionales. Ultrasilencioso gracias a su motor de bajas revoluciones.
- Mezcla frutas y verduras en el interior del recipiente antes de verterlo en la jarra.
- Introduce los ingredientes enteros permitiendo acelerar el tiempo dedicado a la extracción del zumo.
- Fácil limpieza. Cepillo para limpiar las partes internas. Accesorios aptos para el lavavajillas.

- Technologie "LENTE". Par son Systeme de rotation lente et la méthode de pression, cela permet de récupérer le maximum des ingrédients du fruit et légume à la différence des presses fruits traditionnels. Ultra silencieux. Grace à son moteur à basse tours.
- Capuchon à jus permettant de mélanger les fruits et légumes à l'intérieur du récipient avant de les verser dans les pichets.
- Introduire entièrement les fruits et légumes, gain de temps.
- Facile à nettoyer. Brosse fournit. Accessoires compatibles lave vaisselle.

- "SLOW" Rotation Engine. The slow rotation system facilitates a cold squeeze that allows the juice preserve all the nutritional properties from vegetables and fruits, unlike traditional squeezers. Ultra-silent. It's engine works in silence and eliminates unnecessary noise.
- Mixes all the desired fruits and vegetables inside the container before serving.
- The slow juicer lets you work with whole fruits and big pieces of vegetables.
- Easy cleaning. A brush incorporated for the inner parts. All pieces are dishwasher compatible.



Incluye **RECETARIO**  
RECIPE BOOK included

### Licuada ECOLO

Fruit centrifugeuse · Zitrus entsafter  
Juice extractor · Liquidificador de sumos

Ref	€	W	U.Venta
69373	411,20	240	1

Ref	Tensión/Voltage	Potencia/Power	Velocidad/Speed	Capacidad/Capacity	Dimensiones/Sizes	Peso/Weight
69373	230 V; 50/60 Hz	240 W	60 r.p.m	1,0 L	29x20x44 cm	7,30 Kg

## SOAK

### Procesador de alimentos

*Household use*



**4**  
Cuchillas  
Blades

### Procesador de alimentos SOAK

Robot culinaire · Küchenmaschine  
Food processor · Processador de alimentos

Ref	€	W	L	U.Venta
69380	208,50	450	1,7	1

- Cocine sopas caseras, salsas, purés, cremas, batidos, zumos, cócteles, etc.
- Saltear ingredientes, cocinar a fuego lento o hervir sopas.
- Mezcla los ingredientes durante el proceso de cocción.
- Pica hielo en menos de 50 segundos y mezcla desde batidos hasta cócteles congelados.

- Cuisinez des soupes maison, des sauces, des purées, des crèmes, des milk-shakes, des jus de fruit, des cocktails, etc
- Sauter les ingrédients, cuisiner à feu doux ou faire bouillir des soupes.
- Mélange les ingrédients pendant le processus de cuisson.
- Pile la glace en moins de 50 secondes et mélange aussi bien des milk-shakes que des cocktails congelés.

- Prepare home-made soups, sauces, purées, creams, milkshakes, juices, cocktails, etc.
- Sautéing ingredients, cooking at low heat or boiling soups.
- Mixes the ingredients during the cooking process.
- Crushes ice in under 50 seconds and mixes anything from milkshakes to frozen cocktails.

Ref	Tensión/Voltage	Potencia/Power	Calentamiento/Heating	Velocidad/Speed	Capacidad/Capacity	Dimensiones/Sizes	Peso/Weight
69380	220-240 V; 50/60 Hz	450 W	700 - 900 W	17.000 r.p.m.	1,70 L	25x21x45 cm	2,40 Kg

## PRO & MIX/GO

### Batidora personales

*Household use*

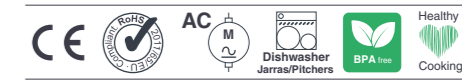

ES

- Elabora sin esfuerzo batidos, cremas y zumos de fruta y verdura en segundos.
- Dispone de un potente motor de 1200 W diseñado para batir con facilidad (69389).
- Protección contra sobrecalentamiento.
- Las cuchillas de acero inoxidable pulverizan las semillas, cortan las pieles y trituran las partes densas y fibrosas de los alimentos hasta el punto de mantener la máxima cantidad de nutrientes.
- Funcionamiento muy sencillo, solo hay que presionar la jarra para que el motor active las cuchillas (69389).
- Incluye dos jarras de tritán libres de BPA (69389 - 1 L / 0,5 L) / (69382 - 600 ml / 300 ml), dos tapas y un asa que se acopla a los vasos para facilitar su agarre (69389).

FR

- Qui prépare sans efforts des smoothies, des crèmes et des jus de fruits et de légumes en quelques secondes.
- Dispose d'un puissant moteur de 1200 W conçu pour battre facilement (69389).
- Protection contre la surchauffe.
- Les lames en acier inoxydable pulvérisent les graines, coupent les peaux et triturent les parties denses et fibreuses des aliments afin de maintenir une quantité de nutriments maximale.
- Fonctionnement très simple, il suffit d'exercer une pression le bol pour que le moteur active les lames (69389).
- Inclut deux bols en tritan sans BPA (69389 - 1 L / 0,5 L) / (69382 - 600 ml / 300 ml), deux couvercles et une poignée qui s'emboîte aux bols pour faciliter leur prise en main (69389).

EN

- High quality blender, effortlessly prepares shakes, creams, and fruit and vegetables juices in seconds.
- Equipped with a powerful 1200 W motor designed for easy blending (69389).
- Overheating protection.
- Stainless steel blades grind seeds, cut skins, and purée dense, fibrous parts of the food to the point of maintaining the maximum amount of nutrients.
- Very easy to operate. Just press the pitcher to activate the blades of the motor (69389).
- Includes two (69389 - 1 L / 0,5 L) / (69382 - 600 ml / 300 ml) BPA free blender pitchers, two lids, and a handle that attaches to the cups for easy handling (69389).

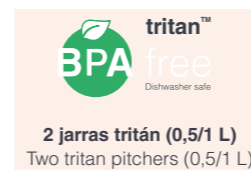

### Batidora personal PRO

Mixeur personnel · Mini-Standmixer  
Individual blender · Batedeira pessoal

Ref	€	W	L	U.Venta
69389	99,90	1200	0,5 / 1,0	1



### Batidora personal MIX & GO

Personnelle mixeur · Personliche mixer  
Personal blender · Misturador pessoal

Ref	€	W	ml	U.Venta
69382	50,00	350	600/300	1

Ref	Tensión/Voltage	Potencia/Power	Jarras/Pitchers	Jarra pequeña Small jug	Jarra grande Big jug	Dimensiones/Sizes	Peso/Weight
69389	220-240 V ; 50/60 Hz	1200 W	2	0,5 L	1,0 L	14x14x40,5 cm	2,40 Kg
69382	220-240 V ; 50/60 Hz	350 W	2	0,3 L	0,6 L	12x12x40,5 cm	1,05 Kg

# MIX & GO

## Batidora personal c/jarra

· Household use ·



### ES

- Ideal para preparar pequeñas cantidades de cremas, batidos y zumos de fruta y verdura al instante.
- Compacta y de gran potencia (350 W), dispone de 4 cuchillas de acero inoxidable especiales para triturar hielo y moler semillas, frutos secos, cereales y café.
- Permite preparar y transportarlo en el mismo recipiente gracias a su jarra-vaso portátil.

### FR

- Idéal pour préparer instantanément de petites quantités de crèmes, milk-shakes et jus de fruits et légumes.
- Compact et d'une grande puissance (350 W), il dispose de 4 lames en acier inoxydable spéciales pour piler la glace et mouliner les graines, les fruits secs, les céréales et le café.
- Permet de préparer et de transporter les préparations dans le même récipient grâce à son pichet/verre portable.

### EN

- Ideal for preparing small quantities of creams, smoothies and fruit and vegetable juices instantly.
- Compact and powerful (350 W), it has 4 special stainless steel blades for crushing ice and grinding seeds, nuts, cereals and coffee.
- Enables you to prepare and transport your juices or smoothies in the same container thanks to its portable.

Jarra de vidrio templado (500 ml)  
High quality toughened glass (500 ml)



Incluye 4 pajitas desechables de papel ecológico  
Includes 4 disposable straws made from eco-friendly paper

### Batidora personal MIX & GO con jarra de cristal

Mixeur personnel MIX & GO avec bol en verre · Mini-Standmixer MIX & GO mit Glasbehälter  
MIX & GO individual blender with glass jug · Batedeira pessoal MIX & GO com jarra de vidro

Ref	€	W	L	U.Venta
69386	46,60	350	0,50	1



Cuchillas de acero inoxidable especiales para triturar hielo y moler semillas, frutos secos, cereales y café  
Special stainless steel blades for crushing ice and grind seeds, nuts, cereals and coffee

Ref	Tensión/Voltage	Potencia/Power	Capacidad/Capacity	Altura jarra/Height jar	Dimensiones/Sizes	Peso/Weight
69386	220-240 V; 50/60 Hz	350 W	500 ml	23 cm	Ø12 x 31 cm	1,50 Kg

## Accesorios · Accessoires · Accessories

Apta para la batidora 69386/69382  
Suitable for blender 69386/69382



Tapa de metal con orificio central para introducir la pajita  
Metal lid with central hole for straw insertion



### Set 2 jarras de cristal

Set de 2 pichets en verre · 2er-Set Glasbehälter  
Set of 2 glass pitchers · Conjunto de 2 jarras de vidrio

Ref	€	ml	U.Venta
69387	19,10	500	1



### Set 4 pajitas + cepillo

Set de pajitas + brosse · 4er-Set Strohhalme mit Reinigungsbürste  
Set of 4 straws + cleaning brush · Conjunto de 4 palhinhas + escova

	Ref	€	Color	Ø (mm)	h (cm)	U.Venta
A	63131	4,90	Inox	6	21,5	1
B	69338	4,60	Inox	6	25,5	1
C	63132	7,30	Copper	6	21,5	1
D	63133	3,00	Cristal · Glass	6	21,5	12

No se deforman ni transmiten ningún sabor  
Muy resistentes  
Biodegradables  
Certificación FDA, apta para el uso alimenticio  
They don't distort or transfer any flavour  
Very resistant  
Biodegradable  
FDA certified, suitable for use with food



### Set 50 pajitas de papelecológicas

Set de 50 pailles en papier écologiques · Papierstrohhalm umweltfreundlich 50-er-Set  
Set of 50 eco-friendly paper straws · Conjunto de 50 palhinhas de papel Ecológicas

Ref	€	Ø (mm)	h (cm)	e (mm)	g/mm2	U.Venta
69339	4,80	6	23	0,3	310	1

- INOX:** Pajitas reutilizables de acero inoxidable de gran calidad. No se oxidan, agrietan, rayan o rompen. La referencia 63132 destaca por su elegante acabado en color cobre. La mejor alternativa a las pajitas de plástico de un solo uso. Ecológicas, respetuosas con el medio ambiente. Incluye cepillo para facilitar la limpieza. Aptas para el lavavajillas.
- CRISTAL:** Fabricadas en cristal borosilicato de máxima calidad, resistente a los golpes. Extremadamente duraderas y seguras de usar. Esquinas redondeadas. Reutilizables, higiénicas y ecológicas. Fácil limpieza. Incluye cepillo. Aptas para el lavavajillas.
- INOX :** Pailles réutilisables en acier inoxydable de haute qualité. Ne rouillent pas, ne se fissurent pas, ne se rayent pas et ne se cassent pas. La référence 63132 se distingue par son élégante finition cuivrée. finition cuivrée. La meilleure alternative aux pailles en plastique à usage unique. Écologique, respectueuse de l'environnement. Brosse incluse pour un nettoyage facile. Passe au lave-vaisselle.
- CRISTAL :** Fabriqué en verre borosilicaté de haute qualité, résistant aux chocs. Extrêmement durable et sûr à utiliser. Coins arrondis. Réutilisable, hygiénique et écologique. Facile à nettoyer. Brosse incluse. Passe au lave-vaisselle.
- INOX:** High quality reusable stainless steel straws. They don't rust, crack, scratch or break. Reference 63132 stand out thanks to their elegant finish in copper color. The ideal alternative to single-use plastic straws. Environmentally friendly. Comes with a brush for easy cleaning. Dishwasher safe.
- GLASS:** Made of high-quality impact-resistant borosilicate glass. Extremely durable and safe to use. Rounded corners. Reusable, hygienic, and ecological. Easy cleaning. Includes brush. Dishwasher-safe.

# BLACK & WHITE

## Batidora profesional

Professional use



ES

- Potencia y resultados profesionales.
- Disfruta del placer de cocinar con la batidora profesional.
- Gracias a su gran rendimiento, potente motor, calidad y durabilidad lograrás resultados extraordinarios.
- La batidora ofrece una gran versatilidad y es ideal para elaborar todo tipo de zumos, batidos, sopas, salsas, patés, granizados, helados etc.
- Incluye un completo recetario con todo tipo de recetas diseñado por Lauri Bengochea ([www.mitallerdebienestar.com](http://www.mitallerdebienestar.com)) en exclusiva para Lacor.

FR

- Performance et résultats professionnels.
- Cuisinez avec plaisir grâce au Blender Professionnel.
- Sa performance, son puissant moteur, sa qualité et durée de vie vous donneront des résultats extraordinaires.
- Le blender offre une grande flexibilité et est idéal pour élaborer tout type de jus, smoothies, soupes, sauces, pâtés, granizado (boissons rafraîchissantes), glaces, etc.
- Il contient un livre de recettes élaboré par Lauri Bengochea ([www.mitallerdebienestar.com](http://www.mitallerdebienestar.com)) en exclusivité pour Lacor.

EN

- Power and Professional Results.
- Enjoy the pleasure of cooking with the Professional Mixer.
- Thanks to its high performance, powerful motor, quality and durability you'll get extraordinary results.
- The mixer is extremely versatile and perfect for making all kinds of juices, shakes, soups, sauces, pâtés, iced drinks, ice cream and more.
- It comes with a complete cookbook with all kinds of recipes designed exclusively for Lacor by Laura Bengochea ([www.mitallerdebienestar.com](http://www.mitallerdebienestar.com)).



Batir, picar y moler  
Blend, chop and grind



### Batidora profesional BLACK

Batteur professionnel · Profi-Mixer  
Professional blender · Batedor profesional

Ref	€	W	L	U.Venta
69195	485,60	1200	2,0	1



### Batidora profesional WHITE

Batteur professionnel · Profi-Mixer  
Professional blender · Batedor profesional

Ref	€	W	L	U.Venta
69295	420,10	1200	1,5	1

Ref	Tensión/Voltage	Potencia/Power	Velocidad/Speed	Capacidad/Capacity	Dimensiones/Sizes	Peso/Weight
69195	220-240 V; 50/60 Hz	1200 W	13.300 - 38.000 r.p.m	2,0 L	28x26x52 cm	5,00 Kg
69295	220-240 V; 50/60 Hz	1200 W	13.000 - 38.000 r.p.m	1,5 L	18x24x42 cm	4,00 Kg

Accesorios · Accessoires · Accessories



Apta para las batidoras 69195 y 69295  
Apt for blenders 69195 and 69295

### Jarra batidora con cuchillas

Pot batteur avec lamestl · Krug mit Messer für Mixer  
Blender jug with blades · Jarra batedora com lâminas

Ref	€	L	U.Venta
R69195N	190,50	2,0	1 Jarra · Jug
R69195B	48,00	2,0	1 Tapa · Lid



Apta para las batidoras 69195 y 69295  
Apt for blenders 69195 and 69295

### Jarra batidora con cuchillas

Pot batteur avec lamestl · Krug mit Messer für Mixer  
Blender jug with blades · Jarra batedora com lâminas

Ref	€	L	U.Venta
R69295A	188,00	1,5	1 Jarra + Tapa · Jug + Lid
R69295D	74,70	-	1 Tapa · Lid



Aísla y reduce el nivel de ruido un 80%. Apta para las batidoras 69195 y 69295.  
Isolé et réduit le niveau de bruit de 80%. Apte pour les mixeurs 69195 et 69295.  
Isolates and reduces the noise level by 80%. Apt for blenders 69195 and 69295.

NOTA  
La carcasa solo es valida si las batidoras llevan la jarra baja (R69295A),  
NUNCA con la jarra alta (R69195N).

REMARQUE  
La carcasse n'est valable que si les mixeurs possèdent un bol bas  
(R69295A), JAMAIS avec un bol haut (R69195N).

NOTE  
The casing is only valid if the blender comes with a lower recipient  
(R69295A), NEVER for a higher recipient (R69195N).



Posibilidad de encastrar.  
Dimensiones del agujero: 25,5 x 26,5 cm.  
Possibilité d'encastrer.  
Dimensions du trou : 25,5 x 26,5 cm.  
Encastrable option.  
Dimensions of the hole: 25,5 x 26,5 cm.



### Carcasa aislante de ruido

Boîtier isolant du bruit · Geräuschdämpfendes Gehäuse  
Noise reducing enclosure · Carcaça isolante do ruído

Ref	€	cm	h (cm)	U.Venta
R69295B	244,10	25x30	46	1

# INOX · WHITE · VITA

## Batidoras

Household use

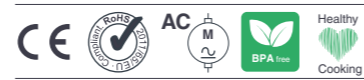

Jarra marcada en mililitros, cups y onzas  
Jug marked in millilitres, cups and ounces



Inox



**Batidora INOX**  
Mélangeur · Mixer  
Blender · Batedor

Ref	€	W	L	U.Venta
69581	156,40	1000	1,50	1

Jarra marcada en mililitros, cups y onzas  
Jug marked in millilitres, cups and ounces

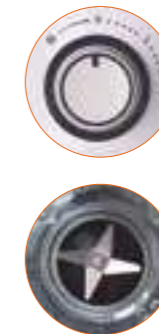

**Batidora WHITE**  
Mélangeur · Mixer  
Blender · Batedor

Ref	€	W	L	U.Venta
69587	80,00	700	1,50	1

Cierre de seguridad  
Safety latch

ES

### 69581 - Batidora INOX

- Ideal para elaborar todo tipo de zumos, batidos, cremas, salsas, granizados, etc.
- Potente motor de 1000 W para licuar, mezclar y triturar de manera rápida y eficaz.
- Control de velocidad variable con display luminoso, seleccione la velocidad deseada con la ruleta.
- Tres funciones pre-establecidas: Pulse · Ice crush · Smoothie.
- \* Velocidad PULSE para batir al gusto a máxima velocidad.
- \* Velocidad ICE CRUSH, función especial para picar hielo.
- Jarra de vidrio borosilicato con escala (ml / cups / oz) de alta calidad resistente a los arañazos de 1,50 L.
- Vaso medidor de 50 ml / 1-3 / 4 oz.
- 6 cuchillas lisas desmontables de acero inoxidable de alta calidad.
- Cuerpo en acero inoxidable.
- Pies antideslizantes, aportan estabilidad a la hora del uso.

FR

### 69581 - Batidora INOX

- Idéal pour préparer tout type de jus, milk-shakes, crèmes, sauces, granités, etc.
- Puissant moteur de 1000 W pour mixer, mélanger et triturer de façon rapide et efficace.
- Contrôle de vitesse variable avec affichage lumineux, sélection de la vitesse souhaitée avec le bouton rotatif.
- Trois fonctions préétablies : Pulse · Ice crush · Smoothie.
- \* Vitesse PULSE pour mixer à sa guise à la vitesse maximum.
- \* Vitesse ICE CRUSH, fonction spéciale pour piler la glace.
- Bol en verre borosilicate avec graduations (ml / cups / oz) de grande qualité résistant aux rayures de 1,50 L.
- Verre doseur de 50 ml / 1-3 / 4 oz.
- 6 lames lisses démontables en acier inoxydable de grande qualité.
- Corps en acier inoxydable. Pieds antidérapants, qui apportent une stabilité lors de l'utilisation.

EN

### 69581 - Batidora INOX

- Ideal for making all types of juices, smoothies, creams, sauces, slushies, etc.
- Powerful 1000 W motor to liquefy, mix, and chop quickly and efficiently.
- Variable speed control with illuminated display, select the desired speed using the selector knob.
- Three pre-set functions, Pulse · Ice Crush · Smoothie.
- \* PULSE speed to blend foods to desired texture at maximum speed.
- \* ICE CRUSH speed, special function for crushing ice.
- High-quality scratch-resistant borosilicate glass pitcher (ml / cups / oz) 1.5 L.
- Measuring cup 50 ml / 1-3/4 oz.
- 6 detachable high quality stainless steel flat blades.
- Stainless steel body. Anti-slip base, provides stability in operation.

### 69587 - Batidora WHITE

- Idéal pour élaborer tous types de jus, smoothies, soupes, sauces, crèmes, granités, etc.
- Puissant moteur de 700 W pour mixer, mélanger et triturer de façon rapide et efficace.
- 2 vitesses + Pulse, sélection de la vitesse souhaitée avec le bouton rotatif.
- Vitesse PULSE pour mixer à la vitesse maximum.
- Bol en verre avec graduation (ml / cups / oz) de grande qualité résistant aux rayures de 1,50 L avec fermeture de sécurité.
- Verre mesureur de 50 ml / 1-3/4 oz.
- 4 lames lisses démontables en acier inoxydable de grande qualité.
- Pieds antidérapants, qui apportent une stabilité lors de l'utilisation.

### 69587 - Batidora WHITE

- Ideal para elaborar todo tipo de zumos, batidos, cremas, salsas, granizados, etc.
- Potente motor de 700 W para licuar, mezclar y triturar de manera rápida y eficaz.
- 2 velocidades + Pulse. Seleccione la velocidad deseada con la ruleta.
- Velocidad PULSE para batir al gusto a máxima velocidad.
- Jarra de cristal con escala (ml / cups / oz) de alta calidad resistente a los arañazos de 1,50 L con cierre de seguridad.
- Vaso medidor de 50 ml / 1-3/4 oz.
- 4 cuchillas lisas desmontables de acero inoxidable de alta calidad.
- Pies antideslizantes, aportan estabilidad a la hora del uso.



Cristal  
Glass

Inox

**Batidor VITA**  
Mixer · Mixer  
Blender · Batedora

Ref	€	W	L	U.Venta
69081	85,40	500	1,5	1

- Función PULSE para batir a su gusto. Mantenga el mando en la posición P para mantener la batidora en marcha.
- Posición 1 para batir a baja revolución, en especial cuando pique hielo o elementos sólidos duros.
- Posición 2 le permite batir a máxima velocidad todo tipo de frutas blandas y líquidos.
- Asegúrese que la batidora esté en la posición 0 antes de extraer y verter el contenido de la jarra.

- Option PULSE pour battre à volonté, maintenez la commande sur la position P pour laissez le batteur en marche.
- Position 1 pour battre à faible révolution, notamment quand vous hachez des glaçons ou des éléments solides durs.
- Position 2 vous permet de battre à vitesse maximale tout type de fruits mous et liquides.
- Assurez-vous que le batteur se trouve en position 0 avant d'extraire et de verser le contenu de la jarra.

- Use the P option to blend as you choose; keep the switch on the P position to keep the blender working.
- 1 position to blend at low speed especially when crushing ice or hard solid items.
- 2 position allows you to blend all types of soft fruits and liquids at maximum speed.
- Ensure the blender is at the 0 position before removing and pouring the contents from the jug.

Ref	Tensión/Voltage	Potencia/Power	Velocidad/Speed	Capacidad/Capacity	Dimensiones/Sizes	Peso/Weight
69081	220-240 V; 50/60 Hz	500 W	10.000 - 12.000 r.p.m.	1,50 L	21x23x40 cm	3,24 Kg



# MÁQUINAS VACÍO

## Colección

Professional use



Inox

### ¿Qué es la cocción al vacío?

#### Beneficios de la cocción a baja temperatura:

Entre las nuevas técnicas de restauración, la más importante es la cocción y conservación al vacío. Las ventajas que ofrece esta técnica aseguran su introducción y adaptación a las necesidades de cada cocina: ganar tiempo, mejora de costes, mejor organización del personal y mayor duración de los productos, manteniendo sus cualidades higiénicas y organolépticas, son algunas de las principales razones que auguran su éxito e introducción en la restauración.

Hablamos de productos sometidos a un proceso de envasado al vacío y expuestos a temperaturas que nunca superan los 100°C. Debido a la diferencia de presión, conseguimos temperaturas de ebullición del agua a baja temperatura y la penetración de temperatura a corazón de producto es lineal, es decir, no encuentra moléculas de aire y no produce una reacción radial, por lo que el tratamiento y los resultados obtenidos con el producto están perfectamente controlados.

La forma más sencilla de explicar la cocción al vacío es decir que en vez de guisar, como es tradicional, los alimentos a 130°C de calor por un periodo relativamente corto, aquí se cuecen entre 65°C y 99°C en tiempos más prolongados según la naturaleza del género y su peso. Es, pues, una cocción larga y a baja temperatura. En un horno convencional, una pieza de carne se cuece a 200°C de temperatura, lo que ocasiona que el exterior se tueste. Sin embargo, la temperatura en el corazón de la pieza rara vez supera los 50°C. Por lo tanto, sólo es necesaria una temperatura igual o ligeramente superior a los 65°C para cocer un alimento, evitando el resecamiento y el endurecimiento de la fibra muscular así como la sobrecoCCIÓN.

### Qu'est-ce que la cuisson sous-vide ?

#### Avantages de la cuisson à basse température :

Parmi les nouvelles techniques de restauration, la plus importante est la cuisson et la conservation sous-vide. Les avantages qu'offre cette technique garantissent son introduction et son adaptation aux besoins de chaque cuisine : gagner du temps, améliorer les coûts, une meilleure organisation du personnel et une plus grande durée de conservation des produits, en maintenant leur qualités hygiéniques et organoleptiques, sont quelques-unes des raisons principales qui expliquent son succès et son introduction dans la restauration.

Nous parlons de produits soumis à un processus de conditionnement sous-vide et exposés à des températures toujours inférieures à 100°C. En raison de la différence de pression, on obtient des températures d'ébullition de l'eau à basse température et la pénétration de la température au cœur du produit est linéaire, c'est-à-dire qu'elle ne rencontre pas de molécules d'air et ne produit aucune réaction radiale, c'est pourquoi le traitement et les résultats obtenus avec le produit sont parfaitement contrôlés.

La façon la plus simple d'expliquer la cuisson sous-vide est de dire qu'au lieu de cuisiner, comme c'est le cas traditionnellement, les aliments à une température de 130°C pendant un laps de temps relativement court, ils sont ici cuits entre 65°C et 99°C pendant un laps de temps plus long selon la nature du genre et le poids. Il s'agit donc d'une cuisson longue et à basse température. Dans un four conventionnel, une pièce de viande est cuite à une température de 200°C, ce qui provoque le brunissage de l'extérieur. Cependant, la température au cœur de la pièce dépasse rarement 50°C. Par conséquent, il suffit d'une température égale ou légèrement supérieure à 65°C pour cuire un aliment, évitant ainsi le dessèchement et le durcissement de la fibre musculaire ainsi que la surcuisson.

### What is Sous Vide?

#### The benefits of low-temperature cooking

Among the new techniques for cooking professionals, the most important one is cooking and storing food in vacuum sealed pouches. The advantages of the technique mean it will be used in and adapted to the needs of every kitchen. Some of the main reasons why it will be successful and widely used in the hospitality industry are the savings in time and money, better staff organisation and being able to store products longer without sacrificing organoleptic qualities or hygiene.

Sous vide refers to products that are vacuum sealed and never exposed to temperatures above 100° C. Because of the difference in pressure, water boils at a low temperature and heat penetrates into the heart of the product in a linear fashion which means there is no interference from air molecules and a radial reaction does not occur so consequently product manipulation and results can be perfectly controlled.

The simplest way to explain sous vide is to say that instead of the traditional method of cooking food at 130°C for a relatively short time food is cooked at 65°C to 99°C for a longer time, depending on the type of product and how much it weighs. It's essentially slow cooking at a low temperature. In a conventional oven, a piece of meat is cooked at 200°C, which makes the outside brown and crispy. However, the temperature in the centre rarely exceeds 50°C. So you can see that meat only needs to be cooked at 65°C or a little hotter, which prevents it from drying out or getting tough as well as over cooking.

### Tabla orientativa · Tableau d'orientation · Guidance table

Almacén Storehouse	25°C +/- 2°C								
Almacenamiento normal Normal storage life									
Sellado al vacío Vacuum sealed life	1-2 semanas 1-2 weeks	3-4 días 3-4 days	2-4 días 2-4 days	1 semana 1 week	5-6 meses 5-6 months				
Frigorífico Fridge	5°C +/- 2°C								
Almacenamiento normal Normal storage life	1-2 semanas 1-2 weeks	1 semana 1 week	1 semana 1 week	3-4 días 3-4 days	2-4 semanas 2-4 weeks	1-2 semanas 1-2 weeks	1-2 semanas 1-2 weeks	1-2 semanas 1-2 weeks	2-3 días 2-3 days
Sellado al vacío Vacuum sealed life	1 mes 1 month	2-4 semanas 2-4 weeks	2-4 semanas 2-4 weeks	2 semanas 2 weeks	1 mes 1 month	1 mes 1 month	6-12 semanas 6-12 weeks	6-12 semanas 6-12 weeks	1 semana 1 week
Congelador Freezer	-18°C +/- 2°C								
Almacenamiento normal Normal storage life	6 meses 6 months	6 meses 6 months	6 meses 6 months	1-2 semanas 1-2 weeks	8 meses 8 months	8 meses 8 months	6-12 semanas 6-12 weeks	4 meses 4 months	
Sellado al vacío Vacuum sealed life	2-3 años 2-3 years	2-3 años 2-3 years	2-3 años 2-3 years	2 años 2 years	2-3 años 2-3 years	2-3 años 2-3 years	6 meses 6 months	1 año 1 year	

608

Altura interior útil 11 cm  
11 cm useful interior height



**Máquina de vacío campana**  
Machine sous vide à cloche · Vakuümiergeräte  
Bell-shaped vacuum machine · Máquina de vacío tipo cámara

Ref	€	W	U.Venta
69116	1709,70	630	1

Ref	Tensión/Voltage	Potencia/Power	Vacío/Vacuum	Caudal bomba/Pump flow	L. sellado/Seal length	A. sellado/Seal width	Dimensiones/Sizes	Peso/Weight
69116	220-240 V; 50 Hz	630 W	0,9 bar	83 L/min	29 cm	4 cm	42x36x36,5 cm 35x30x5 cm (cámara - chamber)	24,5 Kg

Inox



**Máquina de vacío campana**  
Machine sous vide à cloche · Vakuümiergeräte  
Bell-shaped vacuum machine · Máquina de vacío tipo cámara

Ref	€	W	U.Venta
69352	972,30	350	1

Ref	Tensión/Voltage	Potencia/Power	Vacío/Vacuum	Caudal bomba/Pump flow	L. sellado/Seal length	A. sellado/Seal width	Dimensiones/Sizes	Peso/Weight
69352	220-240 V; 50/60 Hz	350 W	0,9 bar	60 L/min	30 cm	2,5 cm	42x38x27 cm 30,5x32,2x8 cm (cámara - chamber)	10 Kg

- Admite la aspiración de líquidos y salsas, sin necesidad de congelarlos antes.
- Envasado por mediación de un COMPRESOR DE AIRE.
- Compresor con pistón, dispone de válvula de entrada y salida de aire.
- Al no ser de aceite no suele precisar mantenimiento alguno.

- Permet l'aspiration de liquides et de sauces, sans avoir à les congeler auparavant.
- Mise sous vide au moyen d'un COMPRESSEUR D'AIR.
- Compresseur avec piston, dispose de valve d'entrée et de sortie d'air.
- Dans la mesure où il n'y a pas d'huile, aucun entretien n'est nécessaire.

- Enables liquids and sauces to be aspirated in the bag with no need to freeze them first.
- U.Ventaaging using an AIR COMPRESSOR.
- Compressor with piston, has an air inlet/outlet valve.
- As it is not oil-based, no maintenance is required.



- Realización de bolsas.
- Admite la aspiración de líquidos y salsas, sin necesidad de congelarlos antes.

- Réalisation de sachets.
- Permet l'aspiration de liquides et de sauces, sans avoir à les congeler auparavant

- Making bags.
- Enables liquids and sauces to be aspirated in the bag with no need to freeze them first.



**Bobina incluida**  
Coil tube included

609

**Accesorios** · Accessoires · Accessories



**Pestañas para colocar en la máquina de vacío PROFESIONAL**  
Eyelashes to place in the PROFESSIONAL vacuum machine



**Compatible para bobinas hasta:**  
Compatible for coils up to:  
69531 - 30 cm / 69541 - 40 cm

**Cuchilla interna deslizante, proporciona un corte limpio y preciso**  
The internal sliding blade makes a clean and precise cut



**SopORTE para rollo**  
Porte-rouleau · Rollenhalter  
Roll holder · Suporte de rolo

Ref	€	L (cm)	U.Venta
69531	24,50	30	1
69541	29,80	40	1



**Grado de protección IP20**  
IP20 degree of protection

**Máquina de vacío PROFESIONAL**

Machine sous vide · Vakuuiergerät  
Vacuum pack machine · Máquina de vacío

Ref	€	W	L (cm)	U.Venta
<b>A</b> 69530	537,50	700	30	1
<b>B</b> 69540	597,30	650	40	1

- Máquina de envasado al vacío profesional, prestaciones de primer nivel.
- Ideal para preparar Sous vide, marinar platos, almacenar distintos alimentos naturales o cocinados, etc.
- Un buen sellado hermético garantiza el sabor, el valor nutricional, la frescura y la protección de los alimentos, aumentando la vida útil entre 2 y 4 veces más.
- Funcionamiento intuitivo y sencillo.
- Doble bomba de vacío muy potente, garantiza un vacío óptimo.
- Ciclo de envasado totalmente automático.
- Función de sellado continuo.
- Función marinado, muy útil para ahorrar tiempo frente a los marinados convencionales.
- Equipada con una barra de sellado extra ancha de 5 mm.
- Carcasa externa de acero inoxidable, robusta e higiénica.
- Gracias a su asa en la tapa el envasado al vacío será más cómodo.
- Bandeja extraíble para pequeñas cantidades de líquidos.
- Incluye 2 pestañas en su parte posterior para adaptar el soporte para rollo (NO incluido).
- Se apoya en cuatro pies de goma para una mayor estabilidad.

- Machine professionnelle d'emballage sous vide, performances de premier ordre.
- Idéale pour préparer Sous vide, faire mariner des plats, stocker différents aliments naturels ou cuisinés, etc.
- Un bon scellage hermétique garantit le goût, la valeur nutritionnelle, la fraîcheur et la protection des aliments, 2 à 4 fois plus de durée de conservation.
- Fonctionnement simple et intuitif.
- Pompe à vide double très puissante, assure un vide optimal.
- Cycle d'emballage entièrement automatique.
- Fonction de scellage continue.
- Fonction marinade, très utile pour gagner du temps par rapport aux marinades conventionnelles.
- Équipée d'une barre de scellage extra large de 5 mm.
- Carcasse externe robuste et hygiénique en acier inoxydable.
- Grâce à sa poignée sur le couvercle, l'emballage sous vide sera plus pratique.
- Plateau pour petites quantités de liquides amovibles.
- Comprend 2 languettes à l'arrière pour adapter le porte-rouleau (NON inclus).
- Quatre pieds en caoutchouc pour une plus grande stabilité.

- Professional vacuum U.Ventaaging machine, top quality features.
- Ideal to prepare Sous vide, marinate dishes, and store different raw or cooked foods, etc.
- A proper airtight seal guarantees the flavour, nutritional value, freshness, and protection of food extending its useful life between 2 and 4 times.
- Intuitive and simple operation.
- Very powerful dual vacuum pump, guarantees optimal vacuum.
- Fully automatic U.Ventaaging cycle.
- Continuous sealing function.
- Marinate function, very useful to save time compared to conventional marinating.
- Equipped with an extra-wide 5mm sealing bar.
- Sturdy and hygienic stainless steel outer housing.
- The lid handle provides improved comfort for vacuum U.Ventaaging.
- Tray for small amounts of extractable liquids.
- Includes 2 tabs on the back to adapt the support for the roll (NOT included).
- Includes four rubber support bases for greater stability.



**Función canister**  
Canister function



**Inox**



**Barra para corte instantáneo**  
**Orificio para la aspiración de los botes**  
Bar for instant cutting  
Opening for the sealing of canisters

**3 niveles de tiempo de sellado (secos, húmedos...)**  
**Doble bomba de vacío muy potente**  
**Función MARINATE y PULSE**  
Three levels of sealing time (dry, wet, etc.)  
Very powerful dual vacuum pump  
MARINATE and PULSE functions

*Semiprofessional use*

**Máquina de vacío EFFICIENT**

Machine sous vide · Vakuuiergerät  
Vacuum pack machine · Máquina de vacío

Ref	€	W	U.Venta
69353	226,20	130	1

Ref	Tensión/Voltage	Potencia/Power	Presión/Pressure	Caudal bomba/Pump flow	L. sellado/Seal length	A. sellado/Seal width	Dimensiones/Sizes	Peso/Weight
69353	220-240 V; 50 Hz	130 W	0,9 bar	20 L/min (2 pump)	30 cm	2 mm (2)	40x19,4x11 cm	2,90 Kg



**Posibilidad de realización de bolsas**  
**Bobina incluida - 22 cm x 3 m**  
**Orificio para la aspiración de los botes**  
Possibility of making bags  
Coil tube included - 22 cm x 3 m  
Opening for the sealing of canisters

**Máquina de vacío MAXI**

Machine sous vide · Vakuuiergerät  
Vacuum pack machine · Máquina de vacío

Ref	€	W	U.Venta
69350	150,80	120	1

Ref	Tensión/Voltage	Potencia/Power	Presión/Pressure	Caudal bomba/Pump flow	L. sellado/Seal length	A. sellado/Seal width	Dimensiones/Sizes	Peso/Weight
69350	220-240 V; 50/60 Hz	120 W	0,6 - 0,8 bar	12 l/min	30 cm	3 mm	43,5x21x10 cm	2,05 Kg

**Incluye 10 bolsas de vacío (20x30 cm)**  
Includes 10 vacuum bags (20x30 cm)

**Incluye 10 bolsas de vacío: 20x30 cm (5) / 28x40 cm (5)**  
Includes 10 vacuum bags: 20x30 cm (5) / 28x40 cm (5)



**Función canister**  
Canister function

**Máquina de vacío HOME**

Machine sous vide · Vakuuiergerät  
Vacuum pack machine · Máquina de vacío

Ref	€	W	U.Venta
69050	108,40	110	1



**Máquina de vacío LUXE**

Machine sous vide · Vakuuiergerät  
Vacuum pack machine · Máquina de vacío

Ref	€	W	U.Venta
69151	122,90	120	1

Ref	Tensión/Voltage	Potencia/Power	Presión/Pressure	Caudal bomba/Pump flow	L. sellado/Seal length	A. sellado/Seal width	Dimensiones/Sizes	Peso/Weight
69530	220-240 V; 50-60 Hz	700 W	0,9 bar	16 L/min (2 pumps)	31 cm	5 mm	39x27,5x13 cm	6,90 Kg
69540	220-240 V; 50-60 Hz	650 W	0,9 bar	16 L/min (2 pumps)	40 cm	5 mm	49x26x12,5 cm	8,50 Kg

Ref	Tensión/Voltage	Potencia/Power	Presión/Pressure	Caudal bomba/Pump flow	L. sellado/Seal length	A. sellado/Seal width	Dimensiones/Sizes	Peso/Weight
69050	220-240 V; 50 Hz	110 W	0,8 bar	9 l/min	28 cm (max)		35,7x14,8x8,7 cm	1,40 Kg
69151	220-240 V; 50 Hz	120 W	0,4 - 0,8 bar	9 l/min	30 cm (max)		37x14,4x7,4 cm	1,55 Kg

## Ultrarrápido / Ultra-fast:



**Reduce 6 pasos en 3**  
Turns 6 steps into 3



**AutoPlace**  
Garantiza la colocación correcta de la bolsa  
Placement correct des sacs garanti  
Ensures bags are inserted correctly



**Accesorio para función canister**  
Accessory for canister function



**Tapa totalmente extraíble**  
Totally removable lid



**Máquina de vacío SMART**  
Machine sous vide · Vakuümiergerät  
Vacuum pack machine · Máquina de vacío

Ref	€	W	U.Venta
69357	104,00	120	1



**Fácil limpieza**  
Easy cleaning



**Máquina de vacío AUTOPRO**  
Machine sous vide · Vakuümiergerät  
Vacuum pack machine · Máquina de vacío

Ref	€	W	U.Venta
69356	96,60	120	1

- Doble bomba de vacío con poder de succión de 5 L/min (69357).
- Doble bomba de vacío con poder de succión de 4,3 L/min (69356).
- Ultra rápido: reduce 6 pasos en 3.
- Potente bomba de vacío de hasta 80kpa que garantiza un nivel de vacío óptimo.
- Sellado 100% automático, tan solo pulsando un botón.
- AutoPlace: garantiza la colocación correcta de la bolsa.
- Garantiza la calidad, frescor y sabor de los alimentos durante mucho más tiempo.
- Diseñada para alimentos crudos y cocinados; pescado, carne, verdura, legumbre, embutido, fruta, frutos secos y cocina a baja temperatura.
- Barra de sellado de bolsa de 30 cm de largo.
- Sellado múltiple: sella varias bolsas simultáneamente.
- Contiene un orificio para la aspiración de los botes.
- Diseño compacto y ligero. Funcionamiento intuitivo y sencillo.
- Tapa extraíble para facilitar la limpieza.
- Incluye: 10 bolsas de vacío (20x30 cm) libres de BPA.

- Double pompe à vide avec une puissance d'aspiration de 5 L/min (69357).
- Double pompe à vide avec une puissance d'aspiration de 4,3 L/min (69356).
- Ultra rapide : réduit 6 étapes en 3.
- Pompe à vide puissante pouvant atteindre 80kpa garantissant un niveau de vide optimal.
- Scellage 100% automatique par simple pression sur un bouton.
- AutoPlace : placement correct des sacs garanti.
- Qualité, fraîcheur et saveur garanties des aliments pendant beaucoup plus longtemps.
- Conçue pour les aliments crus et cuits ; poisson, viande, légumes, légumineuses, saucisses, fruits, fruits secs et cuisson à basse température.
- Barre de scellement de sacs de 30 cm de long.
- Scellage multiple : scelle plusieurs sacs simultanément.
- Contient un trou pour l'aspiration des bocaux.
- Conception compacte et légère. Fonctionnement intuitif et simple.
- Comprend : 10 sacs sous vide (20x30 cm) sans BPA.

- Double vacuum pump with 5 L/min suction power (69357).
- Double vacuum pump with 4,3 L/min suction power (69356).
- Ultra-fast: turns 6 steps into 3.
- Powerful vacuum pump with up to 80 kpa ensures an optimal vacuum.
- 100% automatic sealing with the push of a button.
- AutoPlace: ensures bags are inserted correctly.
- Guarantees the quality, freshness and flavour of food for a lot longer.
- Designed for cooked or raw food: fish, meat, vegetables, legumes, cold cuts, fruit, nuts and low temperature cooking.
- 30 cm long bag sealing bar.
- Multiple sealing: can seal several bags simultaneously.
- It has a hole for doing vacuum in containers.
- Compact and lightweight design Simple and intuitive use.
- Includes: 10 BPA free vacuum bags (20x30 cm).



**Compartimento para líquidos**  
Compartment for liquids



**Orificio para la aspiración de los botes**  
Opening for the sealing of canisters



**Máquina de vacío EXTREME**  
Machine de conditionnement sous vide · Vakuümiergerät  
Vacuum machine · Máquina de vacío

Ref	€	W	U.Venta
69355	146,30	110	1

Ref	Tensión/Voltage	Potencia/Power	Presión/Pressure	Cap. bomba/Pump Cap.	L. Sellado/Seal	Dimensiones/Sizes	Peso/Weight
69355	220-240 V; 50 Hz	110 W	0,8 bar	12 L/min	30 cm (W=2,5 mm)	42x9,5x15 cm	1,70 Kg



**Tres funciones; sellado de bolsa, función automática y función manual**  
Three functions; bag sealing, automatic function and manual function

**Orificio para la aspiración de los botes**  
Opening for the sealing of canisters



**Máquina de vacío SLIM**  
Machine sous vide · Vakuümiergerät  
Vacuum Upackmachine · Máquina de vacío

Ref	€	W	U.Venta
69354	80,30	80	1

Ref	Tensión/Voltage	Potencia/Power	Presión/Pressure	Caudal bomba/Pump flow	L. sellado/Seal length	A. sellado/Seal width	Dimensiones/Sizes	Peso/Weight
69354	220-240 V; 50 Hz	80 W	0,5 bar	4 L/min (1 pump)	30 cm	2 mm	38,4x9,7x5,7 cm	1,00 Kg

- Sella herméticamente los alimentos aumentando de 3 a 5 veces más su durabilidad.
- Expulsa el aire y la humedad, manteniendo sus sabores y nutrientes.
- Panel de control táctil, 2 niveles de envasado al vacío: alimentos húmedos y secos.
- Bandeja para recoger líquidos en la parte posterior de la máquina.
- Gracias a su diseño vertical ocupa poco espacio.

- Scellage hermétique des aliments, augmentant ainsi de 3 à 5 fois leur durabilité.
- Expulse l'air et l'humidité, en conservant leurs saveurs et leurs nutriments.
- Tableau de contrôle tactile, 2 niveaux de conditionnement sous vide : aliments humides et aliments secs.
- Plateau pour recueillir les liquides dans la partie arrière de la machine.
- Prend moins de place grâce à sa conception verticale.

- Hermetically seals the food, increasing its shelf life by 3 to 5 times.
- Expels air and moisture, maintaining the food's flavours and nutrients.
- Touch control panel, 2 levels of vacuum packaging: moist and dry foods.
- Liquid collection tray on the back of the machine.
- Takes up little space thanks to its vertical design.

**Incluye:**  
5 bolsas de 20x30cm / Bobina de 20cmx2m  
Tubo canister de 40 cm de largo  
Includes: 5 20x30cm bags / 20cmx2m coil tube  
40 cm-long canister hose

- Envasadora al vacío doméstica y compacta, perfecta para uso diario.
- Ideal para el almacenamiento de alimentos a largo plazo, aumentando la vida útil entre 2 y 4 veces más y conservando el sabor, el valor nutricional y la frescura. Perfecta para alimentos crudos y cocinados.
- Funcionamiento intuitivo y sencillo.
- Tres funciones disponibles:
  - \* Función de sellado de bolsa.
  - \* Función automática, perfecta para conservar alimentos secos y duros (semillas, granos de café, frutos secos, pasta, hortalizas duras, etc.).
  - \* Función manual, cuando queremos conservar alimentos frágiles como pescados, frutas, champiñones, pan, bizcochos, etc.
- Contiene un orificio para la aspiración de los botes.

- Scelleuse sous-vide domestique et compacte, parfaite pour une utilisation quotidienne.
- Idéal pour conserver des aliments à long terme, augmente de 2 à 4 fois leur vie utile tout en conservant leur goût, la valeur nutritionnelle et la fraîcheur. Parfaite pour des aliments crus et cuisinés.
- Fonctionnement intuitif et simple.
- Fonctions possibles :
  - \* Fonction de soudure de sachet.
  - \* Fonction automatique, parfait e pour conserver les aliments secs et durs (graines, grains de café, fruits secs, pâtes, légumes, etc...).
  - \* Fonction manuelle, pour garder des aliments plus fragiles comme le poisson, les fruits, des champignons, du pains, des biscuits etc.
- Avec orifice pour aspirer les pots.

- Compact vacuum packing machine, perfect for daily home use.
- Ideal for long-term storage of food, making shelf-life to about 2 to 4 times more while preserving the flavour, nutritional value and freshness. Perfect for raw and cooked foods.
- Intuitive and simple operation.
- There are three functions available:
  - \* Bag sealing function.
  - \* Automatic, ideal function for preserving dry and hard foods (seeds, coffee beans, nuts, pasta, hard vegetables, etc.).
  - \* Manual function, for preserving fragile food like fish, fruits, mushrooms, bread, biscuits... etc.
- A hole for drawing out air from canisters.

# VACÍO

## Boninas · Bolsas · Botes

Professional use



ES

- Apto para uso alimenticio.
- Recomendada para uso con máquina de vacío de la marca LACOR.
- No se recomienda su reutilización tras el uso con carnes, pescados y otros alimentos deteriorables, tan solo tras el uso en productos secos, legumbres, frutos secos, etc.

FR

- Adaptée au conditionnement de denrées alimentaires.
- Recommandée pour être utilisée avec la machine à emballer sous vide LACOR.
- Son utilisation est déconseillée pour reconditionner de la viande, du poisson et d'autres denrées alimentaires périssables. Elle peut être réutilisée pour reconditionner des fruits secs, des légumes, des fruits secs, etc.

EN

- Suitable for use with food.
- Recommended for use with vacuum Packer of the LACOR brand.
- Not recommended to be reused after use with meats, fish and other fresh foods, only after use with dried products, pulses, nuts, etc.



### Bobina tubo vacío

Bobine de tube · Vakuumbbeutel Rollen  
Coil tube · Bobina manga

Ref	€	Bobina	Micras	U.Venta
69052	14,10	28cmx5m 22cmx5m	105	1
69057	9,60	14cmx10m	105	6
69059	13,20	22cmx10m	105	1
69058	17,20	28cmx10m	105	1
69451	19,40	40cmx10m	105	1
69259	8,90	28cmx5m	105	1
69458	11,40	28cmx5m	90	1
69459	9,10	22cmx5m	90	6
69462	9,70	28cmx5m 22cmx5m	105	1
69463	8,60	22cmx10m	105	1
69464	10,80	28cmx10m	106	1

Lisas  
Flat



### Bolsas vacío

Sacs de conservation sous vide · Vakuumbbeutel, 100 Stueck  
Vacuum bags · Sacos de vacío

Ref	€	Bolsa	Unidades	Micras	U.Venta
69053	5,10	16x20	25	105	6
69054	8,70	20x30	25	105	6
69055	11,70	24x36	25	105	1
69056	14,70	28x40	25	105	1
69042	32,20	20x30	100	105	1
69046	47,00	25x35	100	105	1
69047	64,00	30x40	100	105	1
69048	128,50	40x60	100	105	1
69453	6,00	16x20	25	90	6
69454	11,00	20x30	25	90	1
69455	15,40	24x36	25	90	1
69460	5,60	20x30	25	105	1
69461	10,10	28x40	25	105	1

Lisas  
Flat



Ideal para embutidos  
Ideal for sausages



### Bobina tubo vacío

Bobine de tube · Vakuumbbeutel Rollen  
Coil tube · Bobina manga

Ref	€	Bobina	Micras	U.Venta
69452	6,00	12cmx10m	105	6

SAN Plastic  
Contenedor  
Container

PP Polypropilene  
Tapa / Lid



### Set 3 botes vacío hogar + adaptador

3 boîte sous vide + Adaptateur · 3 Vakuumb-Behälter-Set + Adapter  
3 Shape canister set + Adapter · Conj. 3 caixas vácuo domésticas + Adaptador

Ref	€	L	U.Venta
69051	36,30	0,7-1,4-2,0	1

Máquina de vacío / Vacuum Pack machine

Ref	€	Bobina	Micras	U.Venta	69354	69355	69356	69357	69151	69050	69350	69353	69540	69530	69352	69116	
69052	14,10	28cmx5m 22cmx5m	105	1	✓	✓	✓	✓	✓	✓	✓	✓	✓	✓	✓	✓	✓
69057	9,60	14cmx10m	105	6	✓	✓	✓	✓	✓	✓	✓	✓	✓	✓	✓	✓	✓
69059	13,20	22cmx10m	105	1	✓	✓	✓	✓	✓	✓	✓	✓	✓	✓	✓	✓	✓
69058	17,20	28cmx10m	105	1	✓	✓	✓	✓	✓	✓	✓	✓	✓	✓	✓	✓	✓
69451	19,40	40cmx10m	105	1	✓	✓	✓	✓	✓	✓	✓	✓	✓	✓	✓	✓	✓
69259	8,90	28cmx5m	105	1	✓	✓	✓	✓	✓	✓	✓	✓	✓	✓	✓	✓	✓
69458	11,40	28cmx5m	90	1	✓	✓	✓	✓	✓	✓	✓	✓	✓	✓	✓	✓	✓
69459	9,10	22cmx5m	90	6	✓	✓	✓	✓	✓	✓	✓	✓	✓	✓	✓	✓	✓
69462	9,70	28cmx5m 22cmx5m	105	1	✓	✓	✓	✓	✓	✓	✓	✓	✓	✓	✓	✓	✓
69463	8,60	22cmx10m	105	1	✓	✓	✓	✓	✓	✓	✓	✓	✓	✓	✓	✓	✓
69464	10,80	28cmx10m	106	1	✓	✓	✓	✓	✓	✓	✓	✓	✓	✓	✓	✓	✓
69053	5,10	16x20	25	6	✓	✓	✓	✓	✓	✓	✓	✓	✓	✓	✓	✓	✓
69054	8,70	20x30	25	6	✓	✓	✓	✓	✓	✓	✓	✓	✓	✓	✓	✓	✓
69055	11,70	24x36	25	1	✓	✓	✓	✓	✓	✓	✓	✓	✓	✓	✓	✓	✓
69056	14,70	28x40	25	1	✓	✓	✓	✓	✓	✓	✓	✓	✓	✓	✓	✓	✓
69042	32,20	20x30	100	1	✓	✓	✓	✓	✓	✓	✓	✓	✓	✓	✓	✓	✓
69046	47,00	25x35	100	1	✓	✓	✓	✓	✓	✓	✓	✓	✓	✓	✓	✓	✓
69047	64,00	30x40	100	1	✓	✓	✓	✓	✓	✓	✓	✓	✓	✓	✓	✓	✓
69048	128,50	40x60	100	1	✓	✓	✓	✓	✓	✓	✓	✓	✓	✓	✓	✓	✓
69453	6,00	16x20	25	6	✓	✓	✓	✓	✓	✓	✓	✓	✓	✓	✓	✓	✓
69454	11,00	20x30	25	1	✓	✓	✓	✓	✓	✓	✓	✓	✓	✓	✓	✓	✓
69455	15,40	24x36	25	1	✓	✓	✓	✓	✓	✓	✓	✓	✓	✓	✓	✓	✓
69460	5,60	20x30	25	1	✓	✓	✓	✓	✓	✓	✓	✓	✓	✓	✓	✓	✓
69461	10,10	28x40	25	1	✓	✓	✓	✓	✓	✓	✓	✓	✓	✓	✓	✓	✓
69048(*)		40x60			✓	✓	✓	✓	✓	✓	✓	✓	✓	✓	✓	✓	✓
69452		12cmx10m			✓	✓	✓	✓	✓	✓	✓	✓	✓	✓	✓	✓	✓
69051		0,7 - 1,4 2, 0 L			✓	✓	✓	✓	✓	✓	✓	✓	✓	✓	✓	✓	✓

ROLLO · COIL TUBE

BOLSAS · BAGS

BOBINA EMBUTIDOS  
COIL TUBE FOR SAUSAGES

SET 3 BOTES VACÍO  
3 SHAPE CANISTER SET

(\*) Apta para la máquina de vacío 69040 (descatalogada)

■ Bolsas y rollos para uso exclusivo del SOUS VIDE

# SOUS VIDE

## Colección

Household use



ES

- Técnica culinaria que prima la calidad del producto.
- Resultados sorprendentes; alimentos más jugosos, tiernos y succulentos.
- Preserva las cualidades del producto y realza su sabor y textura.

FR

- Technique culinaire qui privilégie la qualité du produit.
- Résultats surprenants ; aliments plus juteux, tendres et succulents.
- Préserve les qualités du produit et améliore sa saveur et sa texture.

EN

- Culinary technique that enhances the quality of the product.
- Amazing results; juicier, more tender and more succulent food.
- Preserves the qualities of the product and enhances its flavour and texture.



### Cocinando paso a paso...



**Sazonamos los alimentos a cocinar**  
Assaisonner les aliments à cuisiner  
Season the ingredients for cooking



**Envasamos al vacío los alimentos**  
Conditionner les aliments sous vide  
Vacuum Pack the ingredients



**Llenamos una olla con agua**  
Remplir une marmite d'eau  
Fill a cooking pot with water



**Programamos el tiempo y la temperatura**  
Programmer la durée et la température  
Programme in the time and the temperature



**Esperamos a que emita un pitido**  
Attendre l'émission d'un signal sonore  
Wait for the beep



**Introducimos la bolsa dentro de la olla**  
Introduire le sachet dans la marmite  
Place the bag into the pot



**Retiramos la bolsa y ¡A disfrutar!**  
Retirer le sachet et, bonne dégustation!  
Appetit!  
Remove the bag and... Enjoy!

SOUS VIDE	CIRCULACIÓN CIRCULATION	CAUDAL BOMBA PUMP FLOW	VOLUMEN (máx) VOLUME (max)	POTENCIA POWER	TEMPERATURA TEMPERATURE	DESVIACIÓN DESVIATION	ALT. MIN. DE AGUA MIN. WATER HEIGHT
69192	BOMBA PUMP	6 L/min	40 L	1500 W	5°C - 99°C	0,1°C	12 cm
69304	BOMBA PUMP	4,5 L/min	30 L	1200 W	5°C - 99°C	0,1°C	11 cm
69302 - 69303	EJE VENTILADOR FAN SHAFT	N/A	15 L	1200 W	20°C - 90°C	1°C	6 cm

#### Características de nuestros SOUS VIDE portátiles:

**Resistencia de calentamiento:** Elemento encargado de calentar el agua. Cuanto mayor es la potencia de la resistencia, mayor es la capacidad de calentamiento del agua y menor el tiempo de espera hasta alcanzar la temperatura programable.

**Estabilidad de la temperatura:** Cuanto mayor sea la capacidad de la bomba (L/min), mayor será la estabilidad de la temperatura en el recipiente.

**Resolución:** Escalado de la temperatura a la que se puede programar el agua.

**Desviación de la temperatura:** La máxima diferencia entre temperatura programada y la temperatura del agua.

**Grado de protección contra el agua:** Grado de protección IPX7 frente a inmersiones temporales en agua. Esto garantiza que el aparato acepta la inmersión a 1 metro de profundidad durante 30 minutos sin que sea un peligro ni para el propio artículo ni para el usuario.

#### Caractéristiques de nos SOUS VIDE portables :

**Résistance de chauffe :** Élément chargé de chauffer l'eau. Plus la puissance de la résistance est importante, plus la capacité de chauffe de l'eau est grande et moins le temps d'attente pour atteindre la température programmable est long.

**Stabilité de la température :** Plus la capacité de la pompe est grande (L/min), plus la stabilité de la température dans le récipient sera importante.

**Résolution :** Progression de la température à laquelle peut être programmée l'eau.

**Écart de la température :** La différence maximale entre la température programmée et la température de l'eau.

**Degré de résistance à l'eau :** Degré de protection IPX7 face à des immersions temporaires dans l'eau. Cela garantit que l'appareil est étanche à 1 mètre de profondeur pendant 30 minutes sans que cela ne représente un danger ni pour l'appareil ni pour l'utilisateur.

#### Merkmale unserer tragbaren Vakuumgarer:

**Heizwiderstand:** Erhitzt das Wasser. Je größer die Widerstandsleistung desto größer ist die Heizkapazität und desto kürzer die Wartezeit, bis die voreingestellte Temperatur erreicht wird.

**Temperaturkonstanz:** Je größer die Pumpenkapazität (l/min) desto höher ist die Temperaturkonstanz im Behälter.

**Skalierung:** Temperaturskala für die mögliche Voreinstellung der Wassertemperatur.

**Temperaturabweichung:** Die maximale Differenz zwischen voreingestellter Temperatur und Wassertemperatur.

**Wasserschutzklasse:** Schutzklasse IPX7 gegen Eindringen von Wasser beim kompletten Eintauchen für begrenzte Zeit. D. h. das Gerät lässt sich sicher für 30 Minuten 1 Meter tief eintauchen, ohne dass dadurch für den Anwender oder das Gerät eine Gefahr besteht.

#### Characteristics of our portable SOUS VIDE:

**Heating element:** Component that heats the water The greater the power of the heating element the greater capacity it has for heating water and the less time you have to wait for the water to reach the programmable temperature.

**Temperature stability:** The greater the capacity of the pump (L/m) the better the temperature stability in the container.

**Resolution:** Scale of the temperatures the water can be programmed to.

**Temperature variation:** The maximum difference between the programmed temperature and the water temperature.

**Level of waterproofing protection:** IPX7 level protection against temporary immersion in water. This guarantees that the device can withstand being immersed 1 metre deep for 30 minutes with no risk to the device or the user.

#### Características dos nossos SOUS VIDE portáteis:

**Resistência de aquecimento:** Elemento destinado a aquecer a água. Quando maior for a potência da resistência, maior a capacidade de aquecimento da água, e menor o tempo de espera até alcançar a temperatura programável.

**Estabilidade da temperatura:** Quando maior for a capacidade da bomba (litros/min), maior a estabilidade da temperatura no recipiente.

**Resolução:** Escala de temperatura segundo a qual se pode programar a temperatura da água.

**Desvio da temperatura:** Diferença máxima entre a temperatura programada e a temperatura da água.

**Grado de proteção contra a água:** Grado de proteção IPX7 contra a imersão temporária em água, que garante que o aparelho suporta a imersão a 1 metro de profundidade durante 30 minutos sem que tal represente qualquer perigo para o aparelho ou para o utilizador.



Protection Against Temporary immersion



### Sous Vide PRO

Sous Vide · Sous Vide  
Sous Vide · Sous Vide

Ref	€	W	U.Venta
69192	467,10	1500	1

Nutrientes 100 % Nutrient



Professional use



La circulación mejora y garantiza una distribución uniforme del agua y la estabilidad de la temperatura  
Anclaje sencillo y fácilmente almacenable y transportable. Se sujeta a cualquier tipo de olla, cazuela o cubeta que pueda contener 40 L

Circulation improves and ensures uniform water distribution and temperature stability  
Simple fastening and easy to store and transport. It is attached to any type of pot, saucepan or tray that can contain 40 L

Rejilla divisoria de bolsas vacío  
Grifo de vaciado  
Borde silicona para cierre hermético (TAPA)  
Split grill for separating bags  
Drainage tap  
Silicone edge for hermetic closure (LID)

Nutrientes 100 % Nutrient



Professional use

- Cocina alimentos envasados al vacío a baja temperatura.
- Alimentos más tiernos, sabrosos y con la mejor textura.
- Resultados de alta calidad.
- Carcasa robusta fabricada íntegramente en acero inoxidable.
- Cierre hermético gracias a la tapa con borde de silicona.
- Incluye rejilla divisoria para la separación de las bolsas.
- Pantalla digital de tiempo y temperatura.
- Termostato de gran precisión ajustable: 30°C - 95°C (0,1 °C).
- Temporizador ajustable: 99 horas. 6 memorias. Capacidad: 17 litros.
- Filtro de seguridad para evitar impurezas en el sistema de recirculación del agua.
- Incorpora grifo de vaciado.

- Cuisine des aliments emballés sous vide à basse température.
- Des aliments plus tendres, plus savoureux et avec la meilleure texture.
- Résultats de haute qualité.
- Boîtier robuste entièrement fabriqué en acier inoxydable.
- Fermeture hermétique grâce au couvercle avec des bords en silicone.
- Inclut une grille de séparation des sacs.
- Écran numérique pour afficher le temps et la température.
- Thermostat réglable de haute précision : 30°C - 95°C (0,1 °C).
- Minuterie réglable : 99 heures. 6 mémoires. Capacité : 17 litres.
- Filtre de sécurité pour éviter les impuretés dans le système de recirculation de l'eau.
- Incorpore un robinet de vidange.

- Cooks vacuum packaged food at a low temperature.
- More tender, flavourful food with a better texture.
- High quality results.
- The robust body is made entirely of stainless steel.
- The lid with a silicone edge provides a hermetic closure.
- Split grill for separating bags included.
- Digital time and temperature screen.
- High precision adjustable thermostat: 30°C - 95°C (0.1 °C).
- Adjustable timer: 99 hours. 6 memories. Capacity: 17 litres.
- Safety filter for preventing contamination of the water recirculation system.
- Built in drainage tap.



Protection Against Temporary immersion

Nutrientes 100 % Nutrient



### Sous Vide PRECISE

Sous Vide · Sous Vide  
Sous Vide · Sous Vide

Ref	€	W	U.Venta
69304	310,50	1200	1

Semiprofessional use



La circulación mejora y garantiza una distribución uniforme del agua y la estabilidad de la temperatura  
Anclaje sencillo y fácilmente almacenable y transportable. Se sujeta a cualquier tipo de olla, cazuela o cubeta que pueda contener 30 L

Circulation improves and ensures uniform water distribution and temperature stability  
Simple fastening and easy to store and transport. It is attached to any type of pot, saucepan or tray that can contain 30 L

### Cocedor Sous Vide

Cuiseur Sous Vide · Sous-Vide-Kochapparat  
Sous Vide cooker · Máquina de cozinhar a vácuua Sous Vide

Ref	€	W	L	U.Venta
69492	710,30	1600	17	1

Ref	Tensión/Voltage	Potencia/Power	Caudal bomba/Pump flow	Temperat./Temp.	Precisión/Precision	Capacidad/Cap.	Dimensiones/Sizes	Peso/Weight
69492	220-240 V; 50/60 Hz	1600 W	4 L/min	30°C - 95°C	0,1°C	17 L	62,5x36x30 cm	12 Kg

Pantalla táctil: tiempo, temperatura, inicio y stop  
Touch screen: time, temperature, start and stop

Nutrientes 100 % Nutrient



Semiprofessional use

- Se emplean bolsas herméticas que se sumergen en el agua caliente por debajo del punto de ebullición.
- Pantalla táctil: tiempo, temperatura, inicio y stop.

- Des sachets hermétiques sont utilisés pour immerger les aliments dans l'eau chaude en-deçà du point d'ébullition, soit environ.
- Écran tactile : heure, température, start et stop.

- Uses hermetically sealed bags that are submerged into hot water below boiling point.
- Touch screen: time, temperature, start and stop.



### Sous Vide con tapa

Sous Vide avec couvercle · Sous Vide mit Deckel  
Sous Vide with lid · Sous Vide com tampa

Ref	€	W	L	U.Venta
69193	728,70	620	11 - 12,5	1

Ref	Tensión/Voltage	Potencia/Power	Caudal bomba/Pump flow	Temperat./Temp.	Precisión/Precision	Capacidad/Cap.	Dimensiones/Sizes	Peso/Weight
69193	220-240 V; 50/60 Hz	620 W	6 L/min	5 - 99°C	0,1°C	11 -12,5 L	27x29x42 cm	6,30 Kg



Protection Against Temporary immersion

Nutrientes 100 % Nutrient



### Sous Vide GOURMET

Sous Vide · Sous Vide  
Sous Vide · Sous Vide

Ref	€	W	U.Venta
A 69302	205,20	1200	1
B 69303	205,20	1200	1

Household use



La circulación mejora y garantiza una distribución uniforme del agua y la estabilidad de la temperatura  
Anclaje sencillo y fácilmente almacenable y transportable. Se sujeta a cualquier tipo de olla, cazuela o cubeta que pueda contener 15 L

Circulation improves and ensures uniform water distribution and temperature stability  
Simple fastening and easy to store and transport. It is attached to any type of pot, saucepan or tray that can contain 15 L

Ref	Tensión/Voltage	Potencia/Power	Temperature/Temp.	Capacidad/Capacity	Dimensiones/Sizes	Peso/Weight
69302	220-240 V; 50/60 Hz	1200 W	20-90°C (0,5°C)	15 L	Ø10x37 cm	1,0 Kg
69303	220-240 V; 50/60 Hz	1200 W	20-90°C (0,5°C)	15 L	Ø10x37 cm	1,0 Kg

# SOUS VIDE

## Bolas aislamiento

Professional use

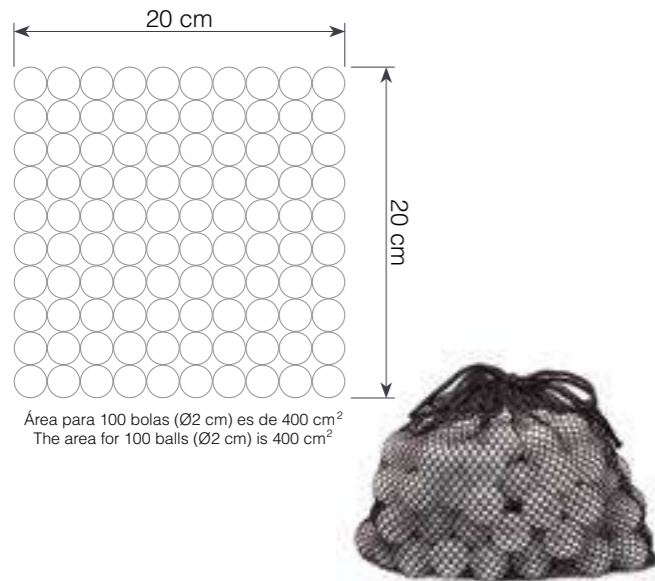

- Bolas aislantes huecas y flotantes de polipropileno (PP), libres de BPA, para dispositivos sous-vide.
- Crean una capa de aislamiento evitando la pérdida de calor en un 75% y en un 90% la evaporación del agua.
- Permiten hervir agua durante horas sin tener que echar más, gracias al mínimo contacto entre agua y aire.
- Aumentan la precisión de la temperatura y ayudan a mantener los envasados al vacío bajo el agua.
- Reducen humos y riesgos de salpicaduras.
- Soportan hasta 150°C sin ningún problema.
- Compatibles con recipientes de todas las formas y tamaños.
- Se presenta con una práctica malla con cierre de cordón.

- Hollow, floating, BPA-free polypropylene (PP) insulation balls for sous-vidé devices.
- Create an insulation layer reducing heat loss by 75% and water evaporation by 90%.
- Enable you to boil water for hours without having to add more, thanks to the minimal contact between water and air.
- Increase temperature accuracy and help keep vacuum packs submerged.
- Reduce smoke and the risk of splashes.
- Withstand up to 150°C without any problem.
- Compatible with containers of all shapes and sizes.
- Come with a handy mesh drawstring bag.

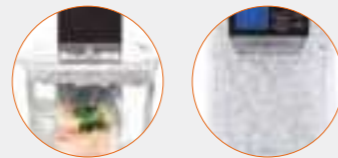

Perfecta capa de aislamiento  
Perfect insulation layer

### Bolas aislantes para Sous Vide

Billes isolantes p/appareils de conditionnement Sous-Vide · Isolationskugeln  
Sous Vide Insulation Balls · Esferas aislantes para Sous Vide

Ref	€	Ø (cm)	Unidad	U.Venta
69219	28,20	2,0	100	1

# SOUS VIDE

## Rejilla

Professional use

Inox  
18/10



4  
Bolsas  
Bags

- Su diseño es ideal para la sujeción en vertical de 4 bolsas de vacío.
- Evita que las bolsas floten y entren en contacto con las paredes o fondo de las cubetas.
- Permite la circulación del agua entre las bolsas en todo momento, consiguiendo una cocción uniforme.
- Agiliza introducir y retirar las bolsas con facilidad.

- Sa forme est idéale pour faire tenir à la verticale 4 sachets pour sous vide.
- Évite que les sachets flottent et entrent en contact avec les parois ou le fond des cuves.
- Permet la circulation constante de l'eau entre les sachets, obtenant ainsi une cuisson uniforme.
- Permet d'introduire et de retirer les sachets plus facilement et rapidement.

- Its design is ideal for holding 4 vacuum bags vertically.
- Prevents bags from floating and coming into contact with the sides or bottom of the container.
- Enables water to flow between the bags at all times, resulting in even cooking.
- Makes it quicker and easier to insert and remove the bags.



### Rack para Sous Vide

Rack pour Sous Vide · Rack für Sous Vide  
Rack for sous vide · Cremalheira para sous Vide

Ref	€	cm	Ø Varilla (mm)	U.Venta
67051	16,10	20x13,5x13,5	4	1

# SACACORCHOS

## Colección

Semiprofessional use



ES

- Diseño elegante, moderno y ergonómico: ideal para su uso profesional y de hogar.
- Funcionamiento rápido y sencillo tan solo pulsando un botón.
- Facilita la extracción del corcho de cualquier botella de vino en tan solo 6-8 segundos.
- Extrae el corcho suavemente y de forma silenciosa.
- Cabezal de extracción con iluminación led (63056 / 63057).
- Indicador de batería luminoso mediante LED: 4 niveles para indicar el nivel de energía (63056).
- Se carga mediante cable Micro USB.
- Incluye: cable cargador USB y descapsulador.

FR

- Style élégant, moderne et ergonomique : idéal pour une utilisation aussi bien professionnelle que domestique.
- Fonctionnement rapide et simple en appuyant simplement sur un bouton.
- Facilite l'extraction du bouchon en liège de n'importe quelle bouteille de vin en 6-8 secondes seulement.
- Extraie le bouchon en liège lentement et silencieusement.
- Tête d'extraction avec éclairage led (63056 / 63057).
- Indicateur de batterie lumineux via LED : 4 niveaux pour indiquer le niveau de batterie (63056).
- Se charge à l'aide d'un câble Micro USB.
- Inclut : câble chargeur USB et décapsuleur.

EN

- Smart, modern and ergonomic design - ideal for professional and home use.
- Quick and easy push-button operation.
- Removes the cork from any bottle of wine in just 6-8 seconds.
- Removes the cork gently and quietly.
- Extraction head with led lighting (63056 / 63057).
- Battery indicator led: 4 energy level indicators (63056).
- Charging by Micro USB cable.
- Included: USB charger and decapsulator.



Autonomía  
Battery life  
**30-40**  
Botellas  
Bottles



### Sacacorchos BLACK LUXE

Tire-bouchon · Korkenzieher  
Corkscrew · Saca-rolhas

Ref	€	Ø (cm)	h (cm)	U.Venta
63056	38,30	4,8	22	1



Autonomía  
Battery life  
**30-40**  
Botellas  
Bottles



### Sacacorchos BLACK

Tire-bouchon · Korkenzieher  
Corkscrew · Saca-rolhas

Ref	€	Ø (cm)	h (cm)	U.Venta
63057	29,60	5	19	1



Autonomía  
Battery life  
**30**  
Botellas  
Bottles



### Sacacorchos eléctrico AutoPro

Tire bouchon électrique · Korkenzieher, elektrisch  
Electric corkscrew · Saca-rolhas Eléctrico

Ref	€	W	cm	U.Venta
63031	40,70	1,2	Ø12x32	1



Autonomía  
Battery life  
**30-40**  
Botellas  
Bottles



### Sacacorchos eléctrico SMART

Tire bouchon électrique · Korkenzieher, elektrisch  
Electric corkscrew · Saca-rolhas Eléctrico

Ref	€	W	cm	U.Venta
63054	43,70	18	Ø5x25	1

# TERMOELÉCTRICOS

## Armarios refrigeradores

· Semiprofessional use ·

CE



ES

- Diseñados para refrigerar eficazmente botellas de vino y otras bebidas.
- La temperatura interior puede ser ajustada mediante el control electrónico.
- Puerta con cámara de cristal templado y sistema de apertura con tirador.
- Estantes extraíbles.
- Silencioso y sistema antivibratorio.
- Pies regulables en altura.
- **NOTA:** deje suficiente espacio en la parte trasera (mínimo 5 cm) para permitir la salida del calor y una adecuada ventilación.
- Vinoteca termoeléctrica: el control y regulación de la temperatura dependerá de la temperatura ambiental del establecimiento.

FR

- Conçue pour refroidir efficacement les bouteilles de vin et autre boissons.
- La température intérieure peut être réglée à l'aide du contrôle électronique.
- Porte en verre trempé et système d'ouverture avec poignée.
- Étagères extractibles.
- Silencieuse et système anti-vibrations.
- Pieds réglables en hauteur.
- REMARQUE : laissez suffisamment d'espace dans la partie arrière (minimum 5 cm) pour permettre la sortie de la chaleur et une bonne ventilation.
- **Cave à vin thermoélectrique :** le contrôle et le réglage de la température dépendront de la température ambiante de l'établissement.

EN

- Designed to effectively cool bottles of wine and other beverages.
- The internal temperature can be adjusted using the electronic control.
- Door with tempered glass chamber and handle-operated opening system.
- Pull-out shelves.
- Silent, anti-vibration system.
- Height-adjustable legs.
- NOTE: leave enough space at the back (minimum 5 cm) to allow heat to escape and adequate ventilation.
- **Thermoelectric wine cooler:** the temperature control and regulation depends on the ambient temperature of the location.

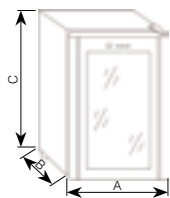

### Armarios refrigeradores

Refridisseur à vin · Thermo Weinkühler  
Thermo wine cooler · Armário refrigerador

Ref	€	W	Botellas	U.Venta
A 69670	385,60	70	8	1
B 69671	413,90	70	12	1
C 69672	459,50	70	18	1
D 69673	516,30	70	28	1

Ref	Tensión/Voltage	Botellas/Bottles	Potencia/Power	Capacidad/Cap.	Temperature/Temp.	Consumo/Consump.	Dimensiones/Sizes A x B x C	Peso/Weight
69670	220-240 V; 50 Hz	8	70 W	23 L	11 - 18°C	190 kWh/annum	26x49,5x48 cm	10,0 Kg
69671	220-240 V; 50 Hz	12	70 W	31 L	11 - 18°C	129 kWh/annum	34,5x48x47 cm	13,0Kg
69672	220-240 V; 50 Hz	18	70 W	50 L	11 - 18°C	146 kWh/annum	34,5x49x67 cm	17,0 Kg
69673	220-240 V; 50 Hz	28	70 W	71 L	11 - 18°C	179 kWh/annum	45x52x72,5 cm	24,3 Kg

# MERLOT

## Armarios con compresor

· Semiprofessional use ·

CE

ES

- Armario refrigerador con sistema de enfriamiento por compresor.
- Diseñados para refrigerar eficazmente botellas de vino y otras bebidas.
- La temperatura interior puede ser ajustada mediante el control electrónico.
- Acabado en acero inoxidable y cristal negro.
- Puerta con cámara de cristal templado y sistema de apertura con tirador.
- Estantes extraíbles acabados en madera.
- Silencioso y sistema antivibratorio.
- Pies regulables en altura.
- **NOTA:** deje suficiente espacio en la parte trasera (mínimo 5 cm) para permitir la salida del calor y una adecuada ventilación.

FR

- Cave à vin avec système de refroidissement par compresseur.
- Conçue pour refroidir efficacement les bouteilles de vin et autre boissons.
- La température intérieure peut être réglée à l'aide du contrôle électronique.
- Finitions en acier inoxydable et verre noir.
- Porte avec chambre en verre trempé et système d'ouverture avec poignée.
- Étagères extractibles avec finition en bois.
- Silencieuse et système anti-vibrations.
- Pieds réglables en hauteur.
- **REMARQUE:** laissez suffisamment d'espace dans la partie arrière (minimum 5 cm) pour permettre la sortie de la chaleur et une bonne ventilation.

EN

- Refrigerated cabinet with compressor cooling system.
- Designed to effectively cool bottles of wine and other beverages.
- The internal temperature can be adjusted using the electronic control.
- Stainless steel and black crystal finish.
- Door with tempered glass chamber and handle-operated opening system.
- Wood finish pull-out shelves.
- Silent, anti-vibration system.
- Height-adjustable legs.
- **NOTE:** leave enough space at the back (minimum 5 cm) to allow heat to escape and adequate ventilation.



Display luminoso de control de temperatura digital  
Luminous digital temperature control display



### Armario refrigerador de compresor

Refridisseur à vin à compresseur · Weinkühler mit Kompressor  
Compressor type wine cooler · Refrigerador de vinho do tipo compresso

Ref	€	W	Botellas	U.Venta
A 69700	519,60	85	12	1
B 69701	534,80	85	12	1
C 69702	828,50	85	18	1
D 69239	437,20	85	18	1
E 69238	466,20	85	28	1
F 69703	833,90	85	51	1

Ref	Tensión/Voltage	Botellas/Bottles	Potencia/Power	Temperatura Temp.	Consumo Consump.	Ruido Noise	Refrigerante Refrigerant	Dimensiones/Sizes	Peso/Weight
69700	220-240 V ; 50/60 Hz	12	85 W	5°C-18°C	107 kWh/annum	45 dB	R600A	44x47x53 cm	18,0 Kg
69701	220-240 V ; 50/60 Hz	12	85 W	5°C-18°C	136 kWh/annum	45 dB	R600A	25x45x79 cm	17,0 Kg
69702	220-240 V ; 50/60 Hz	18	85 W	5°C-18°C	145 kWh/annum	46 dB	R600A	34,5x48x83 cm	22,3 Kg
69239	220-240 V ; 50/60 Hz	18	85 W	5°C-18°C	120 kWh/annum	42 dB	R600A	34,5x45x77 cm	19,5 Kg
69238	220-240 V ; 50/60 Hz	28	85 W	5°C-18°C	189 kWh/annum	42 dB	R600A	43x45x84 cm	24,0 Kg
69703	220-240 V ; 50/60 Hz	51	85 W	5°C-18°C	156 kWh/annum	47 dB	R600A	49,5x56,5x85 cm	34,0 Kg



# BAR Refrigeradores

Professional use



**Puerta reversible**  
Reversible door

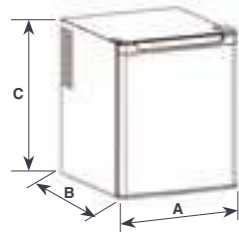

## Refrigerador minibar

Mini frigo bar · Minibar Kühlschrank  
Mini-bar refrigerator · Refrigerador mini-bar

Ref	€	W	U.Venta
<b>A</b> 69070	256,90	70	1
<b>B</b> 69075	256,90	70	1



**No introduzca alimentos o bebidas calientes**  
Do not introduce hot food or drinks

Ref	Tensión/Voltage	Potencia/Power	Cap./Capac.	Temperatura/Temp.	Consumo/Cons.	Ruido/Noise	Refrig./Rerig.	Dimensiones/Sizes A x B x C	Peso/Weight
69070	220-240 V; 50/60 Hz	70 W	38 L	6°C - 22°C	96 kWh/annum	26dB	R600a (27g)	43x41x51 cm	9,0 Kg
69075	220-240 V; 50/60 Hz	70 W	38 L	6°C - 22°C	96 kWh/annum	26dB	R600a (27g)	43x41x51 cm	9,0 Kg

**REFRIGERADOR TERMOELÉCTRICO: el control y regulación de la temperatura, dependerá de la temperatura ambiental del establecimiento**  
THERMOELECTRIC REFRIGERATOR: temperature control and regulation depend on the ambient temperature of the establishment

# MÁQUINAS DE HIELO Colección

Professional use



**Perfecta para una producción de grandes volúmenes**  
Perfect for large volume production

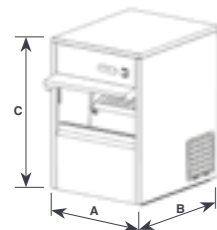

## Máquina de hielo PRO

Machine à fabriquer des glaçons · Eiswürfelmaschine  
Ice maker · Máquina de hielo

Ref	€	W	U.Venta
69320	1070,00	170	1

4 Kg

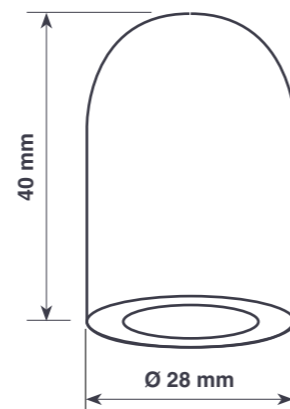

**Tamaño y forma cubito hielo**  
Escala: 1:1  
Ice cube size and shape  
Scale: 1:1

Ref	Tensión/Voltage	Potencia/Power	Cap. contenedor hielo Ice container cap.	Producción/Product.	Cubo/Ice (Sizes)	Dimensiones/Sizes A x B x C	Peso/Weight
69320	220-240 V; 50 Hz	170 W	4 Kg	>20 Kg/24h	Ø28x40 mm	38x48x59 cm	27 Kg



**En 10 o 12 minutos, obtendrá cubitos de hielo**  
In 10 to 12 minutes you will have ice cubes.



**Dispone de programador**  
It has a programmer

## Máquina de hielo ICE

Machine à glaçons · Eiswürfelmaschine  
Ice cubes maker · Máquina de fazer gelo

Ref	€	W	L	U.Venta
69314	413,30	150	1,50	1



**9 cubitos por ciclo (cada ciclo es de 8 min aproximadamente)**  
9 cubes per cycle (each cycle is approximately 8 min.)

**Ventana transparente**  
Transparent window



**ABS PP**

Plastic Polypropilene

## Máquina de hielo NORD

Machine à glaçons · Eiswürfelmaschine  
Ice cubes maker · Máquina de fazer gelo

Ref	€	W	L	U.Venta
69340	270,10	100	2,20	1

Ref	Tensión/Voltage	Potencia/Power	Capacidad/Capacity	Contenedor/Cont.	Producción/Product.	Dimensiones/Sizes	Peso/Weight
69314	220-240 V; 50/60 Hz	150 W	1,50 L	0,6 Kg	10-15 Kg/24h	32x32x38 cm	11,30 Kg
69340	220-240 V; 50/60 Hz	100 W	2,20 L	0,7 Kg	12 Kg/24h	36x24x33 cm	8,00 Kg

Household use

- Funcionamiento sencillo; rellena manualmente el depósito de agua y obtén cubitos de hielo en pocos minutos. Sin necesidad de toma de agua.
- Depósito de agua de 1,50 L (69314) / 2,2 L (69340) de capacidad.
- Produce hasta 10 - 15 kg por día (69314).
- Produce hasta 12 kg por día y 9 cubitos en cada ciclo (69340).
- Forma del cubito de hielo: bala (Ø26x30 mm).
- Ciclo de producción totalmente automático y silencioso.
- Detección por infrarrojos, se detendrá automáticamente al detectar el contenedor lleno.
- Alarma acústica cuando el compartimento de hielo está lleno o si se necesitan más agua.
- Incluye pala para la extracción de los cubitos de hielo.
- Drenaje en la base, no requiere instalación o desagüe.

- Fonctionnement simple : remplissez le réservoir d'eau et obtenez des glaçons en quelques minutes. Ne nécessite pas d'évacuation d'eau.
- Réservoir d'eau d'une capacité de 1,50 L (69314) / 2,2 L (69340).
- Produit jusqu'à 10 - 15 kg par jour (69314).
- Produit jusqu'à 12 kg par jour et 9 glaçons à chaque cycle (69340).
- Forme du glaçon : cylindrique (Ø26x30 mm).
- Cycle de production entièrement automatique et silencieux.
- Détection par infra-rouges ; la machine s'arrêtera automatiquement si elle détecte que le conteneur est plein.
- Alarme sonore lorsque le compartiment à glaçons est plein ou lorsqu'il faut remettre de l'eau.
- Inclut une pelle pour prendre les glaçons.
- Drainage à la base, ne requiert pas d'installation spécifique ou de tuyau d'écoulement.

- Easy to use. Fill the water tank manually and get ice cubes in just a few minutes.
- Doesn't need its own plumbing.
- Water tank with 1.50 L (69314) / 2.2 L (69340) capacity.
- Makes up to 10-15 kg a day (69314).
- Makes up to 12 kg a day and 9 ice cubes in every cycle (69314).
- Ice cube shape: bullet (Ø 26 x 30 mm).
- Totally automatic and silent production cycle.
- Infrared detection. It stops automatically when it detects a full container.
- It makes a sound when the ice compartment is full or if more water is needed.
- A blade is included for removing the ice cubes.
- The draining in the base does not require installation or a drain.

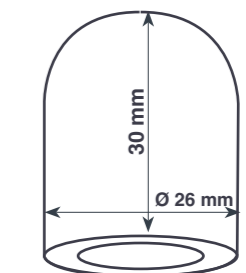

**Tamaño y forma cubito hielo**  
Escala: 1:1  
Ice cube size and shape  
Scale: 1:1

# PICADORAS HIELO

## Colección

· Semiprofessional use ·



Compatible con las máquinas de hielo LACOR  
Compatible with LACOR ice machines



Embudo de llenado extraíble  
Removable cone

**Picadora de hielo PRO**  
Broyeur à glace · Eis-Crusher  
Ice crusher · Picadora de gelo

Ref	€	W	L	Producción (Kg/h)	U.Venta
69313	113,60	60 - 80	2,80	12	1

- Ideal para la preparación de cócteles, combinados, granizados, limonadas, refrescos, postres fríos, etc.
- Una manera simple y rápida de obtener hielo picado en 30 segundos presionando un botón
- Cuerpo de acero inoxidable
- Embudo de llenado superior extraíble de Ø140 mm
- Recipiente de recogida extraíble con una capacidad de 2,80 L
- Anclajes de seguridad en el recipiente de recogida
- Interruptor de encendido/apagado en la parte frontal
- Todas las partes desmontables son aptas para lavavajillas
- 4 patas con ventosas, aporta estabilidad a la hora del uso

- Idéal pour la préparation de cocktails, mélanges, granités, limonades, rafraîchissements, desserts froids, etc.
- Une façon simple et rapide d'obtenir de la glace pilée en 30 secondes, simplement en appuyant sur un bouton
- Corps en acier inoxydable
- Entonnoir de remplissage supérieur extractible de Ø140 mm
- Récipient d'accueil extractible avec une capacité de 2,80 L
- Ancrages de sécurité sur le récipient d'accueil
- Interrupteur de marche/arrêt sur la partie avant
- Toutes les parties démontables sont aptes pour aller au lave-vaisselle
- 4 pieds avec ventouses qui confèrent une stabilité lors de l'utilisation

- Ideal for preparing cocktails, drinks, slushies, lemonade, soft drinks, cold desserts, etc.
- A simple quick way to make crushed ice in 30 seconds by pressing a button
- Stainless steel body Ø140 mm removable top intake cone
- Removable crushed ice container with a capacity of 2.80 L
- Safety anchors on the crushed ice container
- Front On/off switch
- All removable parts are dishwasher safe
- 4 legs with suction cups, provides stability in operation

Ref	Tensión/Voltage	Potencia/Power	Cap. hielo/Ice cap.	Capacidad/Capacity	Embudo/Funnel	Dimensiones/Sizes	Peso/Weight
69313	220-240 V; 50/60 Hz	60-80 W	12 Kg/h	2,80 L	Ø14 cm	17x29x47,5 cm	11,30 Kg

New



Cuchillas especiales  
Special blades

- Fabricada en acero inoxidable 18/10 y diseñada para uso profesional.
- Robusto y duradero con un rendimiento excepcional: producción de 90 kg/hora.
- Ideal para preparar hielo para granizados, mojitos y otras bebidas con hielo.
- Microinterruptor de seguridad.
- Funcionamiento automático.
- Recipiente con una capacidad de 3 L.
- Máxima estabilidad gracias a sus 4 pies antideslizantes.

- Fabriqué en acier inoxydable 18/10 et conçu pour un usage professionnel.
- Robuste et durable, avec un rendement exceptionnel : production de 90 kg/heure.
- Idéal pour préparer de la glace pour les granités, les mojitos et autres boissons contenant de la glace pilée.
- Micro-interrupteur de sécurité.
- Fonctionnement automatique.
- Récipient avec une capacité de 3 L.
- Stabilité maximale grâce à ses 4 pieds antidérapants.

- Made of 18/10 stainless steel and designed for professional use.
- Robust and long-lasting with exceptional performance: 90 kg/hour production.
- It's perfect for preparing ice for shaved ice, mojitos and other iced drinks.
- Safety micro-switch.
- Automatic operation.
- Container with 3L capacity.
- Maximum stability because of the 4 non-slip feet.

**Picadora de hielo ICE**  
Broyeur à glaçons · Eis-Crusher  
Ice crusher · Picadora de gelo

Ref	€	Ø (cm)	h (cm)	U.Venta
69431	496,90	9	22,5	1

Ref	Tensión/Voltage	Potencia/Power	Velocidad/Speeds	Producción/Produt.	Capacidad/Capacity	Dimensiones/Sizes	Peso/Weight
69431	220-240 V; 50-60 Hz	200 W	1000 r.p.m.	90 Kg/h	3,00	32,9x18,7x53,3 cm	5,48 Kg



**Picadora de hielo MARBLE**  
Broyeur à glaçons · Eis-Crusher  
Ice crusher · Picadora de gelo

Ref	€	W	L	U.Venta
69310	85,90	100	0,50	1

Ref	Tensión/Voltage	Potencia/Power	Cap. hielo/Ice cap.	Capacidad/Capacity	Embudo/Funnel	Dimensiones/Sizes	Peso/Weight
69310	220-240 V; 50/60 Hz	100 W (5.500 r.p.m.)	-	0,50 L	-	18x20,5x46,5 cm	5,10 Kg
69313	220-240 V; 50/60 Hz	60-80 W	12 Kg/h	2,80 L	Ø14 cm	17x29x47,5 cm	11,30 Kg

- Ideal para la preparación de cócteles, combinados, granizados, limonadas, refrescos, postres fríos, etc.
- Una manera simple y rápida de obtener hielo picado en 30 segundos presionando un botón.
- Cuchillas de acero inoxidable.
- Interruptor de encendido/apagado.
- Todas las partes desmontables son aptas para lavavajillas.

- Idéal pour la préparation de cocktails, mélanges, granités, limonades, rafraîchissements, desserts froids, etc.
- Une façon simple et rapide d'obtenir de la glace pilée en 30 secondes, simplement en appuyant sur un bouton.
- Lames en acier inoxydable.
- Interrupteur de marche/arrêt.
- Toutes les parties démontables sont aptes pour aller au lave-vaisselle.

- Ideal for preparing cocktails, drinks, slushies, lemonade, soft drinks, cold desserts, etc.
- A simple quick way to make crushed ice in 30 seconds by pressing a button.
- Stainless steel blades.
- Front On/off switch.
- All removable parts are dishwasher safe.

# FREEZE

## Máquina enfriacopas

Professional use



- Gracias a su diseño, la FREEZE es perfecta para cualquier local ya que se adapta a todo tipo de superficies, ocupando el mínimo espacio.
- Se puede ubicar donde se precise según las necesidades de cada ocasión.
- Perfecta para negocios de mucha actividad.
- Fabricado en acero inoxidable.
- Conexión a botella de CO<sub>2</sub> de 28 ó 36 Kg.
- Contador de operaciones.
- Luces tipo LED de activación por impulsos de gas.
- Sistema de conexión a botella con sistema de seguridad incluido.

- Thanks to its design, the FREEZE is perfect for any local adapts to all types of surfaces, taking up a minimum of space.
- Can be placed where required according to the needs of each occasion.
- Perfect for busy business.
- Made of steel stainless.
- Connection to CO<sub>2</sub> bottle of 28 or 36 Kg.
- Counter operations.
- Lights activation type LED by impulses from gas.
- Bottle with safety system including system.

**Precios NO sujetos al sistema de descuentos habitual de LACOR**  
 Prix non soumis au système habituel de remises de LACOR  
 Prices not subject to the usual discount system of LACOR

### Máquina enfriacopas FREEZE

Machine à givrer les verres · Gläser-Kühlmaschine  
 Glass cooler machine · Máquina para enfriar copas

Ref	€	W	U.Venta
69300	3155,00	25	1

Ref	Tensión/Voltage	Potencia/Power	Programas/Program.	Dimensiones/Sizes	Peso/Weight
69300	220-240 V; 50/60 Hz	25 W	4	22,8x30,5x 50 cm	12 Kg

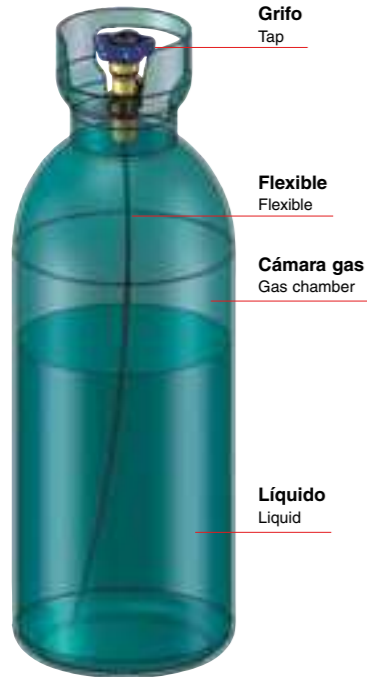

#### ¿Qué tipo de gas utilizamos?

El gas que utilizan nuestras máquinas es Gas carbónico alimentario en estado líquido. El Dióxido de Carbono, también denominado óxido de carbono (IV), gas carbónico y anhídrido carbónico, CO<sub>2</sub>, es insípido, incoloro, inodoro y no inflamable.

Aunque la forma más común en que se encuentra el CO<sub>2</sub> es en estado gaseoso, bajo determinadas condiciones se puede encontrar también en estado líquido o sólido. Estas botellas están destinadas para uso médico y alimentario y lo que las diferencia del resto es que en su interior cuenta con una sonda que extrae el líquido criogénico que al liberarse alcanza una temperatura de -79,8 °C

#### Seguridad LACOR

- 1.- Funcionamiento a base de gas carbónico líquido alimentario
- 2.- Control de presión de gas. Control de temperatura de congelación del gas ajustable de -8 a -55°C
- 3.- Fabricado en Acero Inoxidable de uso médico y alimentario. Todos los conductos interiores están fabricados en AISI-316 garantizando las óptimas condiciones alimentarias e higiénico-sanitarias
- 4.- Adaptable a cualquier tamaño de copa o vaso
- 5.- Exclusivo sistema de seguridad patentado y control para presiones superiores a 100 bar

#### Nuestros artículos cumplen las siguientes normativas:

- 1.- Directiva 2006/95/CE de seguridad eléctrica
- 2.- Directiva 2006/108/CE de compatibilidad electromagnética
- 3.- Directiva 2006/42/CE de máquinas
- 4.- Norma UNE-EN ISO 12100-1:2004
- 5.- Norma UNE-EN ISO 12100-2:2004
- 6.- Norma EN 614-1:1996
- 7.- Norma UNE-EN ISO 13850:2007
- 8.- Norma UNE-EN 60335-1

#### What type of gas do we use?

Our machines use liquid food grade Carbon dioxide gas. Carbon Dioxide, also called carbon oxide (IV), carbonic gas and carbon anhydride, CO<sub>2</sub>, is insipid, colourless, odourless and not flammable.

Although the most common state of CO<sub>2</sub> is gaseous, under certain conditions it can also be found in liquid or solid state. These bottles are used for medical and food uses and they are different from the rest in that their interiors have a probe that extracts the cryogenic liquid which when freed reaches temperatures of -79.8 °C

#### LACOR Safety

- 1.- Operability based on liquid food grade carbon dioxide gas
- 2.- Control of gas pressure. Control of freezing temperature of the gas adjustable from -8 to -55 °C
- 3.- Manufactured from Stainless Steel for medical and food use. All the internal conducts are manufactured from AISI-316 guaranteeing optimal food and hygienic-health condition
- 4.- Adaptable to any size of glass
- 5.- Exclusive patented safety system and control for pressures above 100 bar

#### Our articles fulfil the following standards:

- 1.- Directive 2006/95/CE for electrical safety
- 2.- Directive 2004/108/EC for electromagnetic compatibility
- 3.- Directive 2006/42/CE for machinery
- 4.- UNE-EN ISO 12100-1:2004 Standard
- 5.- UNE-EN ISO 12100-2:2004 Standard
- 6.- EN 614-1:1996 Standard
- 7.- UNE-EN ISO 13850:2007 Standard
- 8.- UNE-EN 60335-1 Standard



# PROFESIONALES

## Básculas

Professional use



- Batería interna recargable (autonomía de 15 días).
- Visor de nivel, planitud.
- Avisador acústico de sobrecarga.
- Teclado intuitivo y de fácil uso. Funciones de calculadora.
- Acumulación de importes.
- Unidades de medida (Kg · oz · Libras). Función de tara.
- Libro de instrucciones en 7 idiomas.

- Batterie interne rechargeable (autonomie 15 jours).
- Indicateur de niveau, de planéité.
- Avertisseur acoustique de surcharge.
- Clavier intuitif d'utilisation facile. Fonctions de calculatrice.
- Accumulation de sommes
- Unités de mesure: (Kg · Oz · Livres). Fonction de tare
- Mode d'emploi en 7 langues

- Rechargeable internal battery (last 15 days).
- Level and fatness indicator .
- Overload alarm.
- Intelligent and easy-to-use keyboard. Calculator funtions. Total counter.
- Measurement units: (Kg · Oz · pounds). Tare function
- Instructions book in 7 languages.

**CERTIF.: 89/336/ECC, 91/263/EEC, 92/31/ECC, 93/68/EEC en 50 082 - 1:1992**

### Báscula industrial con base

Balance industrielle avec base · Industrieller Küchenwaage mit Sockel  
 Industrial scale with base · Balança industrial com base

Ref	€	U.Venta
61700	1146,70	1

Ref	Tensión/Voltage	Tara/Tare	Dimensiones/Sizes	Peso/Weight
61700	220-240 V / 50-60 Hz	150 Kgr (20 g)	49x75x90 cm	45 Kg

**Plataforma inoxidable 30x24 cm**  
**Plataforma extraíble**  
**Doble display (Delante / Detrás)**  
**Teclado intuitivo y de fácil uso**  
**Patas de apoyo regulables**

St. Steel platform, 30x24 cm  
 Removable platform  
 Double display (Front / Back)  
 Intelligent and easy-to-use keyboard  
 Adjustable support feet



### Báscula profesional electrónica

Balance électronique professionnelle · Elektronische Profi-Waagen  
 Electronic professional scale · Balança eletrônica profissional

Ref	€	Tara
61716	472,20	15kg/5g
61730	508,10	30kg/10g

- Batería interna recargable (autonomía 15 días).
- Visor de nivel, planitud.
- Avisador acústico de sobrecarga.
- Funciones cambio.
- Seis memorias programables.
- Unidades de medida (Kgs., Oz., Libras). Función de tara.
- Libro de instrucciones en 7 idiomas.

- Batterie interne rechargeable (Autonomie 15 jours).
- Indicateur de niveau, de planéité.
- Avertisseur acoustique de surcharge.
- Fonctions changement.
- Six mémoire programmable.
- Unités de mesure: (Kgs., Oz., Livres). Fonction de tare.
- Mode d'emploi en 7 langues.

- Rechargeable internal battery (Last 15 days).
- Level and fatness indicator.
- Overload alarm.
- Change funtions.
- Six programmable memories.
- Measurement units: (Kgrs., Oz., pounds). Tare function.
- Instructions book in 7 languages.

**CERTIF.: OIML R76 Clase III, 60/384/ECC**

Ref	Tensión/Voltage	Potencia/Power	Tara/Tare	IP	Dimensiones/Sizes	Peso/Weight
61716	220-240 V / 50-60 Hz	0,2 W (max)	15 Kgr (5 g)	IPX 54	30x32x12 cm	4,60 Kg
61730	220-240 V / 50-60 Hz	0,2 W (max)	30 Kgr (10 g)	IPX 54	30x32x12 cm	4,60 Kg

No válidas para uso comercial · Utilisation interdite pour toutes transactions commerciales · Not for trade

# LED Pizarra

Professional use



8 colores para usar con la pizarra eléctrica Led  
No tóxicos, fácil de limpiar  
8 colors to use with the Led electric board  
Non toxic, easy to clean



## Rotuladores fluorescentes 8 colores

Marqueurs fluorescents 8 couleurs · 8-Farben fluoreszierenden marker  
Fluorescent markers 8 colors · Maracadores fluorescentes 8 cores

Ref	€	cm	U.Venta
39161	33,20	10	1

- Llamativo sistema de promoción. Gran impacto visual.
- Ideal para cualquier tipo de establecimiento: restaurantes, cafeterías, pubs, tiendas de alimentación, etc.
- Diseñadas para colocarlas tanto vertical como horizontalmente gracias a la cadena suministrada
- Uso similar de las pizarras normales, se escribe sobre la superficie (cristal templado) con rotuladores fluorescentes (Ref.:39161) y se borra con una simple bayeta de fibra.
- Realice el dibujo en la pizarra totalmente desenchufada.

- Système de promotion accrocheur. Grand impact visuel.
- Idéal pour tout type d'établissement : restaurants, cafés, pubs, magasins d'alimentation, etc.
- Conçu pour être placé aussi bien à la verticale qu'à l'horizontale, grâce à la chaîne fournie.
- Semblables à des tableaux normaux, ils permettent d'écrire sur la surface (verre trempé) avec des marqueurs fluorescents (Réf.:39161) et essuyés avec un simple chiffon en fibre.
- Dessinez sur le tableau complètement débranché.

- Eye-catching promotion system. Great visual impact.
- Ideal for any type of establishment: restaurants, cafés, pubs, food shops, etc.
- Designed to be placed both vertically and horizontally, thanks to the supplied chain
- Similar to normal blackboards, they are used for writing on the surface (tempered glass) with fluorescent markers (Ref.:39161) and wiped off with a simple fibre cloth.
- Draw on the blackboard completely unplugged.



## Pizarra LED

Tableau lumineux à LED · LED Tafel  
Blackboard LED · Ardósia LED

Ref	€	W	U.Venta
<b>A</b> 39140	102,70	2	1
<b>B</b> 39160	141,00	2	1

Ref	Tensión/Voltage	Potencia/Power	Funcioned/Functions	Dimensiones/Sizes	Peso/Weight
39140	220-240 V; 50/60 Hz	2 W	38	40x60 cm	2,35 Kg
39160	220-240 V; 50/60 Hz	2 W	38	60x80 cm	4,50 Kg

NO incluidos  
NOT included



# ELÉCTRICOS Afiladores

Household use



**Afilador de cuchillos eléctrico TitanPRO**  
Affûteuse de couteaux électrique · Elektrische Schärmaschine  
Electric knife sharpener · Afiador de facas electrónico

Ref	€	U.Venta
69341	39,10	1



**Ruedas de Alundum blanco**  
White alundum wheel



**Afilador de cuchillos eléctrico ROND**  
Affûteuse de couteaux électrique · Elektrische Schärmaschine  
Electric knife sharpener · Afiador de facas electrónico

Ref	€	U.Venta
69141	32,10	1



**Afilador de cuchillos eléctrico PRO**  
Affûteuse de couteaux électrique · Elektrische Schärmaschine  
Electric knife sharpener · Afiador de facas electrónico

Ref	€	U.Venta
69261	124,20	1



**Afilador de cuchillos eléctrico MOUSE**  
Affûteuse de couteaux électrique · Elektrische Schärmaschine  
Electric knife sharpener · Afiador de facas electrónico

Ref	€	U.Venta
60359	49,10	1

Ref: 69341  
**Características · Characteristics:**  
Tensión · Voltage: 220-240 V; 50-60 Hz  
Potencia · Power: 60 W  
Dimensiones · Sizes: 17x8x10 cm  
Peso · Weight: 0,60 kg

- Permiten mantener los utensilios en perfecto estado.
- Diseño elegante, acabado metalizado.
- Dispone de diferentes ranuras para poder afilar distintos tipos de utensilios como cuchillos, tijeras o destornilladores de punta plana.
- El motor gira a la velocidad óptima para que el afilado de los utensilios sea preciso y duradero.
- 100% seguro: en su base se incluyen cuatro ventosas de fijación para evitar que el afilador se mueva durante su uso.

- Permet de maintenir les ustensiles en parfait état.
- Design élégant, finition métallisée.
- Dispose de différentes rainures pour pouvoir aiguiser différents types d'ustensiles tels que des couteaux, des ciseaux ou des tournevis.
- Le moteur tourne à une vitesse optimale pour que l'aiguisage des ustensiles soit précis et durable.
- 100% antidérapant : sa base possède quatre ventouses de fixation pour éviter que l'aiguiser bouge pendant son utilisation.

- Keeping kitchen utensils in perfect condition.
- Elegant design, metallic finish.
- It has different grooves for sharpening different utensils, like knives, scissors and flat-head screwdrivers.
- The motor spins at the optimal speed for precise and long lasting sharpening.
- 100% safe. There are four suction cups on the base to keep the sharpener from moving during use.

Ref: 69141  
**Características · Characteristics:**  
Tensión · Voltage: 220-240 V; 50 Hz  
Potencia · Power: 60 W  
Dimensiones · Sizes: 173,5x15x9 cm  
Peso · Weight: 0,64 kg

Ref: 69261  
**Características · Characteristics:**  
Tensión · Voltage: 220-240 V; 50-60 Hz  
Potencia · Power: 180 W  
Dimensiones · Sizes: 32x11,5x210 cm  
Peso · Weight: 2,20 kg



**Fase 1: Alta abrasividad** · high abrasiveness  
**Fase 2: Afilado fino** · thin sharp  
**Fase 3: Microafilado** · micro-sharp

Ref: 60359  
**Características · Characteristics:**  
Tensión · Voltage: 220-240 V; 50-60 Hz  
Potencia · Power: 180 W  
Dimensiones · Sizes: 16x11x7,5 cm  
Peso · Weight: 20,56 kg



**Cuchillos lisos** · Smooth knives  
**Rejilla salida viruta** · Chip outlet grid

# CUCHILLOS

## Estirizador



IP21



**Esterilización mediante rayos ultravioletas germicidas que transforman el oxígeno en ozono, destruyendo bacterias, hongos y virus.**

Sterilisation by ultraviolet germicidal rays that transform oxygen into ozone, destroying bacteria, fungi and viruses.

### Armario esterilizador cuchillos ultravioleta

Armoire à stériliser · Sterilisierungsschank  
Knife sterilization · Armário esterilizador facas

Ref	€	W	U.Venta	
A 39012	656,10	15	1	10 cuchillos · 10 Knives
B 39124	879,50	15	1	20 cuchillos · 20 Knives

Ref	Cuchillos/Knives	Tensión/Voltage	Potencia/Power	Reloj/Timer	Dimensiones/Sizes	Peso/Weight
39012	10	230 V; 50/60 Hz	15 W	120 min	36x13x57 cm	4,785 Kg
39124	20	230 V; 50/60 Hz	15 W	120 min	45x13x57 cm	5,630 Kg

# MATAMOSQUITOS

## Colección



ES

- Perfecto para el uso en lugares públicos como bares, restaurantes, hoteles, etc.
- Su elegante diseño es ideal para darle un toque moderno a cualquier espacio.
- Discreto, silencioso y seguro, sin descarga eléctrica.
- Es una alternativa perfecta a los insecticidas y matamosquitos tradicionales.
- No contamina (sin químicos ni venenos); evita la fragmentación del insecto y la dispersión de las bacterias.
- La luz ultravioleta atrae todo tipo de insectos voladores los cuales se eliminan mediante el papel adhesivo.
- El papel adhesivo se sustituye en segundos, ofreciendo una limpieza fácil y rápida.

FR

- Parfait pour une utilisation dans des lieux publics tels que des bars, restaurants, hôtels, etc.
- Son style est idéal pour apporter une touche moderne à tout type d'espace.
- Discret, silencieux et sûr, sans décharge électrique.
- Il s'agit d'une excellente alternative aux insecticides et tue-mouches traditionnels.
- Ne pollue (pas de produits chimiques ou de poisons), évite la fragmentation de l'insecte et la dispersion des bactéries.
- La lumière ultraviolette attire tout type d'insectes volants, qui sont éliminés à travers le papier adhésif.
- Le remplacement du papier adhésif s'effectue en quelques secondes, permettant ainsi un nettoyage facile et rapide.

EN

- Perfect for public places like bars, restaurants, hotels, etc.
- It's elegant design is perfect for giving a modern touch to any space.
- It's discrete, quiet and safe and doesn't produce electric shocks.
- It's a perfect alternative to insecticides and traditional.
- Doesn't pollute (no chemicals or poisons), it doesn't crush insects and spread bacteria.
- The UV light attracts all kinds of flying insects which get eliminated using adhesive paper.
- The adhesive paper can be changed in seconds for fast and easy cleaning.

Sin descargas eléctricas  
Doesn't produce electric shocks



### Matamosquitos DECOR

Anti-moustiques · Fliegenfänger  
Moskito killer · Mata mosquitos

Ref	€	W	Área protección	U.Venta
39135	102,50	35	60 m <sup>2</sup>	1

\* Se recomienda reemplazar el papel adhesivo cada 10 días pero si más de 2/3 del papel está cubierto de moscas, reemplace el papel  
It is recommended that you replace the sticky fly paper every 10 days but if more than 2/3 of the paper is covered in flies, replace the paper

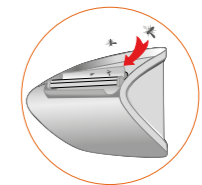

### Set de 3 láminas adhesivas

Ensemble de 3 feuilles adhesives · Set von 3 Klebe Folie  
Set of 3 adhesives sheet · Conjunto de 3 folhas adesivas

Ref	€	U.Venta
R39135C	13,30	1

Ref	Tensión/Voltage	Potencia/Power	Área protec./Prot. area	Lámparas/Lamps	L. cable./Cord length	Dimensiones/Sizes	Peso/Weight
39135	220-240 V; 50/60 Hz	35 W	60 m <sup>2</sup>	2 x 15W	115 cm	42x23,8x17,3 cm	1,36 Kg



### Matamosquitos LUCE

Anti-moustiques · Fliegenfänger  
Moskito killer · Mata mosquitos

Ref	€	W	Área protección	U.Venta
A 39126	90,30	11	150 m <sup>2</sup>	1
B 39127	110,50	13	300 m <sup>2</sup>	1

- Diseñado para lugares públicos como bares, restaurantes, hoteles, etc.
- Dispone de lámparas UV-A de alta calidad y con una longitud de onda óptima para atraer a todo tipo de insectos voladores.
- Una alternativa perfecta a los insecticidas, libre de contaminación e inocuo para los humanos.
- Dispone de rejilla metálica de alto voltaje en el interior donde los insectos son electrocutados con una tasa de eliminación instantánea y del 100%.
- Bandeja desmontable recoge insectos en la parte inferior, facilita la limpieza.
- Se instala fácilmente. Incluye dos cadenas para colgar.

- Conçu pour des lieux publics tels que les bars, les restaurants, les hôtels, etc.
- Dispose de lampes UV-A de grande qualité avec une longueur d'onde optimale pour attirer tout type d'insectes volants.
- Une alternative parfaite aux insecticides, sans contamination et inoffensif pour les humains.
- Dispose d'une grille métallique de haut voltage à l'intérieur où les insectes sont électrocutés avec un taux d'élimination instantanée de 100%.
- Plateau démontable ramasse-insectes dans la partie inférieure, qui facilite le nettoyage.
- Installation facile. Inclut deux chaînes pour l'accrocher.

- Designed for public spaces such as bars, restaurants, hotels, etc.
- Powerful high-quality UV-A lamps with an optimal wavelength to attract all types of flying insects.
- A perfect alternative to insecticides, free from contamination and harmless to humans.
- It has an internal high-voltage metal grill that instantaneously electrocutes insects with a 100% elimination rate.
- Removable tray that collects insects on the bottom, facilitating cleaning.
- Installs easily. Includes two chain for hanging.

Vida útil de trabajo  
Functional lifespan  
**20.000 h**

Vida útil de trabajo: 10.000 h  
Useful working life: 10,000 h

Incluye cuerda para colgar  
Includes a cord for hanging



PP  
polypropylene

### Matamosquitos WHITE

Anti-moustiques · Mückenfalle  
Mosquito killer · Mata-mosquitos

Ref	€	W	Área protección	U.Venta
39129	64,90	3,5	50 m <sup>2</sup>	1

- Uso interior: hogar, oficinas, hoteles, locales comerciales, restaurantes, etc.
- Dispone de 2 lámparas LED de alta calidad y con una longitud de onda óptima para atraer a todo tipo de insectos voladores.
- Una alternativa perfecta a los insecticidas, libre de contaminación e inocuo para los humanos.
- Rejilla metálica de 2500V en el interior donde los insectos son electrocutados.

- Utilisation en intérieur : logements, bureaux, hôtels, boutiques, restaurants, etc.
- Dispose de 2 ampoules LED de grande qualité et d'une longueur d'onde optimale pour attirer tout type d'insectes volants.
- Une alternative parfaite aux insecticides, sans contamination et inoffensive pour les humains.
- Dispose d'une grille métallique de 2500V à l'intérieur, où les insectes sont électrocutés.

- Designed for indoor use: Home, offices, hotels, businesses, restaurants, etc.
- It has 2 high quality LED lights with an optimal wavelength for attracting all kinds of flying insects.
- It's a perfect alternative to insecticide because it's pollution free and innocuous to humans.
- It has a 2500 V metal screen inside where insects are electrocuted.

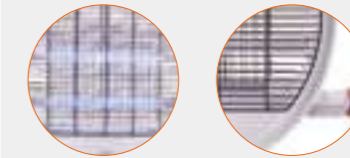

Ref	Tensión/Voltage	Potencia Power	Longitud onda Wavelength	Descarga eléct. Electric shock	Área protección Protection area	Vida útil Useful life	Cable Cord	Dimensiones Sizes	Peso Weight
39129	220-240 V; 50/60 Hz	3,5 W	398 m	2500 V	50 m <sup>2</sup>	10.000 h	1,50 m	Ø36,6x8,3 cm	1,40 Kg

Soporte colgador  
Luz ultravioleta  
Bandeja recoge mosquitos  
Hanger support  
Ultraviolet light  
Tray collection mosquitoes

Soporte colgador  
Luz ultravioleta  
Bandeja recoge mosquitos  
Ventilador  
Hanger support  
Ultraviolet light  
Tray collection mosquitoes  
Ventilator



### Matamosquitos NET

Appareil anti-moustiques noir · Fliegenfänger, schwarz  
Moskito killer black · Mata mosquitos preto

Ref	€	W	Área protección	U.Venta
A 39138	20,90	4	40 m <sup>2</sup>	1
B 39139	23,60	6	60 m <sup>2</sup>	1

Ref	Tensión/Voltage	Potencia/Power	Area protec./Prot. area	Dimensiones/Sizes	Peso/Weight
39138	220-240 V; 50/60 Hz	4 W	40 m <sup>2</sup>	Ø12x25 cm	350 g
39139	220-240 V; 50/60 Hz	6 W	60 m <sup>2</sup>	Ø12x33 cm	875 g
39133	220-240 V; 50/60 Hz	13 W	50 m <sup>2</sup>	Ø27x27 cm	950 g

### Matamosquitos BLACK

Appareil anti-moustiques · Fliegenfänger  
Moskito killer · Mata mosquitos

Ref	€	W	Área protección	U.Venta
39133	35,60	13	50 m <sup>2</sup>	1



Protección  
Protection  
**IPX0**

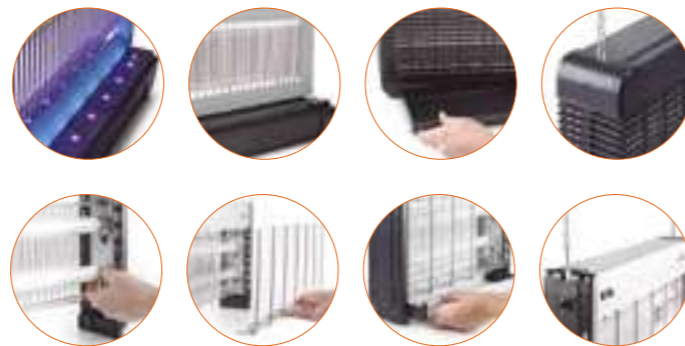

### Matamosquitos CAPTER

Anti-moustiques · Fliegenfänger  
Moskito killer · Mata mosquitos

Ref	€	W	Área protección	U.Venta
A 39134	75,00	26	80 m <sup>2</sup>	1
B 39136	83,90	30	100 m <sup>2</sup>	1

Ref	Tensión/Voltage	Potencia/Power	Bombillas/Bulbs	Area protec./Prot. area	Descarga/Shock	Dimensiones/Sizes	Peso/Weight
39126	220-240 V; 50/60 Hz	11 W	16 UV-A LED	150 m <sup>2</sup>	4000 V	33x10x36,3 cm	1,50 Kg
39127	220-240 V; 50/60 Hz	13 W	20 UV-A LED	300 m <sup>2</sup>	4000 V	47x10x36,3 cm	3,00 Kg
39134	220-240 V; 50/60 Hz	26 W	2x10W UV-A LED	80 m <sup>2</sup>	2000 V	38,5x9x31 cm	2,75 Kg
39136	220-240 V; 50/60 Hz	30 W	2x15W UV-A LED	100 m <sup>2</sup>	2000 V	49,5x9x31 cm	3,15 Kg

# CALENTADORES

## Colección

Professional use



ES

- Ideal para bares y restaurantes con mesas en el exterior.
- Funciona mediante lámparas de calentamiento halógeno infrarrojos.
- Malla protectora para evitar quemaduras.
- Resistente al polvo y agua (IP).

FR

- Idéal pour les bars et les restaurants ayant des tables à l'extérieur.
- Fonctionne à l'aide de lampes de réchauffement halogènes par infrarouges.
- Maillage de protection pour éviter les brûlures.
- Résistant à la poussière et à l'eau (IP).

EN

- Ideal for bars and restaurants with tables outside.
- Powered by infrared halogen heating lamps.
- Protective mesh to prevent burns.
- Dust and water resistant (IP).

¿Qué es la clasificación IP? · What is the IP classification?

### IP 54

1º dígito; protección contra objetos y polvo 1st digit; protection against objects and dust	2º dígito; protección contra líquidos 1st digit; protection against liquids
<b>IP0:</b> Sin protección · Without protection	<b>IPX0:</b> Sin protección · Without protection
<b>IP1:</b> Protección contra objetos con un Ø mayor de 50 mm Protection against objects with Ø greater than 50 mm	<b>IPX1:</b> Protección contra gotas de agua Protection against water drops
<b>IP2:</b> Protección contra objetos con un Ø mayor a 12 mm Protection against objects with Ø greater than 12 mm	<b>IPX2:</b> Protección contra el goteo de agua con una inclinación de 15° · Protection against dripping water with an inclination of 15°
<b>IP3:</b> Protección contra objetos con un Ø mayor a 2,5 mm Protection against objects with Ø greater than 2,5 mm	<b>IPX3:</b> Protección contra pulverización Protection against spray
<b>IP4:</b> Protección contra objetos con un Ø mayor a 1 mm Protection against objects with Ø greater than 1 mm	<b>IPX4:</b> Protección contra salpicaduras · Splash protection
<b>IP5:</b> Protección contra polvo · Protection against dust	<b>IPX5:</b> Protección contra chorros de agua Protection against water jets
<b>IP6:</b> A prueba de polvo · Testing against dust	<b>IPX6:</b> Protección contra aguaceros Protection against downpours
	<b>IPX7:</b> Protección contra la inmersión durante un tiempo determinado · Protection against immersion for a certain time
	<b>IPX8:</b> Protección contra permanencia bajo agua Protection against permanence under water

Rejilla protectora  
Protective grill



Selector nivel de calentamiento  
Heating level selector



- Desmontable en 3 partes, lo cual facilita el almacenaje de larga duración.
- El cabezal del calentador tiene un radio de giro de 40°.
- Base redonda y pesada para una mejor estabilidad y seguridad.
- Seguro y respetuoso con el medio ambiente, no produce ni ruidos ni olores.
- Incluye unos accesorios para el anclaje del calefactor.

- Démontable en 3 parties, ce qui facilite le rangement de longue durée.
- La tête du chauffage a un rayon de rotation de 40°.
- Base ronde et lourde pour une meilleure stabilité et sécurité.
- Sûr et respectueux de l'environnement, ne produit ni bruit ni odeurs.
- Inclut des accessoires pour l'ancrage du chauffage.

- Can be disassembled into 3 parts for easy long term storage.
- The head of the heater has a 40° rotation radius.
- Heavy round base for better stability and safety.
- Safe and environmentally friendly. Does not produce noise or odours.
- Includes accessories for anchoring the heater.

Área de calentamiento · Heating area

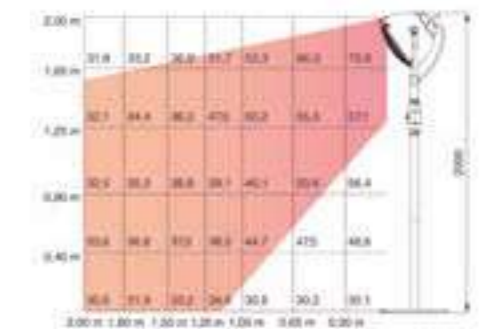

**Calentador eléctrico pie**  
Chauffage électrique sur pied · Standheizstrahler  
Free standing electric heater · Aquecedor eléctrico de pé

Ref	€	W	U.Venta
69414	454,90	2100	1

Ref	Tensión/Voltage	Potencia/Power	Lámparas Lamps	N. calentamiento Heating levels	Ángulo de giro Angle of rotation	Nivel protección Protection level	Dimensiones Sizes	Peso/Weight
69414	220-240 V ; 50/60 Hz	2100 W	2	3 (900/1200/2100W)	40°	IP54	45x45x210 cm	17,0 Kg

Área de calentamiento · Heating area



AL  
Aluminum

Inox

**Calentador pie**

Rechauffeur pied · Heizung m/Ausziehbarer Fuß  
Lamp · Aquecedor com pé

Ref	€	U.Venta
A 69410	343,90	1
B 69411	407,70	1

Ref	Tensión/Voltage	Potencia/Power	IP	Altura/Height	Cable/Cord	Calent./Heating	Dimensiones/Sizes	Peso/Weight
69410	220-240 V; 50/60 Hz	900/1200/2100 W	IP44	2,10 m	3,5 m	Lámpara calentamiento halógeno Halogen heating lamp	Ø58,5x1,6 - 2,10 m	13,35 Kg
69411	220-240 V; 50/60 Hz	1200/1800/3000 W	IP44	2,10 m	3,5 m		Ø76x2,10 m	14,40 Kg

Cadena de 1 m de longitud  
1 m long chain



Rejilla protectora  
Protective grill

### Lámpara calentadora de techo

Parasol chauffant électrique suspendu · Elektrischer Deckenheizstrahler  
Electric hanging lamp heater · Candeeiro aquecedor elétrico de teto

Ref	€	W	U.Venta
69422	209,80	2100	1

- Fácil de montar, incluye una cadena de 1 m de longitud para instalarla en el techo.
  - Cuenta con un control remoto para encender y apagar la lámpara calentadora.
  - Calor instantáneo, tiene 3 niveles de calentamiento (900 / 1200 / 2100 W).
  - Seguro y respetuoso con el medio ambiente, no produce ni ruidos ni olores.
- Facile à monter, il inclut une chaîne de 1 m de longueur pour l'installer au plafond.
- Dispose d'une télécommande pour allumer et éteindre le chauffage.
- Chaleur instantanée, dispose de 3 niveaux de chauffe (900 / 1200 / 2100 W).
- Sûr et respectueux de l'environnement, ne produit ni bruit ni odeurs.
- Easy to assemble. Includes a 1m chain for ceiling installation.
- The lamp heater has a remote control to turn it on and off.
- Instant heat. It has 3 heating levels (900 / 1200 / 2100 W).
- Safe and environmentally friendly. Does not produce noise or odours.

**NOTA: Para instalar el calentador tenga en cuenta las distancias mínimas de seguridad que aparecen en la imagen**  
NOTE: Be aware of the minimum safety distances shown in the image when installing the heater

Área de calentamiento · Heating area

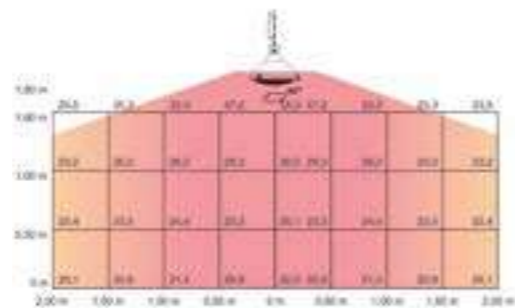

Ref	Tensión/Voltage	Potencia/Power	Lámparas Lamps	N. calentamiento Heating levels	Long. cadena Chain length	Nivel protección Protection level	Dimensiones Sizes	Peso/Weight
69422	220-240 V; 50/60 Hz	2100 W	2	3 (900/1200/2100W)	1,0 m	IP44	43x43x36 cm	3,15 Kg



Área de calentamiento · Heating area

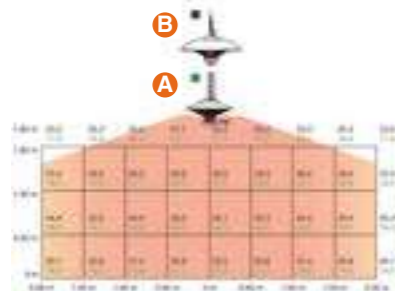

### Lámpara calentador

Lampe chauffe · Heizelement, freihängend  
Lamp 3 Lâmpada aquecedora

Ref	€	W	U.Venta
69420	175,90	1500	1
69421	236,90	900/1200/1500	1



Área de calentamiento · Heating area

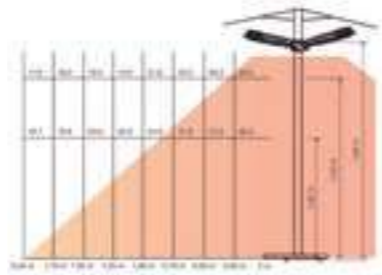

### Calent. brazos abatibles

Lampe chauffe bras rebatibles · Heizgerät Arme ausklappbar  
Heating lamp arms fold-away · Aquecedora braços rebatíveis

Ref	€	W	U.Venta
69423	234,00	2000	1

Ref	Tensión/Voltage	Potencia/Power	IP	Calent./Heating	Dimensiones/Sizes	Peso/Weight
69420	220-240 V; 50/60 Hz	1500 W	IP24	Lámp. calentamiento Halógeno infrarrojos	Ø42,5x25 cm	2,40 Kg
69421	220-240 V; 50/60 Hz	900/1200/2100 W	IP24	Halogen infrared heating lamp	Ø58,5x35 cm	2,75 Kg
69423	220-240 V; 50/60 Hz	2000 W	IP34	Halogen infrared heating lamp	Ø100x8,5 cm	3,60 Kg



Con control remoto  
With remote control

Soporte extendido  
Extended support



Área de calentamiento · Heating area

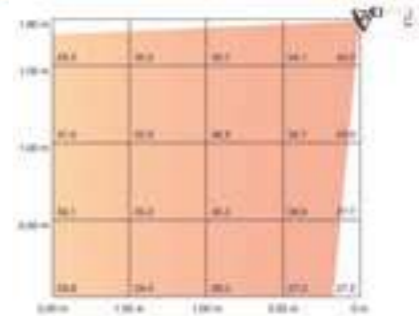

### Calentador de pared

Chauffe de mur · Heizung, Hängeleiste  
Wall lamp · Aquecedora de parede

Ref	€	W	U.Venta
69424	304,70	1500	1

Rejilla protectora  
Incluye un soporte de pared con regulación angular  
Cuerpo de aleación de aluminio anodizado  
Calefactor de fibra de carbono de alta eficiencia  
Protective grill  
Includes a wall bracket with angular adjustment  
Anodized aluminum alloy body.  
High Efficiency Carbon Fibre Heating



Con control remoto  
With remote control

AL  
Aluminum

ABS  
Plastic

### Calentador de pared

Chauffe de mur · Heizung, Hängeleiste  
Wall lamp · Aquecedora de parede

Ref	€	W	U.Venta
69425	201,30	1800	1
69426	236,30	2400	1

Ref	Tensión/Voltage	Potencia/Power	Lámparas Lamps	N. calentamiento Heating levels	Ángulo de giro Angle of rotation	Nivel protección Protection level	Dimensiones Sizes	Peso/Weight
69424	220-240 V; 50/60 Hz	1500 W	1	1	25° (eje vertical/vertical axis)	IP55	75x13x13cm	3,60 Kg
69425	220-240 V; 50/60 Hz	1800 W	1	1	25° (eje vertical/vertical axis)	IP65	65x21,5x24,5 cm	2,40 Kg
69426	220-240 V; 50/60 Hz	2400 W	1	1	25° (eje vertical/vertical axis)	IP65	85x22,5x26,5 cm	3,00 Kg

Accesorios · Accessoires · Accessories



Base con contrapeso  
Counterbalanced base

### Soporte para calentador

Support pour chauffe · Heizungshalterung  
Support for lamp · Suporte para aquecedora

Ref	€	Ø (cm)	h (cm)	U.Venta
69427	73,10	40	190	1



Solo para uso en exteriores · Only for outdoor use

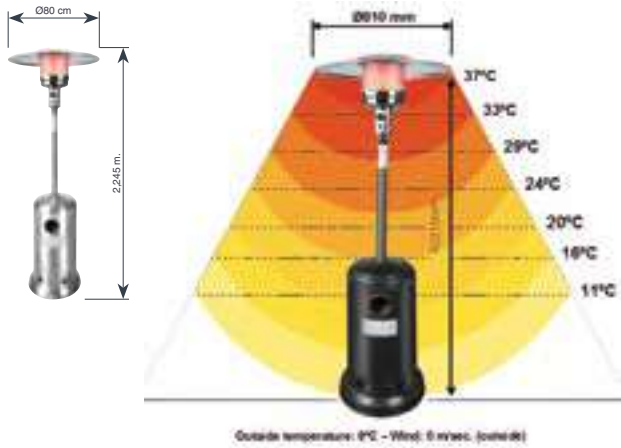

- Ideal para bares y restaurantes con mesas en el exterior.
- Indicado única y exclusivamente para exteriores.
- Disponible en dos acabados diferentes: acero inoxidable · negro.
- Malla protectora para evitar quemadura.

- Idéal pour les bars et les restaurants ayant des tables à l'extérieur.
- Destiné uniquement et exclusivement pour un usage en extérieur.
- Disponible en deux finitions différentes : acier inoxydable · noir.
- Maille de protection pour éviter les brûlures.

- Ideal for bars and restaurants with tables outside.
- Exclusively for outdoor use.
- Available in two different finishes: stainless steel · black.
- Protective mesh to prevent burns.

### Accesorios · Accessoires · Accessories



### Funda para calentador terraza a gas

Housse pour hauffage de terrasse à gaz · Abdeckung für Gas-Terrassenheizstrahler  
Cover for outdoor gas heater · Capa protectora para aquecedor a gás para terraços

Ref	€	U.Venta
R69400N	17,30	1



### Jgo. ruedas acero para calentador terraza

Ensemble de roves pour hauffage de terrasse à gaz · Rollen für Gas-Terrassenheizstrahler  
Wheel set for outdoor gas heater · Jogo de rodas para aquecedor a gás para terraços

	Ref	€	U.Venta
<b>A</b>	69400	393,10	1
<b>B</b>	69401	297,40	1

	Ref	€	U.Venta
<b>A</b>	R69400B	11,10	1
<b>B</b>	R69400R	11,10	1

Ref	Potencia/Power	Posición piloto/Pilot posit.	Altura/Height	Peso/Weight
69400	14 KW (max)	870 g/h	2,245 m	20 Kg
69401	14 KW (max)	870 g/h	2,245 m	22 Kg

Funciona con gas propano o butano · Uses propane or butane gas only