

2024

ristorazione hotelleria

LEONE dal 1945 a oggi

La nostra avventura inizia a Lugo di Romagna nel dopoguerra. Sono anni difficili dove poco o nulla è rimasto, il fondatore Luigi Tampieri insieme alla sua famiglia si rimbecca le maniche e fonda la Tampieri s.n.c. dove si producono stuzzicadenti ricavati dalla penna delle oche.

Nel 1970 Luigi lascia il posto al figlio Pietro, il nome della nostra azienda diventa Leone s.n.c.

Realizziamo le prime macchine automatiche per l'imbustamento degli stuzzicadenti e cominciamo a spedire le prime cartoline per corrispondenza ai ristoranti d'Italia.

Negli anni 80 creiamo i primi decori per la gelateria e la cartolina diventa un vero e proprio catalogo.

L'azienda attraverso idee innovative e sinergie con i clienti, cresce, diventando un punto di riferimento per il proprio settore. Sono gli anni 2000 che trasformano l'azienda in laboratorio di idee e sperimentazione spaziando nel mondo dell'ho.re.ca a 360 gradi. Curiosità intellettuali e scelte imprenditoriali coraggiose ci hanno portato a guardare il futuro con entusiasmo e non attraverso formule economiche o percentuali. L'innovazione, la sperimentazione, la comunicazione sono il cardine su cui si muove tutto il nostro lavoro. Mettiamo sempre in primo piano l'uomo e la sua dignità, perché coniugare gli obiettivi aziendali con le esigenze umane è il segreto della nostra impresa, ciò implica una forte responsabilità nei confronti della comunità e del pianeta.

Oggi come 79 anni fa amiamo quello che facciamo e continuiamo a farlo con passione.



Il nome della nostra azienda deriva da una piccola insegna sulla porta dove, un Leone con uno stuzzicadenti nella zampa, diceva "Adesso me li curo io", da lì, tutti cominciarono a chiamarli "gli stuzzicadenti del leone".

LEONE from 1945 till nowadays

Our business started in Lugo di Romagna during the second postwar period. These were very difficult years with very little resources and the founder, Mr. Luigi Tampieri with his family worked very hard to create Tampieri snc, that produced toothpicks from the goose feathers. In 1970 Mr. Luigi Tampieri was replaced by his son Pietro and the company name changed to Leone snc. We realized the first personalized packaging automatic machines and we started to send the marketing cards to all the restaurants in Italy.

In the 80's we designed the first decorations for ice cream parlours and the marketing card became the first real catalogue.

The company, thanks to the original ideas and the synergy with his customers, developed and became a benchmark for this sector.

During the 2000's the company turned to a real laboratory of ideas and tests which involved all the Ho.Re.ca product.

Our curiosity and courageous choices make us look at the future with enthusiasm; our work is principally based on innovation through research, love for environment and transparent communication. The ethic of the company is to care for each worker and his dignity, meeting the company targets and the human resource management. A strong responsibility that reflected in the community around us and the world.

Today, as 79 years ago, we love our work and we do it with passion.

A small sign on the company door, made by a good family friend, that shown a great Lion with a toothpick in his paw said "Now I take care of them!" From that moment in town, everybody called them "The Lion's toothpicks."



Oggi Leone è un'azienda leader di mercato certificata ISO 9001:2015, che può contare su un affiatato team di 60 collaboratori.

Lo stabilimento principale dispone di 10.000mq coperti che possono contenere oltre 15.000 pallets in grado di soddisfare qualunque tipo di fornitura.

Con una capillare rete commerciale e distributiva, siamo presenti oltre che in Italia in Europa e nel mondo



Today Leone is a market leader company, certified ISO 9001:2015, that relies on a trusty staff of 60 people.

The main factory has a 10.000 sq.m warehouse with more than 15.000 pallets, in order to guarantee any supply.

With a widespread sales network, we can sell in Italy as well as in Europe and Worldwide.



LEONE srl
sostiene il FAI,
Fondo
Ambiente
Italiano







un'esperienza italiana



Guida ai materiali

Bamboo

Ha caratteristiche eccezionali paragonabili ai migliori legni. Le sue canne crescono con velocità sorprendente (anche oltre un metro al giorno) fino alla loro altezza massima di 15-20 metri che raggiungono nel giro di un paio di mesi. Materiale incredibilmente resistente e durevole ma anche flessibile e leggero.

Legno

Gli articoli sono ricavati da piante di coltivazioni certificate e provenienti da foreste gestite in modo responsabile, seguendo rigorosi standard ambientali e sociali. Sono piante che crescono molto velocemente, infatti bastano 5 anni per ottenere una pianta pronta per essere lavorata. Il legno utilizzato si presta a svariati utilizzi in diverse tipologie di prodotto.



Foglia di palma

Raccolte durante il normale ciclo di rinnovamento, vengono trasformate mediante lavaggio e pressatura, in piatti e ciotole resistenti all'acqua e al calore che non alterano il gusto dei cibi. Adatti per cibi sia liquidi che solidi e per essere utilizzate in forno, microonde o freezer. Sono biodegradabili e compostabili.

Polpa di cellulosa

Si ricava dalle fibre della canna da zucchero. Prodotti idonei al contatto alimentare, possono essere utilizzati in forno e microonde (-10°/+120°C). Materiale completamente biodegradabile, rende più green il mondo dell'Ho.Re.Ca.

PLA

(-15°/+40°C) Polimero dell'acido lattico derivato da piante come il mais, il grano o la barbabietola prodotto attraverso un processo di fermentazione. Questi polimeri possono essere utilizzati per produrre resine simili alla plastica o fibre. È prodotto da risorse naturali rinnovabili annualmente. I prodotti sono totalmente compostabili in 8-12 settimane.

CPLA

Variante del comune PLA ricavato dal mais, in cui l'elemento base viene cristallizzato: ne deriva un risultato completamente naturale, che assicura totale compostabilità e biodegradabilità. Grazie a tale processo, la resistenza al calore aumenta, divenendo assolutamente più adatto all'utilizzo con cibi caldi.

Melamina

Questo materiale è una resina termoindurente utilizzata anche per la realizzazione di stoviglie e accessori per la tavola. Somigliante alla porcellana nell'aspetto, è leggera e resistente e ben apprezzata dai professionisti di settore per la sua praticità e per il design innovativo. Di facile pulizia e lavabile in lavastoviglie, sopporta temperature che arrivano fino a 70°C, può essere riposta in frigorifero e in freezer e non assorbe gli odori.



Materials guide

Bamboo

It has exceptional characteristics comparable to those of the best woods. Its reeds grow with surprising speed (about a meter a day) up to their maximum height of 15-20 meters that they reach within a couple of months. It is an incredibly hard and durable material but also flexible and light.

Wood

Our wooden products come from plants of certified cultivations and from forests that are responsibly managed in conformity with strict environmental, social and economic standards. The plants grow very fast and it may be enough 5 years to have a mature plant to work. The wood can be used in many kind of items.

Palm leaf

Naturally fall-off during the normal renewal cycle, they are converted in full plates and bowls through a washing and pressing process. The items are water and heat-resistant and they don't affect the taste of the food, they can contain liquid and solid food, it's can be used in traditional oven or microwave, and freezer. The items are biodegradable and compostable.

Cellulose pulp

(-10°/+120°C) It is obtained from the residual fibers of the processing in particular from sugar cane. Cellulose pulp products are suitable for food contact, heat resistant, they can be used in oven and microwave. Completely biodegradable, they make the Ho.re.Ca world more sustainable.

PLA

(-15°/+40° C) it is derived from renewable resources, such as corn starch, wheat or sugarcane. It is a bioplastic made from lactic acid and is used in the food industry to package sensitive food products. The products are totally compostable. Under optimal composting conditions, PLA products decompose in 8-12 weeks.



CPLA

Variant of the common PLA obtained from corn, where the basic element is crystallized: it derives a completely natural result, that ensures total compostability and biodegradability. Thanks to this process, the resistance to heat increases, becoming absolutely more suitable for use with hot foods.

Melamine

This material is a thermosetting resin and it is also used for creating kitchen utensils and tableware. It is very similar to porcelain; it is resistant and liked among professionals for its functionality and innovative design. Easy to clean and dishwasher safe, it can bear temperatures up to 70°C, it can be placed in the fridge or freezer and does not absorb odours.



Scheda tecnica dei materiali

Technical specification of materials

Tolleranza
termica
Thermal tolerance



Temp.
Max



Microonde
Microwave



Forno
Oven







Resistente
ad oli e grassi
Oil and greas
resistant



Biodegradabile
Biodegradable



Riciclabile
Recyclable

Material Code	Material Name	Thermal Tolerance	Temp. Max	Microwave	Oven	Gr	B	Rc
PE	Polietilene Polyethylene	-10° C +70° C	+70° C	✗	✗	✓	✗	✓
PP	Polipropilene Polypropylene	-10° C +70° C	+70° C	✗	✗	✓	✗	✓
PS	Polistirene cristallo Clear Polystyrene	-10° C +85° C	+70° C	✗	✗	✓	✗	✓
PC	Policarbonato Polycarbonate	-10° C +100° C	+70° C	✗	✗	✓	✗	✓
PVC	Polivinilcloruro Polyvinyl chloride	-10° C +70° C	+70° C	✗	✗	✓	✗	✓
MF	Melamina Melamine	-10° C +70° C	+70° C	✗	✗	✓	✗	✗
Tr	Tritan Tritan	-10° C +70° C	+70° C	✗	✗	✓	✗	✓
MA	Metacrilato Methacrylate	-10° C +85° C	+70° C	✗	✗	✓	✗	✓
PLA	Acido polilattico Polylactic acid PLA	 -20° C +40° C	+40° C	✗	✗	✓	✓	✓
CPLA	Acido polilattico cristallizzato Crystal Polylactic acid CPLA	 -40° C +90° C	+85° C	✓	✗	✓	✓	✓
Fe	Latta Enamel	0° C +200° C	+70° C	✗	✗	✓	✗	✓
W	Legno Wood	-20° C +100° C	+70° C	✗	✗	✓	✓	✓
Ac	Acrilico Acrylic	-5° C +70° C	+70° C	✗	✗	✓	✗	✓
Wp	Foglia di Palma Palm leaf	 -10° C +120° C	+70° C	✓	✓	✓	✓	✓
SL	Ardesia Slate	-5° C +70° C	+70° C	✗	✗	✓	✗	✗
CT	Cotone Cotton	/ / /	/	✗	✗	✗	✗	✗
Pa	Carta Paper	-10° C +70° C	+70° C	✗	✗	✓	✓	✓
TNT	Tessuto non tessuto Nonwoven	-12° C +22° C	+32° C	✗	✗	✓	✗	✗
PET	 Polietilene tereftalato Polyethylene Terephthalate	-0° C +70° C	+70° C	✗	✗	✓	✗	✓
SS	Acciaio Stainless steel	0° C +200° C	+70° C	✗	✗	✓	✗	✓
CEL	Polpa di cellulosa Cellulose pulp	-20° C +120° C	+70° C	✓	✓	✓	✓	✓
SW	Grès Stoneware	-20° C +160° C	+70° C	✓	✓	✓	✗	✗
GI	Vetro Glass Borosilicate	-30° C +300° C	+ 80° C	✓	✓	✓	✗	✓

Temperatura max prodotto. Regolamento 1935/2004 (Contatto alimentare) Max temp. Regulation 1935/2004 (Food contact)
I dati riportati sono a puro scopo indicativo, si raccomanda di verificare l'idoneità tecnologica nell'applicazione reale in base ai tempi e alle temperature d'impiego.

INFORMAZIONI SU ARTICOLI DESTINATI AL CONTATTO CON PRODOTTI ALIMENTARI

- I prodotti presenti sul Catalogo LEONE che, per loro natura, siano destinati a venire a contatto con alimenti sono conformi al regolamento UE 1935/2004 del 27/10/2004, reg. 2023/2006 del 22/12/2006;
- La ditta Leone adotta inoltre una procedura comprensiva di tutti gli aspetti previsti ai fini della rintracciabilità che:
- consente l'eventuale esclusione dei prodotti non idonei all'immissione sul mercato;
- dispone di un elenco aggiornato e dettagliato dei fornitori e dei clienti;
- prevede una serie di registrazioni in grado di risalire al destinatario di ciascun prodotto immesso sul mercato.

INFORMATION ON ARTICLES INTENDED TO COME INTO CONTACT WITH FOODSTUFFS

- *Products on LEONE's catalog, which by their nature, are intended to come into contact with food shall comply with the UE regulation 1935/2004 of 27/10/2004, reg- 2023/2006 of 22/12/2006;*
- *LEONE also adopts a procedure which encompasses all aspects planned for the immediate recognition that :*
- *Allows the possible exclusion of products not suitable for marketing.*
- *Has a detailed and updated list of suppliers and customers.*
- *Provides a series of records that can trace the recipient of each product on the market.*

INFORMAZIONI SUI PRODOTTI COSMETICI

Salviette umidificate, Saponi, Bagnodoccia, Shampoo, Dentifrici, Crema da barba, Body lotion.

- Reparto di Produzione e Confezionamento: struttura a norma di legge e conforme ai parametri igienico sanitari così come previsti dal DM 328/87.
- Impianti di produzione: automatizzati e certificati per l'uso cosmetico.
- Adeguamento al Regolamento cosmetico 1223/09 con attuazione delle disposizioni GMP (Uni 22716) e predisposizione dei PIF (Product Information File) (completo di CPSR, Cosmetic Product Safety Report, CPSA, Cosmetic Product Safety Assessment).

INFORMATION ON COSMETIC PRODUCTS

Refreshing towelette, Soap, Bath foam, Toothpaste, Shaving cream, Body lotion.

- Production factory and packaging: structure complying with the law and with health and hygiene standards as provided by DM 328/87.
- Production Plants: automated and certified for cosmetic use.
- Adaptation to EC Regulation cosmetic 1223/09 with implementation of the GMP (Uni 22716) and preparation of the PIF (Product Information File) (complete CPSR, Cosmetic Product Safety Report, CPSA, Cosmetic Product Safety Assessment)

modalità d'uso • use



Lavaggio in lavastoviglie
Dishwasher safe



Non usare lame
Not scratch-proof



Lavare a mano
Handwash



Misure Gastronorm
Gastronorm size



Adatto per forno
Oven-proof



Non usare su fornelli
No flame



Non usare in forno
Not in oven



Utilizzabile su fornelli
Flame ok



Adatto per congelatore
Freezer-proof



Adatto per microonde
Microwavable



Non adatto per microonde
Not microwavable



Infrangibile
Unbreakable

avvertenze • notice



Ad esaurimento scorte
Until sold out



Personalizzabile
Customizable
pag. 298



Novità Leone
Leone novelties



Info Leone
Leone info



12-71

melamina
melamine



154-157

secchielli e caraffe
ice buckets and jugs



72-73

scaldavivande acciaio
steel chafing dishes



158-159

calici e bicchieri
wine and water glasses

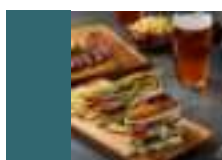

74-95

acacia, buffet e taglieri
acacia, buffet, cutboards



160-163

accessori in latta
tin accessories



96-121

bamboo, buffet e taglieri
bamboo, buffet, cutboards

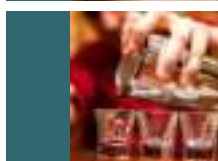

164-169

accessori barman
barman accessories



122-123

ceramica
ceramic



170-173

portatovaglioli e accessori
sachet holders and table bins

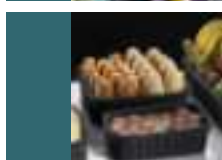

124-133

cestini
baskets



174-175

guanti forno e grembiuli
aprons and oven mitts



134-135

bancalini e cassette
mini pallets and boxes



176-177

macina sale e pepe
salt and pepper mills



136-139

carta antigrasso
grease proof paper

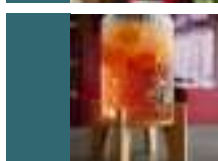

178-181

vetro, jar e vasetti
glass, jars & accessories



140-144

cestelli e pentolini acciaio
stainless steel pans and baskets



182-187

tovaglette e runner
tablemats and runners

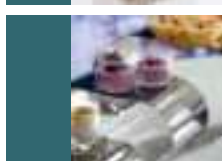

145-153

acciaio martellato
hammered steel



188-191

menu e comande
menu holders



192-197
lavagne e pennarelli
 blackboards and pens



198-199
candele e accessori
 candles and accessories



200-201
accessori pasticceria
 pastry accessories



202-207
finger food naturale
 natural finger food



208-209
cannucce bio
 straws



210-217
spiedi e stuzzicadenti
 sticks and toothpicks



218-221
monouso in legno
 wood disposable items



222-223
foglia di palma
 palm leaf

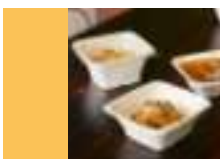

224-239
polpa di cellulosa
 cellulose pulp

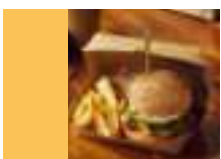

240-253
take away & street food
 take away & street food



254-259
monouso compostabile
 compostable disposable

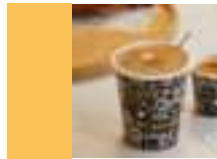

260-265
bicchieri monouso
 disposable cups



266-269
sottobicchieri e pizzi
 coasters and paper doilies



270-271
portaposate e tovagliette
 cutlery holders & placemats



272-274
salviette umidificate
 wet wipes



275
bavaglioni & cappelli cuoco
 bibs & chef hats

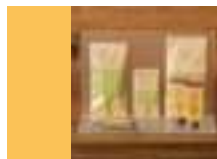

276-292
linea cortesia hotel
 amenities for hotel

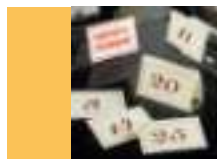

293-295
espositori plexiglass
 plexiglass display stands



296-297
outlet
 outlet



301-307
elenco prodotti
 items list





CATALOGO 2024





€ 2,84  

T8691 | ciotolina | *small bowl*
cm Ø9,4x4 | pz. conf. 1 | c/c 36



€ 5,56  

T8686 | ciotola | *bowl*
cm Ø14,5x14,2x7 | pz. conf. 1 | c/c 24



€ 9,20  

T8684 | piatto | *plate*
cm Ø23,5x2,5 | pz. conf. 1 | c/c 12



€ 11,84  

T8685 | piatto | *plate*
cm Ø27x2,5 | pz. conf. 1 | c/c 12



€ 5,72  

T8689 | piatto fondo | *soup plate*
cm Ø18,5x4 | pz. conf. 1 | c/c 12



€ 11,32  

T8690 | piatto fondo | *soup plate*
cm Ø24x5 | pz. conf. 1 | c/c 12





€ 12,80



T8682 | ciotola triangolare | *triangle bowl*
cm 23,5x6 | pz. conf. 1 | c/c 12



€ 8,00



T8683 | ciotola triangolare | *triangle bowl*
cm 18,5x6 | pz. conf. 1 | c/c 12



€ 11,44



T8680 | piatto triangolare | *triangle plate*
cm 26,5x2,5 | pz. conf. 1 | c/c 12



€ 4,80



T8681 | piatto triangolare | *triangle plate*
cm 19,2x2,5 | pz. conf. 1 | c/c 24



€ 7,20



T8687 | piatto rettangolare | *rectangular plate*
cm 23,5x15x2,5 | pz. conf. 1 | c/c 18



€ 13,84



T8688 | piatto rettangolare | *rectangular plate*
cm 29,5x15x2,5 | pz. conf. 1 | c/c 8





€ 2,84



T8671 | ciotolina | *small bowl*
cm Ø9,4x4 | pz. conf. 1 | c/c 36



€ 5,56



T8666 | ciotola | *bowl*
cm Ø14,5x14,2x7 | pz. conf. 1 | c/c 24



€ 9,20



T8664 | piatto | *plate*
cm Ø23,5x2,5 | pz. conf. 1 | c/c 12



€ 11,84



T8665 | piatto | *plate*
cm Ø27x2,5 | pz. conf. 1 | c/c 12



€ 5,72



T8669 | piatto fondo | *soup plate*
cm Ø18,5x4 | pz. conf. 1 | c/c 12



€ 11,32



T8670 | piatto fondo | *soup plate*
cm Ø24x5 | pz. conf. 1 | c/c 12





€ 12,80



T8662 | ciotola triangolare | *triangle bowl*
cm 23,5x6 | z. conf. 1 | c/c 12



€ 8,00



T8663 | ciotola triangolare | *triangle bowl*
cm 18,5x6 | pz. conf. 1 | c/c 12



€ 11,44



T8660 | piatto triangolare | *triangle plate*
cm 26,5x2,5 | pz. conf. 1 | c/c 12



€ 4,80



T8661 | piatto triangolare | *triangle plate*
cm 19,2x2,5 | pz. conf. 1 | c/c 24



€ 7,20



T8667 | piatto rettangolare | *rectangular plate*
cm 23,5x15x2,5 | pz. conf. 1 | c/c 18



€ 13,84



T8668 | piatto rettangolare | *rectangular plate*
cm 29,5x15x2,5 | pz. conf. 1 | c/c 8





€ 17,38



T8526.Q | ciotola verde | *green bowl*
cm Ø19,6x9,5 | pz. conf. 1 | c/c 12



€ 15,68



T8527.Q | ciotola verde | *green bowl*
cm Ø17,9x8,5 | pz. conf. 1 | c/c 12



€ 17,38



T8526.Z | ciotola nera | *black bowl*
cm Ø19,6x9,5 | pz. conf. 1 | c/c 12



€ 15,68



T8527.Z | ciotola nera | *black bowl*
cm Ø17,9x8,5 | pz. conf. 1 | c/c 12



€ 17,38



T8526.Y | ciotola bianca | *white bowl*
cm Ø19,6x9,5 | pz. conf. 1 | c/c 12



€ 15,68



T8527.Y | ciotola bianca | *white bowl*
cm Ø17,9x8,5 | pz. conf. 1 | c/c 12



pokè



€ 3,96



T8645 | piatto corfù | *plate corfù* |
cm Ø18x1,8 | pz. conf. 1 | c/c 36



€ 6,60



T8643 | ciotola decorata | *decorated bowl* |
cm Ø20,5x5,5 | pz. conf. 1 | c/c 24



€ 5,01



T8640 | piatto decorato | *decorated plate* |
cm Ø21,5x2 | pz. conf. 1 | c/c 36



€ 4,95



T8646 | piatto corfù | *plate corfù* |
cm 17x17x2 | pz. conf. 1 | c/c 24



€ 6,60



T8641 | piatto decorato | *decorated plate* |
cm Ø26,5x2 | pz. conf. 1 | c/c 24



€ 15,68



T8644 | ciotola decorata | *decorated bowl* |
cm Ø30x9 | pz. conf. 1 | c/c 12



€ 13,15



T8642 | piatto decorato | *decorated plate* |
cm Ø35,5x3 | pz. conf. 1 | c/c 12



corfù



€ 3,96



T8635 | piatto zante | *plate zante* |
cm Ø18x1,8 | pz. conf. 1 | c/c 36



€ 6,60



T8633 | ciotola decorata | *decorated bowl* |
cm Ø20,5x5,5 | pz. conf. 1 | c/c 24



€ 5,01



T8630 | piatto decorato | *decorated plate* |
cm Ø21,5x2 | pz. conf. 1 | c/c 36



€ 4,95



T8636 | piatto zante | *plate zante* |
cm 17x17x2 | pz. conf. 1 | c/c 24



€ 6,60



T8631 | piatto decorato | *decorated plate* |
cm Ø26,5x2 | pz. conf. 1 | c/c 24



€ 15,68



T8634 | ciotola decorata | *decorated bowl* |
cm Ø30x9 | pz. conf. 1 | c/c 12



€ 13,15



T8632 | piatto decorato | *decorated plate* |
cm Ø35,5x3 | pz. conf. 1 | c/c 12



zante



€ 6,60



T8653 | ciotola decorata | decorated bowl
cm Ø20,5x5,5 | pz. conf. 1 | c/c 24



€ 3,96



T8655 | piatto itaca | plate itaca |
cm Ø18x1,8 | pz. conf. 1 | c/c 36



€ 4,95



T8656 | piatto itaca | plate itaca |
cm 17x17x2 | pz. conf. 1 | c/c 24



€ 5,01



T8650 | piatto decorato | decorated plate
cm Ø21,5x2 | pz. conf. 1 | c/c 36



€ 6,60



T8651 | piatto decorato | decorated plate
cm Ø26,5x2 | pz. conf. 1 | c/c 24



€ 15,68



T8654 | ciotola decorata | decorated bowl
cm Ø30x9 | pz. conf. 1 | c/c 12



€ 13,15



T8652 | piatto decorato | decorated plate
cm Ø35,5x3 | pz. conf. 1 | c/c 12





terracotta



€ 7,52



T8230 | ciotola tonda | *round bowl*
cm Ø 18,4x7,5 | pz. conf. 1 | c/c 18



€ 5,19



T8234 | coppetta tonda | *round bowl*
cm Ø 14,7x5,5 | pz. conf. 1 | c/c 24



€ 10,63



T8231 | ciotola tonda | *round bowl*
cm Ø 20,3x8,5 | pz. conf. 1 | c/c 12



€ 3,90



T8236 | coppetta tonda | *round bowl*
cm Ø 11,7x3,6 | pz. conf. 1 | c/c 32



€ 13,46



T8232 | ciotola tonda | *round bowl*
cm Ø 23,3x9,7 | pz. conf. 1 | c/c 12



€ 6,73



T8237 | coppetta tonda | *round bowl*
cm Ø 15,3x4,3 | pz. conf. 1 | c/c 18





€ 11,31



T8623 | piatto decorato | *decorated plate*
cm 26,5x20,8x2,7 | pz. conf. 1 | c/c 12



ibiza



€ 8,95



T8620 | piatto decorato | *decorated plate*
cm 20,8x20x3,8 | pz. conf. 1 | c/c 12



€ 5,49



T8622 | piatto decorato | *decorated plate*
cm 22,4x15,5x2 | pz. conf. 1 | c/c 12



€ 7,85



T8621 | piatto decorato | *decorated plate*
cm 25,6x15,7x3,4 | pz. conf. 1 | c/c 12





€ 10,29



T8515.T | ciotola grigio-bianco | *grey-white bowl* | cm Ø 22,8x8,3 | pz. conf. 1 | c/c 24



€ 10,29



T8515.G | ciotola giallo-bianco | *yellow-white bowl* | cm Ø 22,8x8,3 | pz. conf. 1 | c/c 24



€ 10,29



T8515.I | ciotola blu-bianco | *blue-white bowl* | cm Ø 22,8x8,3 | pz. conf. 1 | c/c 24



€ 4,65



T8516 | vaschetta rettang. | *rectangular tray* | cm 22x15x3,5 | pz. conf. 1 | c/c 16



€ 4,90



T8517 | vaschetta quadrata | *square tray* | cm 15x15x6 | pz. conf. 1 | c/c 16





€ 9,93



T8505 | ciotola tonda | round bowl
cm Ø 21,6x7,6 | pz. conf. 1 | c/c 24



€ 5,85



T8508 | piatto tondo | round dish
cm Ø 21,5x5,5 | pz. conf. 1 | c/c 36



€ 3,33



T8504 | ciotola tonda | round bowl
cm Ø 14x5,5 | pz. conf. 1 | c/c 48





€ 2,59



T8506 | ciotola tonda | round bowl
cm Ø 11,5x4 | pz. conf. 1 | c/c 48



€ 3,44



T8531 | ciotola | bowl
cm Ø 12,7x4,5 | pz. conf. 1 | c/c 36



€ 1,43



T8511 | cucchiaino | spoon
cm 15,3x4,7x5 | pz. conf. 1 | c/c 96



€ 1,34



T8513 | coppetta ovale | small bowl
cm 10,3x8,9x5 | pz. conf. 1 | c/c 48



€ 2,46



T8534 | tris ciotolina quadrata | *square bowl set* | cm 17,5x6,5x2,8 | pz. conf. 1 | c/c 36



€ 2,34



T8509 | piatto ovale | *oval dish* | cm 18x10x3,5 | pz. conf. 1 | c/c 48



€ 1,80



T8533 | bis ciotolina quadrata | *square bowl set* | cm 11,5x6,5x2,8 | pz. conf. 1 | c/c 48



€ 3,63



T8510 | piatto ovale | *oval dish* | cm 25x13,6x4,3 | pz. conf. 1 | c/c 24



€ 4,95



T8500 | vassoio quadrato | *square tray* | cm 17x17x1,8 | pz. conf. 1 | c/c 24



€ 4,23



T8502 | piatto ovale | *oval dish* | cm 25x15x1,8 | pz. conf. 1 | c/c 36



€ 7,57



T8501 | vassoio rettangolare | *rectangular tray* | cm 27,4x14,3x2,2 | pz. conf. 1 | c/c 24



€ 9,97



T8503 | piatto ovale | *oval dish* | cm 35x24,8x1,6 | pz. conf. 1 | c/c 18







€ 1,15



T8181 | coppetta bianca | *white bowl*
cm Ø9x2,4 | pz. conf. 1 | c/c 84



€ 1,11



T8110 | piattino rettangolare | *rectangular small dish*
cm 9,5x6x3 | pz. conf. 1 | c/c 48



€ 1,78



T8183 | ciotolina bianca | *white cup*
cm Ø9,3x5 | pz. conf. 1 | c/c 48



€ 1,87



T8182 | coppetta bianca | *white cup*
cm 9,4x7,5x4 | pz. conf. 1 | c/c 48



€ 5,75



T8446 | vassoio rettangolare | *rectangular tray*
cm 28x9x4 | pz. conf. 1 | c/c 24



€ 1,84



T8179 | ciotola quadrata | *square bowl*
cm 9,7x9,7x3,5 | pz. conf. 1 | c/c 30



€ 1,25



T8175 | ciotolina Candy | *small bowl Candy*
cm Ø 7x3,7 | pz. conf. 1 | c/c 120



€ 1,56



T8100 | coppetta bianca | *white small cup*
cm 10x9x5 | pz. conf. 1 | c/c 48





€ 5,34  
 

T8104 | coppa a goccia | *drop cup*
cm Ø 20x15x7,5 | pz. conf. 1 | c/c 24



€ 3,34  
 

T8156 | ciotola quadrata | *square bowl*
cm 11,5x14x4 | pz. conf. 1 | c/c 48



€ 1,89  
 

T8101 | coppetta bianca | *white small cup*
cm 15x12,5x5 | pz. conf. 1 | c/c 48



€ 2,23  
 

T8109 | coppetta bianca | *white small cup*
cm Ø 11x5,6 | pz. conf. 1 | c/c 48



€ 4,59  
 

T8155 | ciotola doppia | *double cup*
cm 24x8x4,3 | pz. conf. 1 | c/c 36



€ 1,61



T8171 | coppetta bianca | *white small cup*
cm 13x11,5x4,5 | pz. conf. 1 | c/c 72



€ 2,25



T8115 | ciotola rettangolare | *rectangular bowl*
cm 15,5x11x5 | pz. conf. 1 | c/c 48



€ 1,78



T8176 | piattino Wipe | *small plate Wipe*
cm 16x6,3x2,7 | pz. conf. 1 | c/c 100



€ 2,46



T8184 | ciotola bianca | *white bowl*
cm Ø11,5x5,7 | pz. conf. 1 | c/c 48



€ 1,78



T8111 | coppetta quadrata | *square small cup*
cm 8,5x8,5x4,5 | pz. conf. 1 | c/c 48



€ 5,13



T8113 | coppetta 3 scomparti | *triple cup*
cm 24,5x8,5x5 | pz. conf. 1 | c/c 36



€ 3,55



T8007 | vaschetta acquamarina | *acquamarina bowl*
cm 22x7x2,5 | pz. conf. 1 | c/c 48



€ 3,45



T8112 | coppetta 2 scomparti | *double cup*
cm 16x8,5x5 | pz. conf. 1 | c/c 48





€ 7,56



T8195.Z | poggiaposate nero | *black cutlery holder* | cm 8x2x1 | pz. conf. 6 | c/c 20



€ 7,56



T8195.T | poggiaposate grigio | *gray cutlery holder* | cm 8x2x1 | pz. conf. 6 | c/c 20



€ 7,56



T8195 | poggiaposate bianco | *white cutlery holder* | cm 8x2x1 | pz. conf. 6 | c/c 20



€ 8,33



T8196 | Piatto a 5 scomparti | *5 compartments plate* cm 23x21x1,5 | pz. conf. 1 | c/c 24



T8185

bicchierino | *small cup*
cm Ø6,5x7 | pz. conf. 1 | c/c 60

T8185.Z

€ 2,61



T8186

bicchierino | *small cup*
cm 6x6x8 | pz. conf. 1 | c/c 60

T8186.Z

€ 2,61



T8187

coppetta quadrata | *square cup*
cm 6,5x6,5x5,5 | pz. conf. 1 | c/c 60

T8187.Z

€ 2,61



T8188

coppetta quadrata | *square cup*
cm 8x8x6,3 | pz. conf. 1 | c/c 60

T8188.Z

€ 2,61



T8189

bicchierino | *small cup*
cm Ø7x6,3 | pz. conf. 1 | c/c 60

T8189.Z

€ 2,61



T8194

bicchierino | *small cup*
cm 7,9x7,3x7 | pz. conf. 1 | c/c 60

T8194.Z

€ 2,61



T8190

foglia | *leaf*
cm 10,5x4,5x2,2 | pz. conf. 1 | c/c 60

T8190.Z

€ 1,51



T8193

Piattino triangolare | *small triangular dish*
cm 6,9x1,5 | pz. conf. 1 | c/c 60

T8193.Z

€ 1,51



T8191

piattino quadrato | *small square dish*
cm 8x8x1,3 | pz. conf. 1 | c/c 60

T8191.Z

€ 1,51



T8192

piattino quadrato | *small square dish*
cm 12x12x1,3 | pz. conf. 1 | c/c 60

T8192.Z

€ 2,61





T8165

ciotolina goccia | *drop-shaped bowl*
cm Ø 10x6,5x2,4 | pz. conf. 1 | c/c 96

T8165.Z

€ 1,51



T8164

ciotolina tonda | *round bowl*
cm Ø 7x3,5 | pz. conf. 1 | c/c 60

T8164.Z

€ 1,51



T8163

ciotolina quadrata | *square bowl*
cm 7,5x7,5x2,7 | pz. conf. 1 | c/c 96

T8163.Z

€ 1,51



T8166

cucchiaio | *spoon*
cm 14,5x4,5x1,5 | pz. conf. 1 | c/c 96

T8166.Z

€ 1,51





€ 10,47



T8142 | vassoio rettangolare | *rectangular tray* | cm 33x20x2,5 | pz. conf. 1 | c/c 18



€ 9,47



T8136 | vassoio rettangolare | *rectangular tray* | cm 30x18x2,5 | pz. conf. 1 | c/c 18



€ 14,20



T8143 | vassoio rettangolare | *rectangular tray* | cm 38x23x3 | pz. conf. 1 | c/c 12



€ 15,65



T8137 | vassoio rettangolare | *rectangular tray* | cm 36x21x2,5 | pz. conf. 1 | c/c 12



€ 21,45



T8144 | vassoio rettangolare | *rectangular tray* | cm 44x27x3 | pz. conf. 1 | c/c 6



€ 9,35



T8135 | vassoio rettangolare | *rectangular tray* | cm 36x11,5x2,5 | pz. conf. 1 | c/c 12



€ 7,30



T8158 | piatto rettangolare | *rectangular dish* | cm 28,6x18x2,8 | pz. conf. 1 | c/c 18



€ 4,90



T8157 | piatto rettangolare | *rectangular dish* | cm 23x14x2,6 | pz. conf. 1 | c/c 24





€ 5,18



T8159 | vassoio rettangolare | *rectangular tray* | cm 31x8,2x3,3 | pz. conf. 1 | c/c 24



€ 3,65



T8162 | vassoio doppio | *double tray* | cm 29x14,5x3 | pz. conf. 1 | c/c 18



€ 3,11



T8120 | salsiera bianca | *white sauce boat* | cm 21x7x4,5 | pz. conf. 1 | c/c 48



€ 3,23



T8121 | piatto ovale | *oval plate* | cm 28x10x4 | pz. conf. 1 | c/c 36



€ 8,68



T8124 | piatto salsiera | *sauce boat plate* | cm 30x15x5,5 | pz. conf. 1 | c/c 18



€ 7,02



T8134 | vassoio rettangolare | *rectangular tray* | cm 27x12x2,5 | pz. conf. 1 | c/c 18





€ 4,03



T8130 | vassoio rettangolare | *rectangular*
tray | cm 24x10x2 | pz. conf. 1 | c/c 24



€ 8,68



T8132 | vassoio rettangolare | *rectangular*
tray | cm 32x12x2 | pz. conf. 1 | c/c 12



€ 6,13



T8131 | vassoio rettangolare | *rectangular*
tray | cm 33x12x2 | pz. conf. 1 | c/c 18



€ 9,92



T8133 | vassoio rettangolare | *rectangular*
tray | cm 37x11x2,5 | pz. conf. 1 | c/c 12



€ 4,95



T8428 | piatto quadrato | *square plate* |
cm 17x17x2 | pz. conf. 1 | c/c 24



€ 12,03



T8126 | piatto rotondo | *round dish* |
cm Ø 30x6 | pz. conf. 1 | c/c 12



€ 6,47



T8180 | piatto pesce | *fish-shaped plate* |
cm 38x22x3 | pz. conf. 1 | c/c 18



€ 6,46



T8161 | piatto con salsiera | *dish sauce holder* |
cm 33x17,5x3,2 | pz. conf. 1 | c/c 24



€ 13,12



T8448 | piatto bianco | *white plate* |
cm Ø24x4,5 | pz. conf. 1 | c/c 12



€ 8,17



T8447 | piatto bianco | *white plate* |
cm Ø20,5x4,8 | pz. conf. 1 | c/c 18





€ 2,03



T8169 | piatto piano | *flat dish*
cm Ø 20x2 | pz. conf. 1 | c/c 60



€ 2,39



T8167 | piatto piano | *flat dish*
cm Ø 23x2 | pz. conf. 1 | c/c 60



€ 2,26



T8168 | piatto fondo | *soup dish*
cm Ø 21x4 | pz. conf. 1 | c/c 60



€ 4,64



T8119 | piatto ovale | *oval dish*
cm 32x16,5x6 | pz. conf. 1 | c/c 36



€ 2,71



T8102 | piatto fondo | *deep plate*
cm Ø 17,5x6 | pz. conf. 1 | c/c 48



€ 3,68



T8103 | piatto fondo | *deep plate*
cm Ø 20x6,5 | pz. conf. 1 | c/c 48





€ 4,56



T8128 | ciotola quadrata | *square bowl*
cm 18x18x6 | pz. conf. 1 | c/c 36



€ 6,85



T8129 | ciotola quadrata | *square bowl*
cm 21x21x7 | pz. conf. 1 | c/c 24



€ 4,01



T8105 | ciotola rettangolare | *rectangular bowl*
cm 17x13x6 | pz. conf. 1 | c/c 48



€ 9,47



T8106 | ciotola rettangolare | *rectangular bowl*
cm 25x20x9 | pz. conf. 1 | c/c 24



€ 10,47



T8122 | piatto ovale | *white oval dish*
cm 33,5x20x6 | pz. conf. 1 | c/c 18



€ 4,43



T8118 | vaschetta rettangolare | *rectangular tray*
cm 25,6x9x4 | pz. conf. 1 | c/c 36





€ 4,34



T8173 | tazza bianca | *white cup*
cm Ø 8,5x10 | pz. conf. 1 | c/c 24



€ 3,01



T8107 | ciotola cilindrica | *cylindrical bowl*
cm Ø 11x10 | pz. conf. 1 | c/c 48



€ 2,37



T8177 | ciotola Moon | *round bowl Moon*
cm Ø 15x7,4 | pz. conf. 1 | c/c 60



€ 4,79



T8108 | ciotola cilindrica | *cylindrical bowl*
cm Ø 14x10 | pz. conf. 1 | c/c 36



€ 1,67



T8036 | bicchiere melamina | *melamine cup*
cm Ø 7,5x11 | 300ml | pz. conf. 1 | c/c 24



€ 1,61



T8138 | cucchiaino bianco | *white spoon*
cm 26,5 | pz. conf. 1 | c/c 48





€ 15,11



T8178 | ciotola Moon | *round bowl Moon*
cm Ø 30x7,4 | pz. conf. 1 | c/c 12



€ 17,15



T8147 | insalatiera bianca | *white salad bowl*
cm Ø 40x6 | pz. conf. 1 | c/c 12



€ 13,93



T8148 | insalatiera bianca | *white salad bowl*
cm Ø 36x11 | pz. conf. 1 | c/c 12



16,38



T8153 | vassoio rettang. | *rectangular tray*
cm 57x17x2,5 | pz. conf. 1 | c/c 6



€ 15,82



T8150 | piatto piano | *flat plate*
cm Ø 40x3,5 | pz. conf. 1 | c/c 12





€ 18,27

T8140 | vassoio quadrato | *square tray*
cm 30x30x4 | pz. conf. 1 | c/c 8



€ 79,84

T8151 | vassoio conchiglia | *shell tray*
cm 55x28x17 | pz. conf. 1 | c/c 2



€ 19,21

T8141 | piatto design | *design dish*
cm 29x29x5,5 | pz. conf. 1 | c/c 12



vassoio rettangolare | *rectangular tray*
T8403 | cm 25x35x7,5 | pz. conf. 1 | c/c 6 € 23,80
T8402 | cm 45x30x7,5 | pz. conf. 1 | c/c 12 € 25,51



vassoio rettangolare | *rectangular tray*
T8404 | cm 25x15x7,5 | pz. conf. 1 | c/c 12 € 10,70
T8401 | cm 50x20x7,5 | pz. conf. 1 | c/c 6 € 24,17



€ 18,66



T8149 | vassoio ovale | oval tray
cm 60x23x4 | pz. conf. 1 | c/c 6



€ 14,59



T8145 | vassoio ovale | oval tray
cm 45x21x5 | pz. conf. 1 | c/c 12



€ 22,58



T8436 | vassoio ovale | oval tray
cm 60x30x1,6 | pz. conf. 1 | c/c 6



€ 14,18



T8435 | vassoio ovale | oval tray
cm 45x25x1,6 | pz. conf. 1 | c/c 8



€ 33,31



T8170 | vassoio ovale | oval tray
cm 69x29x6,3 | pz. conf. 1 | c/c 6



€ 17,49



T8146 | vassoio ovale | oval tray
cm 49,5x23x5 | pz. conf. 1 | c/c 12



€ 27,50



T8439 | vassoio ovale | oval tray
cm 60x30x6,5 | pz. conf. 1 | c/c 4



€ 26,04



T8438 | vassoio ovale | oval tray
cm 45x25x6,5 | pz. conf. 1 | c/c 4





€ 9,31



T8020.Z | vassoio nero | black tray | cm 35x24x2,3 | pz. conf. 1 | c/c 12



€ 6,63



T8019.Z | vassoio nero | black tray | cm 30x20x2 | pz. conf. 1 | c/c 12



€ 9,31



T8020 | vassoio bianco | white tray | cm 35x24x2,3 | pz. conf. 1 | c/c 12



€ 6,63



T8019 | vassoio bianco | white tray | cm 30x20x2 | pz. conf. 1 | c/c 12



€ 17,08



T0553 | coperchio rotondo | round cover | cm Ø 30,5x14 | pz. conf. 1 | c/c 12



€ 17,69
€ 25,91



tortiera bianca | white cake holder
T8154 | cm Ø 30x10 | pz. conf. 1 | c/c 6
T8154.L | cm Ø 35x10 | pz. conf. 1 | c/c 6





€ 4,73



T8521.Y | vassoio bigné | *bigné tray*
cm 26,5x16,2 | pz. conf. 1 | c/c 24



€ 3,11



T8522.Y | vassoio bigné | *bigné tray*
cm 17,5x11 | pz. conf. 1 | c/c 36



€ 11,64



T8525.Y | vassoio bigné | *bigné tray*
cm 26,5x32,5 | pz. conf. 1 | c/c 12



€ 9,08



T8524.Y | vassoio bigné | *bigné tray*
cm 20,5x31 | pz. conf. 1 | c/c 12





€ 9,72



T8440.Z | insalatiera quadrata | *square bowl*
cm 17,7x17,7x8,3 | pz. conf. 1 | c/c 24



€ 9,72



T8440 | insalatiera quadrata | *square bowl*
cm 17,7x17,7x8,3 | pz. conf. 1 | c/c 24



€ 17,93



T8441.Z | insalatiera quadrata | *square bowl*
cm 24x24x10 | pz. conf. 1 | c/c 12



€ 17,93



T8441 | insalatiera quadrata | *square bowl*
cm 24x24x10 | pz. conf. 1 | c/c 12



€ 28,88



T8442.Z | insalatiera quadrata | *square bowl*
cm 30x30x11,5 | pz. conf. 1 | c/c 6



€ 28,88



T8442 | insalatiera quadrata | *square bowl*
cm 30x30x11,5 | pz. conf. 1 | c/c 6



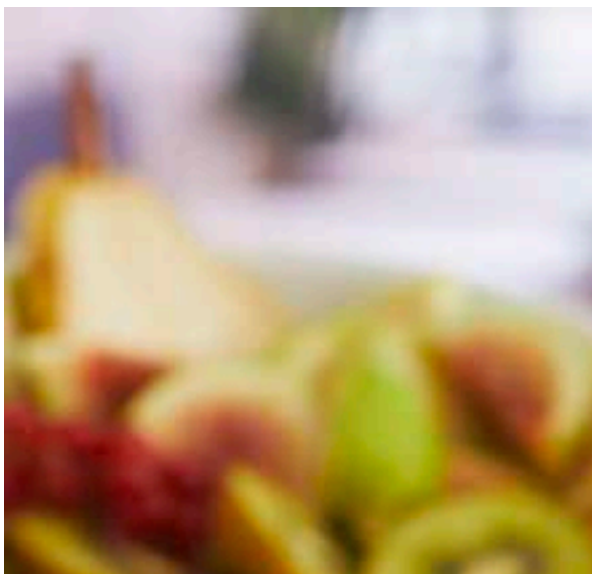

€ 7,59



T8443 | ciotola inclinata | *sloping bowl*
cm 17,8x6,6x11,5 | pz. conf. 1 | c/c 18



€ 13,68



T8444 | ciotola inclinata | *sloping bowl*
cm 20,3x7,5x13 | pz. conf. 1 | c/c 12



€ 29,81



T8445 | ciotola inclinata | *sloping bowl*
cm 27,4x18x10 | pz. conf. 1 | c/c 6





€ 13,05



T8450 | vassoio venezia | tray venezia
GN 1/3 | h 3cm | pz. conf. 1 | c/c 18



€ 16,97



T8451 | vassoio venezia | tray venezia
GN 1/3 | h 6cm | pz. conf. 1 | c/c 10



€ 18,00



T8452 | vassoio venezia | tray venezia
GN 1/2 | h 3cm | pz. conf. 1 | c/c 12



€ 23,40



T8453 | vassoio venezia | tray venezia
GN 1/2 | h 6cm | pz. conf. 1 | c/c 8



€ 21,60



T8454 | vassoio venezia | tray venezia
GN 2/4 | h 3cm | pz. conf. 1 | c/c 12



€ 28,08



T8455 | vassoio venezia | tray venezia
GN 2/4 | h 6cm | pz. conf. 1 | c/c 8



€ 36,14



T8456 | vassoio venezia | tray venezia
GN 1/1 | h 3cm | pz. conf. 1 | c/c 6



€ 46,98



T8457 | vassoio venezia | tray venezia
GN 1/1 | h 6cm | pz. conf. 1 | c/c 4



impilabili | stackable

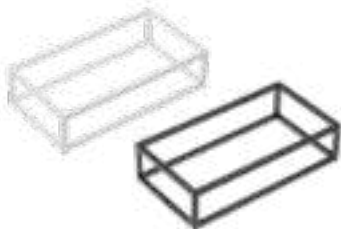

T0580.Y

stand buffet in metallo | metal buffet stand
GN 1/3 h8 cm | pz. conf. 1 | c/c 4

T0580.Z

€ 27,32

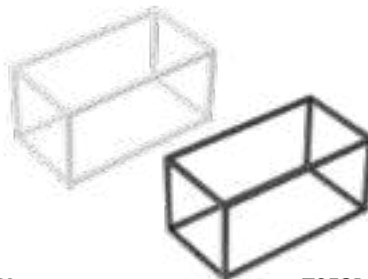

T0581.Y

stand buffet in metallo | metal buffet stand
GN 1/3 h16 cm | pz. conf. 1 | c/c 4

T0581.Z

€ 27,72

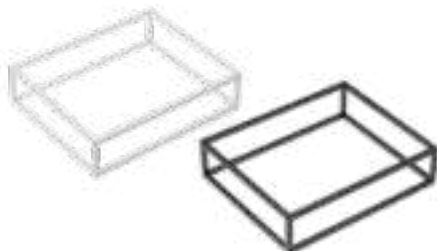

T0582.Y

stand buffet in metallo | metal buffet stand
GN 1/2 h8 cm | pz. conf. 1 | c/c 4

T0582.Z

€ 29,48

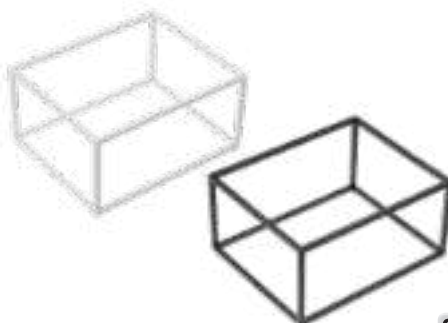

T0583.Y

stand buffet in metallo | metal buffet stand
GN 1/2 h16 cm | pz. conf. 1 | c/c 4

T0583.Z

€ 31,50

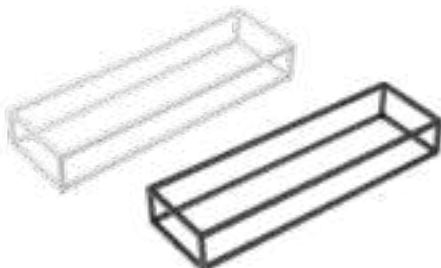

T0584.Y

stand buffet in metallo | metal buffet stand
GN 2/4 h8 cm | pz. conf. 1 | c/c 4

T0584.Z

€ 29,66

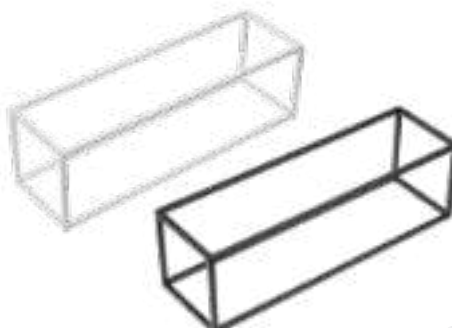

T0585.Y

stand buffet in metallo | metal buffet stand
GN 2/4 h16 cm | pz. conf. 1 | c/c 4

T0585.Z

€ 30,20

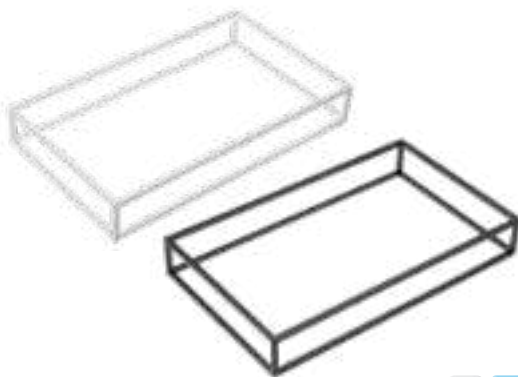

T0586.Y

stand buffet in metallo | metal buffet stand
GN 1/1 h8 cm | pz. conf. 1 | c/c 4

T0586.Z

€ 35,69

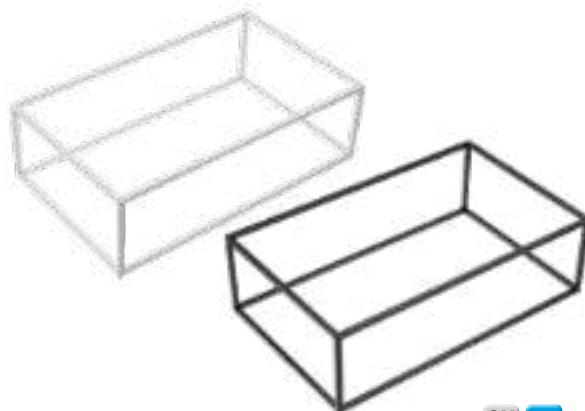

T0587.Y

stand buffet in metallo | metal buffet stand
GN 1/1 h16 cm | pz. conf. 1 | c/c 2

T0587.Z

€ 39,96







€ 4,20



T8433 | vassoio rettangolare | *rectangular tray* | cm 26x16x1,5 | pz. conf. 1 | c/c 12



€ 10,07



T8430 | vassoio rettangolare | *rectangular tray* | cm 32x17x1,5 | pz. conf. 1 | c/c 18



€ 14,82



T8431 | vassoio rettangolare | *rectangular tray* | cm 26x32x1,5 | pz. conf. 1 | c/c 12



€ 25,21



T8432 | vassoio rettangolare | *rectangular tray* | cm 53x32x1,5 | pz. conf. 1 | c/c 6



€ 14,46



T8434 | vassoio rettangolare | *rectangular tray* | cm 53x16x1,5 | pz. conf. 1 | c/c 6



avenue



€ 11,14



T8425 | vassoio quadrato | square tray |
cm 30x30x1,5 | pz. conf. 1 | c/c 16



€ 15,14



T8424 | vassoio quadrato | square tray |
cm 40x40x1,5 | pz. conf. 1 | c/c 12



€ 11,14



T8421 | vassoio rettangolare | rectangular
tray | cm 32x26x1,5 | pz. conf. 1 | c/c 16



€ 22,28



T8420 | vassoio rettangolare | rectangular
tray | cm 53x32x1,5 | pz. conf. 1 | c/c 8



€ 7,46



T8423 | vassoio quadrato | square tray |
cm 20x20x1,5 | pz. conf. 1 | c/c 24



€ 7,46



T8422 | vassoio rettangolare | rectangular
tray | cm 26x16x1,5 | pz. conf. 1 | c/c 24



€ 27,90



T8437 | vassoio rettangolare | rectangular
tray | cm 65x45x1,5 | pz. conf. 1 | c/c 4



SNOW



€ 11,74



T8417.Z | vassoio quadrato | *square tray*
cm 30x30x2,5 | pz. conf. 1 | c/c 12



€ 11,74



T8417 | vassoio quadrato | *square tray*
cm 30x30x2,5 | pz. conf. 1 | c/c 12



€ 35,90



T8415.Z | vassoio rettangolare | *rectangular tray*
cm 65x45x2,5 | pz. conf. 1 | c/c 4



€ 55,26



T8415 | vassoio rettangolare | *rectangular tray*
cm 65x45x2,5 | pz. conf. 1 | c/c 4



€ 16,17



T8016.Z | 800g
vassoio rettangolare | *rectangular tray*
cm 48x30x2,5 | pz. conf. 1 | c/c 12



€ 38,88



T8416.Z | 2100g
vassoio rettangolare | *rectangular tray*
cm 53x32x2,5 | pz. conf. 1 | c/c 6



€ 16,17



T8016 | 800g
vassoio rettangolare | *rectangular tray*
cm 48x30x2,5 | pz. conf. 1 | c/c 12



€ 5,13



T8418 | vassoio quadrato | *square tray*
cm 20x20x2,4 | pz. conf. 1 | c/c 48



€ 38,88



T8416 | 2100g
vassoio rettangolare | *rectangular tray*
cm 53x32x2,5 | pz. conf. 1 | c/c 6



€ 4,79



T8204 | vassoio 3 scomparti | 3 compartments tray | cm 27x9x3,5 | pz. conf. 1 | c/c 24



€ 8,02



T8209 | piatto piano | flat dish | cm Ø 28x3 | pz. conf. 1 | c/c 24



€ 3,63



T8227 | piatto ovale | oval dish | cm 25x13,6x4,3 | pz. conf. 1 | c/c 24



€ 12,92



T8210 | vassoio rettangolare | rectangular tray | cm 30x21x3 | pz. conf. 1 | c/c 12



€ 6,68



T8226 | vassoio rettangolare | rectangular tray | cm 24x13,8x2,1 | pz. conf. 1 | c/c 24





€ 2,34



T8207 | coppetta nera | *black cup*
cm 13x11x3,5 | pz. conf. 1 | c/c 48



€ 2,23



T8221 | ciotola stone | *stone bowl*
cm 14x8x2,5 | pz. conf. 1 | c/c 48



€ 4,12



T8201 | coppetta nera | *black small cup*
cm 18x15x5,5 | pz. conf. 1 | c/c 48



€ 5,85



T8220 | ciotola stone | *stone bowl*
cm 22x14,7x4,7 | pz. conf. 1 | c/c 24



€ 6,85



T8214 | piatto stone | *stone tray*
cm 34x10,5x3 | pz. conf. 1 | c/c 24



€ 4,46



T8213 | piatto stone | *stone tray*
cm 20x8,5x3 | pz. conf. 1 | c/c 36



€ 2,46



T8206 | coppetta ovale | *oval cup*
cm 18x10x3,5 | pz. conf. 1 | c/c 24



€ 4,51



T8258 | foglia nera | *black leaf shaped tray*
cm 41x9,5x3 | pz. conf. 1 | c/c 24



€ 7,02



T8205 | piatto ovale | *oval plate*
cm 31x16x4 | pz. conf. 1 | c/c 24



€ 7,13



T8224 | vassoio foglia nera | *black leaf tray*
cm 36,5x15,5x2,7 | pz. conf. 1 | c/c 36



€ 8,42



T8228 | ciotola nera | *black bowl*
cm Ø19x9 | pz. conf. 1 | c/c 24





€ 9,53



T8269 | ciotola inclinata | *sloping bowl*
cm Ø17,5x12,2 | pz. conf. 1 | c/c 12



€ 5,37



T8263 | ciotola tonda | *round bowl*
cm Ø15,4x5,3 | pz. conf. 1 | c/c 24



€ 3,99



T8262 | ciotola tonda | *round bowl*
cm Ø12,7x4,5 | pz. conf. 1 | c/c 36



€ 2,26



T8261 | ciotola tonda | *round bowl*
cm Ø10x3,5 | pz. conf. 1 | c/c 48



€ 1,35



T8260 | ciotola tonda | *round bowl*
cm Ø7,6x2,7 | pz. conf. 1 | c/c 72



€ 1,15



T8181.Z | coppetta nera | *black bowl*
cm Ø9x2,4 | pz. conf. 1 | c/c 84



lanzarote



€ 5,57



T8265 | vassoio rettangolare | *rectangular tray* | cm 29x13,5x2 | pz. conf. 1 | c/c 18



€ 7,29



T8264 | vassoio rettangolare | *rectangular tray* | cm 32,6x15x2 | pz. conf. 1 | c/c 18



€ 3,88



T8271 | vassoio quadrato | *black square tray* | cm 15x15x2 | pz. conf. 1 | c/c 36



€ 6,03



T8273 | vassoio quadrato | *black square tray* | cm 21x21x2 | pz. conf. 1 | c/c 18



€ 4,88



T8268 | vassoio ovale | *oval tray* | cm 26,2x12,8x1,8 | pz. conf. 1 | c/c 24



€ 5,30



T8272 | vassoio quadrato | *black square tray* | cm 18x18x2 | pz. conf. 1 | c/c 24



€ 14,68



T8266 | vassoio rettangolare | *rectangular tray* | cm 60x20x2,5 | pz. conf. 1 | c/c 12



€ 12,35



T8267 | vassoio rettangolare | *rectangular tray* | cm 53x16,2x2,5 | pz. conf. 1 | c/c 6



€ 5,46



T8257 | mini wok | *mini wok*
cm Ø 20x 2,5 | pz. conf. 1 | c/c 24



€ 5,55



T8216 | padellino | *small pan*
cm Ø 15,5x3,5 | pz. conf. 1 | c/c 36



€ 4,90



T8223 | pentolino | *small pan*
cm Ø 15x5,7 | pz. conf. 1 | c/c 36



€ 8,19



T8219 | padellino | *small pan*
cm Ø 19,5x3,7 | pz. conf. 1 | c/c 24



€ 5,89



T8523.Z | casseruola nera | *black mini pan*
cm 10,2x6,8 | pz. conf. 1 | c/c 32



€ 11,41



T8256 | padellino nero | *black small pan*
cm Ø 24x 4 | pz. conf. 1 | c/c 24





€ 3,23  

T8215 | coppetta rettangolare | *rectangular cup*
cm 10,6x9,6x5 | pz. conf. 1 | c/c 48



€ 1,95  

T8202 | piattino nero | *black small plate*
cm 9x7x3 | pz. conf. 1 | c/c 48



€ 2,62  

T8203 | coppetta quadrata | *square cup*
cm 7x7x6 | pz. conf. 1 | c/c 48



€ 2,67  

T8270 | ciotolina nera | *black small bowl*
cm Ø7,8x5,8 | pz. conf. 1 | c/c 48



€ 3,11  

T8208 | coppetta tonda | *round cup*
cm Ø 12x5,3 | pz. conf. 1 | c/c 48



€ 2,90  

T8222 | ciotola tonda | *round cup*
cm Ø 11,4x5,8 | pz. conf. 1 | c/c 48





€ 15,27



T8253 | vassoio tondo | *round tray*
cm Ø 39,7x3,4 | pz. conf. 1 | c/c 12



€ 11,23



T8251 | vassoio tondo | *round tray*
cm Ø 34,6x3,3 | pz. conf. 1 | c/c 16



€ 16,23



T8250 | piatto tondo | *round plate*
cm Ø 31,2x8,5 | pz. conf. 1 | c/c 12



€ 32,21



T8255 | vassoio quadrato | *square tray*
cm 40x40x3,8 | pz. conf. 1 | c/c 6



€ 25,87



T8254 | vassoio rettangolare | *rectangular tray*
cm 40,5x26x3,8 | pz. conf. 1 | c/c 8



sushi



€ 12,24



T8275 | vassoio sushi nero | *black sushi tray*
cm 27x18x2,3 | pz. conf. 1 | c/c 12



€ 6,40



T8274 | vassoio sushi nero | *black sushi tray*
cm 20,8x12x2,3 | pz. conf. 1 | c/c 24



€ 15,56



T8276 | vassoio sushi nero | *black sushi tray*
cm 33x19x2,4 | pz. conf. 1 | c/c 8



T8116.Z | bacchette nere | *black chopsticks*
cm 27 | pz. conf. 10 paia | c/c 20 € 10,71
T8117 | supporto per bacchette | *chopsticks*
holder | cm 5 | pz. conf. 10 | c/c 24 € 12,65



€ 16,71



T8241 | vassoio quadrato | *square tray* | cm 30x30 | pz. conf. 1 | c/c 10



€ 17,82



T8242 | vassoio rettangolare | *rectangular tray* | cm 38x26 | pz. conf. 1 | c/c 10



€ 8,91



T8243 | vassoio rettangolare | *rectangular tray* | cm 26x16 | pz. conf. 1 | c/c 20



€ 16,71



T8240 | vassoio tondo | *round tray* | cm Ø 30 | pz. conf. 1 | c/c 10



€ 15,60



T8225 | vassoio rettangolare | *rectangular tray* | cm 40x15x1,8 | pz. conf. 1 | c/c 12



€ 36,21



T8212 | vassoio rettangolare | *rectangular tray* | cm 50x25x2 | pz. conf. 1 | c/c 6



€ 16,55



T8211 | vassoio quadrato | *square tray* | cm 25x25x2 | pz. conf. 1 | c/c 12



€ 10,52



T8323 | vassoio rettangolare | *rectangular tray* | cm 16x26x1,5 | pz. conf. 1 | c/c 12



€ 12,15



T8320 | vassoio rettangolare | *rectangular tray* | cm 32x17x1,5 | pz. conf. 1 | c/c 18



€ 17,71



T8321 | vassoio rettangolare | *rectangular tray* | cm 32x26x1,5 | pz. conf. 1 | c/c 12



€ 21,06



T8324 | vassoio rettangolare | *rectangular tray* | cm 16x53x1,5 | pz. conf. 1 | c/c 6



€ 35,54



T8322 | vassoio rettangolare | *rectangular tray* | cm 53x32x1,5 | pz. conf. 1 | c/c 6

gastronom



GN1/1

GN2/4

GN2/4

GN1/2

GN1/4

GN1/4

GN1/3

GN1/3

GN1/3



€ 1,51



T8552 | ciotolina quadrata | *square bowl*
cm 6,5x6,5x2,8 | pz. conf. 1 | c/c 72



€ 2,37



T8553 | bis ciotoline quadrate | *square bowl set*
cm 11,5x6,5x2,8 | pz. conf. 1 | c/c 48



€ 3,32



T8554 | tris ciotoline quadrate | *square bowl set*
cm 17,5x6,5x2,8 | pz. conf. 1 | c/c 36



€ 4,52



T8555 | vassoio rettangolare | *rectangular tray*
cm 19x12,3x2 | pz. conf. 1 | c/c 36



€ 6,11



T8556 | vassoio rettangolare | *rectangular tray*
cm 25x12,2x2 | pz. conf. 1 | c/c 24





€ 1,74

T8550 | ciotolina | *small bowl*
cm Ø7,6x2,7 | pz. conf. 1 | c/c 72



€ 3,01

T8557 | ciotola | *bowl*
cm Ø11,5x5,5 | pz. conf. 1 | c/c 36



€ 4,33

T8551 | ciotola | *bowl*
cm Ø12,7x4,5 | pz. conf. 1 | c/c 36



€ 6,67

T8558 | ciotola | *bowl*
cm Ø16,7x7,7 | pz. conf. 1 | c/c 24





€ 11,23



T8346 | tagliere effetto legno | wood effect tray | cm 37x14x1,5 | pz. conf. 1 | c/c 12



€ 20,57



T8344 | tagliere effetto legno | wood effect tray | cm Ø32x1,5 | pz. conf. 1 | c/c 12

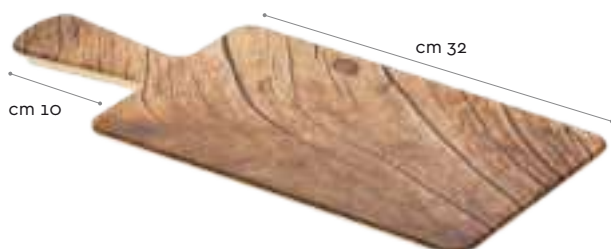

€ 15,35



T8347 | tagliere effetto legno | wood effect tray | cm 42x18x1,5 | pz. conf. 1 | c/c 12



€ 26,06



T8345 | tagliere effetto legno | wood effect tray | cm Ø36x1,5 | pz. conf. 1 | c/c 12







venus

€ 206,88



P5001 | scaldavivande tondo | *roll top chafing dish* | cm 47x47x45 | pz. conf. 1 | c/c 1



jupiter

€ 259,92



P5000 | scaldavivande | *chafing dish* cm 63,5x45,5x44 | pz. conf. 1 | c/c 1



- Voltaggio/ *Voltage* 220/240V
- Temp. Max 90°
- Potenza/ *Power* 400W
- Adatta a tutti i modelli/ *Suitable for any model*
- Garanzia 1 anno/ *Warranty 1 year*
- Conforme norme CE/ *Complies with CE regulation*

€ 33,42



P5007 | piastra elettrica | *electric heating* 400 w | pz. conf. 1 | c/c 4

- Acciaio Inox lucido/ *shining stainless steel*
- Modello rettangolare fornito di 2 bruciatori removibili, 1 bruciatore per il modello rotondo / *rectangular shape equipped with 2 removable cans, one can for round shape.*
- Maniglia ergonomica/ *Ergonomic handle*
- Dotato di viti per l'utilizzo anche con piastra elettrica/ *Equipped with screws to be used with electric panel*
- Blocco parziale e totale/ *Partial or total lock* (P5000 - P5001)
- Bacinella gastronorm in acciaio inox 18/10 / *Gastronorm pan 1/1 ss 18/10* (P5004)



mercury

€ 97,60



P5003 | scaldavivande | *chafing dish* cm 58, 5x35x32 | pz. conf. 1 | c/c 1



mars

€ 196,27



P5002 | scaldavivande | *chafing dish* cm 61x36x43 | pz. conf. 1 | c/c 1



€ 32,89



P5006 | bacinella tonda | *round food pan*
cm Ø 39x7 | pz. conf. 1 | c/c 3



€ 30,77



P5004 | bacinella rettang. | *rect. food pan*
cm 53x32,5x6,5 | pz. conf. 1 | c/c 3





€ 42,33

GI SS

P5102 | dispenser cereali | cereal dispenser
lt. 1,8 | pz. conf. 1 | c/c 4



€ 58,25

GI SS

P5103 | dispenser succhi | juice dispenser
lt. 3 | pz. conf. 1 | c/c 4



€ 6,80

GI MF

T3017 | vasetto con cucchiaino | bowl with
spoon | cm Ø 8x6 | pz. conf. 1 | c/c 18



€ 29,34

GI MF

S5031 | set 3 marmellatiere | 3 jam holder set
cm 29,5x12,5x5 | pz. conf. 1 | c/c 5



74 ACACIA BUFFET & TAGLIERI



€ 37,01 **SL** **W**

S5054 | stand in acacia e ardesia | *acacia stand*
 cm 39,5x25x39,5 | pz. conf. 1 | c/c 3



€ 46,78 **GI** **W**

S5053 | set 3 portacereali | *3 cereal holder*
 set cm 40x14,5x11 | pz. conf. 1 | c/c 4



€ 13,77 **W** **MF**

S5026 | set 3 ciotole | *3 bowls set*
 cm 31,5x11,5x4 | pz. conf. 1 | c/c 10





€ 102,58



S5049 | set espositori 3 pz. | 3 pcs acacia display | cm 60/45/30x30 | pz. conf. set 3 pz. | c/c 2



€ 46,57



S5051 | set alzata buffet acacia | set acacia display | cm 45x20x40 | pz. conf. 1 | c/c 2



€ 56,02



S5052 | set alzata buffet acacia | set acacia display | cm 65x20x40 | pz. conf. 1 | c/c 2



€ 56,02



S5050 | set espositori 3 pz. | 3 pcs acacia display | cm 13/18/23 | pz. conf. set 3 pz. | c/c 2





€ 13,54



S5041 | portatovaglioli | *napkin holder*
cm 14x14x10 | pz. conf. 1 | c/c 12



€ 16,80



S5040 | portatovaglioli | *napkin holder*
cm 18,6x18,6x10 | pz. conf. 1 | c/c 12



€ 30,81



S5042 | portabicchieri | *glass holder*
cm 23x12x30 | pz. conf. 1 | c/c 6





€ 14,48



T0574 | supporto gommato | coated stand
cm 26x26x10,5 | pz. conf. 1 | c/c 6



€ 10,71



T0576.S | supporto gommato | coated stand
cm 10x10 | pz. conf. 1 | c/c 6



€ 13,89



T0576.M | supporto gommato | coated
stand cm 15x15 | pz. conf. 1 | c/c 6



€ 11,35



T0575.M | supporto gommato | coated stand
cm 16,5x16,5x20 | pz. conf. 1 | c/c 6



€ 16,76



T0576.L | supporto gommato | coated stand
cm 20x20 | pz. conf. 1 | c/c 6



€ 12,21



T0575.L | supporto gommato | coated stand
cm 20,5x20,5x20 | pz. conf. 1 | c/c 6





€ 13,77



S5055 | disco buffet in acacia | *acacia buffet disk* | cm Ø 28x2 | pz. conf. 1 | c/c 6



€ 16,80



S5056 | disco buffet in acacia | *acacia buffet disk* | cm Ø 33x2 | pz. conf. 1 | c/c 6



€ 22,64



S5057 | disco buffet in acacia | *acacia rectangular tray* | cm Ø 38x2 | pz. conf. 1 | c/c 6



€ 6,70



T0577 | supporto cromato | *chromed stand* | cm 28x20x20,5 | pz. conf. 1 | c/c 12



€ 10,65



S5021 | cassetina | wooden box
cm 16x11x11 | pz. conf. 1 | c/c 10



€ 18,21



S5043 | portabustine/posate | sachet/
cutlery holder | cm 16,5x27,5x6 | pz. conf. 1 |
c/c 8



€ 22,41



S5044 | portaposate | cutlery holder
cm 15x15x15 | pz. conf. 1 | c/c 8



€ 18,21



S5025 | portabustine | sachet holder
cm 39x10,2x7,5 | pz. conf. 1 | c/c 4



€ 22,88



S5024 | portabustine | sachet holder
cm 39x10,2x10 | pz. conf. 1 | c/c 4



€ 17,11



S5004 | cassetta rettangolare | rectang.
wood box | cm 32,5x26,5x7 | pz. conf. 1 | c/c 5



€ 24,27



S5023 | cassetina | wooden box
cm 26x15x11,7 | pz. conf. 1 | c/c 8



€ 17,97



S5022 | cassetina | wooden box
cm 23x15,5x12 | pz. conf. 1 | c/c 8



€ 14,00



S5005 | cassetina blackwood | blackwood
box | cm 33x13x7 | pz. conf. 1 | c/c 10



€ 11,56



S5003 | cassetta quadrata | square wood box
| cm 20x20x7 | pz. conf. 1 | c/c 10



€ 20,54



S5006 | cassetina blackwood | blackwood
box | cm 35x24x6 | pz. conf. 1 | c/c 5



PERFECT BUFFET

SET COMPLETO 18 pz
In legno di acacia e melamina

Modulabile e adattabile a qualsiasi buffet, questo elegante set in legno di acacia con i ripiani in melamina è ideale per ogni tipo di presentazione, dalla colazione in B&B all'evento più raffinato.

Adjustable and adaptable to any kind of buffet, this elegant set in acacia wood with melamine shelves is ideal for all types of display, either for a breakfast in a B&B or for a more elegant party.

€ 264,16



S5102 | set perfect buffet | set perfect buffet
pz. conf. 1 | c/c 1





€ 11,91



S5000 | modulo aperto | open-component |
cm 30x19,5x7,7 | pz. conf. 1 | c/c 10



€ 17,05



S5001 | modulo aperto | open-component |
cm 36x30x7,7 | pz. conf. 1 | c/c 5



€ 24,76



S5002 | modulo aperto | open-component |
cm 56,3x36x7,7 | pz. conf. 1 | c/c 5



€ 17,27



S5000.T | modulo chiuso | closed-component |
cm 30x19,5x6 | pz. conf. 1 | c/c 10



€ 20,49



S5000.R | modulo contenitore | acacia
container | cm 30x19,5x11 | pz. conf. 1 | c/c 6



€ 20,54



S5001.T | modulo chiuso | closed-component |
cm 36x30x6 | pz. conf. 1 | c/c 5



€ 26,97



S5001.R | modulo contenitore | acacia
container | cm 36x30x11,5 | pz. conf. 1 | c/c 4



€ 28,83



S5002.T | modulo chiuso | closed-component |
cm 56,3x36x6 | pz. conf. 1 | c/c 5



€ 41,95



S5002.R | modulo contenitore | acacia
container | cm 56,3x36x11 | pz. conf. 1 | c/c 4





€ 31,90



T5056 | caraffa policarbonato | *polycarb. pitcher* | lt. 2 | pz. conf. 1 | c/c 12



€ 10,40



T5052.C | coperchio per ciotola | *bowl cover* | cm Ø 23 | pz. conf. 1 | c/c 24



€ 5,24



T5002 | mattonella refrigerante | *ice box* | cm 20x17x3 - 850 ml | pz. conf. 1 | c/c 12



€ 10,40



T5052.P | ciotola in policarbonato | *polycarbonate bowl* | cm Ø 23 | pz. conf. 1 | c/c 24



€ 1,94



T5024 | mattonella refrigerante | *freeze tile* | cm 13,5x12,5x1,4 | pz. conf. 1 | c/c 50



€ 1,61



T8138 | cucchiaino bianco | *white spoon* | cm 26,5 | pz. conf. 1 | c/c 48



€ 18,43



S5048 | supporto per caraffe | *base for pitcher* | cm 20x20x8 | pz. conf. 1 | c/c 6

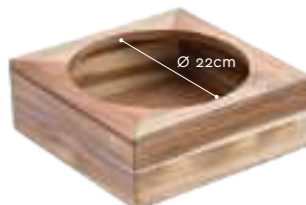

€ 28,94



S5047 | supporto per ciotole | *base for bowl* | cm 26x26x11 | pz. conf. 1 | c/c 6



€ 44,90

S5100 | set caraffa | *pitcher set* | pz. conf. 1 | c/c 1



€ 46,90

S5101 | set ciotola | *bowl set* | pz. conf. 1 | c/c 1





€ 50,95

T0550 | coperchio apribile |
openable cover
cm 53x32,5x17,5 | pz. conf. 1 | c/c 2



€ 5,20

T5106 | jelly bag caldo/freddo |
hot&cold jelly bag | cm 26x16 |
pz. conf. 1 | c/c 24



€ 39,50

T0551 | coperchio apribile |
openable cover
cm 42,5x29x15 | pz. conf. 1 | c/c 2



€ 19,40



T8061 | vassoio ambra | ambra tray
cm 53x32,5x2 | pz. conf. 1 | c/c 6



€ 14,16



T8063 | vassoio ambra | ambra tray
cm 41,5x28x2 | pz. conf. 1 | c/c 6



€ 34,00



T8060 | vassoio ambra | ambra tray
cm 53x32,5x6 | pz. conf. 1 | c/c 6



€ 22,55



T8062 | vassoio ambra | ambra tray
cm 41,5x28x6 | pz. conf. 1 | c/c 6



€ 43,63



S5045 | supporto per vassoio | stand for tray
cm 53,2x32,5x9 | pz. conf. 1 | c/c 4



€ 35,01



S5046 | supporto per vassoio | stand for tray
cm 42x28x9 | pz. conf. 1 | c/c 4



€ 111,90

S5103 | set espositore | acacia buffet set
cm 53,2x32,5x27 | pz. conf. 1 | c/c 1



€ 89,90

S5104 | set espositore | acacia buffet set
cm 42x28x27 | pz. conf. 1 | c/c 1





cm 43x35,5x33

cm 39x36x20,5

cm 35,5x35x9



€ 126,50





S5068 | stand buffet in acacia 3 scomparti |
acacia buffet stand 3 compartments
pz. conf. 1 | c/c 2



90 ACACIA BUFFET & TAGLIERI





€ 11,93  

S5066 | tagliere in acacia | acacia wood cutboard | cm 32,5x26,5x2 | pz. conf. 1 | c/c 8  





€ 8,82  

S5064 | tagliere in acacia | acacia wood cutboard | cm 32,5x17,5x2 | pz. conf. 1 | c/c 10  





€ 16,61  

S5067 | tagliere in acacia | acacia wood cutboard | cm 40x30x2 | pz. conf. 1 | c/c 6  



€ 10,13  

S5065 | tagliere in acacia | acacia wood cutboard | cm 32,5x21,5x2 | pz. conf. 1 | c/c 10  



€ 15,68



S5062 | ciotola in acacia | *acacia bowl*
cm Ø 21x7 | pz. conf. 1 | c/c 5



€ 9,80



S5014 | piatto tondo | *round dish*
cm Ø 20x2 | pz. conf. 1 | c/c 20



€ 20,05



S5063 | ciotola in acacia | *acacia bowl*
cm Ø 25x9 | pz. conf. 1 | c/c 5



€ 12,13



S5015 | piatto tondo | *round dish*
cm Ø 25x2 | pz. conf. 1 | c/c 10



€ 14,71



S5013 | vassoio | *wooden tray*
cm 60x12,5x3 | pz. conf. 1 | c/c 10



€ 15,82



S5016 | vassoio | *wooden tray*
cm 60x12x3 | pz. conf. 1 | c/c 10



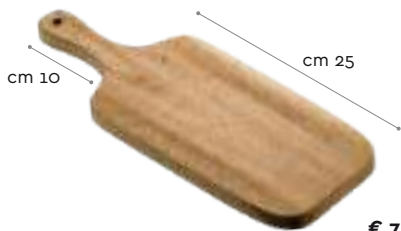

€ 7,70



S5012 | tagliere | chopping board
cm 25x13x1,5 | pz. conf. 1 | c/c 10



€ 16,34



S5018 | tagliere | chopping board
cm 35x24,5x1,8 | pz. conf. 1 | c/c 10

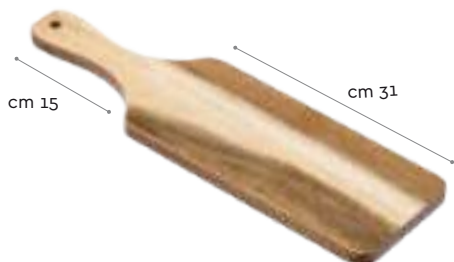

€ 9,94



S5009 | tagliere | chopping board
cm 46x13x1,6 | pz. conf. 1 | c/c 8



€ 20,54



S5017 | tagliere | chopping board
cm 41x29,5x1,8 | pz. conf. 1 | c/c 10

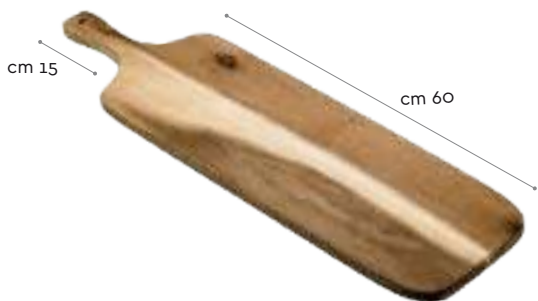

€ 18,67



S5010 | tagliere | chopping board
cm 75x20x1,6 | pz. conf. 1 | c/c 5



€ 11,91



S5011 | tagliere | chopping board
cm 45x18x1,6 | pz. conf. 1 | c/c 5





€ 14,93



S5027 | vassoio c/ciotola | tray with bowl
cm 45x13x4,5 | pz. conf. 1 | c/c 10



€ 14,23



S5028 | vassoio c/ciotola | tray with bowl
cm 25x20x1,5 | pz. conf. 1 | c/c 10



€ 16,80



S5032 | vassoio c/ciotola | tray with bowl
cm 39,4x25x1,5 | pz. conf. 1 | c/c 10



€ 15,41



S5029 | vassoio c/ciotola | tray with bowl
cm 32x26x1,5 | pz. conf. 1 | c/c 10



€ 18,67



S5033 | vassoio c/ciotola | tray with bowl
cm 49,7x24,2x1,5 | pz. conf. 1 | c/c 10



€ 29,98



S5030 | vassoio tondo | wooden round tray
cm Ø 35x7 | pz. conf. 1 | c/c 5

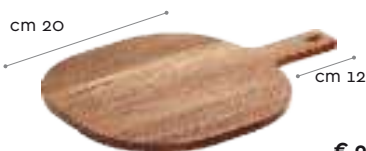

€ 9,36



55059 | tagliere squadrondo | cutting board
cm 20x20x1,5 | pz. conf. 1 | c/c 10



€ 14,92



55060 | tagliere squadrondo | cutting board
cm 30x30x1,5 | pz. conf. 1 | c/c 10



€ 26,10



55061 | tagliere squadrondo | cutting board
cm 40x40x1,5 | pz. conf. 1 | c/c 6



€ 15,41



55035 | vassoio | wooden tray
cm 20x30x5 | pz. conf. 1 | c/c 8



€ 19,14



55034 | vassoio | wooden tray
cm 38x24x5 | pz. conf. 1 | c/c 6

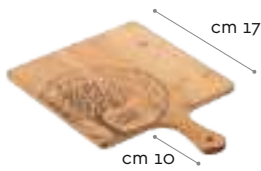

€ 4,73



S4108 | tagliere quadrato | square cutting board | cm 17x17x1 | pz. conf. 1 | c/c 40



€ 5,74



S4100 | tagliere tondo | round cutting board cm Ø 20x1 | pz. conf. 1 | c/c 30

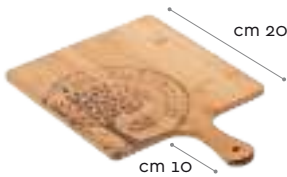

€ 5,58



S4109 | tagliere quadrato | square cutting board | cm 20x20x1 | pz. conf. 1 | c/c 30



€ 8,30



S4101 | tagliere tondo | round cutting board cm Ø 25x1 | pz. conf. 1 | c/c 25

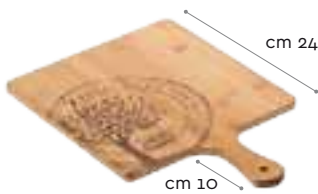

€ 8,93



S4110 | tagliere quadrato | square cutting board | cm 24x24x1 | pz. conf. 1 | c/c 25



€ 9,26



S4102 | tagliere tondo | round cutting board cm Ø 30x1 | pz. conf. 1 | c/c 20

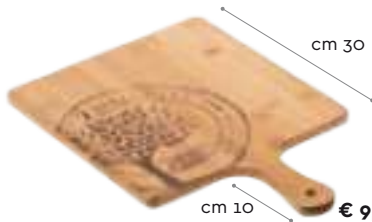

€ 9,94



S4111 | tagliere quadrato | square cutting board | cm 30x30x1 | pz. conf. 1 | c/c 20



€ 11,74



S4103 | tagliere tondo | round cutting board cm Ø 35x1 | pz. conf. 1 | c/c 15



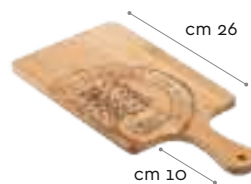

€ 5,27



S4104 | tagliere rettangolare | *rectang. cutting board* | cm 12x26x1 | pz. conf. 1 | c/c 40

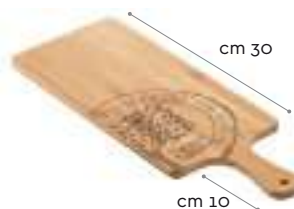

€ 5,86



S4105 | tagliere rettangolare | *rectang. cutting board* | cm 15x30x1 | pz. conf. 1 | c/c 40

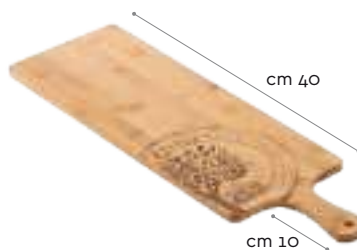

€ 7,07



S4106 | tagliere rettangolare | *rectang. cutting board* | cm 16x40x1 | pz. conf. 1 | c/c 25

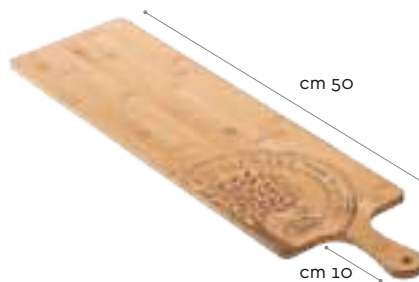

€ 8,42



S4107 | tagliere rettangolare | *rectang. cutting board* | cm 17x50x1 | pz. conf. 1 | c/c 20

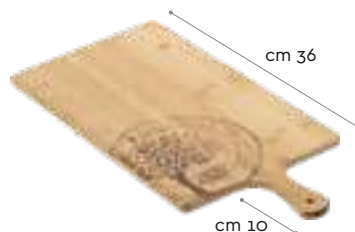

€ 7,85



S4115 | tagliere pinsa | *"pinsa" cutting board* | cm 23x36x1 | pz. conf. 1 | c/c 20



€ 7,88

S0081 | tagliere bicolor | *bicolor cutting board* | cm 22x30x1,9 | pz. conf. 1 | c/c 12



€ 13,09

S0082 | tagliere bicolor | *bicolor cutting board* | cm 40x30x1,9 | pz. conf. 1 | c/c 6

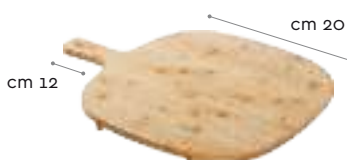

€ 7,41

S0111 | tagliere squadrondo | *cutting board* | cm 20x20x1,5 | pz. conf. 1 | c/c 24



€ 15,26

S0112 | tagliere squadrondo | *cutting board* | cm 30x30x1,5 (manico 12) | pz. conf. 1 | c/c 12

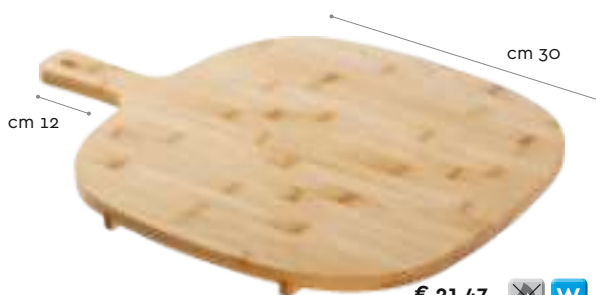

€ 21,47

S0113 | tagliere squadrondo | *cutting board* | cm 40x40x1,5 (manico 12) | pz. conf. 1 | c/c 6





€ 6,30



S0121 | tagliere Japan | *Japan cutting board*
cm 30x22x1 | pz. conf. 1 | c/c 12



€ 7,21



S0122 | tagliere Japan | *Japan cutting board*
cm 35x25x1 | pz. conf. 1 | c/c 6



€ 14,54



S0073 | tagliere rotondo | *round cutting board*
cm Ø 29x2,5 | pz. conf. 1 | c/c 12



€ 17,41



S0072 | tagliere rotondo | *round cutting board*
cm Ø 35x2,5 | pz. conf. 1 | c/c 12



€ 20,00



S0091 | piatto girevole | *turnable cutting board*
cm Ø 32 | pz. conf. 1 | c/c 12



€ 28,49



S0092 | tagliere girevole | *turnable cutting board*
cm Ø 40 | pz. conf. 1 | c/c 6





€ 7,44



S4011 | vassoio tondo | round tray
cm Ø 18,7x1,5 | pz. conf. 1 | c/c 18



€ 11,91



S4013 | vassoio tondo | round tray
cm Ø 28x1,5 | pz. conf. 1 | c/c 12



€ 9,88



S4012 | vassoio tondo | round tray
cm Ø 24x1,5 | pz. conf. 1 | c/c 18



€ 16,73



S4014 | vassoio tondo | round tray
cm Ø 33x1,5 | pz. conf. 1 | c/c 12



€ 6,92



S4007 | vassoio rettangolare | rectang. tray
cm 12x24x1,5 | pz. conf. 1 | c/c 24



€ 10,71



S4009 | vassoio rettangolare | rectang. tray
cm 30x22x1,5 | pz. conf. 1 | c/c 18



€ 7,86



S4008 | vassoio rettangolare | rectang. tray
cm 24x16x1,5 | pz. conf. 1 | c/c 18



€ 15,31



S4010 | vassoio rettangolare | rectang. tray
cm 39x29x1,5 | pz. conf. 1 | c/c 12

100 BAMBOO BUFFET & TAGLIERI

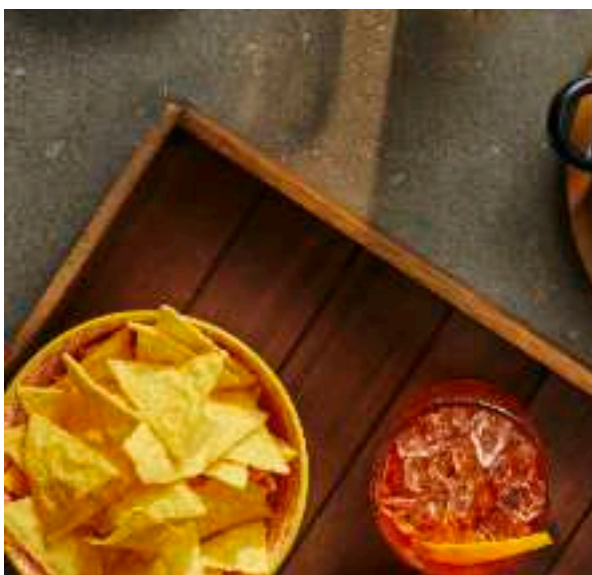

€ 5,57



S0123 | vassoio ovale | oval tray
cm 22x14x2 | pz. conf. 1 | c/c 24



€ 9,65



S0124 | vassoio ovale | oval tray
cm 28,5x21,5x2 | pz. conf. 1 | c/c 12



€ 14,80



S0125 | vassoio ovale | oval tray
cm 32x24x2 | pz. conf. 1 | c/c 6





€ 23,47



S0102 | tagliere c/antibriciole | *anti-crubs tray* | cm 40x24x4 | pz. conf. 1 | c/c 12



€ 23,47



S0103 | griglia per tagliere | *chopping board* | cm 53x32,5x1,6 | pz. conf. 1 | c/c 8



€ 22,76



S0126 | tagliere India | *India cutting board* | cm 40x30x3 | pz. conf. 1 | c/c 6



€ 43,49



S0100 | base Asia | *base Asia* | cm 53x32,5x9 | pz. conf. 1 | c/c 2



€ 25,33



S0074 | tagliere maxi | *maxi tray* | cm Ø 42x2,5 | pz. conf. 1 | c/c 6



€ 14,86



S0094 | tagliere ovale | *oval dish* | cm 21x40x1,5 | pz. conf. 1 | c/c 12





€ 2,23



T8109 | coppetta bianca | *white small cup*
cm Ø 11x5,6 | pz. conf. 1 | c/c 48



€ 1,15



T8181.Z | coppetta nera | *black bowl*
cm Ø 9x2,4 | pz. conf. 1 | c/c 84



€ 12,15



T8320 | vassoio rettangolare | *rectangular tray*
cm 32x17x1,5 | pz. conf. 1 | c/c 18



€ 30,80

S1005 | set hamburger | *hamburger set*
cm 43x20x2,4 | pz. conf. 1 | c/c 8



€ 17,25



S4005 | vassoio rettangolare | *rectangular tray*
cm 43x20x2,4 | pz. conf. 1 | c/c 8





€ 3,87



S0061 | vassoio sushi | *sushi tray*
cm 15x15x2,5 | pz. conf. 1 | c/c 36



€ 4,12



S0061.Z | vassoio sushi | *sushi tray*
cm 15x15x2,5 | pz. conf. 1 | c/c 36



€ 5,37



S0062 | vassoio sushi | *sushi tray*
cm 30x11x2,5 | pz. conf. 1 | c/c 36



€ 5,62



S0062.Z | vassoio sushi | *sushi tray*
cm 30x11x2,5 | pz. conf. 1 | c/c 36



€ 5,32



S0118 | set tagliere con ciotola | *tray with bowl*
cm 35x8,5x2,5 | pz. conf. 1 | c/c 12



€ 6,79



S0119 | set tagliere con ciotola | *tray with bowl*
cm 50x8,5x2,5 | pz. conf. 1 | c/c 12



€ 18,11



S0090.Z | vassoio sushi | *sushi tray*
cm 70x20x2,5 | pz. conf. 1 | c/c 12



€ 13,11



S0063.Z | vassoio sushi | *sushi tray*
cm 50x23x2,5 | pz. conf. 1 | c/c 12



€ 17,73



S0090 | vassoio sushi | *sushi tray*
cm 70x20x2,5 | pz. conf. 1 | c/c 12



€ 12,85



S0063 | vassoio sushi | *sushi tray*
cm 50x23x2,5 | pz. conf. 1 | c/c 12





€ 16,13



S4000 | piatto c/portabicchiere | *plate with cup holder* | cm 18x15x0,8 | pz. conf. 6 | c/c 8

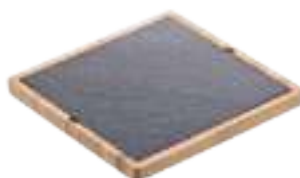

€ 8,06



S4015 | vassoio quadrato | *square tray* | cm 22x22x1,7 | pz. conf. 1 | c/c 12



€ 14,97



S4114 | vassoio Wave | *Wave tray* | cm 40x26x2,7 | pz. conf. 1 | c/c 8



€ 8,49



S4017 | vassoio rettangolare | *rectang. tray* | cm 34x14x1,7 | pz. conf. 1 | c/c 12



€ 12,01



S0083 | tagliere | *cutting board* | cm 45x28x1,6 | pz. conf. 1 | c/c 12



€ 11,89



S4016 | vassoio tondo | *round tray* | cm Ø 27x1,7 | pz. conf. 1 | c/c 12







€ 5,87



S0060 | ciotola rotonda | *round bowl*
cm Ø 11x4,5 | pz. conf. 1 | c/c 36



€ 13,11



S0060.S | ciotola rotonda | *round bowl*
cm Ø 8x4,2 | pz. conf. 4 | c/c 12



€ 20,60



S0060.XL | ciotola rotonda | *round bowl*
cm Ø 20x7,5 | pz. conf. 1 | c/c 12



€ 14,15



S0060.L | ciotola rotonda | *round bowl*
cm Ø 17x6 | pz. conf. 1 | c/c 12



€ 6,90



S0108 | cassetina | *small box*
cm 15x10x7 | pz. conf. 1 | c/c 36



€ 9,87



S0096 | cassetina portapane | *breadbox*
cm 20x15x9 | pz. conf. 1 | c/c 12



€ 16,77



S0095 | cassetina portapane | *breadbox*
cm 30x20x11 | pz. conf. 1 | c/c 8





€ 5,92



S4003 | contenitore da buffet | *buffet box*
cm 15,3x15,3x5 | pz. conf. 1 | c/c 24



€ 4,88



S4002 | contenitore da buffet | *buffet box*
cm 7,7x15,3x5 | pz. conf. 1 | c/c 36



€ 7,16



S4004 | contenitore da buffet | *buffet box*
cm 15,3x22,9x5 | pz. conf. 1 | c/c 24



€ 3,82



S4001 | contenitore da buffet | *buffet box*
cm 7,7x7,7x5 | pz. conf. 1 | c/c 36



€ 8,28



S4006 | contenitore da buffet | *buffet box*
cm 15,3x30,6x5 | pz. conf. 1 | c/c 12



€ 9,23



S0104 | formaggera | *cheese bowl*
cm Ø 11x5 | pz. conf. 1 | c/c 16





per tovaglioli
for napkins
cm 25x25

€ 8,23



S0085.Z | portatovaglioli | *napkin holder*
cm 13,5x13,5x10 | pz. conf. 1 | c/c 18



€ 8,23



S0085 | portatovaglioli | *napkin holder*
cm 13,5x13,5x10 | pz. conf. 1 | c/c 18



per tovaglioli
for napkins
cm 33x33

€ 12,13



S0086.Z | portatovaglioli | *napkin holder*
cm 19x19x10 | pz. conf. 1 | c/c 18



€ 12,13



S0086 | portatovaglioli | *napkin holder*
cm 19x19x10 | pz. conf. 1 | c/c 18



€ 6,25



S0078 | portarifiuti in bamboo | *bamboo table bin*
cm 11x11x11 | pz. conf. 1 | c/c 24



€ 17,55



S0079 | portabustine | *sachet holder*
cm 7x11x5,5 | pz. conf. 6 | c/c 6





€ 24,11



S0105.Y | portabicchieri | *glass holder*
cm 21x11x30 | pz. conf. 1 | c/c 6



€ 34,40



S4112 | alzatina bianca | *white bamboo stand*
cm 31,5x34x50 | pz. conf. 1 | c/c 5



€ 24,11



S0105.Z | portabicchieri | *glass holder*
cm 21x11x30 | pz. conf. 1 | c/c 6



€ 16,08



S0127 | portaposate Yulin | *cutlery holder*
Yulin | cm 15x15x15 | pz. conf. 1 | c/c 12



€ 24,11



S0105 | portabicchieri | *glass holder*
cm 21x11x30 | pz. conf. 1 | c/c 6



€ 15,54



S0089 | portabustine/posate | *sachet/cutlery holder*
holder | cm 29x27,5x6 | pz. conf. 1 | c/c 6





€ 31,90



T5056 | caraffa policarbonato | *polycarb. pitcher* | lt. 2 | pz. conf. 1 | c/c 12



€ 10,40



T5052.C | coperchio per ciotola | *bowl cover* cm Ø 23 | pz. conf. 1 | c/c 24



€ 5,24



T5002 | mattonella refrigerante | *ice box* | cm 20x17x3 - 850 ml | pz. conf. 1 | c/c 12



€ 10,40



T5052.P | ciotola in policarbonato | *polycarbonate bowl* | cm Ø 23 | pz. conf. 1 | c/c 24



€ 1,94



T5024 | mattonella refrigerante | *freeze tile* | cm 13,5x12,5x1,4 | pz. conf. 1 | c/c 50



€ 1,61



T8138 | cucchiaino bianco | *white spoon* | cm 26,5 | pz. conf. 1 | c/c 48

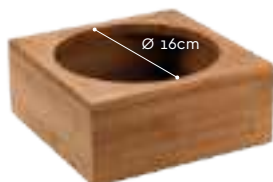

€ 16,86



S0087 | supporto per caraffa | *pitcher stand* | cm 20x20x8 | pz. conf. 1 | c/c 6



€ 26,85



S0088 | supporto per ciotole | *bowl stand* | cm 26x26x11 | pz. conf. 1 | c/c 6



€ 44,80

S1000 | set caraffa | *pitcher set* | pz. conf. 1 | c/c 1



€ 46,90

S1001 | set ciotola | *bowl set* | pz. conf. 1 | c/c 1





€ 50,95



T0550 | coperchio apribile | *openable cover*
cm 53x32,5x17,5 | pz. conf. 1 | c/c 2



€ 39,50



T0551 | coperchio apribile | *openable cover*
cm 42,5x29x15 | pz. conf. 1 | c/c 2



€ 19,40



T8061 | vassoio ambra | *ambra tray*
cm 53x32,5x2 | pz. conf. 1 | c/c 6



€ 14,16



T8063 | vassoio ambra | *ambra tray*
m 41,5x28x2 | pz. conf. 1 | c/c 6



€ 34,00



T8060 | vassoio ambra | *ambra tray*
cm 53x32,5x6 | pz. conf. 1 | c/c 6



€ 22,55



T8062 | vassoio ambra | *ambra tray*
cm 41,5x28x6 | pz. conf. 1 | c/c 6



€ 43,49



S0100 | base Asia | *base Asia*
cm 53x32,5x9 | pz. conf. 1 | c/c 2



€ 33,10



S0101 | base Asia | *base Asia*
cm 42x28x9 | pz. conf. 1 | c/c 4



€ 111,90

S1003 | set espositore | buffet set
cm 53x32,5x27 | pz. conf. 1 | c/c 1



€ 89,90

S1004 | set espositore | buffet set
cm 42x28x27 | pz. conf. 1 | c/c 1



richiudibile
foldable

€ 22,64



S0135 | alzatina in bamboo | bamboo stand
cm 34x17x33 | pz. conf. 1 | c/c 6

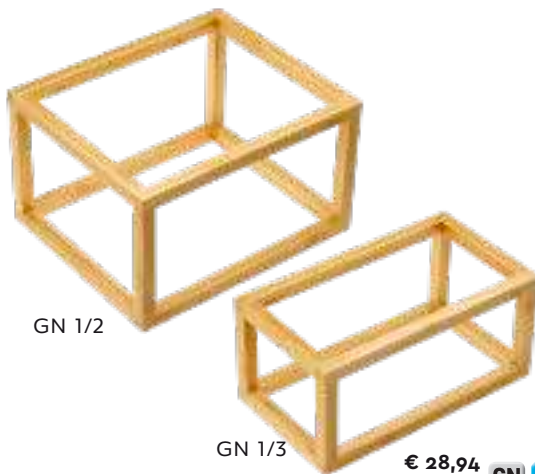

GN 1/2

GN 1/3

€ 28,94



S0136 | set supporti in bamboo | bamboo
stand set GN 1/2 GN 1/3 | pz. conf. 2 | c/c 4

116 BAMBOO BUFFET & TAGLIERI



richiudibili
foldable

€ 22,28



S0133 | stand bamboo | bamboo stand
cm 24x40x18 | pz. conf. 1 | c/c 6

€ 17,33



S0134 | stand bamboo | bamboo stand
cm 20x30x18 | pz. conf. 1 | c/c 6



€ 41,75 

S1006 | Set due caraffe + base + mattonelle refrigeranti | *Two jugs set + bamboo base + freeze tiles* | 1500ml | pz. conf. 1 | c/c 1



€ 59,25 

S1007 | Set tre caraffe + base + mattonelle refrigeranti | *Three jugs set + bamboo base + freeze tiles* | 1500ml | pz. conf. 1 | c/c 1



€ 1,94

T5024 | mattonella refrigerante freeze tile | cm 13,5x12,5x1,4 | pz. conf. 1 | c/c 50



€ 9,90

T5510 | caraffa in metacrilato | methacrylate jug | cm Ø10x27 ml 1500 | pz. conf. 1 | c/c 12



€ 8,10

T5509 | caraffa in metacrilato | methacrylate jug | cm Ø8x22,5 ml 1000 | pz. conf. 1 | c/c 12



€ 26,82 

S0132 | porta bottiglie in bamboo | *bamboo bottle holder* | cm 42x15,5x13 | pz. conf. 1 | c/c 6



€ 20,25 

S0131 | porta bottiglie in bamboo | *bamboo bottle holder* | cm 29x15,5x13 | pz. conf. 1 | c/c 6

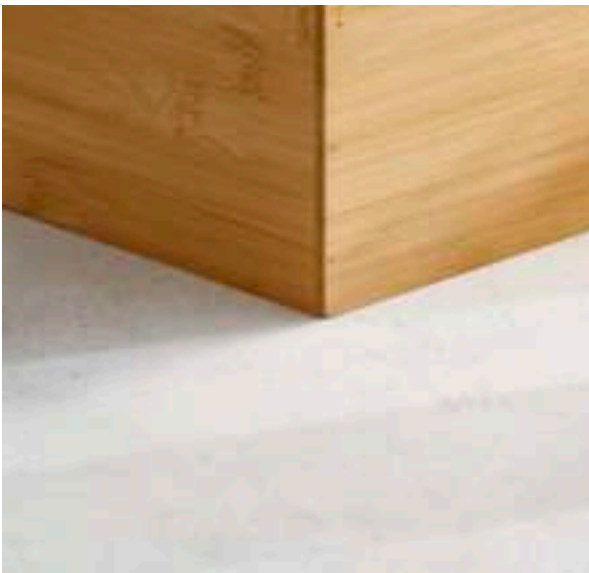



€ 58,56



S0128 | set espositori 3 pz. | 3 pcs bamboo display | cm 13/18/23 | pz. conf. 1 set | c/c 2



€ 93,00



S0130 | set espositori 3 pz. | 3 pcs bamboo display | cm 60/45/30x20 | pz. conf. 1 set | c/c 2



€ 82,96



S0128.Z | set espositori 3 pz. | 3 pcs bamboo display | cm 13/18/23 | pz. conf. 1 set | c/c 2



€ 97,76



S0097 | set espositori 3 pz. | 3 pcs bamboo display | cm 60/45/30x30 | pz. conf. 1 | c/c 2







€ 4,60



U0004.G | alzata Dali | *cakestand Dali*
cm Ø 18,5x8 | pz. conf. 1 | c/c 12

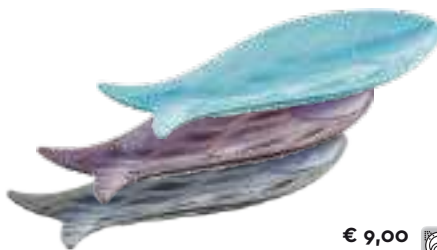

€ 9,00



U0009 | piatto pesce Mirò | *fish plate Mirò*
cm 25,5x10,5x1,8 | pz. conf. 3 | c/c 12



€ 4,20



U0005.G | alzata Gaudi | *cakestand Gaudi*
cm Ø 21,5x8,7 | pz. conf. 1 | c/c 8



€ 14,75



U0008 | tagliere Goya | *cutting board Goya*
cm 35,5x13,5x1 | pz. conf. 3 | c/c 6



€ 4,20



U0005.E | alzata Gaudi | *cakestand Gaudi*
cm Ø 21,5x8,7 | pz. conf. 1 | c/c 8



€ 14,75



U0006 | tagliere Degas | *cutting board Degas*
cm 33x17,5x1 | pz. conf. 3 | c/c 6







€ 50,95



T0550 | coperchio apribile | *openable cover*
cm 53x32,5x17,5 | pz. conf. 1 | c/c 2



€ 49,19



T0552 | coperchio rotondo | *round cover*
cm Ø 43x20 | pz. conf. 1 | c/c 5



€ 27,72



T0548.Y | cestino rettangolare | *rectang. basket*
cm 52,5x32,5x8 | pz. conf. 1 | c/c 18



€ 17,31



T0537 | cestino rotondo | *round basket*
cm Ø 40x8 | pz. conf. 1 | c/c 12



€ 27,72



T0548 | cestino rettangolare | *rectang. basket*
cm 52,5x32,5x8 | pz. conf. 1 | c/c 18



€ 23,04



T0554 | coperchio per T0549 | *cover for T0549*
cm 32,5x26x7 | pz. conf. 1 | c/c 24



€ 39,50



T0551 | coperchio apribile | *openable cover*
cm 42,5x29x15 | pz. conf. 1 | c/c 2



€ 15,39



T0549.Y | cestino rettangolare | *rectang. basket*
cm 32,5x26x6 | pz. conf. 1 | c/c 24



€ 23,98



T0547.Y | cestino rettangolare | *rectang. basket*
cm 41,5x28x8 | pz. conf. 1 | c/c 18



€ 15,39



T0549 | cestino rettangolare | *rectang. basket*
cm 32,5x26x6 | pz. conf. 1 | c/c 24



€ 23,98



T0547 | cestino rettangolare | *rectang. basket*
cm 41,5x28x8 | pz. conf. 1 | c/c 18

I supporti T0570 / T0573 sono venduti senza cestini e relativi coperchi.

Stands T0570 / T0573 are without baskets and covers.



€ 57,17



T0570 | supporto cestini T0547 | stand for T0547 | cm 47x41x35,5 | pz. conf. 1 | c/c 5



€ 63,77



T0573 | supporto cestini T0537 | stand for T0537 | cm 47x39x35,5 | pz. conf. 1 | c/c 5





€ 18,34 **PP** 

T0544 | cestino rotondo | *slanting basket*
cm Ø 36x12 | pz. conf. 1 | c/c 12



€ 8,30 **PP** 

T0534.A | cestino da pizza | *pizza basket*
cm Ø 25x3 | pz. conf. 1 | c/c 24



€ 26,62 **PP** 

T0545 | cestino rotondo | *slanting basket*
cm Ø 45x18 | pz. conf. 1 | c/c 6



€ 13,02 **PP** 

T0534 | cestino da pizza | *pizza basket*
cm Ø 35x3 | pz. conf. 1 | c/c 24



€ 13,96 **PP** 

T0527 | cestino quadrato | *square basket*
cm 30x30x6 | pz. conf. 1 | c/c 24



€ 15,72 **PP** 

T0525 | cestino rettangolare | *rectangular basket*
cm 30x40x8 | pz. conf. 1 | c/c 24





€ 22,08



T0528 | cestino inclinato | *slanting basket*
cm 45x30x5/11 | pz. conf. 1 | c/c 12



€ 23,97



T0540 | cestino inclinato | *slanting basket*
cm 34x24x11/18 | pz. conf. 1 | c/c 12



€ 74,43



T0536 | cesto inclinato | *slanting basket*
cm 51x47x13/25 | pz. conf. 1 | c/c 6



€ 61,11



T0546 | set 2 cestini con alzata | *set stand with 2 baskets*
cm 30x30x50 | pz. conf. 1 | c/c 3





€ 16,38 **PP** 

T0562 | cestino marrone | *brown basket*
cm 32,5x17,5x10 | pz. conf. 1 | c/c 30



€ 16,38 **PP** 

T0562.Z | cestino nero | *black basket*
cm 32,5x17,5x10 | pz. conf. 1 | c/c 30



€ 21,60 **PP** 

T0563 | cestino marrone | *brown basket*
cm 32,5x26,5x10 | pz. conf. 1 | c/c 30



€ 21,60 **PP** 

T0563.Z | cestino nero | *black basket*
cm 32,5x26,5x10 | pz. conf. 1 | c/c 30



€ 41,44 **PP** 

T0565 | cestino marrone | *brown basket*
cm 53x32,5x10 | pz. conf. 1 | c/c 10



€ 41,44 **PP** 

T0565.Z | cestino nero | *black basket*
cm 53x32,5x10 | pz. conf. 1 | c/c 10



€ 28,19 **PP** 

T0564 | cestino marrone | *brown basket*
cm 32,5x32,5x10 | pz. conf. 1 | c/c 10



€ 28,19 **PP** 

T0564.Z | cestino nero | *black basket*
cm 32,5x32,5x10 | pz. conf. 1 | c/c 10





€ 3,50



T0004.R | saccottino verde | *green basket*
cm 9x9x16 | pz. conf. 1 | c/c 24



€ 7,64



T0005.Z | saccottino nero | *black basket*
cm 12x12x16 | pz. conf. 1 | c/c 24



€ 6,37



T0004.Z | saccottino nero | *black basket*
cm 9x9x16 | pz. conf. 1 | c/c 24



€ 6,31



T0003.R | saccottino verde | *green basket*
cm 14x14x10 | pz. conf. 1 | c/c 24



€ 6,31



T0003.Z | saccottino nero | *black basket*
cm 14x14x10 | pz. conf. 1 | c/c 24



€ 8,44



T0006.R | saccottino verde | *green basket*
cm 15x15x16 | pz. conf. 1 | c/c 24



€ 8,44



T0006.Z | saccottino nero | *black basket*
cm 15x15x16 | pz. conf. 1 | c/c 24

Cestino di Carta lavabile sia a mano che in lavatrice a 40°.
 Per un perfetto risvoltino: immergere in acqua fredda e lasciare ammorbidire, poi ripiegare il bordo all'altezza desiderata. Lasciare asciugare.
 Avvertenze: Non ungere, tenere lontano da fonti di calore.

*Paper Basket. Hand or machine washable at 40°.
 Instructions for a perfect turn up: Dip it in cold water. Once softened, fold the edge to the desired height. Allow to dry.
 Warnings: Do not get grease on, keep away from heat source.*





€ 8,47 **PP** 

T0561.T | cestino tortora | dove grey basket
cm Ø 18x9 | pz. conf. 1 | c/c 24



€ 8,47 **PP** 

T0561.Y | cestino bianco | white basket
cm Ø 18x9 | pz. conf. 1 | c/c 24



€ 8,47 **PP** 

T0561.R | cestino marrone | brown basket
cm Ø 18x9 | pz. conf. 1 | c/c 24



€ 8,47 **PP** 

T0561.Z | cestino nero | black basket
cm Ø 18x9 | pz. conf. 1 | c/c 24



€ 10,59 **PP** 

T0558.Z | cestino nero | black basket
cm 18x18x10 | pz. conf. 1 | c/c 24



€ 9,21 **PP** 

T0559.Z | cestino nero | black basket
cm 16x16x10 | pz. conf. 1 | c/c 24



€ 10,59 **PP** 

T0558.R | cestino marrone | brown basket
cm 18x18x10 | pz. conf. 1 | c/c 24



€ 9,21 **PP** 

T0559.R | cestino marrone | brown basket
cm 16x16x10 | pz. conf. 1 | c/c 24



€ 10,59 **PP** 

T0558.T | cestino tortora | dove grey basket
cm 18x18x10 | pz. conf. 1 | c/c 24



€ 9,21 **PP** 

T0559.T | cestino tortora | dove grey basket
cm 16x16x10 | pz. conf. 1 | c/c 24







€ 7,01



T0533.R | cestino bicolor | *bicolor basket*
cm 23x19x6,5 | pz. conf. 1 | c/c 36



€ 7,58



T0531.R | portagrissini bicolor | *bicolor breadstick basket* | cm Ø 12x15 | pz. conf. 1 | c/c 36



€ 5,28



T0530.R | cestino bicolor | *bicolor basket*
cm Ø 21x6,5 | pz. conf. 1 | c/c 36



€ 5,74



T0532.R | cestino bicolor | *bicolor basket*
cm 24x16,5x6 | pz. conf. 1 | c/c 36



€ 2,48



T0501 | cestino rotondo | *round basket*
cm Ø 20x6 | pz. conf. 1 | c/c 72



€ 2,44



T0505 | cestino ovale | *oval basket*
cm 23x15x6 | pz. conf. 1 | c/c 72





€ 5,16



T0529.Z | cestino naturale Vogue | *natural basket Vogue* | cm Ø 20x6,5 | pz. conf. 1 | c/c 36



€ 5,16



T0529.Y | cestino nero Vogue | *black basket Vogue* | cm Ø 20x6,5 | pz. conf. 1 | c/c 36



€ 5,16



T0529.P | cestino cacao Vogue | *cocoa basket Vogue* | cm Ø 20x6,5 | pz. conf. 1 | c/c 36



€ 5,16



T0529.A | cestino bianco Vogue | *white basket Vogue* | cm Ø 20x6,5 | pz. conf. 1 | c/c 36



€ 5,16



T0529.T | cestino tortora Vogue | *dove gray basket Vogue* | cm Ø 20x6,5 | pz. conf. 1 | c/c 36



€ 7,87



€ 7,87



T0520.Y | cestino bianco Vogue | *white Vogue basket* | cm 28x11x7 | pz. conf. 1 | c/c 40

T0520.Z | cestino nero Vogue | *black Vogue basket* | cm 28x11x7 | pz. conf. 1 | c/c 40





€ 3,75



S0201 | bancalino in legno | *fir mini pallet*
cm 20x12x3,5 | pz. conf. 1 | c/c 24



€ 3,75



S0201.P | bancalino bianco | *white mini pallet*
cm 20x12x3,5 | pz. conf. 1 | c/c 24



€ 7,43



S0202 | bancalino in legno | *fir mini pallet*
cm 35x20x3,5 | pz. conf. 1 | c/c 16



€ 7,43



S0202.P | bancalino bianco | *white mini pallet*
cm 35x20x3,5 | pz. conf. 1 | c/c 16



€ 7,23



S0203 | bancalino in legno | *fir mini pallet*
cm 40x15x3,5 | pz. conf. 1 | c/c 16



€ 7,23



S0203.P | bancalino bianco | *white mini pallet*
cm 40x15x3,5 | pz. conf. 1 | c/c 16



€ 8,99



S0205 | cassetta in legno | *fir wood basket*
cm 25x17x10 | pz. conf. 1 | c/c 12



€ 8,99



S0205.P | cassetta bianca | *white wooden basket*
cm 25x17x10 | pz. conf. 1 | c/c 12



€ 4,84



S0204 | cassetta in legno | *fir wood basket*
cm 17x12x9 | pz. conf. 1 | c/c 24



€ 4,84



S0204.P | cassetta bianca | *white wooden basket*
cm 17x12x9 | pz. conf. 1 | c/c 24



€ 2,20



S0206 | cassetta in legno | *fir wood basket*
cm 13,5x8,5x6,7 | pz. conf. 1 | c/c 32



€ 5,98



S0210.P | cassetta bianca | *white wooden basket*
cm 27x15x6 | pz. conf. 1 | c/c 24



€ 2,68



S0211 | antina in legno | wood tray antina
cm 12,5x20x1,8 | pz. conf. 1 | c/c 36



€ 4,12



S0212 | antina in legno | wood tray antina
cm 40x15x1,8 | pz. conf. 1 | c/c 24



€ 4,45



S0215 | antina in legno | wood tray antina
cm 33x33x1,8 | pz. conf. 1 | c/c 12





cartine journal | paper journal
45g/m²



H6212 cm 12,5x20 pz. conf. 500 c/c 12	€ 10,74
H6215 cm 15x40 pz. conf. 500 c/c 6	€ 19,86
H6220 cm 20x32,5 pz. conf. 500 c/c 6	€ 22,50
H6228 cm 28x34 pz. conf. 1000 c/c 4	€ 49,76
H6231 cm 31x31 pz. conf. 1000 c/c 4	€ 51,83
H6233 cm 33x32,5 pz. conf. 500 c/c 4	€ 32,95
H6238 cm 31x38 pz. conf. 1000 c/c 4	€ 46,53
H6240 cm 40x32,5 pz. conf. 500 c/c 4	€ 39,05

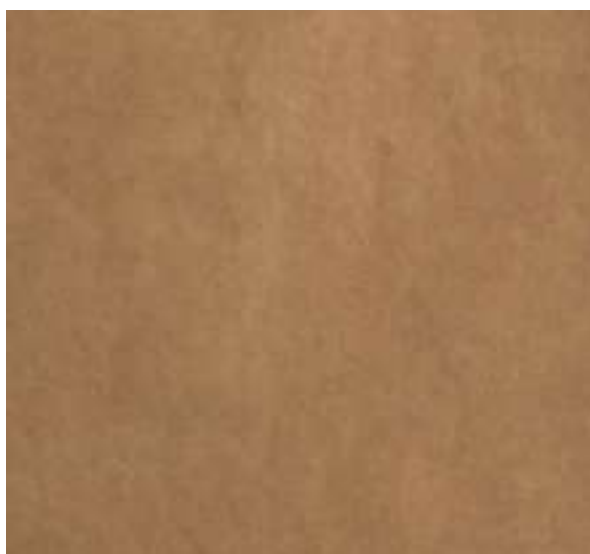

cartine avana | paper avana
40g/m²



H6112 cm 12,5x20 pz. conf. 500 c/c 12	€ 10,26
H6115 cm 15x40 pz. conf. 500 c/c 6	€ 18,15
H6120 cm 20x32,5 pz. conf. 500 c/c 6	€ 20,46
H6133 cm 33x32,5 pz. conf. 500 c/c 4	€ 31,10
H6140 cm 40x32,5 pz. conf. 500 c/c 4	€ 35,42



cartine bianca | white paper
40g/m²



H6020 cm 20x35 pz. conf. 500 c/c 6	€ 16,30
H6033 cm 33x32,5 pz. conf. 500 c/c 4	€ 24,85



cartine vintage | paper vintage
40g/m²



H6312 cm 12,5x20 pz. conf. 500 c/c 12	€ 10,74
H6315 cm 15x40 pz. conf. 500 c/c 6	€ 19,86
H6320 cm 20x32,5 pz. conf. 500 c/c 6	€ 22,50
H6333 cm 33x32,5 pz. conf. 500 c/c 4	€ 32,95
H6340 cm 40x32,5 pz. conf. 500 c/c 4	€ 39,05





€ 21,13 Pa

H6601 | cono journal | *paper cone journal*
cm 21x29,5 | pz. conf. 250 | c/c 8



€ 22,37 Pa

H6602 | cono journal | *paper cone journal*
cm 24x34 | pz. conf. 250 | c/c 4



€ 27,30 Pa

H6603 | sacchetto journal | *paper bag journal*
cm 13x14 | pz. conf. 1000 | c/c 6



€ 17,57 Pa

H6600 | cono journal | *paper cone journal*
cm 17x24 | pz. conf. 250 | c/c 8



€ 20,81 Pa

H6604 | sacchetto journal | *paper bag journal*
cm 17x18 | pz. conf. 500 | c/c 8



€ 87,14 Pa

H6606 | sacchetto vintage | *paper bag vintage* | cm 10+7,5x14 | pz. conf. 2000 | c/c 6



€ 87,14 Pa

H6605 | sacchetto vintage | *paper bag vintage* | cm 10+4x14 | pz. conf. 2000 | c/c 6



€ 58,65 Pa

H6607 | sacchetto vintage | *paper bag vintage* | cm 12+9x28 | pz. conf. 1000 | c/c 6



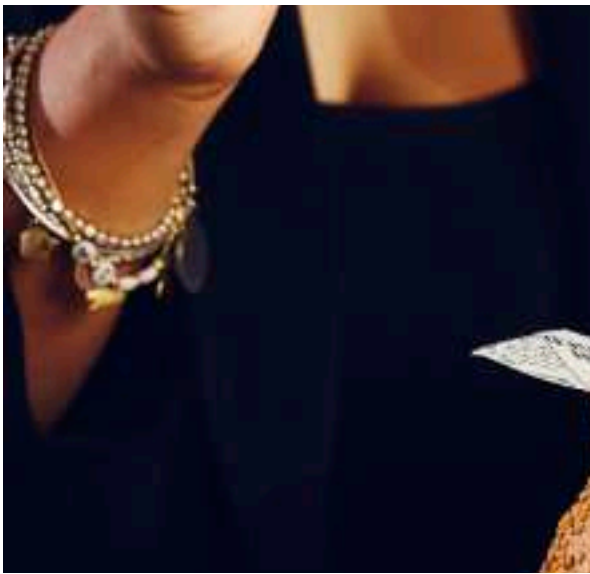



€ 8,38



T5422 | cestello quadrato | *square basket*
cm 10x10x8 | pz. conf. 1 | c/c 12



€ 9,45



T5423 | cestello tondo | *round basket*
cm Ø 9x10,5 | pz. conf. 1 | c/c 12



€ 13,69



T5424 | cestello rettangolare | *rectangular basket*
cm 21x10x6 | pz. conf. 1 | c/c 12



€ 10,08



T5420 | cestello quadrato | *square basket*
cm 12,7x12,7x10 | pz. conf. 1 | c/c 12



140 CESTELLI & PENTOLINI



€ 7,92



T5431.M | scolapasta rosso | red colander
cm Ø 18 | pz. conf. 1 | c/c 24



€ 3,50



P1001 | mini secchiello | mini bucket
cm 7x7 | pz. conf. 1 | c/c 72



€ 7,92



T5431.O | scolapasta avorio | ivory colander
cm Ø 18 | pz. conf. 1 | c/c 24



€ 8,10



P1003 | mini secchiello | mini bucket
cm 12x12 | pz. conf. 1 | c/c 48



€ 7,92



T5431.T | scolapasta tortora | dove grey
colander | cm Ø 18 | pz. conf. 1 | c/c 24



€ 4,14



T5426 | portacono | cones basket
cm Ø 7x14,5 | pz. conf. 1 | c/c 12







cm Ø13x4



cm Ø11x3,5



cm Ø9x3

€ 7,75



P1008 | set 3 ciotole in acciaio | *stainless steel bowls set* | pz. conf. 3 | c/c 24



€ 1,50



P1007.T | tappo per P1007 | *lid for P1007*
cm Ø8 | pz. conf. 1 | c/c 12



€ 8,90



P1007 | tumbler in acciaio | *stainless steel tumbler* | cm Ø8x11 | 340ml | pz. conf. 1 | c/c 24

aperitime
aperitime
aperitime
aperitime



cm Ø13x4



cm Ø11x3,5



cm Ø9x3

€ 8,00



P1009 | set 3 ciotole in acciaio | *stainless steel bowls set* | pz. conf. 3 | c/c 24



€ 8,25



P1010 | tazza moscow mule | *moscow mule mug*
| cm Ø8,5x10 | 420ml | pz. conf. 1 | c/c 24



€ 6,75



P2010 | tegamino | *mini pan* | cm Ø 10x4,25
| pz. conf. 1 | c/c 12



€ 12,11



P2004 | padellino | *mini pan*
cm Ø 12x4 | pz. conf. 1 | c/c 12



€ 11,25



P2000 | tegamino | *mini pan*
cm Ø 10x4,25 | pz. conf. 1 | c/c 12



€ 12,98



P2003 | casseruola | *casserole*
cm Ø 12x6 | pz. conf. 1 | c/c 12



€ 15,14



P2001 | tegamino | *mini pan*
cm Ø 13x4,25 | pz. conf. 1 | c/c 12



€ 9,63



P2002 | casseruola | *casserole* | cm Ø8,25x5 |
pz. conf. 1 | c/c 12





€ 15,43



P2109 | vassoio in acciaio | *stainless steel tray*
cm 20x11,5x1,3 | pz. conf. 1 | c/c 8



€ 23,70



P2112 | vassoio color rame | *copper-color tray*
cm 30,5x21x1,3 | pz. conf. 1 | c/c 6



€ 17,47



P2110 | vassoio color rame | *copper-color tray*
cm 25,5x11,5x1,3 | pz. conf. 1 | c/c 8



€ 24,52



P2113 | vassoio in acciaio | *stainless steel tray*
cm 30,5x21x1,3 | pz. conf. 1 | c/c 6



€ 20,08



P2111 | vassoio in acciaio | *stainless steel tray*
cm 25,5x11,5x1,3 | pz. conf. 1 | c/c 8



€ 31,53



P2114 | vassoio in acciaio | *stainless steel tray*
cm 50x11,5x1,3 | pz. conf. 1 | c/c 6





€ 13,48  **SS**

P2134 | ciotolina color rame | copper-color bowl | cm Ø7x5 | pz. conf. 1 | c/c 24 



€ 18,43  **SS**

P2135 | ciotolina color rame | copper-color bowl | cm Ø7x9 | pz. conf. 1 | c/c 24 



€ 12,21  **SS**

P2131 | ciotolina color rame | copper-color bowl | cm Ø8x6 | pz. conf. 1 | c/c 24 



€ 11,91  **SS**

P2133 | ciotolina color rame | copper-color bowl | cm Ø8x5 | pz. conf. 1 | c/c 24 



€ 13,20  **SS**

P2136 | secchiello color rame | copper-color basket | cm Ø10,8x8 | pz. conf. 1 | c/c 24 



€ 11,00  **SS**

P2132 | ciotolina color rame | copper-color bowl | cm 10x10x5 | pz. conf. 1 | c/c 24 



€ 15,95  **SS**

P2137 | secchiello color rame | copper-color basket | cm Ø11,2x10 | pz. conf. 1 | c/c 24 



€ 18,43  **SS**

P2138 | secchiello color rame | copper-color basket | cm Ø12x12 | pz. conf. 1 | c/c 24 





€ 10,73  

P2123 | coppetta cilindrica | *cylindrical cup*
cm Ø7x5 | pz. conf. 1 | c/c 24 



€ 17,33  

P2124 | coppetta cilindrica | *cylindrical cup*
cm Ø7x9 | pz. conf. 1 | c/c 24 



€ 10,73  

P2128 | ciotolina in acciaio | *stainless steel bowl*
cm Ø8x5 | pz. conf. 1 | c/c 24 



€ 10,87  

P2130 | ciotolina in acciaio | *stainless steel bowl*
cm Ø8x6 | pz. conf. 1 | c/c 24 



€ 9,90  

P2129 | ciotolina in acciaio | *stainless steel bowl*
cm 10x10x5 | pz. conf. 1 | c/c 24 



€ 11,83  

P2125 | secchiello in acciaio | *stainless steel basket*
cm Ø10,8x8 | pz. conf. 1 | c/c 24 



€ 14,85  

P2126 | secchiello in acciaio | *stainless steel basket*
cm Ø11,2x10 | pz. conf. 1 | c/c 24 



€ 17,33  

P2127 | secchiello in acciaio | *stainless steel basket*
cm Ø12x12 | pz. conf. 1 | c/c 24 

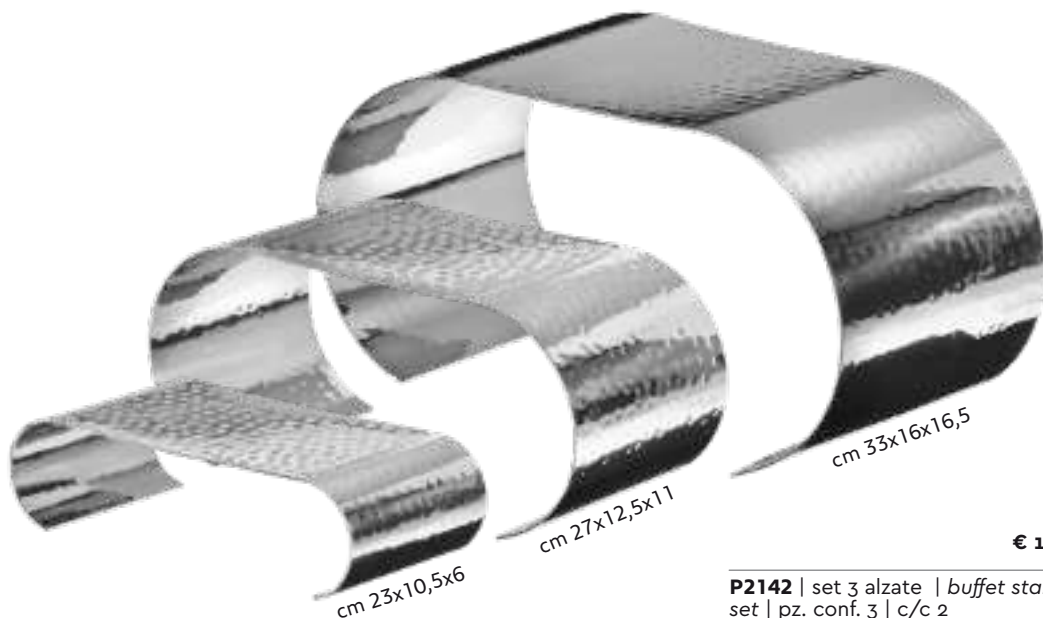

€ 122,09  

P2142 | set 3 alzate | buffet stand
set | pz. conf. 3 | c/c 2



acciaio martellato | hammered stainless steel

P2143 | ciotola quadrata | square
bowl | cm 13x13x7 | pz. conf. 1 | c/c 4
€ 24,66

P2144 | ciotola quadrata | square
bowl | cm 18x18x8,5 | pz. conf. 1 | c/c 4
€ 40,14

P2145 | ciotola quadrata | square
bowl | cm 24x24x10 | pz. conf. 1 | c/c 4
€ 59,09



doppia parete | double wall

P2141 | ciotola in acciaio | stainless
steel bowl | cm Ø25,5x12,5 |
pz. conf. 1 | c/c 4
€ 52,79

P2140 | ciotola in acciaio | stainless
steel bowl | cm Ø20x12 |
pz. conf. 1 | c/c 6
€ 35,51

P2139 | ciotola in acciaio | stainless
steel bowl | cm Ø15x9,5 |
pz. conf. 1 | c/c 6
€ 20,79





€ 10,94



P2120 | ciotola in acciaio | *stainless steel*
bowl | cm Ø 15x8 | pz. conf. 1 | c/c 12



€ 11,18



P2119 | ciotola color rame | *copper-color*
bowl | cm Ø 15x8 | pz. conf. 1 | c/c 12



€ 13,55



P2105 | ciotola in acciaio | *stainless steel*
bowl | cm Ø 20x10 | pz. conf. 1 | c/c 12



€ 14,42





P2104 | ciotola color rame | *copper-color*
bowl | cm Ø 20x10 | pz. conf. 1 | c/c 12



150 ACCIAIO MARTELLATO





€ 28,32  

P2122 | griglia per P2101 | ice grid for P2101
cm Ø 38,5 | pz. conf. 1 | c/c 3  



€ 21,45  

P2121 | griglia per P2100 | ice grid for P2100
cm Ø 28 | pz. conf. 1 | c/c 3  



€ 40,85  

P2101 | vassoio tondo | round tray
cm Ø 40 | pz. conf. 1 | c/c 6  



€ 31,53  

P2100 | vassoio tondo | round tray
cm Ø 30 | pz. conf. 1 | c/c 6  





€ 52,64



P2107 | secchiello ghiaccio | *ice bucket*
cm Ø 27x14 | pz. conf. 1 | c/c 4



€ 12,09



P1004 | moscow mule | *moscow mule*
ml. 590 | pz. conf. 1 | c/c 24



€ 97,60



P2106 | secchiello ghiaccio | *ice bucket*
cm Ø 37,5x17 | pz. conf. 1 | c/c 2



€ 25,36



P2103 | glacette | *wine cooler*
cm Ø 12x18,5 | pz. conf. 1 | c/c 8



€ 92,02



P2108 | secchiello ghiaccio | *ice bucket*
cm Ø 43x17,5 | pz. conf. 1 | c/c 2



€ 33,94



P2102 | secchiello ghiaccio | *wine bucket*
cm Ø 23x21,5 | pz. conf. 1 | c/c 6





€ 5,46



T5091 | portaghiaccio | *ice bucket*
cm Ø 14x13 | pz. conf. 1 | c/c 24



€ 12,18



T5012.T | secchiello acrilico | *acrylic ice bucket*
| lt. 3,5 | pz. conf. 1 | c/c 20



€ 13,88



P1005 | secchiello portaghiaccio | *ice bucket*
cm 22x20 | pz. conf. 1 | c/c 12



€ 19,97



T5092 | glacette acciaio | *stainless steel cooler*
| cm Ø 12x19,5 | pz. conf. 1 | c/c 24



€ 13,88



P1006 | secchiello portaghiaccio | *ice bucket*
cm 22x20 | pz. conf. 1 | c/c 12



€ 18,98



T5506 | portaghiaccio | *ice bucket*
cm 20/23,6x20 | pz. conf. 1 | c/c 12



€ 59,36



P1011 | colonna porta secchiello | *wine bucket holder*
| cm Ø19x72 | pz. conf. 1 | c/c 3



€ 59,56



T5090 | secchiello champagne | *champagne bowl*
| cm Ø 39x25 | pz. conf. 1 | c/c 2





€ 17,55

T5508 | caraffa in metacrilato |
methacrylate pitcher | lt. 1,7 |
pz. conf. 1 | c/c 12



€ 23,32

T5507 | caraffa metacrilato |
methacrylate pitcher | lt. 1,6 |
pz. conf. 1 | c/c 12



€ 17,45

T5501 | caraffa trasparente |
transparent pitcher | lt. 1,7 |
pz. conf. 1 | c/c 12



€ 31,16

T5502 | caraffa in metacrilato |
methacrylate pitcher | lt. 1,8 |
pz. conf. 1 | c/c 6



€ 31,90

T5506 | caraffa policarbonato |
polycarb. pitcher | lt. 2 | pz. conf. 1 |
c/c 12



€ 6,02

T5504 | caraffa trasparente |
transparent pitcher | lt. 0,95 |
pz. conf. 1 | c/c 12



€ 9,18

T5505 | caraffa trasparente |
transparent pitcher | lt. 1,7 |
pz. conf. 1 | c/c 12



€ 9,90

T5510 | caraffa in metacrilato |
methacrylate jug | cm Ø10x27
lt. 1,5 | pz. conf. 1 | c/c 12



€ 8,10

T5509 | caraffa in metacrilato |
methacrylate jug | cm Ø8x22,5
lt. 1 | pz. conf. 1 | c/c 12





€ 23,60

G5023 | bicchiere Elegance | glass Elegance | ml 360 | pz. conf. 6 | c/c 3



€ 37,92

G5002 | flute Perlage | flute Perlage | ml 240 | pz. conf. 6 | c/c 3



€ 30,38

G5021 | flute Petit Perlage | flute Petit Perlage | ml 160 | pz. conf. 6 | c/c 3



€ 37,92

G5000 | calice Wine Cocktail | glass Wine Cocktail | ml 470 | pz. conf. 6 | c/c 3



€ 37,92

G5001 | calice Redone | glass Redone | ml 510 | pz. conf. 6 | c/c 3



€ 33,44

G5033 | bicchiere Ballon mix | glass Ballon | ml 580 | pz. conf. 6 | c/c 3



€ 6,98

G2763PP | bicchiere Granity | glass Granity | ml 400 | pz. conf. 5 | c/c 15



€ 8,68

G2764PP | bicchiere Rox | glass Rox | ml 290 | pz. conf. 8 | c/c 15



€ 8,99

G2763 | bicchiere Granity | glass Granity | ml 400 | pz. conf. 5 | c/c 15



€ 11,90

G2764 | bicchiere Rox | glass Rox | ml 290 | pz. conf. 8 | c/c 15



Nell'ottica di contribuire alla salvaguardia dell'ambiente, Leone Srl propone nuovi bicchieri infrangibili per acqua, vino, cocktail e birra.

L'utilizzo di tecno-polimeri di ultima generazione rende i bicchieri sicuri e resistenti, ma allo stesso tempo eleganti e di design.

In order to make a contribution to the environmental preservation, Leone srl introduce new shatterproof glassware for water, wine, cocktails and beer.

Thanks to the use of the latest generation of techno-polymers, the glassware are safe and resistant, but elegant and stylish at the same time.

PBA free





€ 3,40  Fe

T5084 | mini secchiello in latta | *small tin bucket* | cm Ø 12x10,8 | pz. conf. 1 | c/c 24 



€ 2,08  Fe

P3000 | secchiello in latta | *tin bucket* | cm 12,2x7 | pz. conf. 1 | c/c 36 



€ 4,19  Fe

T5085 | mini secchiello in latta | *small tin bucket* | cm Ø 13x12 | pz. conf. 1 | c/c 24 



€ 6,31  Fe

T5083 | vaschetta in latta | *tin basin* | cm 23x15x8 | pz. conf. 1 | c/c 6 



€ 21,10  Fe

T5081 | secchiello ghiaccio | *ice tin basin* | lt. 16 | pz. conf. 1 | c/c 6 



€ 10,35  Fe

T5080 | secchiello ghiaccio | *ice tin basin* | lt. 5 | pz. conf. 1 | c/c 12 



€ 13,86  Fe

P3004 | secchiello in latta | *tin bucket* | cm 24,5x17,5x13,3 | pz. conf. 1 | c/c 12 



€ 6,93  Fe

P3003 | secchiello in latta | *tin bucket* | cm 16,5x12,5x11 | pz. conf. 1 | c/c 12 





€ 4,90  

P3019 | vassoio ovale in latta | *oval tin tray*
cm 31x23x2 | pz. conf. 1 | c/c 12



€ 1,60  

P3023 | vasetto in latta | *tin bowl*
cm 8x5x7 | pz. conf. 1 | c/c 48



€ 8,50  

P3018 | vassoio ovale in latta | *oval tin tray*
cm 36,5x26 | pz. conf. 1 | c/c 8



€ 2,00  

P3007 | tazza in latta | *tin mini mug*
cm Ø 5x5 | pz. conf. 1 | c/c 72



€ 3,15  

P3011 | pentolino in latta | *tin pot* | cm Ø
8x4,5 | pz. conf. 1 | c/c 48



€ 3,36  

P3008 | tazza in latta | *tin mini mug*
cm Ø 9x9 | pz. conf. 1 | c/c 48



€ 3,99  

P3012 | pentolino in latta | *tin pot* | cm Ø
11x4,5 | pz. conf. 1 | c/c 36



€ 2,05  

P3009 | tazza in latta | *tin mug*
cm Ø 10x10 | pz. conf. 1 | c/c 36



€ 6,30  

P3013 | pentolino in latta | *tin pot* | cm Ø
14x5 | pz. conf. 1 | c/c 36



€ 3,00  

P3010 | tazza in latta | *tin mug*
cm Ø 12x12 | pz. conf. 1 | c/c 36





€ 6,50



P3022 | vaso in latta | *tin vase*
cm 10x11x15 | pz. conf. 1 | c/c 12



€ 3,25



P3015 | vassoio in latta | *tin tray*
cm 16x12x3,5 | pz. conf. 1 | c/c 24



€ 3,75



P3016 | vassoio in latta | *tin tray*
cm 20x14,5x4,3 | pz. conf. 1 | c/c 12



€ 5,10



P3017 | vassoio in latta | *tin tray*
cm 26x19x5,5 | pz. conf. 1 | c/c 12



€ 6,90



P3024 | piatto in latta | *tin plate*
cm 25x25x3,9 | pz. conf. 1 | c/c 12



€ 5,94  **SS**

T5601 | miscelatore | *bar spoon*
cm 30 | pz. conf. 1 | c/c 20



€ 8,27  **SS**

T5603 | pinza da chef | *giant tweezer*
cm 30 | pz. conf. 1 | c/c 10



€ 5,09  **SS**

T5094 | misurino cocktail | *jigger*
ml. 20/40 | pz. conf. 1 | c/c 24



€ 5,19  **Abs**

T5600 | pestello in abs | *abs pestle*
cm 20 | pz. conf. 1 | c/c 12



€ 4,41  **SS**

T5088 | cucchiaino colino | *strainer spoon*
cm 23 | pz. conf. 1 | c/c 96



€ 5,94  **SS**

T5602 | colino per shaker | *bar strainer*
pz. conf. 1 | c/c 12



€ 23,24  **SS**

T5606 | shaker c/bicchieri | *boston shaker with glass* | ml. 830 | pz. conf. 1 | c/c 12



€ 10,70  **SS**

T5605 | shaker c/bicchieri | *boston shaker with glass* | ml. 830 | pz. conf. 1 | c/c 12  **Gl**



€ 15,22  **SS**

T5086 | shaker in acciaio | *stainless steel shaker* | ml. 700 | pz. conf. 1 | c/c 30



€ 2,97  **Gl**

T5607 | bicchiere da shaker | *glass for shaker*
ml. 480 | pz. conf. 1 | c/c 16



€ 1,70  SS

T5072 | apribottiglia da muro | wall bottle opener | | pz. conf. 1 | c/c 24



€ 3,54  SS

T5608 | tappo da champagne | champagne stopper | | pz. conf. 1 | c/c 20



€ 11,79  SS

T5051 | beccuccio versa liquidi | chrome pourer | | pz. conf. 6 | c/c 10

PP



€ 2,87  SS

T5071 | apribottiglia | corkscrew
pz. conf. 1 | c/c 12



€ 15,81  PP

T5066 | flair bottle | flair bottle
cm 28 | pz. conf. 1 | c/c 24





€ 8,18  Abs

T5040 | bar organizer | bar organizer
cm 15x22x10 | pz. conf. 1 | c/c 12



€ 30,50  SS

T5077 | dispenser portabottiglie | dispenser
for bottle | cm 55x10x16 | pz. conf. 1 | c/c 6



€ 21,09  PP

T5059 | portaccondimenti | condiment holder
cm 14x30x9 | pz. conf. 1 | c/c 12



€ 14,29  Abs

T5044 | bordatore per bicchieri | glass
rimmer cm Ø 15,5 | pz. conf. 1 | c/c 24



€ 30,15  PP

T5058 | portaccondimenti | condiment holder
cm 46x15x10 | pz. conf. 1 | c/c 12



€ 30,15  PP

T5057 | portaccondimenti | condiment holder
cm 38x15x10 | pz. conf. 1 | c/c 16



€ 40,80  PP

T5042 | portaccondimenti | condiment holder
cm 50x15,5x9 - 600 ml | pz. conf. 1 | c/c 12



€ 40,80  PP

T5043 | portaccondimenti | condiment holder
cm 50x15,5x9 - 400 ml | pz. conf. 1 | c/c 12





€ 6,93  

T5048 | pour master completo | *pour & store*
lt. 1 | pz. conf. 1 | c/c 12



€ 2,60  

T5047 | pour master completo | *pour & store*
lt. 0,5 | pz. conf. 1 | c/c 36



€ 4,02  

T5004 | paletta piccola | *small scoop*
cm 26x9x4 | pz. conf. 1 | c/c 72



€ 16,87  

T5604 | spremi lime | *lime squeezer*
pz. conf. 1 | c/c 12



€ 6,31  

T5021 | vassoio antiscivolo | *antislip rubber tray*
cm Ø 36 | pz. conf. 1 | c/c 12



€ 13,49  

T5045 | tappetino gomma | *rubber mat*
cm 60x8 | pz. conf. 1 | c/c 50



€ 8,69  

T5023 | vassoio antiscivolo | *antislip rubber tray*
cm Ø 40 | pz. conf. 1 | c/c 12



€ 16,93  

T5046 | tappetino gomma | *rubber mat*
cm 30x40 | pz. conf. 1 | c/c 20



€ 6,31  

T5020 | vassoio antiscivolo | *antislip rubber tray*
cm 25x35 | pz. conf. 1 | c/c 12



€ 8,87  

T5022 | vassoio antiscivolo | *antislip rubber tray*
cm 35x45 | pz. conf. 1 | c/c 12





- | | |
|---|----------------|
| T5005 squeeze bottle trasparenze <i>trans. squeeze bottle</i> ml. 500 pz. conf. 1 c/c 36 | € 2,28 |
| T5006 squeeze bottle trasparenze <i>trans. squeeze bottle</i> ml. 950 pz. conf. 1 c/c 24 | € 3,21 |
| T5013.I squeeze bottle gialla <i>yellow squeeze bottle</i> ml. 230 pz. conf. 6 c/c 12 | € 8,25 |
| T5013.M squeeze bottle rossa <i>red squeeze bottle</i> ml. 230 pz. conf. 6 c/c 12 | € 8,25 |
| T5013.T squeeze bottle trasparenze <i>trans. squeeze bottle</i> ml. 230 pz. conf. 6 c/c 12 | € 8,25 |
| T5014.I squeeze bottle gialla <i>yellow squeeze bottle</i> ml. 680 pz. conf. 6 c/c 4 | € 16,00 |
| T5014.M squeeze bottle rossa <i>red squeeze bottle</i> ml. 680 pz. conf. 6 c/c 4 | € 16,00 |
| T5014.T squeeze bottle trasparenze <i>trans. squeeze bottle</i> ml. 680 pz. conf. 6 c/c 4 | € 16,00 |
| T5015.I2 squeeze bottle gialla <i>yellow squeeze bottle</i> ml. 340 pz. conf. 6 c/c 6 | € 10,70 |
| T5015.M2 squeeze bottle rossa <i>red squeeze bottle</i> ml. 340 pz. conf. 6 c/c 6 | € 10,70 |
| T5015.T2 squeeze bottle trasparenze <i>trans. squeeze bottle</i> ml. 340 pz. conf. 6 c/c 6 | € 10,70 |



€ 13,19  

T0508 | cestino americano | *american basket* cm 23,5x15x4,6 | pz. conf. 12 | c/c 12



€ 16,01  

T0509 | cestino americano | *american basket* cm 27,5x17,5x3,8 | pz. conf. 12 | c/c 12





€ 5,02  **SS**

P4007 | set coppapasta tondi | *round food ring* | cm Ø 6- 8- 10,5x4,5 | pz. conf. 3 | c/c 24



€ 5,02  **SS**

P4008 | set coppapasta quadrati | *square food ring* | cm 6- 8- 10x4,5 | pz. conf. 3 | c/c 24



€ 8,14  **PVC**

T5011 | copribottiglie refrig. | *bottle cooler* | cm 18,5 | pz. conf. 1 | c/c 24



€ 5,95  **SS**

T5408 | portatovagliolo | *napkin holder* | cm 17x3x8 | pz. conf. 1 | c/c 24



€ 3,96  **SS**

T5401 | portauovo | *egg cup* | cm 10x3 | pz. conf. 1 | c/c 96



€ 3,40  **SS**

T5074 | pinza in acciaio | *stainless steel tong* | cm 18 | pz. conf. 1 | c/c 40



€ 5,00  **SS**

T5075 | pinza in acciaio | *stainless steel tong* | cm 22 | pz. conf. 1 | c/c 24



€ 1,90  **SS**

T5063 | molla per ghiaccio | *ice tong* | cm 20 | pz. conf. 1 | c/c 12



€ 6,25  

S0078 | portarifiuti in bamboo | *bamboo table bin* | cm 11x11x11 | pz. conf. 1 | c/c 24



€ 14,80  

T5000.2 | vaschetta portabustine | *sachet holder* | cm 8x5x5 | pz. conf. 12 | c/c 12



€ 14,23  

T5409 | portarifiuti da tavola | *table bin* | cm 12x16 | pz. conf. 1 | c/c 24



€ 17,55  

S0079 | portabustine | *sachet holder* | m 7x11x5,5 | pz. conf. 6 | c/c 6



€ 3,40  

T5027 | secchiello bianco | *white bucket* | cm Ø 13x17 - 1 | | pz. conf. 1 | c/c 24



€ 2,79  

T8218 | portabustine | *sachet holder* | cm 9x6x5 | pz. conf. 1 | c/c 48



€ 3,40  

T5026 | secchiello tortora | *dove grey bucket* | cm Ø 13x17 - 1 | | pz. conf. 1 | c/c 24



€ 14,80  

T5000.Y2 | vaschetta portabustine | *sachet holder* | cm 8x5x5 | pz. conf. 12 | c/c 12



€ 4,75  

T5007N | portarifiuti da tavola | *table bin* | cm Ø 11x14 | pz. conf. 1 | c/c 48



€ 14,80  

T5000.Z2 | vaschetta portabustine | *sachet holder* | cm 8x5x5 | pz. conf. 12 | c/c 12



€ 1,60  Fe

T1028 | portabustine journal | *journal sachet holder* | cm 11x6,2x5,4 | pz. conf. 1 | c/c 48



€ 1,60  Fe

T1029 | portabustine vintage | *vintage sachet holder* | cm 11x6,2x5,4 | pz. conf. 1 | c/c 48



€ 4,75  Fe

T1039 | vassoio vintage | *vintage tray* | cm Ø 32 | pz. conf. 1 | c/c 18



€ 4,75  Fe

T1038 | vassoio journal | *journal tray* | cm Ø 32 | pz. conf. 1 | c/c 18



€ 5,00  Fe

P3005 | set cestini in latta | *tin bucket set* | cm 12x12 | pz. conf. 3 | c/c 12



€ 6,26



Fe

T1008 | portatovaglioli journal | *journal napkin holder* | cm 10x9x13 | pz. conf. 1 | c/c 24



€ 4,50



SS

T1004.A | portatovaglioli Vivaldi | *napkin holder Vivaldi* | cm 10,6x9,6x13,9 | pz. conf. 1 | c/c 24



€ 6,26



Fe

T1009 | portatovaglioli vintage | *vintage napkin holder* | cm 10x9x13 | pz. conf. 1 | c/c 24



€ 4,50



SS

T1004.V | portatovaglioli Verdi | *napkin holder Verdi* | cm 10,6x9,6x13,9 | pz. conf. 1 | c/c 24



€ 6,26



Fe

T1007 | portatovaglioli silver | *silver napkin holder* | cm 10x9x13 | pz. conf. 1 | c/c 24



€ 4,50



SS

T1004.P | portatovaglioli Paganini | *napkin holder Paganini* | cm 10,6x9,6x13,9 | pz. conf. 1 | c/c 24



€ 7,53



SS

T1005.K | portatovaglioli argento | *silver napkin holder* | cm 10x9x13 | pz. conf. 1 | c/c 24



€ 7,53



SS

T1005.Z | portatovaglioli nero | *black napkin holder* | cm 10x9x13 | pz. conf. 1 | c/c 24



€ 4,40



portatovaglioli kristal | *kristal napkin holder* |
cm 10x7x13 | pz. conf. 1 | c/c 48
T1001 | *transparent* **T1001.Z** | *black*

con coperchio
with lid



€ 5,25



portatovaglioli kristal | *kristal napkin holder* |
cm 10x7x13 | pz. conf. 1 | c/c 48
T1002 | *transparent* **T1002.Z** | *black*



€ 6,30



T1003.M | portatovaglioli rosso | *red napkin holder* |
cm 10x11x13 | pz. conf. 1 | c/c 48



€ 6,30



T1003.Z | portatovaglioli nero | *black napkin holder* |
cm 10x11x13 | pz. conf. 1 | c/c 48



€ 6,30



T1003.Y | portatovaglioli bianco | *white napkin holder* |
cm 10x11x13 | pz. conf. 1 | c/c 48



T5095.N | parananza bordeaux | *bordeaux twill apron* | cm 59x30 | pz. conf. 1 | c/c 24 € 4,70

T5095.Y | parananza bianca | *white twill apron* cm 59x30 | pz. conf. 1 | c/c 24 € 4,70

T5095.Z | parananza nera | *black twill apron* cm 59x30 | pz. conf. 1 | c/c 24 € 8,55

T5096.N | grembiule bordeaux | *bordeaux twill apron* | cm 72x84 | pz. conf. 1 | c/c 36 € 10,63

T5096.Z | grembiule nero | *black twill apron* cm 72x84 | pz. conf. 1 | c/c 36 € 10,63



€ 5,97  

T5041.Z | rotolo antiscivolo | *antislip mat* cm 30x110 | pz. conf. 1 | c/c 25



€ 3,58  

T5017 | tagliere piccolo | *small chopping* cm 16x22x1 | pz. conf. 1 | c/c 40



€ 7,32  

T5018 | tagliere medio | *medium chopping* cm 22x29x1 | pz. conf. 1 | c/c 30



€ 10,50  

T5019 | tagliere grande | *big chopping* cm 29x44x1 | pz. conf. 1 | c/c 18





€ 9,53  

T5102 proof 220 | guanto forno | oven mitt
cm 61 | pz. conf. 1 | c/c 12



€ 6,59  

T5101 proof 220 | guanto forno | oven mitt
cm 38 | pz. conf. 1 | c/c 12



€ 16,38  

T5104 proof 320 | guanto forno | oven mitt
cm 61 | pz. conf. 1 | c/c 12



€ 9,79  

T5103 proof 320 | guanto forno | oven mitt
cm 38 | pz. conf. 1 | c/c 12



€ 6,78  

T5099 easy 100 | guanto forno | oven mitt
cm 61 | pz. conf. 1 | c/c 12



€ 4,42  

T5098 easy 100 | guanto forno | oven mitt
cm 38 | pz. conf. 1 | c/c 12



doubleface

€ 3,87  

T5121 proof 220 | presina da forno | pot
holder





W
Ce SS

€ 6,95

T4209 | macina avorio |
ivory mill | cm 25 |
pz. conf. 1 | c/c 24



W
Ce SS

€ 6,95

T4206 | macina azzurro |
light blue mill | cm 25 |
pz. conf. 1 | c/c 24



W
Ce SS

€ 6,95

T4214 | macina rosso |
red mill | cm 25 |
pz. conf. 1 | c/c 24



W
Ce Ac

€ 12,97

T4202 | macina
trasparente | *transparent
mill* | cm 30 | pz. conf. 1 |
c/c 24

Utilizziamo
macine in
ceramica
resistenti alla
corrosione del
sale. Forniti privi
di contenuto.
*We use only
ceramic mills
corrosion
resistant grindet.
These items are
supplied empty.*



W
Ce !

€ 6,20

T4205 | macina azzurro |
light blue mill | cm 20 | pz.
conf. 1 | c/c 24



W
Ce SS

€ 13,27

T4203 | macina legno |
wood mill | cm 20 |
pz. conf. 1 | c/c 24



W
Ce Ac

€ 8,49

T4201 | macina trasparente
| *transparent mill* | cm 20 |
pz. conf. 1 | c/c 24



W
Ce !

€ 4,40

T4212 | macina rosso | *red
mill* | cm 15 | pz. conf. 1 |
c/c 48



W
Ce SS

€ 4,40

T4204 | macina azzurro |
light blue mill | cm 15 |
pz. conf. 1 | c/c 48



W
Ce SS

€ 11,45

T4215 | macina legno |
wood mill | cm 15 |
pz. conf. 1 | c/c 24



W
Ce Ac

€ 5,20

T4200 | macina
trasparente | *transparent
mill* | cm 10 | pz. conf. 1 |
c/c 48





€ 23,80



T3012 | vasetto in vetro | *glass vase*
cm Ø 7,5x8 - 150 ml | pz. conf. 12 | c/c 4



€ 19,00



T3010 | vasetto in vetro | *glass vase*
cm Ø 6x7 - 100 ml | pz. conf. 12 | c/c 4



€ 20,70



T3011 | vasetto in vetro | *glass vase*
cm Ø 6,5x9 - 150 ml | pz. conf. 12 | c/c 4



€ 29,20



T3013 | vasetto in vetro | *glass vase*
cm Ø 8,2x8 - 200 ml | pz. conf. 12 | c/c 4



€ 8,80



T3016 | vasetto con lavagna | *blackboard jar*
cm Ø 11x9,4 - 500 ml | pz. conf. 6 | c/c 4



€ 14,45



T3015 | vasetto in vetro | *glass vase*
cm Ø 11x10 - 400 ml | pz. conf. 4 | c/c 6





€ 8,34



T3203 | bicchierino Fiji | *small glass Fiji*
cm Ø 5,7x5,7x4 - 70 ml | pz. conf. 6 | c/c 10



€ 10,55



T3201 | bicchierino Maui | *small glass Maui*
cm Ø 5,3x5 - 110 ml | pz. conf. 6 | c/c 10



€ 10,87



T3204 | bicchierino Samoa | *small glass Samoa*
cm Ø 7,5x5 - 100 ml | pz. conf. 6 | c/c 10



€ 10,99



T3202 | bicchierino Tonga | *small glass Tonga*
cm Ø 7,8x5,7 - 42 ml | pz. conf. 6 | c/c 10



€ 9,67



T3205 | bicchierino Tahiti | *small glass Tahiti*
cm Ø 4,7x6,8 - 70 ml | pz. conf. 6 | c/c 10



€ 10,08



T3200 | bicchierino Hilo | *small glass Hilo*
cm Ø 6,8x4,7 - 110 ml | pz. conf. 6 | c/c 10





€ 29,17



T3023 | big jar c/supporto | big jar with tin base | lt. 3 | pz. conf. 1 | c/c 4



€ 66,27



T3025 | big jar c/base in acacia | jar with acacia base | lt. 5,8 | pz. conf. 1 | c/c 4



€ 42,78



T3022 | big jar c/supporto | big jar with tin base | lt. 6 | pz. conf. 1 | c/c 4



€ 36,40



T3026 | jar con base in bamboo | jar with bamboo base | lt. 5,6 | pz. conf. 1 | c/c 4





€ 4,55  

T3102.M | tortiera Wild Flower | cakestand
Wild Flower | cm Ø 25,5x9,3 | pz. conf. 1 | c/c 8



€ 6,20  

T3102.L | tortiera Wild Flower | cakestand
Wild Flower | cm Ø 31x9,3 | pz. conf. 1 | c/c 4



€ 3,72  

T3024 | rubinetto per jar | tap for jar t3022
t3023 | | pz. conf. 3 | c/c 48



€ 6,34  

T3018 | barattolo in vetro | glass jar with lid
cm Ø 14,8x17,3 - 1,25 lt | pz. conf. 1 | c/c 12



€ 9,32  

T3019 | barattolo in vetro | glass jar with lid
cm Ø 15x24 - 2,2 lt | pz. conf. 1 | c/c 6





€ 12,21  PET

T2218 | tovaglietta Disco | placemat Disco
cm Ø 38 | pz. conf. 4 | c/c 10



€ 15,27  PP

T2221.P4 | tovaglietta Les Chic | placemat
Les Chic | cm 43x30 | pz. conf. 4 | c/c 10



€ 15,27  PP

T2221.Z4 | tovaglietta Les Chic | placemat
Les Chic | cm 43x30 | pz. conf. 4 | c/c 10





€ 6,80



T2223 | tovaglietta Happy Farm | placemat
Happy Farm | cm 38x36 | pz. conf. 4 | c/c 10



€ 14,90



T2211.M12 | tovaglietta Playa | placemat
Playa | cm 30x45 | pz. conf. 12 | c/c 10



€ 14,90



T2211.R12 | tovaglietta Playa | placemat
Playa | cm 30x45 | pz. conf. 12 | c/c 10



€ 14,90



T2211.V12 | tovaglietta Playa | placemat
Playa | cm 30x45 | pz. conf. 12 | c/c 10



€ 30,66



T2200.P12 | tovaglietta Tundra | dark grey
placemat Tundra | cm 30x45 | pz. conf. 12 |
c/c 10



€ 9,50



T2217 | tovaglietta Mare | placemat Sea
cm 30x45 | pz. conf. 12 | c/c 10



€ 30,66



T2200.U12 | tovaglietta Tundra | brown placemat
Tundra | cm 30x45 | pz. conf. 12 | c/c 10



€ 4,20



PVC



T2213.Z | runner Style | runner Style
cm 40x120 | pz. conf. 1 | c/c 24



€ 4,20



PVC

T2213.Y | runner Style | runner Style
cm 40x120 | pz. conf. 1 | c/c 24



€ 4,20



PVC

T2213.P | runner Style | runner Style
cm 40x120 | pz. conf. 1 | c/c 24



€ 4,20



PVC

T2213.R | runner Style | runner Style
cm 40x120 | pz. conf. 1 | c/c 24





€ 8,61  

T2204.P | runner Savana | *brown runner Savana* | cm 40x120 | pz. conf. 1 | c/c 24



€ 30,66  

T2203.P12 | tovaglietta Savana | *brown placemat Savana* | cm 30x45 | pz. conf. 12 | c/c 10



€ 8,61  

T2204.T | runner Savana | *grey runner Savana* | cm 40x120 | pz. conf. 1 | c/c 24



€ 30,66  

T2203.T12 | tovaglietta Savana | *grey placemat Savana* | cm 30x45 | pz. conf. 12 | c/c 10



€ 8,61  

T2204.R | runner Savana | *sand runner Savana* | cm 40x120 | pz. conf. 1 | c/c 24



€ 30,66  

T2203.R12 | tovaglietta Savana | *sand placemat Savana* | cm 30x45 | pz. conf. 12 | c/c 10







€ 9,50  

T2216 | tovaglietta Foglie | placemat Leaf
cm 30x45 | pz. conf. 12 | c/c 10



€ 3,42  

S0071 | tovagliette sushi | sushi placemat |
cm 45x30 | pz. conf. 2 | c/c 48



€ 8,90  

T2206.A12 | tovaglietta Provenza | placemat
Provenza | cm 30x45 | pz. conf. 12 | c/c 10



€ 11,90  

T2215 | tovaglietta Vintage | placemat
Vintage | cm 30x45 | pz. conf. 12 | c/c 10

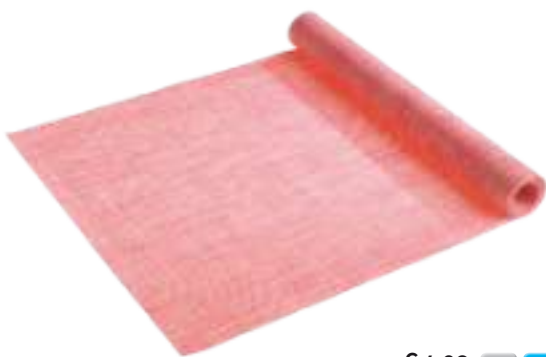

€ 4,20  

T2207.A | runner Provenza | runner Provenza
cm 40x120 | pz. conf. 1 | c/c 24



€ 30,66  

T2214.Z12 | tovaglietta Wood | placemat
Wood | cm 30x45 | pz. conf. 12 | c/c 4



€ 30,66  

T2214.R12 | tovaglietta Wood | placemat
Wood | cm 30x45 | pz. conf. 12 | c/c 4



€ 4,20  

T2207.R | runner Provenza | runner Provenza
cm 40x120 | pz. conf. 1 | c/c 24



€ 30,66  

T2214.P12 | tovaglietta Wood | placemat
Wood | cm 30x45 | pz. conf. 12 | c/c 4

NEW YORK



€ 10,50

T7053.T | portamenu grigio | *grey menu holder* | cm 24x32 - A4 | pz. conf. 1 | c/c 12

MIAMI



€ 9,90

T7050.T | portamenu grigio | *grey menu holder* | cm 24x32 - A4 | pz. conf. 1 | c/c 12

MADEIRA



€ 7,95

T7060.F | portamenu azzurro | *light blue menu holder* | cm 25x32 - A4 | pz. conf. 1 | c/c 20

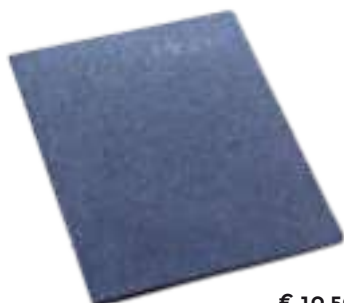

€ 10,50

T7053.G | portamenu blu | *blue menu holder* | cm 24x32 - A4 | pz. conf. 1 | c/c 12



€ 9,90

T7050.R | portamenu marrone | *brown menu holder* | cm 24x32 - A4 | pz. conf. 1 | c/c 12



€ 7,95

T7060.G | portamenu blu | *blue menu holder* | cm 25x32 - A4 | pz. conf. 1 | c/c 20



€ 10,50

T7053.Z | portamenu nero | *black menu holder* | cm 24x32 - A4 | pz. conf. 1 | c/c 12



€ 9,90

T7051 | carta dei vini beige | *beige wine list* | cm 24x32 - A4 | pz. conf. 1 | c/c 12



€ 7,95

T7061 | carta dei vini blu | *blue wine list* | cm 25x32 - A4 | pz. conf. 1 | c/c 20



€ 10,50

T7054 | carta dei vini marrone | *brown wine card holder* | cm 24x32 - A4 | pz. conf. 1 | c/c 12



€ 7,95

T7066 | portaconto azzurro | *light blue bill holder* | cm 22x12,5 | pz. conf. 1 | c/c 24



MIAMI / NEW YORK

portamenu/carta dei vini/
portaconto
in polipropilene
per 6 fogli A4 (12 facciate)
polypropylen menu holder/
wine list/
bill holder for 6
A4 sheet (12 pages)



MADEIRA

Portamenu in ecopelle
6 buste / 12 pagine
con elastico ferma fogli
Leatherette menu holder
6 envelopes / 12 pages
with elastic





€ 7,95

T7056.R | portamenu
marrone | *brown menu
holder* | cm 25x32 - A4 |
pz. conf. 1 | c/c 20



€ 7,95

T7056.Z | portamenu
grigio scuro | *dark grey
menu holder* | cm 25x32 -
A4 | pz. conf. 1 | c/c 20



€ 7,95

T7056.N | portamenu
rosso | *red menu holder* |
cm 25x32 - A4 | pz. conf. 1 |
c/c 20



€ 7,95

T7056.T | portamenu
grigio | *grey menu holder* |
cm 25x32 - A4 | pz. conf. 1 |
c/c 20



€ 7,95

T7057 | carta dei vini rossa
| *red wine list* | cm 25x32 -
A4 | pz. conf. 1 | c/c 20



€ 7,95

T7058.F | portamenu
azzurro | *light blue menu
holder* | cm 25x32 - A4 |
pz. conf. 1 | c/c 20



€ 7,95

T7058.T | portamenu
grigio | *dovegrey menu
holder* | cm 25x32 - A4 |
pz. conf. 1 | c/c 20



€ 6,90

T7068 | portaconto jeans |
jeans bill holder |
cm 22x12,5 | pz. conf. 1 |
c/c 24



€ 15,34

T7045.Z | portamenu
Toledo | *menu holder
Toledo* | cm 25x32 - A4 |
pz. conf. 1 | c/c 20



€ 4,61

T7012 | porta comande |
orders folder | cm 11x23 |
pz. conf. 1 | c/c 50



LISBONA



portamenu/carta dei vini in ecopelle
6 buste / 12 pagine A4
con chiodini ferma fogli
*polypropylen leatherette menu holder/
wine list/bill holder*
6 envelopes / 12 pages A4 with nail

TEXAS



portamenu in ecopelle
6 buste / 12 pagine A4
con elastico ferma fogli
polypropylen leatherette menu holder
6 envelopes / 12 pages with elastica

**W**

€ 9,19

S0076 | porta numero | *number holder* | cm 6x4x6 | pz. conf. 6 | c/c 12**Pa**

€ 9,50

T6007.OA | numeri da tavolo 1/25 | *number cardboard 1/25* | cm 8,5x5 | pz. conf. 2x25 | c/c 50**SS**

€ 3,60

T5416 | portanumero da tavolo | *card holder* | cm 7x20 | pz. conf. 1 | c/c 12**Ac**

€ 2,75

T5228 | supporto | *card stand* | cm 8,5x5 | pz. conf. 1 | c/c 100**Pa**

€ 9,50

T6007.OB | numeri da tavolo 26/50 | *number cardboard 26/50* | cm 8,5x5 | pz. conf. 2x25 | c/c 50**Pa**

€ 46,00

T6005 | comanda autocopiante | *holder sheets* | cm 10,2x21,4 | pz. conf. 500 | c/c 5**Pa**

€ 10,05

T6112 | cartoncino Vintage | *cardboard Vintage* | cm 8,5x5 | pz. conf. 50 | c/c 50**Pa !**

€ 9,50

T6007.OC | numeri da tavolo 51/75 | *number cardboard 51/75* | cm 8,5x5 | pz. conf. 2x25 | c/c 50**SS**

€ 4,32

T5076 | spillone per ordinazioni | *pin for orders* | cm 16 | pz. conf. 1 | c/c 12**SS**

€ 1,57

T5417 | portanumero da tavolo | *card holder* | cm 5,8x6 | pz. conf. 1 | c/c 12**Pa !**

€ 9,50

T6007.OD | numeri da tavolo 76/100 | *number cardboard 76/100* | cm 8,5x5 | pz. conf. 2x25 | c/c 50autocopiante
*carbonless***Pa**

€ 33,50

T6004 | blocco 100 fogli | *100 sheets block* | cm 10x14,5 | pz. conf. 10 | c/c 4



€ 9,30  

T5252 | lavagnetta windy | chalkboard
Windy | cm 31x23x3 | pz. conf. 1 | c/c 24



€ 10,31  

S0302 | lavagna con molletta | chalkboard
peg | cm 7,5x5 | pz. conf. 24 | c/c 12



€ 3,45  

S0301 | spiedi lavagna | blackboard stick
cm 16,5 | pz. conf. 50 | c/c 20



€ 7,02  

S0300 | spiedi lavagna | blackboard stick
cm 12 | pz. conf. 50 | c/c 20



€ 8,27  

S0304 | mini lavagnetta | mini chalkboard
cm 5x7,5 | pz. conf. 12 | c/c 20



€ 7,85  

S0303 | mini lavagnetta | mini chalkboard
cm 7,5x5 | pz. conf. 12 | c/c 20



non riscrivibili | unrewritable

mix set
5pz



€ 8,23

T5302 | pennarelli da lavagna | *liquid chalks*
cm 1 | pz. conf. 5 | c/c 10

mix set
4pz



€ 5,14

T5301 | pennarelli da lavagna | *liquid chalks*
cm 0,6 | pz. conf. 4 | c/c 10

mix set
4pz



€ 4,62

T5300 | pennarelli da lavagna | *liquid chalks*
cm 0,3 | pz. conf. 4 | c/c 10



€ 4,01

T5258 | lavagna da tavolo | *table chalkboard*
cm 15x23 | pz. conf. 1 | c/c 36



€ 6,07

T5259 | lavagna da tavolo | *table chalkboard*
cm 21x23 | pz. conf. 1 | c/c 24



€ 11,63

T5260 | lavagna da tavolo | *table chalkboard*
cm 29x42 | pz. conf. 1 | c/c 12





€ 1,28  

T5272 | lavagna da tavolo | *table chalkboard*
| cm 7,3x5 | pz. conf. 1 | c/c 100



€ 1,80  

T5268 | lavagna da tavolo | *table chalkboard*
| cm 7,5x5 | pz. conf. 1 | c/c 100



€ 3,20  

T5261 | lavagna con treppiede | *tripod blackboard*
| cm 6,9x10,5 | pz. conf. 1 | c/c 24



€ 3,40  

T5262 | lavagna con treppiede | *tripod blackboard*
| cm 9,7x14,8 | pz. conf. 1 | c/c 24



€ 6,55  

T5264 | lavagna con treppiede | *tripod blackboard*
| cm 21x30 | pz. conf. 1 | c/c 12 





€ 1,48



T5267 | lavagna da tavolo | table chalkboard
| cm 5x7,5 | pz. conf. 1 | c/c 100



€ 1,91



T5271 | lavagna da tavolo | table chalkboard
| cm 7,4x10,5 | pz. conf. 1 | c/c 100



€ 3,40



T5270 | lavagna da tavolo | table chalkboard
| cm 10,5x14,8 | pz. conf. 1 | c/c 100



€ 5,30



T5269 | lavagna da tavolo | table chalkboard
| cm 14,8x21 | pz. conf. 1 | c/c 60



€ 4,14  

T5266 | lavagna portamenu | menu
blackboard | cm 23x32 | pz. conf. 1 | c/c 24



€ 5,75  

T5255 | lavagna rettangolare | rectangular
chalkboard | cm 30x40 | pz. conf. 1 | c/c 12



€ 15,00  

T5256 | lavagna rettangolare | rectangular
chalkboard | cm 40x60 | pz. conf. 1 | c/c 8



€ 84,12



T5253 | lavagna bifacciale | *doublesided*
chalkboard | cm 50x85 | pz. conf. 1 | c/c 1



€ 142,37



T5254 | lavagna bifacciale | *doublesided*
chalkboard | cm 70x120 | pz. conf. 1 | c/c 1



€ 12,42

C0109.A | candeline rosa | *pink candles*
cm Ø 0,6x6,5 | pz. conf. 100 | c/c 25

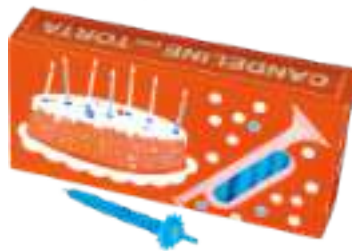

€ 12,42

C0109.F | candeline azzurre | *light blue candles*
cm Ø 0,6x6,5 | pz. conf. 100 | c/c 25



€ 44,00

C0112.Y | candele bianche | *white candles*
cm Ø 2x25 | pz. conf. 50 | c/c 4



€ 44,00

C0112.O | candele avorio | *ivory candles*
cm Ø 2x25 | pz. conf. 50 | c/c 4



€ 3,10

C0261 | accendino ricaricab. | *rechargeable lighter*
cm 27,5 | pz. conf. 1 | c/c 48



€ 10,70

C0013 | lumini scaldavivande | *tealights*
cm Ø 3,5x1,8 | pz. conf. 100 | c/c 8



€ 24,50

C0020.O | candela avorio | *ivory candle*
cm Ø 5x11 | pz. conf. 9 | c/c 8



€ 24,50

C0020.Y | candela bianca | *white candle*
cm Ø 5x11 | pz. conf. 9 | c/c 8



€ 3,95 

C3009.G | portalumino Lilly | tealight holder
Lilly | cm Ø 12x8 | pz. conf. 1 | c/c 48



€ 2,32  

C3003.Z | candeliera nero | black candle
holder | cm 16x5x3 | pz. conf. 2 | c/c 12



€ 2,32  

C3003 | candeliera bamboo | bamboo
candle holder | cm 16x5x3 | pz. conf. 2 |
c/c 12



€ 2,10 

C3006 | portalumino Nautilus | tealight
holder Nautilus | cm 12x10x7 | pz. conf. 1 |
c/c 72





€ 8,12  **SS**

P4000 | set beccucci punta stella | *star hole tips* | cm Ø 2,5x4 | pz. conf. 6 | c/c 10



€ 5,37 **PE**

T4005 | tasca pasticciere | *pastry bag* | cm 30x16 | pz. conf. 100 | c/c 10



€ 8,12  **SS**

P4001 | set beccucci punta tonda | *round hole tips* | cm Ø 2,5x4 | pz. conf. 6 | c/c 10



€ 9,57 **PE**

T4006 | tasca pasticciere | *pastry bag* | cm 46x23 | pz. conf. 100 | c/c 10



€ 8,12  **SS**

P4002 | set beccucci punte varie | *assorted hole tips* | cm Ø 2,5x4 | pz. conf. 6 | c/c 10



€ 12,88 **PE**

T4007 | tasca pasticciere | *pastry bag* | cm 55x27 | pz. conf. 100 | c/c 10



€ 1,75  **SS**

P4006 | spatola dritta | *straight spatula* | cm 20 | pz. conf. 1 | c/c 10



€ 2,25  **SS**

P4003 | spatola a gomito | *angled spatula* | cm 30 | pz. conf. 1 | c/c 10



€ 2,10  **SS**

P4005 | spatola dritta | *straight spatula* | cm 30 | pz. conf. 1 | c/c 10





€ 2,10  **SS**

P4004 | spatola a gomito | *angled spatula* | cm 20 | pz. conf. 1 | c/c 10







€ 5,84  

S0030.Z | piattino quadrato nero | *black square plate* | cm 6x6 | pz. conf. 12 | c/c 100  





€ 5,84  

S0030 | piattino quadrato | *square plate* | cm 6x6 | pz. conf. 12 | c/c 100  





€ 5,84  

S0031.Z | piattino tondo nero | *black round plate* | cm Ø 6 | pz. conf. 12 | c/c 100  





€ 5,84  

S0031 | piattino tondo | *round plate* | cm Ø 6 | pz. conf. 12 | c/c 100  





€ 5,84  

S0034.Z | conchiglia sushi nera | *sushi black shell plate* | cm 10x3,8 | pz. conf. 12 | c/c 100  





€ 5,84  

S0034 | conchiglia sushi | *sushi shell plate* | cm 10x3,8 | pz. conf. 12 | c/c 100  





€ 3,94  

S0032.Z | forchettina nera | *black little fork* | cm 9 | pz. conf. 12 | c/c 100  





€ 3,94  

S0032 | forchettina | *little fork* | cm 9 | pz. conf. 12 | c/c 100  



€ 3,94  

S0033.Z | cucchiaino nero | *black spoon* | cm 9 | pz. conf. 12 | c/c 100  



€ 3,94  

S0033 | cucchiaino | *spoon* | cm 9 | pz. conf. 12 | c/c 100  





€ 4,64

S0037.P | bacchette sushi
| *sushi chopsticks* | cm 21
pz. conf. 100 | c/c 10



€ 5,46

S0037.T | bacchette sushi
| *sushi chopsticks* | cm 21
pz. conf. 100 | c/c 10



€ 4,64

S0037.Z | bacchette sushi
| *sushi chopsticks* | cm 21
pz. conf. 100 | c/c 10



€ 4,64

S0037 | bacchette sushi
| *sushi chopsticks* | cm 21
pz. conf. 100 | c/c 10



€ 4,95

S0035.F | forchetta in bamboo
bamboo fork | cm 14 | pz. conf. 12
c/c 36



€ 4,95

S0035.K | coltello in bamboo
bamboo knife | cm 14 | pz. conf. 12
c/c 36



€ 4,95

S0035.S | cucchiaio in bamboo
bamboo spoon | cm 14 | pz. conf. 12
c/c 36



€ 1,03

S0038.T | spatola in
bamboo | *bamboo spatula*
cm 30 | pz. conf. 1 | c/c 60



€ 1,03

S0038.F | forchetta in
bamboo | *bamboo fork*
cm 30 | pz. conf. 1 | c/c 60



€ 9,13

S0106 | portastuzzicadenti
Chili | *toothpicks holder*
Chili | cm Ø 3,5x4,5 |
pz. conf. 6 | c/c 12



€ 7,85

S0107 | portastuzzicadenti
Qube | *toothpicks holder*
Qube | cm 3,5x3,5x4,5 |
pz. conf. 6 | c/c 12



Barchette in legno | wood small boat



cm 7x5x2

€ 2,96



S0052.S | pz. conf. 50 | c/c 40



cm 9,5x5x1,5



S0041 | pz. conf. 100 | c/c 12
S0041.S | pz. conf. 50 | c/c 40

€ 9,21

€ 3,22



cm 12x7x2



S0042 | pz. conf. 100 | c/c 12
S0042.S | pz. conf. 50 | c/c 40

€ 11,12

€ 3,32



cm 15x7,5x2



S0050.S | pz. conf. 50 | c/c 40

€ 5,51



cm 17,5x8,5x2



S0043 | pz. conf. 100 | c/c 12
S0043.S | pz. conf. 50 | c/c 40

€ 13,34

€ 5,22



cm 22,5x8,5x2



S0049.S | pz. conf. 50 | c/c 40

€ 8,89



cm 15x10x2,5



S0053.S | pz. conf. 50 | c/c 20

€ 12,54



cm 28x12x2,5



S0054.S | pz. conf. 50 | c/c 20

€ 14,41



coni e vaschette | cone and basket



cm Ø 5x2

S0044 | pz. conf. 100 | c/c 12 € 15,14
S0044.S | pz. conf. 50 | c/c 40 € 6,34



cm Ø 4,5x12,5

S0047 | pz. conf. 50 | c/c 12 € 6,14
S0047.S | pz. conf. 50 | c/c 40 € 3,57



cm Ø 4,5x4,3

S0045 | pz. conf. 100 | c/c 12 € 18,00
S0045.S | pz. conf. 50 | c/c 40 € 6,99



cm Ø 5,5x15,5

S0046 | pz. conf. 50 | c/c 12 € 8,21
S0046.S | pz. conf. 50 | c/c 40 € 4,44



cm Ø 7x19,5

S0048 | pz. conf. 50 | c/c 12 € 10,06
S0048.S | pz. conf. 50 | c/c 40 € 5,13



cm 33x6x8

S0075.Z | pz. conf. 2 | c/c 12 € 11,80



cm Ø 9,5x22,5

S0051.S | pz. conf. 50 | c/c 20 € 9,03





€ 24,30  

BIO923 | cannuce colorate | *colored straws*
| cm Ø 0,7x75 | pz. conf. 250 | c/c 12



€ 10,00  

BIO913 | cannuccia imbustata | *wrapped straw*
| cm Ø 0,5x24 | pz. conf. 400 | c/c 16



€ 11,80  

BIO922.Y | cannuccia bianca | *white straw*
| cm Ø 0,7x21 | pz. conf. 500 | c/c 20



€ 11,80  

BIO922.Z | cannuccia nera | *black straw*
| cm Ø 0,7x21 | pz. conf. 500 | c/c 20



€ 10,90  

BIO921.Z | cannuccia PLA nera | *PLA black straw*
| cm Ø 0,7x16 | pz. conf. 500 | c/c 20



€ 9,30  

BIO920.Y | cannuccia bianca | *white straw*
| cm Ø 0,7x14,5 | pz. conf. 500 | c/c 20



€ 9,30  

BIO920.Z | cannuccia nera | *black straw*
| cm Ø 0,7x14,5 | pz. conf. 500 | c/c 20



€ 6,18  

B961 | cannuccia acciaio | *stainless steel straw*
| cm Ø 0,7x14,5 | pz. conf. 6 | c/c 15





Pa  € 7,90

B943 | cannuccia verde | *green straw*
cm Ø 0,6x21 | pz. conf. 250 | c/c 12



Pa  € 8,06

B949 | cannuccia nera | *black straw*
cm Ø 0,7x21 | pz. conf. 250 | c/c 12



Pa  € 7,14

B948 | cannuccia nera | *black straw*
cm Ø 0,7x14,5 | pz. conf. 250 | c/c 12



Pa  € 11,78

B950 | cannuccia imbustata | *wrapped straw*
cm Ø 0,7x21 | pz. conf. 250 | c/c 12



Pa  € 8,06

B946 | cannuccia kraft | *brown straw*
cm Ø 0,7x21 | pz. conf. 250 | c/c 12



Pa  € 6,12

B947 | cannuccia kraft | *brown straw*
cm Ø 0,7x14,5 | pz. conf. 250 | c/c 12



Pa  € 7,90

B941 | cannuccia colorata | *mix color straw*
cm Ø 0,6x21 | pz. conf. 250 | c/c 24



Pa  € 8,67

B940 | cannuccia imbustata | *wrapped straw*
cm Ø 0,6x21 | pz. conf. 250 | c/c 24



Pa  € 7,65

B951 | cannuccia bianca | *white straw*
cm Ø 0,7x21 | pz. conf. 250 | c/c 12



Pa  € 10,60

B952 | cannuccia imbustata | *wrapped straw*
cm Ø 0,7x21 | pz. conf. 250 | c/c 12





Spiedi Deco | sticks Deco |

S0008 | cm 7 | pz. conf. 100 | c/c 50

S0011.2 | cm 10,5 | pz. conf. 100 | c/c 50

S0012.2 | cm 15 | pz. conf. 100 | c/c 50

€ 2,60

€ 2,88

€ 3,17



Spiedi Deco nero | black sticks Deco |

S0011.Z | cm 10,5 | pz. conf. 100 | c/c 50

S0012.Z | cm 15 | pz. conf. 100 | c/c 50

€ 3,66

€ 3,71



S0015 | spiedi Ricciolo | sticks Ricciolo

cm 12 | pz. conf. 100 | c/c 50

S0015.Z | spiedi Ricciolo nero

| black Ricciolo sticks | cm 12 | pz. conf. 100 | c/c 50

€ 4,44

€ 5,06



S0029.Z | spiedi Cuorenero | sticks Cuorenero

cm 15 | pz. conf. 100 | c/c 50

€ 5,73





spade in bamboo | *bamboo paddles*
 cm 25 | pz. conf. 100 | c/c 50
S0014 | in scatola | *in box* | € 3,44
S0014S | in sacchetto | *in bag* | € 2,39



spade in bamboo | *bamboo paddles*
 cm 20 | pz. conf. 100 | c/c 50
S0017 | in scatola | *in box* | € 2,80
S0017S | in sacchetto | *in bag* | € 1,86



spade in bamboo | *bamboo paddles*
 cm 15 | pz. conf. 100 | c/c 50
S0007.2 | in scatola | *in box* | € 2,42
S0007S | in sacchetto | *in bag* | € 1,62



spade in bamboo | *bamboo paddles*
 cm 12 | pz. conf. 100 | c/c 50
S0024 | in scatola | *in box* | € 1,91



spade in bamboo | *bamboo paddles*
 cm 9 | pz. conf. 100 | c/c 50
S0010.2 | in scatola | *in box* | € 1,81
S0010S | in sacchetto | *in bag* | € 1,31



S0002 | spiedi ikebana | *sticks ikebana* | cm 15 | pz. conf. 100 | c/c 50
 € 2,85



€ 4,29



S2001 | spiedi Maori | *sticks Maori* |
cm 12 | pz. conf. 100 | c/c 50



€ 2,24



S0027 | spiedi Osaka | *sticks Osaka* |
cm 9 | pz. conf. 50 | c/c 50



€ 2,86



S0028 | spiedi Akita | *sticks Akita* |
cm 9 | pz. conf. 100 | c/c 50



forchettina lux | *lux small fork* | cm 9
B2 | pz. conf. 1000 | c/c 20 € 11,95
S0019 | pz. conf. 500 | c/c 20 € 7,19
S0021 | pz. conf. 100 | c/c 100 € 1,20



S0039 | fermaboccone Chiba | *double*
stick Chiba | cm 5 | pz. conf. 100 | c/c 50
€ 4,25



S0022 | pinze shushi | *sushi pliers* |
cm 8 | pz. conf. 50 | c/c 50
€ 5,84





spiedi Kyoto | sticks Kyoto |
pz. conf. 50 | c/c 50
S0025 | cm 10 |
S0026 | cm 15 |

€ 3,41
€ 3,61



spiedi Sfera | sticks Sfera | € 3,43
S0009.2 | cm 15 |
pz. conf. 100 | c/c 50



spiedo Kurvi | stick Kurvi | cm 12 | pz.
conf. 100 | c/c 50
S0016 | naturale | natural € 6,04
S0016.M | rosso | red € 6,04
S0016.Z | nero | black € 6,04



S2005 | spiedi Mustache | sticks
Mustache | cm 12 | pz. conf. 100 | c/c 50

€ 6,15



S0018 | spiedi Reiko | sticks Reiko |
cm 9 | pz. conf. 100 | c/c 100

€ 3,20



S2003 | spiedi Cactus | sticks Cactus |
cm 12 | pz. conf. 100 | c/c 50

€ 6,15





€ 1,13



SP1 | bastoncino zucchero filato | cotton
candy stick | cm Ø 0,5x40 | pz. conf. 50 | c/c 50



Spiedi in bamboo | *bamboo sticks*

SP25 | cm Ø 0,25x15 | pz. conf. 1000 | c/c 10

€ 5,18

SP35 | cm Ø 0,25x20 | pz. conf. 1000 | c/c 10

€ 6,14

SP45 | cm Ø 0,3x20 | pz. conf. 1000 | c/c 10

€ 7,94

SP5 | cm Ø 0,33x25 | pz. conf. 1000 | c/c 10

€ 11,64

SP55 | cm Ø 0,3x25 | pz. conf. 1000 | c/c 10

€ 9,68



€ 17,31



S0077.Z | supporto spiedini nero | *black skewer holder*
| cm 24x10x2 18 fori | pz. conf. 3 | c/c 24



€ 16,81



S0077 | supporto spiedini | *skewer holder*
| cm 24x10x2 18 fori | pz. conf. 3 | c/c 24



€ 4,22 Pa 

H1611 | carta per vaporiera | steamer cooking paper | cm Ø 11 | pz. conf. 250 | c/c 8



€ 4,42 W 

S0109.R | base per vaporiera | steamer bamboo base | cm Ø 13 | pz. conf. 1 | c/c 36



€ 13,80 W 

S0110 | vaporiera in bamboo | bamboo steamer | cm Ø 20 | pz. conf. 1 | c/c 12



€ 6,99 W 

S0110.R | base per vaporiera | steamer bamboo base | cm Ø 20 | pz. conf. 1 | c/c 36



€ 9,55 W 

S0109 | vaporiera in bamboo | bamboo steamer | cm Ø 13 | pz. conf. 1 | c/c 24





€ 1,59 **W**

SK1 | stuzzicadenti sfusi 1 punta | 1 point toothpicks | cm 7 | pz. conf. 1000 | c/c 50



€ 0,41 **W**

L102 | stuzzicadenti | box toothpicks | cm 7 | pz. conf. 200 | c/c 288



€ 1,08 **W Pa**

L103 | stuzzicadenti imb. | wrap. toothpicks | cm 7 | pz. conf. 200 | c/c 144



€ 1,13 **W**

L101 | stuzzicadenti barattolo | jar toothpicks | cm 7 | pz. conf. 500 | c/c 150



€ 7,30 **W PE**

S0006 | stuzzicadenti frills | toothpicks frills | cm 11 | pz. conf. 1000 | c/c 10



€ 6,10 **W PE**

S0005 | stuzzicadenti frills | toothpicks frills | cm 7 | pz. conf. 1000 | c/c 10



betulla | birch

€ 3,59 **W Pa**

L1 | stuzzicadenti imb. | wrap. toothpicks | cm 7 | pz. conf. 1000 | c/c 20



bamboo

€ 4,85 **W Pa**

L2 | stuzzicadenti imb. | wrap. toothpicks | cm 7 | pz. conf. 1000 | c/c 20



W PE

€ 12,00

W PE

€ 12,00

W PE

€ 6,73

W Pa

€ 6,36

B36.1 | palma Fiesta lux |
Fiesta lux palm | cm 15 | pz.
conf. 100 | c/c 10

B36L.1 | palma Fiesta lux |
Fiesta lux palm | cm 20 |
pz. conf. 100 | c/c 10

B36S | palma Fiesta | Fiesta
palm | cm 15 | pz. conf. 144
| c/c 10

B15 | ombrellino cocktail |
cocktail umbrella |
cm Ø 8x8,5 | pz. conf. 144 |
c/c 10



Pa !

€ 8,75

W Pa

€ 21,50

€ 3,24

W Pa

€ 8,50

B18 | tucano in carta |
toucan paper decoration |
cm 18 | pz. conf. 100 | c/c 10

B051 | dalia | dalia |
cm Ø 9x24 | pz. conf. 100 |
c/c 10

SB1M.2 | bandierine miste
| mixed flags sticks | cm 7 |
pz. conf. 250 | c/c 40

B206.N | spiedino frutta |
fruit stick | cm 20 |
pz. conf. 100 | c/c 10





€ 4,42  

Q1019 | marcatore in legno | wooden marker
| cm 8 | pz. conf. 250 | c/c 10



ben cotta | well

€ 5,35  

Q1022 | marcatore "ben cotto" | steak marker
"well" | cm 9 | pz. conf. 250 | c/c 20



€ 2,96  

Q1027 | forchettina pesce | fish small fork |
cm 9,5 | pz. conf. 250 | c/c 40



media | medium

€ 5,35  

Q1021 | marcatore "medio" | steak marker
"medium" | cm 9 | pz. conf. 250 | c/c 20



€ 7,72  

S0020 | forchettina legno | wooden small
fork | cm 9 | pz. conf. 1000 | c/c 20



al sangue | rare

€ 5,35  

Q1020 | marcatore "al sangue" | steak marker
"rare" | cm 9 | pz. conf. 250 | c/c 20





€ 1,95 **W**

Q1016 | cucchiaino da gelato | ice cream spoon | cm 9,5x1,7x0,15 | pz. conf. 48 | c/c 24



€ 10,30 **W**

Q1028 | miscelatore | cocktail stirrer | cm 15xØ2,8 | pz. conf. 250 | c/c 10



€ 2,30 **W**

Q1017 | cucchiaino in legno | wooden teaspoon | cm 10x2,8x0,15 | pz. conf. 48 | c/c 24



€ 5,82 **W Pa**

Q1023 | paletta imbustata | wrapped coffee stirrer | cm 9x0,6x0,13 | pz. conf. 500 | c/c 20



€ 2,30 **W**

Q1018 | forchettina in legno | wooden fork | cm 10,5x2,5x0,12 | pz. conf. 48 | c/c 24



€ 6,35 **W Pa**

Q1025 | paletta imbustata | wrapped coffee stirrer | cm 11x0,6x0,13 | pz. conf. 500 | c/c 20





€ 3,49 **W Pa**

Q1031 | coltello imbustato | *wrapped knife*
| cm 16 | pz. conf. 48 | c/c 10



€ 9,91 **W**

Q1001 | piatto ovale | *oval plate* | cm
21x14x2 | pz. conf. 24 | c/c 12



€ 6,00 **W Pa**

Q1032 | forchetta imbustata | *wrapped fork*
| cm 16 | pz. conf. 48 | c/c 10



€ 8,60 **W**

Q1007 | vassoio rettangolare | *rectangular tray*
| cm 21x10,5x3 | pz. conf. 24 | c/c 12



€ 6,85 **W Pa**

Q1033 | cucchiaino imbustato | *wrapped spoon*
| cm 16 | pz. conf. 48 | c/c 10



€ 8,50 **W Pa**

Q1015 | bis posate in legno | *wood cutlery set*
| cm 16 | pz. conf. 48 | c/c 10



€ 11,10 **W Pa**

Q1030 | tris posate in legno | *wooden cutlery set*
| cm 16 | pz. conf. 48 | c/c 10





€ 4,03  

S0059 | mini tagliere rettangolare | *mini rect. cutting board* | cm 6x10 | pz. conf. 24 | c/c 24



€ 4,03  

S0058 | mini tagliere rotondo | *mini round cutting board* | cm Ø 8 | pz. conf. 24 | c/c 24



€ 2,50  

Q1012 | cucchiaio in legno | *wooden spoon* | cm 16 | pz. conf. 48 | c/c 24



€ 1,55  

Q1014 | cucchiaino in legno | *wooden teaspoon* | cm 9,5 | pz. conf. 48 | c/c 24



€ 2,40  

Q1013 | forchetta in legno | *wooden fork* | cm 16 | pz. conf. 48 | c/c 24



€ 1,90  

Q1011 | coltello in legno | *wooden knife* | cm 16 | pz. conf. 48 | c/c 24





€ 4,34 WP

Q6006 | piatto rotondo | *round plate*
cm Ø 17 | pz. conf. 12 | c/c 24



€ 3,04 WP

Q6011 | ciotola | *bowl* | cm Ø 6 | pz. conf. 12
| c/c 12



€ 6,96 WP

Q6005 | piatto rotondo | *round plate*
cm Ø 23 | pz. conf. 12 | c/c 12



€ 3,50 WP

Q6010 | ciotola | *bowl* | cm Ø 9 | pz. conf. 12
| c/c 12



€ 7,77 WP

Q6004 | piatto rotondo | *round plate*
cm Ø 26 | pz. conf. 12 | c/c 12



€ 7,33 WP

Q6009 | ciotola | *bowl* | cm Ø 15 | pz. conf. 12
| c/c 12



€ 5,77 WP

Q6013 | piatto ovale | *oval plate* | cm 19x13 |
pz. conf. 12 | c/c 12



€ 5,14 WP

Q6008 | vassoio rettangolare | *rectangular*
tray | cm 16x13,5 | pz. conf. 12 | c/c 12



€ 10,14 WP

Q6012 | piatto ovale | *oval plate* | cm
28,5x20 | pz. conf. 12 | c/c 12



€ 5,83 WP

Q6007 | vassoio rettangolare | *rectangular*
tray | cm 24,5x15,5 | pz. conf. 12 | c/c 12



Può contenere cibi liquidi e solidi, sia caldi che freddi. Può essere utilizzato nel forno tradizionale o a microonde per pochi minuti fino a 200°C. Resiste a temperature sotto lo zero, in frigorifero e nel congelatore.

It can be used with liquid and solid foods, both hot and cold. It can be used in a traditional or microwave oven for a few minutes up to 200°C. It can withstand sub-zero temperatures in the refrigerator and freezer.



€ 3,91  

Q6002 | piatto quadrato | square plate
cm 15x15 | pz. conf. 12 | c/c 24



€ 2,87  

Q6003 | piatto quadrato | square plate
cm 10x10 | pz. conf. 12 | c/c 12



€ 7,77  

Q6000 | piatto quadrato | square plate
cm 25,5x25,5 | pz. conf. 12 | c/c 12



€ 5,44  

Q6001 | piatto quadrato | square plate
cm 20x20 | pz. conf. 12 | c/c 12



€ 4,75



Q2020 | ciotola | bowl | cm Ø 16x4 - 350 ml | pz. conf. 50 | c/c 20



€ 12,80



Q2089 | coperchio | lid | cm 16,3x16,3x4 | pz. conf. 50 | c/c 8



€ 7,65



Q2021 | piatto fondo | soup plate | cm Ø 19x4 - 680 ml | pz. conf. 50 | c/c 10



€ 5,85



Q2088 | piatto quadrato | square plate | cm 16x16 | pz. conf. 50 | c/c 8



€ 3,34



Q2010 | piatto tondo | round plate | cm Ø 16 | pz. conf. 50 | c/c 20



€ 5,05



Q2017 | piatto quadrato | square plate | cm 16x16 | pz. conf. 50 | c/c 10



€ 4,27



Q2011 | piatto tondo | round plate | cm Ø 18 | pz. conf. 50 | c/c 20



€ 9,30



Q2018 | piatto quadrato | square plate | cm 20x20 | pz. conf. 50 | c/c 10



€ 6,35



Q2012 | piatto tondo | round plate | cm Ø 22,5 | pz. conf. 50 | c/c 10



€ 16,69



Q2025 | piatto quadrato | square plate | cm 26x26 | pz. conf. 50 | c/c 10



€ 9,63



Q2013 | piatto tondo | round plate | cm Ø 26 | pz. conf. 50 | c/c 10



€ 8,75



Q2019 | piatto rettangolare | rectangular plate | cm 25x13 | pz. conf. 50 | c/c 10





€ 5,25



Q2065 | piatto fondo quadrato | *soup square plate* | cm 15x4 | pz. conf. 50 | c/c 10



€ 10,40



Q2016 | piatto 3 scomparti | *3 compartments plate* | cm Ø 26 | pz. conf. 50 | c/c 10



€ 6,95



Q2014 | piatto ovale | *oval plate* | cm 26x19 | pz. conf. 50 | c/c 10



€ 14,42



Q2087 | coperchio ovale | *oval lid* | cm 32x25x5 | pz. conf. 25 | c/c 4



€ 12,82



Q2015 | piatto ovale | *oval plate* | cm 32x25 | pz. conf. 50 | c/c 10



€ 18,18



Q2072 | piatto pizza | *pizza plate* | cm Ø 34 | pz. conf. 25 | c/c 6





€ 13,53



Q2111 | sandwich box | *sandwich box*
cm 18x12x7 - 1300 ml | pz. conf. 50 | c/c 8



€ 9,00



Q2022 | hamburger box | *hamburger box*
cm 15x15x8,5 - 800 ml | pz. conf. 50 | c/c 10



€ 12,60



Q2023 | sandwich box | *sandwich box*
cm 23x15x8 - 1400 ml | pz. conf. 50 | c/c 6



€ 12,02



Q2112 | hamburger box | *hamburger box*
cm 19x20,5x10 - 3500 ml | pz. conf. 25 | c/c 8



€ 12,84



Q2113 | hamburger box | *hamburger box*
cm 23x22x9,5 - 4300 ml | pz. conf. 25 | c/c 8





€ 6,80



Q2117 | vassoio sushi | *sushi tray*
cm 22x9,2x2 | pz. conf. 50 | c/c 10



€ 10,20



Q2121 | coperchio | *lid*
cm 22,4x9,55x3,2 | pz. conf. 50 | c/c 10



€ 10,20



Q2118 | vassoio sushi | *sushi tray*
cm 18,4x12,8x2 | pz. conf. 50 | c/c 8



€ 11,65



Q2122 | coperchio | *lid*
cm 18,8x13x3,2 | pz. conf. 50 | c/c 8



€ 11,00



Q2119 | vassoio sushi | *sushi tray*
cm 21,5x13,5x2 | pz. conf. 50 | c/c 8



€ 14,05



Q2123 | coperchio | *lid*
cm 22x14x3,2 | pz. conf. 50 | c/c 8



€ 11,85



Q2120 | vassoio sushi | *sushi tray*
cm 23,7x14,5x2 | pz. conf. 50 | c/c 6



€ 16,10





Q2124 | coperchio | *lid*
cm 24x15x3,2 | pz. conf. 50 | c/c 6







€ 6,35  

Q2125 | ciotola tonda | *round bowl*
cm Ø 15,5x5,4 - 500 ml | pz. conf. 50 | c/c 20  





€ 9,75  

Q2061 | ciotola tonda | *round bowl*
cm Ø 17,2x6,3 - 800 ml | pz. conf. 50 | c/c 10  



€ 17,54  

Q2060 | ciotola tonda | *round bowl*
cm Ø 19,5x7,5 - 900 ml | pz. conf. 50 | c/c 8  



€ 14,55  

Q2078 | coperchio in pet | *pet lid*
cm Ø 18 | pz. conf. 50 | c/c 8 





€ 13,45  

Q2069 | piatto fondo | *soup plate*
cm Ø 19,5x5 - 500 ml | pz. conf. 50 | c/c 8  





€ 8,32  

Q2062 | ciotola tonda | *round bowl*
cm Ø 15,5x5,4 - 500 ml | pz. conf. 50 | c/c 20  



€ 13,15  

Q2077 | ciotola | *bowl* | cm Ø 17,5x6,7 - 950 ml | pz. conf. 50 | c/c 8  



€ 12,80  

Q2116 | coperchio tondo | *round lid*
cm Ø 17x3,5 | pz. conf. 50 | c/c 8 



€ 21,13  

Q2060.C | coperchio in RPET | *RPET lid*
cm Ø 19,5 | pz. conf. 50 | c/c 8 





€ 8,90  

Q2070 | piatto ovale | *oval plate*
cm 20,5x14,5x4 - 500 ml | pz. conf. 50 | c/c 5



€ 6,15  

Q2063 | ciotola tonda | *round bowl*
cm Ø 13,5x4,6 - 350 ml | pz. conf. 50 | c/c 20



€ 10,80  

Q2081 | ciotola ovale | *oval bowl*
cm 20,3x13,5x4 - 550 ml | pz. conf. 50 | c/c 6



€ 13,49  

Q2082 | coperchio ovale | *oval lid*
cm 21x14x3,5 | pz. conf. 50 | c/c 6



€ 18,45  

Q2079 | ciotola ovale | *oval bowl*
cm 23,6x17x4 - 750 ml | pz. conf. 50 | c/c 6



€ 16,55  

Q2080 | coperchio ovale | *pet oval lid*
cm 24x17x3,5 | pz. conf. 50 | c/c 4



€ 14,85  

Q2071 | piatto ovale | *oval plate*
cm 26x20x4,5 - 900 ml | pz. conf. 50 | c/c 5



€ 21,40  

Q2086 | coperchio ovale | *oval lid*
cm 26,9x20,4x4,9 | pz. conf. 50 | c/c 4





€ 8,94



Q2103 | coperchio ovale | cellulose lid
cm 24,5x14x1 | pz. conf. 50 | c/c 6



€ 7,25



Q2110 | coperchio rettangolare | rectangular lid
cm 23,5x18,5x2,5 | pz. conf. 40 | c/c 6



€ 8,95



Q2101 | vaschetta ovale | oval bowl
cm 23,5x13,1x7 - 1000 ml | pz. conf. 50 | c/c 6



€ 6,55



Q2107 | vaschetta rettangolare | rectangular tray
cm 22x17x3,5 - 850 ml | pz. conf. 40 | c/c 6



€ 7,90



Q2099 | vaschetta ovale | oval bowl
cm 23,5x13x4 - 850 ml | pz. conf. 50 | c/c 6



€ 8,25



Q2108 | vaschetta rettangolare | rectangular tray
cm 22x17x5 - 1100 ml | pz. conf. 40 | c/c 6



€ 7,30



Q2102 | vaschetta 2 scomparti | 2 compartment tray
cm 23,5x13x7 - 1000 ml | pz. conf. 50 | c/c 6



€ 10,00



Q2109 | vaschetta rettangolare | rectangular tray
cm 22x17x7 - 1300 ml | pz. conf. 40 | c/c 6



€ 7,95



Q2100 | vaschetta 2 scomparti | 2 compartment tray
cm 23,5x13x4 - 850 ml | pz. conf. 50 | c/c 6



€ 13,25



Q2083 | ciotola rettangolare | rectangular bowl
cm 23x18x4,3 - 1100 ml | pz. conf. 50 | c/c 4



€ 20,05



Q2085 | coperchio | lid
cm 23,5x18,5x1,5 | pz. conf. 50 | c/c 4



€ 19,30



Q2084 | ciotola rettangolare | rectangular bowl
cm 23x18x7,7 - 1800 ml | pz. conf. 50 | c/c 4







€ 7,60



Q2092 | coperchio | lid
cm 26,3x13,5x1,5 | pz. conf. 40 | c/c 6



€ 9,10



Q2091 | vaschetta 3 scomparti | 3 compartment tray | cm 25,8x13x6 | pz. conf. 40 | c/c 6



€ 4,90



Q2106 | coperchio | lid
cm 18,5x12,5x1,5 | pz. conf. 50 | c/c 6



€ 8,35



Q2104 | vaschetta rettangolare | rectangular tray | cm 18x12x5 - 650 ml | pz. conf. 50 | c/c 6



€ 11,15



Q2105 | vaschetta rettangolare | rectangular tray | cm 18x12x7 - 950 ml | pz. conf. 50 | c/c 6





€ 6,65



Q2024 | vaschetta chips | *chips tray*
cm 17x12x4 -500 ml | pz. conf. 50 | c/c 10



€ 5,75



Q2068 | vassoio rettangolare | *rectangular tray*
cm 18,5x13,5x2,3 | pz. conf. 50 | c/c 20



€ 8,35



Q2067 | vassoio rettangolare | *rectangular tray*
cm 22,5x13,5x2,3 | pz. conf. 50 | c/c 10



€ 22,75



Q2066.C | coperchio in RPET | *RPET lid*
cm 23,7x16,3x2,7 | pz. conf. 50 | c/c 10



€ 14,70



Q2066 | vaschetta rettangolare | *rectangular deep tray*
cm 23x15,5x4,5 - 800 ml | pz.





€ 7,05



Q2093 | vassoio 3 scomparti | 3 compartment tray | cm 22,5x17,5x4 | pz. conf. 25 | c/c 8



€ 6,49



Q2094 | coperchio | lid | cm 23x18x1,5 | pz. conf. 25 | c/c 8



€ 15,47



Q2095 | vassoio 3 scomparti | 3 compartment tray | cm 24x22x4 | pz. conf. 25 | c/c 4



€ 7,89



Q2096 | coperchio | lid | cm 24,5x22,5x1,5 | pz. conf. 25 | c/c 4



€ 23,10



Q2075 | ciotola quadrata | square bowl | cm 18x18x9 - 1200 ml | pz. conf. 50 | c/c 6



€ 16,65



Q2076 | coperchio quadrato in PET | PET square lid | cm 18,5x18,5 | pz. conf. 50 | c/c 4



€ 16,85



Q2074 | ciotola quadrata | square bowl | cm 18x18x7,5 - 950 ml | pz. conf. 50 | c/c 6



€ 16,25



Q2073 | ciotola quadrata | square bowl | cm 18x18x6 - 700 ml | pz. conf. 50 | c/c 6



€ 6,15



Q2090 | vaschetta con salsiera | tray with sauce holder | cm 21,8x16,5x4,5 | pz. conf. 25 | c/c 8



€ 22,75



Q2066.C | coperchio in RPET | RPET lid | cm 23,7x16,3 | pz. conf. 50 | c/c 20







€ 11,82



Q2034 | cucchiaino finger food | *finger food spoon* | cm 5x10 | pz. conf. 100 | c/c 10



€ 5,73



Q2003 | cucchiaino finger food | *finger food spoon* | cm 12,4x2,7x0,6/2,7 | pz. conf. 50 | c/c 20



€ 5,73



Q2002 | piattino finger food | *finger food plate* | cm 11x5,2x3 | pz. conf. 50 | c/c 20



€ 5,73



Q2000 | foglia finger food | *finger food leaf* | cm Ø9x6x1,2 | pz. conf. 50 | c/c 20



€ 9,32



Q2036 | ciotolina finger food | *finger food cup* | cm Ø 7,2x3 | pz. conf. 50 | c/c 10



€ 7,06



Q2035 | piattino finger food | *finger food plate* | cm 6,5x6,5x1 | pz. conf. 50 | c/c 10



€ 5,73



Q2001 | piattino finger food | *finger food plate* | cm 8x4,8x1,2/2,7 | pz. conf. 50 | c/c 20



€ 7,06



Q2037 | piattino finger food | *finger food plate* | cm Ø 7,2x1 | pz. conf. 50 | c/c 10



€ 5,02



Q2006 | vassoietto finger food | *finger food shape* | cm 13x11,6x1,2 | pz. conf. 50 | c/c 20



€ 5,56





Q2007 | vassoietto finger food | *finger food tray* | cm 10x10x2 | pz. conf. 50 | c/c 20

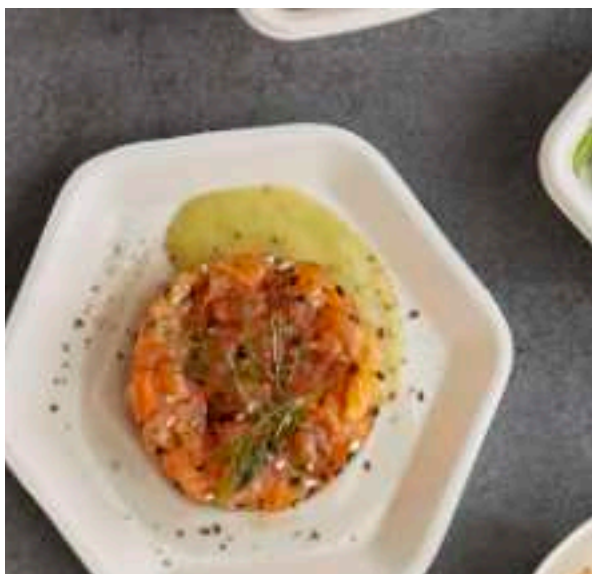







€ 4,14  

Q2004 | ciotolina finger food polpa | *finger food bowl* | cm Ø4xØ6x3 | pz. conf. 50 | c/c 20  





€ 7,45  

Q2064 | ciotola con coperchio | *mini bowl with lid* | cm Ø 6,8x3 - 59 ml | pz. conf. 50 | c/c 10  





€ 5,56  

Q2005 | vassoietto finger food | *finger food tray* | cm 14x8,1x2,2 | pz. conf. 50 | c/c 20  





€ 8,78  

Q2009 | ciotolina finger food polpa | *finger food bowl* | cm 8x8x4,5 | pz. conf. 50 | c/c 20  



€ 7,27  

Q2008 | ciotolina finger food polpa | *finger food bowl* | cm 8x8x3 | pz. conf. 50 | c/c 20  





€ 5,63



Q2031 | bicchierino | *small cup*
cm Ø 7,5x5 - 150 ml | pz. conf. 50 | c/c 20



€ 6,62



Q2030 | bicchiere | *cup*
cm Ø 8x9 - 240 ml | pz. conf. 50 | c/c 20



€ 3,65



Q2059 | cucchiaio in polpa | *cellulose pulp spoon*
cm 16 | pz. conf. 50 | c/c 20



€ 3,65



Q2058 | forchetta in polpa | *cellulose pulp fork*
cm 16 | pz. conf. 50 | c/c 20



€ 3,65



Q2057 | coltello in polpa | *cellulose pulp knife*
cm 16 | pz. conf. 50 | c/c 20





€ 8,64 Pa 

Q5000.K | piatto tondo | *round plate*
cm Ø 18 | pz. conf. 100 | c/c 10



€ 8,54 Pa 

Q5030.K | ciotola tonda | *round bowl*
cm Ø 19 | pz. conf. 50 | c/c 12



€ 12,30 Pa 

Q5001.K | piatto tondo | *round plate*
cm Ø 23 | pz. conf. 100 | c/c 5



€ 15,65 Pa 

Q5015.K | vassoio rettangolare | *rectangular tray*
cm 13x20 | pz. conf. 250 | c/c 6



€ 10,65 Pa 

Q5100.K | piatto tondo | *round plate*
cm Ø 18 | pz. conf. 100 | c/c 10



€ 12,33 Pa 

Q5130.K | ciotola tonda | *round bowl*
cm Ø 19 | pz. conf. 50 | c/c 12



€ 14,84 Pa 

Q5101.K | piatto tondo | *round plate*
cm Ø 23 | pz. conf. 100 | c/c 5



€ 20,56 Pa 

Q5110 | piatto quadrato | *square plate*
cm 20x20 | pz. conf. 100 | c/c 5



€ 21,22 Pa 

Q5115.K | vassoio rettangolare | *rectangular tray*
cm 13x20 | pz. conf. 250 | c/c 6



€ 16,14 Pa

H0747.V | box fritti vintage | *vintage fries box*
| cm 21x14x10,3 - 3000 ml | pz. conf. 25 | c/c 6



€ 12,64 Pa

H0719 | hamburger box | *hamburger box* |
cm 10,5x10,5x8,5 -950 ml | pz. conf. 50 | c/c 4



€ 10,15 Pa

H0746.V | box fritti vintage | *vintage fries box*
| cm 19x11x7 - 1300 ml | pz. conf. 25 |
c/c 6



€ 14,58 Pa

H0707 | hamburger box | *hamburger box* |
cm 12x12x7 -800 ml | pz. conf. 50 | c/c 4



€ 21,50 Pa

H0712.V | box take away | *take away box*
cm 21x16x9 -2500 ml | pz. conf. 40 | c/c 4



€ 22,36 Pa

H0708.V | hamburger box | *hamburger box* |
cm 16x16x9 -1800 ml | pz. conf. 50 | c/c 4



€ 14,60 Pa

H0711 | box take away | *take away box*
cm 13x9x6,4 - 750 ml | pz. conf. 50 | c/c 9



€ 22,36 Pa

H0708 | hamburger box | *hamburger box* |
cm 16x16x9 -1800 ml | pz. conf. 50 | c/c 4



€ 19,60 Pa

H0727 | box take away | *take away box*
cm 19,5x9x6 - 1200 ml | pz. conf. 50 | c/c 4



€ 21,50 Pa

H0712 | box take away | *take away box* |
cm 21x16x9 -2500 ml | pz. conf. 40 | c/c 4



€ 18,55 Pa 

H0728 | hamburger box | *hamburger box* |
cm 20,5x10,7x7,7 -1500 ml | pz. conf. 50 | c/c 4



€ 19,64 Pa 

H0724 | hamburger box | *hamburger box* |
cm 19x11x7 - 1200 ml | pz. conf. 50 | c/c 4



€ 13,53 Pa 

H0710 | box take away | *take away box* |
cm 9,8x8,5x9,2 - 750 ml | pz. conf. 50 | c/c 10



€ 7,53 Pa 

H0725 | box fritti | *fries box* |
cm Ø 6,4x14,5 - 470 ml | pz. conf. 50 | c/c 10



€ 7,40 Pa 

H0726 | box fritti | *fries box* | cm Ø 6,4x17,6
-620 ml | pz. conf. 50 | c/c 10



€ 7,43 Pa

H0752 | vaschetta fritti | *fries tray* |
cm 13x8,5x3,5 - 200 ml | pz. conf. 125 | c/c 8



€ 26,18 Pa PET

H0713 | sandwich box | *sandwich box* |
cm 12,3x7,2x12,3 | pz. conf. 100 | c/c 5



€ 10,16 Pa

H0753 | vaschetta fritti | *fries tray* |
cm 15x10,5x3,7 - 300 ml | pz. conf. 125 | c/c 8



€ 7,20 Pa

H0751 | vaschetta fritti | *fries tray* |
cm 11,1x7,5x3 - 100 ml | pz. conf. 125 | c/c 8



€ 10,40 Pa

H0754 | vaschetta fritti | *fries tray* |
cm 16,5x13,5x4,3 - 400 ml | pz. conf. 125 | c/c 4



€ 10,70 Pa

H0704 | vaschetta fritti | *fries tray* |
cm 13x9,5x4,8 - 400 ml | pz. conf. 100 | c/c 10



€ 16,08 Pa

H0755 | vaschetta fritti | *fries tray* |
cm 19,5x16,5x5,5 - 700 ml | pz. conf. 125 |
c/c 4



€ 12,75 Pa

H0703 | vaschetta fritti | *fries tray* |
cm 18x12x4 - 500 ml | pz. conf. 100 | c/c 10



€ 18,09 Pa

H0756 | vaschetta fritti | *fries tray* |
cm 23x18,5x5,7 - 1100 ml | pz. conf. 125 | c/c 4



€ 20,08 Pa

H0714 | vaschetta fritti | *fries tray* |
cm 25,6x16,7x4 - 800 ml | pz. conf. 100 | c/c 4



€ 6,90 Pa 

H0701 | cono da fritti | *fries cone* |
cm 7x7x17,5 -200 ml | pz. conf. 50 | c/c 10



€ 8,70 Pa 

H0702 | cono da fritti | *fries cone* |
cm 9,5x9,5x22,5 -500 ml | pz. conf. 50 | c/c 10



€ 6,61 Pa 

H0757 | bicchiere fritti | *fries cup* |
cm 6x6,3x12 -180 ml | pz. conf. 50 | c/c 20



€ 11,95 Pa 

H0705 | box fritti | *fries box* |
cm 10,5x10,5x5,5 -150 ml | pz. conf. 100 | c/c 10



€ 13,40 Pa 

H0706 | box fritti | *fries box* |
cm 13x13x5,5 -250 ml | pz. conf. 100 | c/c 10



€ 6,12 **NEW** **PP**

H0773 | coperchio pp | *pp lid*
cm 17x17 | pz. conf. 24 | c/c 15



€ 3,72 **NEW** **PP**

H0768 | coperchio pp | *pp lid*
cm 17,3x12,3 | pz. conf. 24 | c/c 15



750ml

€ 8,28 **NEW** **Pa**

H0769 | vaschetta insalatiera | *salad bowl*
cm 17x17x4,4 | pz. conf. 24 | c/c 15



500ml

€ 5,84 **NEW** **Pa**

H0765 | vaschetta insalatiera | *salad bowl*
cm 17,3x12,3x4 | pz. conf. 24 | c/c 15



1000ml

€ 8,72 **NEW** **Pa**

H0770 | vaschetta insalatiera | *salad bowl*
cm 17x17x5,6 | pz. conf. 24 | c/c 15



750ml

€ 6,04 **NEW** **Pa**

H0766 | vaschetta insalatiera | *salad bowl*
cm 17,3x12,3x5,7 | pz. conf. 24 | c/c 15



1200ml

€ 9,12 **NEW** **Pa**

H0771 | vaschetta insalatiera | *salad bowl*
cm 17x17x6,6 | pz. conf. 24 | c/c 15



1000ml

€ 6,68 **NEW** **Pa**

H0767 | vaschetta insalatiera | *salad bowl*
cm 17,3x12,3x7,5 | pz. conf. 24 | c/c 15



1400ml

€ 9,56 **NEW** **Pa**

H0772 | vaschetta insalatiera | *salad bowl*
cm 17x17x7,5 | pz. conf. 24 | c/c 15



**vaschette
impilabili
stackable bowls**





€ 5,35 Pa 

H0759.V | insalatiera vintage | *vintage salad bowl* | cm Ø 15x7,5 - 1000 ml | pz. conf. 24 | c/c 15



€ 5,25 Pa 

H0763 | insalatiera | *salad bowl* | cm Ø 15x5 - 500 ml | pz. conf. 24 | c/c 15



€ 5,10 Pa 

H0758 | insalatiera | *salad bowl* | cm Ø 15x6 - 750 ml | pz. conf. 24 | c/c 15



€ 5,35 Pa 

H0759 | insalatiera | *salad bowl* | cm Ø 15x7,5 - 1000 ml | pz. conf. 24 | c/c 15



€ 7,80 Pa 

H0761 | insalatiera | *salad bowl* | cm Ø 18,4x6,8 - 1300 ml | pz. conf. 24 | c/c 15





€ 4,50 Pa 

H0764 | coperchio insalatiera | lid for salad bowl | cm Ø 15 | pz. conf. 12 | c/c 15



€ 5,10 Pa 

H0758.Z | insalatiera | salad bowl | cm Ø 15x6 - 750 ml | pz. conf. 24 | c/c 15



€ 3,50 PET

H0760 | coperchio insalatiera | lid for salad bowl | cm Ø 15 | pz. conf. 24 | c/c 15



€ 5,35 Pa 

H0759.Z | insalatiera | salad bowl | cm Ø 15x7,5 - 1000 ml | pz. conf. 24 | c/c 15



€ 4,85 PET

H0762 | coperchio insalatiera | lid for salad bowl | cm Ø 18,4 | pz. conf. 24 | c/c 15



€ 7,80 Pa 

H0761.Z | insalatiera | salad bowl | cm Ø 18,4x6,8 - 1300 ml | pz. conf. 24 | c/c 15





€ 80,00 Pa 

H0801 | coppette kraft | *kraft paper cup* |
cm Ø 7,5x4,5 -90 ml | pz. conf. 1000 (50x20) |
c/c 4



€ 99,90 Pa 

H0802 | coppette kraft | *kraft paper cup* |
cm Ø 8,5x5 -150 ml | pz. conf. 1000 (50x20) |
c/c 4



€ 104,40 Pa 

H0803 | coppette kraft | *kraft paper cup* |
cm Ø 9,5x5,5 - 240 ml | pz. conf. 1000
(50x20) | c/c 4



€ 81,80 Pa 

H0804 | coppette kraft | *kraft paper cup* |
cm Ø 10,5x6,6 -355 ml | pz. conf. 500 (50x10) |
c/c 4



€ 96,85 Pa 

H0805 | coppette kraft | *kraft paper cup* |
cm Ø 12x8 -580 ml | pz. conf. 500 (50x10) |
c/c 4





€ 9,30 Pa

H0720 | contenitore c/coperchio | *cup with lid*
| cm 9x7,2x8,6 - 350 ml | pz. conf. 25 | c/c 10



€ 10,35 Pa

H0721 | contenitore c/coperchio | *cup with lid*
| cm 9,8x7,5x10 - 470 ml | pz. conf. 25 | c/c 10



€ 12,92 Pa

H0722 | contenitore c/coperchio | *cup with lid*
| cm 11,7x9,2x11 - 740 ml | pz. conf. 25 | c/c 10



€ 15,20 Pa

H0723 | contenitore c/coperchio | *cup with lid*
| cm 11,7x9,2x13,5 - 940 ml | pz. conf. 25 | c/c 10





€ 10,10 Pa PET

H0715 | box con finestra | box with window
| cm 10x10x4 - 400 ml | pz. conf. 25 | c/c 10



€ 12,64 Pa PET

H0716 | box con finestra | box with window
| cm 12x12x4 - 700 ml | pz. conf. 25 | c/c 10



€ 14,14 Pa PET

H0717 | box con finestra | box with window
| cm 14x14x4 - 1000 ml | pz. conf. 25 | c/c 10



€ 17,88 Pa PET

H0718 | box con finestra | box with window
| cm 18x18x4 - 1500 ml | pz. conf. 20 | c/c 10





€ 26,00 Pa 

T2001 | shopper take away | *shopper take away* | cm 27+16x29 | pz. conf. 50 | c/c 5



€ 23,90 Pa 

T2000 | shopper take away | *shopper take away* | cm 22+10x32 | pz. conf. 50 | c/c 5



€ 28,30 Pa 

T2002 | shopper take away | *shopper take away* | cm 32+21x24 | pz. conf. 50 | c/c 4





€ 3,15 Pa PLA

Q4000 | mini vaschetta | mini tray |
cm 5,5x5,5x2,5 | pz. conf. 50 | c/c 8



€ 7,30 Pa PLA

Q4003 | vaschetta | tray |
cm 14x8,5x5,5 | pz. conf. 50 | c/c 8



€ 3,69 Pa PLA

Q4001 | vaschetta | tray |
cm 9x5,5x3,5 | pz. conf. 50 | c/c 8



€ 7,90 Pa PLA

Q4004 | vaschetta | tray |
cm 17x9,5x5,5 | pz. conf. 50 | c/c 8





€ 5,70 Pa PLA

Q4011 | insalatiera | *salad bowl* |
cm Ø 14,8x6 | pz. conf. 24 | c/c 15



€ 7,75 Pa PLA

Q4012 | insalatiera | *salad bowl* |
cm Ø 14,8x7,8 | pz. conf. 24 | c/c 15



€ 10,35 Pa PLA

Q4016 | insalatiera | *salad bowl* |
cm Ø 18,4x7 | pz. conf. 24 | c/c 15



€ 6,30 PLA

Q4013 | coperchio in pla | *pla lid* |
cm Ø 14,8 | pz. conf. 24 | c/c 15



€ 10,90 PLA

Q4017 | coperchio in pla | *pla lid* |
cm Ø 18,4 | pz. conf. 24 | c/c 15





€ 5,90 Pa PLA

Q4006 | bicchiere per fritti | *fries cup* | cm Ø 9x14,8 - 450 ml | pz. conf. 50 | c/c 12 



€ 5,50 Pa PLA

Q4005 | bicchiere per fritti | *fries cup* | cm Ø 7x11,8 - 350 ml | pz. conf. 50 | c/c 12 



€ 6,55 Pa PLA

Q4007 | take away box | *take away box* | cm 11,2x9x6,5 - 800 ml | pz. conf. 25 | c/c 20 



€ 6,60 Pa PLA

Q4018 | hamburger box | *hamburger box* | cm 10,5x10,2x8,5 - 950 ml | pz. conf. 25 | c/c 8 



€ 6,10 Pa PLA

Q4009 | take away box | *take away box* | cm 8,9x6,8x10,2 - 900 ml | pz. conf. 25 | c/c 20 



€ 14,45 Pa PLA

Q4021 | hamburger box | *hamburger box* | cm 17,8x16x8 - 2200 ml | pz. conf. 25 | c/c 8 



€ 8,90 Pa PLA

Q4010 | take away box | *take away box* | cm 15,3x12x6,5 - 1350 ml | pz. conf. 25 | c/c 15 



€ 10,45 Pa PLA

Q4019 | hamburger box | *hamburger box* | cm 17x9x8,4 - 1700 ml | pz. conf. 25 | c/c 8 



€ 14,60 Pa PLA

Q4008 | take away box | *take away box* | cm 19,7x14x4,8 - 1480 ml | pz. conf. 25 | c/c 10 



€ 11,65 Pa PLA

Q4020 | hamburger box | *hamburger box* | cm 20,5x10,7x7,7 - 1800 ml | pz. conf. 25 | c/c 8 





€ 4,60



Q2043.S | cucchiaino in cpla | *cpla tea spoon* | cm 10 | pz. conf. 100 | c/c 20



€ 4,60



Q2043.Z | cucchiaino nero | *black teaspoon* 10cm | pz. conf. 100 | c/c 20



€ 3,50



Q2044.S | cucchiaio bianco | *white spoon* 12,5cm | pz. conf. 50 | c/c 40



€ 3,50



Q2044.Z | cucchiaio nero | *black spoon* 12,5cm | pz. conf. 50 | c/c 40



€ 3,25



Q2041.S | forchetta in cpla | *cpla fork* | cm 16 | pz. conf. 50 | c/c 20



€ 3,25



Q2041.Z | forchetta nera | *black fork* 16cm | pz. conf. 50 | c/c 20



€ 3,50



Q2042.S | cucchiaio in cpla | *cpla spoon* | cm 16 | pz. conf. 50 | c/c 20



€ 3,50



Q2042.Z | cucchiaio nero | *black spoon* 16cm | pz. conf. 50 | c/c 20



€ 2,60



Q2040.S | coltello in cpla | *cpla knife* | cm 16 | pz. conf. 50 | c/c 20



€ 2,60



Q2040.Z | coltello nero | *black knife* 16cm | pz. conf. 50 | c/c 20



€ 6,26



Q2045.S | cucchiaino gelato | *ice cream spoon* 10cm | pz. conf. 100 | c/c 20



€ 74,40



Q2046 | bis posate in cpla | *cpla cutlery set* | cm 16 | pz. conf. 250 (50X5) | c/c 6



€ 46,95



Q2048.S | bis posate in cpla | *cpla cutlery set* | cm 16 | pz. conf. 250 (50X5) | c/c 12



€ 46,95



Q2048.Z | bis posate | *set knife, fork, napkin* 16cm | pz. conf. 250 (5x50pcs) | c/c 12



CPLA compostable



Compostable
7P0829

tappo | lid
Ø 8



€ 87,81

Q3002 | bicchiere bio | *bio cup* |
cm Ø 8x9.2 - 240 ml | pz. conf. 1000
(20x50) | c/c 4

tappo | lid
Ø 9



€ 110,46

H0748.Z | bicchiere Night | *Night cup*
| cm Ø 9x13.3 - ml 470 | pz. conf. 1000
(50x20) | c/c 6



€ 3,30

Q4030 | bicchiere pla | *pla glass* |
ml. 160/200 | pz. conf. 50 | c/c 30

tappo | lid
Ø 9



€ 128,75

Q3003 | bicchiere bio | *bio cup* |
cm Ø 9x10.8 - 350 ml | pz. conf. 1000
(20x50) | c/c 4

tappo | lid
Ø 9



€ 110,46

H0748.T | bicchiere Sunset | *Sunset
cup* | cm Ø 9x13.3 - ml 470 |
pz. conf. 1000 (50x20) | c/c 6



€ 6,09

Q4031 | bicchiere pla | *pla glass* |
ml. 200/300 | pz. conf. 50 | c/c 20

tappo | lid
Ø 9



€ 99,50

Q3004 | bicchiere bio | *bio cup* |
cm Ø 9x13.3 - 470 ml | pz. conf. 1000
(20x50) | c/c 4

tappo | lid
Ø 9



€ 110,46

H0748.G | bicchiere Summer | *Summer
cup* | cm Ø 9x13.3 - ml 470 |
pz. conf. 1000 (50x20) | c/c 6



€ 7,63

Q4032 | bicchiere pla | *pla glass* |
ml. 300/400 | pz. conf. 50 | c/c 20

tappo | lid
Ø 9



€ 58,60

Q3005 | bicchiere bio | *bio cup* |
cm Ø 9x15.9 - 590 ml | pz. conf. 500
(50x10) | c/c 4

tappo | lid
Ø 9



€ 110,46

H0748.K | bicchiere Havana | *Havana
cup* | cm Ø 9x13.3 - ml 470 |
pz. conf. 1000 (50x20) | c/c 6



€ 9,55

Q4033 | bicchiere pla | *pla glass* |
ml. 400/565 | pz. conf. 50 | c/c 16







tappo | lid
Ø 5,5

Pa

€ 20,95

H0729 | bicchiere carta | *paper cup* |
cm Ø 5,5x5,5 - 75 ml |
pz. conf. 1000 (20x50) | c/c 6



tappo | lid
Ø 5,5

NEW

Pa

€ 20,95

H0729.R | bicchiere coffee | *coffee cup* |
cm Ø 5,5x5,5 - ml 75 | pz. conf. 1000 (50x20) | c/c 6



tappo | lid
Ø 6,2

NEW

Pa

€ 25,07

H0730.R | bicchiere coffee | *coffee cup* |
cm Ø 6,2x6,3 - ml 115 | pz. conf. 1000 (50x20) | c/c 6



tappo | lid
Ø 6,2

Pa

€ 25,07

H0730 | bicchiere carta | *paper cup* |
cm Ø 6,2x6,3 - 115 ml |
pz. conf. 1000 (20x50) | c/c 6



tappo | lid
Ø 6,2

PLA

Pa

PLA

€ 44,64

Q3000 | bicchiere carta | *paper cup* |
cm Ø 6,2x6,3 - 115 ml | pz. conf. 1000 (20x50) | c/c 4



tappo | lid
Ø 6,2

Pa

€ 57,40

H0734 | bicchiere doppia parete | *double wall paper cup* |
cm Ø 6,2x6,3 - 115 ml | pz. conf. 1000 (20x50) | c/c 6



tappo | lid
Ø 7

PLA

Pa

PLA

€ 62,37

Q3001 | bicchiere carta | *paper cup* |
cm Ø 7x7,8 - 200 ml | pz. conf. 1000 (20x50) | c/c 4



tappo | lid
Ø 8

Pa

€ 51,14

H0731.V | bicchiere carta | *paper cup* |
cm Ø 8x9 - 240 ml | pz. conf. 1000 (50x20) | c/c 6



tappo | lid
Ø 8

NEW

Pa

€ 51,14

H0731.R | bicchiere coffee | *coffee cup* |
cm Ø 8x9 - ml 240 | pz. conf. 1000 (50x20) | c/c 6



tappo | lid
Ø 8

Pa

€ 51,14

H0731 | bicchiere carta | *paper cup* |
cm Ø 8x9 - 240 ml |
pz. conf. 1000 (20x50) | c/c 6



tappo | lid
Ø 9

Pa

€ 71,79

H0732 | bicchiere carta | *paper cup* |
cm Ø 9x10,2 - 290 ml |
pz. conf. 1000 (20x50) | c/c 6



tappo | lid
Ø 9

Pa

€ 75,15

H0736 | bicchiere doppia parete | *double wall paper cup* |
cm Ø 9x13 - 470 ml | pz. conf. 500 | c/c 6

PLA

€ 60,50

Q3008.100 | tappo in pla | *pla lid* | cm Ø 6,2 | pz. conf. 1000 (10x100) | c/c 4**PLA**

€ 77,00

Q3009 | tappo in pla | *pla lid* | cm Ø 7 | pz. conf. 1000 (20x50) | c/c 4**PLA**

€ 72,10

Q3006 | tappo in pla | *pla lid* | cm Ø 8 | pz. conf. 1000 (10x100) | c/c 4**PS**

€ 28,02

H0740 | tappo nero in ps | *black ps lid* | cm Ø 6,2 | pz. conf. 1000 (20x50) | c/c 6**PS**

€ 39,23

H0741 | tappo nero in ps | *black ps lid* | cm Ø 8 | pz. conf. 1000(20x50) | c/c 6**PS**

€ 58,64

H0742 | tappo nero in ps | *black ps lid* | cm Ø 9 | pz. conf. 1000 (20x50) | c/c 6**PS**

€ 20,30

H0749 | tappo ps nero | *black ps lid* | cm Ø 5,5 | pz. conf. 1000 (50x20) | c/c 6**CEL**

€ 59,54

Q2114 | tappo | *lid* | cm Ø 8 | pz. conf. 500 (10x50) | c/c 6**CEL**

€ 42,44

Q2115 | tappo | *lid* | cm Ø 9 | pz. conf. 500 (10x50) | c/c 6**Pa**

€ 6,10

H0739 | portabicchiere da 2 | 2- *paper cup holder* | cm 17x8x22 | pz. conf. 25 | c/c 8**Pa**

€ 14,05

H0738 | portabicchiere da 4 | 4- *paper cup holder* | cm 29x17,5x3,5 | pz. conf. 50 | c/c 6**Pa**

€ 9,49

H0737 | portabicchiere da 2 | 2- *paper cup holder* | cm 17x11,5x3,5 | pz. conf. 50 | c/c 8





€ 9,85



H8014.N2 | sottobicchiere bordeaux | *burgundy coaster* | cm Ø 9 | pz. conf. 250 | c/c 16



€ 8,09



H8012.2 | sottobicchiere bianco | *white airlaid coaster* | cm Ø 9 | pz. conf. 250 | c/c 16



€ 11,00



H8014 | sottobicchiere colori assortiti | *mixed coasters* | cm Ø 9 | pz. conf. 250 | c/c 16



€ 9,85



H8017 | sottobicchiere cuore | *heart coaster* | cm Ø 9 | pz. conf. 250 | c/c 16



€ 12,38



H8013.T2 | sottocoppa creta | *clay coaster* | cm Ø 11,5 | pz. conf. 250 | c/c 18



€ 12,38



H8013.I2 | sottocoppa giallo | *yellow coaster* | cm Ø 11,5 | pz. conf. 250 | c/c 18



€ 12,38



H8013.M2 | sottocoppa rosso | *red coaster* | cm Ø 11,5 | pz. conf. 250 | c/c 18



€ 12,38



H8013.N2 | sottocoppa bordeaux | *burgundy coaster* | cm Ø 11,5 | pz. conf. 250 | c/c 18



€ 10,51



H8011.2 | sottocoppa bianca | *white airlaid coaster* | cm Ø 11,5 | pz. conf. 250 | c/c 18



€ 12,38



H8013.G2 | sottocoppa blu | *blue coaster* | cm Ø 11,5 | pz. conf. 250 | c/c 18



€ 12,38



H8013.Z2 | sottocoppa nero | *black coaster* | cm Ø 11,5 | pz. conf. 250 | c/c 18



€ 13,59



H8013 | sottocoppa colorate | *mixed coasters* | cm Ø 11,5 | pz. conf. 250 | c/c 18



€ 25,91



H9006.N | sottopiatto bordeaux | *burgundy dish placemat* | cm Ø 21 | pz. conf. 200 | c/c 8



€ 18,59



H9005 | sottopiatto bianco | *white dish placemat* | cm Ø 21 | pz. conf. 200 | c/c 8



€ 20,79



H9004.N | sottopiatto bordeaux | *burgundy dish placemat* | cm Ø 18 | pz. conf. 200 | c/c 8



€ 15,46



H9003 | sottopiatto bianco | *white dish placemat* | cm Ø 18 | pz. conf. 200 | c/c 8



€ 39,60



H9002.Y | sottopiatto
ovatta | *paper* | cm Ø 20 |
pz. conf. 150 | c/c 10



€ 42,24



H8016 | sottobicchiere
ovatta | *paper coaster* | cm
Ø 10 | pz. conf. 500 | c/c 10



€ 7,87



H9007.S | sottopiatto
intreccio grigio | *grey
placemat* | cm Ø 32 |
pz. conf. 12 | c/c 8



€ 68,20



H8007.F | sottobicchieri
ovatta | *paper coaster* |
cm Ø 8,5 | pz. conf. 1000 |
c/c 10

**PIZZO REGAL TONDO 40 gr/mq**

cod.	ø est.	ø int.	pz.	c/c	€
H3110	10	5,3	250	20	1,72
H3112	12	6	250	8	2,18
H3114	14	7,3	250	8	2,45
H3116	16	8	250	8	3,09
H3118	18	10,3	250	8	3,77
H3120	20	11	250	8	4,57
H3124	24	13,8	250	8	5,90
H3128	28	17,9	250	8	8,62
H3130	30	19,5	250	8	10,02
H3132	32	18,4	250	4	10,89
H3134	34	19,8	250	4	12,15
H3136	36	22,5	250	4	14,37

PIZZO SMALTATO TONDO 60 gr/mq

cod.	ø est.	ø int.	pz.	c/c	€
H1414	14	7,3	100	20	1,70
H1417	17	9	100	20	2,21
H1420	20	11	100	20	3,28
H1423	23	12,8	100	20	3,71
H1425	25	15	100	20	4,00
H1428	28	17,9	100	20	5,83
H1430	30	19,5	100	20	6,66
H1432	32	18,4	100	20	6,90
H1434	34	19,8	100	20	8,74
H1436	36	22,5	100	20	8,89
H1438	38	25,4	100	20	9,30
H1440	40	26,3	100	20	9,90

SMALTATO RETTANGOLARE 60 gr/mq

cod.	est.	int.	pz.	c/c	€
H1520	20X30	10X20	100	20	4,87
H1525	25X35	15X24,4	100	20	6,00
H1530	30X40	18X28,5	100	20	8,68
H1535	35X45	22,5X32	100	10	12,48
H1540	40X50	26X36,5	100	10	15,85

**SOTTOFRITTO OVALE 40 gr/mq**

cod.	dim.	pz.	c/c	€
H2216	16x24	500	10	18,24
H2218	18x27	500	10	20,62
H2221	21x32	500	10	28,30
H2222	22x34	500	10	31,51
H2226	26x40	500	5	41,25
H2229	28x46	500	5	52,27
H2232	32x50	500	5	58,79

SOTTOFRITTO TONDO 40 gr/mq

cod.	dim.	pz.	c/c	€
H2115	15	500	10	12,45
H2118	18	500	10	16,58
H2121	21	500	10	19,52
H2123	23	500	10	24,55
H2125	25	500	10	26,10
H2128	28	500	10	26,75
H2130	30	500	10	35,77
H2132	32	500	10	44,34

REGAL RETTANGOLARE 40 gr/mq

cod.	est.	int.	pz.	c/c	€
H3215	15x30	6,9x22	250	8	5,33
H3220	20x30	10x20	250	8	6,72
H3225	25x35	15x24,4	250	8	9,33
H3230	30x40	18x28,5	250	4	12,95
H3235	35x45	22,5x32	250	4	16,12
H3240	40x50	26x36,5	250	4	20,14







€ 115,90  

T6010.P | buste portatovagliolo | serviette holder | cm 14x28 | pz. conf. 500 | c/c 6



€ 39,66  

T2153.P | tovagliette Venice | placemat Venice | cm 30x40 | pz. conf. 500 | c/c 3



€ 25,50  

T6000.G | collarino per bottiglie | bottle collar | cm 11,5x7 | pz. conf. 250 | c/c 20



€ 28,45  

T2152 | tovagliette Dallas | placemat Dallas | cm 30x40 | pz. conf. 500 | c/c 4

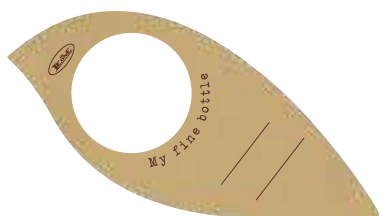

€ 25,50  

T6002 | collarino per bottiglie | bottle collar | cm 11,5x7 | pz. conf. 250 | c/c 20



€ 30,36  

T2153.O | tovagliette Venice | placemat Venice | cm 30x40 | pz. conf. 500 | c/c 3



€ 46,97  

T2153.Z | tovagliette Venice | placemat Venice | cm 30x40 | pz. conf. 500 | c/c 3



€ 51,70 Pa 

T2102 | portaposate Dallas | *cutlery holder*
Dallas | cm tovagl.38x38 2v | pz. conf. 400 |
c/c 12



€ 57,37 Pa 

T2101 | portaposate Dallas | *cutlery holder*
Dallas | cm tovagl.38x38 2v | pz. conf. 500 |
c/c 12



€ 70,13 Pa 

T2103.Z | portaposate Venice | *cutlery holder*
Venice | cm tovagl.38x38 2v | pz. conf. 400 |
c/c 12



€ 70,13 Pa 

T2103.P | portaposate Venice | *cutlery holder*
Venice | cm tovagl.38x38 2v | pz. conf. 400 |
c/c 12



€ 70,13 Pa 

T2103.O | portaposate Venice | *cutlery holder*
Venice | cm tovagl.38x38 2v | pz. conf. 400 |
c/c 12





€ 7,85  

T6335 | salvietta Lemon tree | *Lemon tree wet wipe* | cm 6x8 | pz. conf. 100 | c/c 60



€ 63,45  

T6345 | salviettone Natura | *Natura large wet wipe* | cm 6x14 | pz. conf. 500 | c/c 12



€ 36,95  

T6344 | salvietta Natura | *Natura wet wipe* | cm 6x8 | pz. conf. 500 | c/c 12



€ 35,05  

T6346 | salvietta Mosaico | *Mosaico wet wipe* | cm 6x14 | pz. conf. 300 | c/c 12



€ 35,80  

T6342 | salvietta Green Ice | *Green Ice wet wipe* | cm 6x8 | pz. conf. 500 | c/c 12



€ 61,40  

T6343 | salviettone Green Ice | *Green Ice large wet wipe* | cm 6x14 | pz. conf. 500 | c/c 12



€ 38,65  

T6304.2 | salvietta Sorrento | *Sorrento wet wipe* | cm 9x7 | pz. conf. 500 | c/c 12



€ 33,95  

T6347 | salvietta Mosaico | *Mosaico wet wipe* | cm 9x9 | pz. conf. 300 | c/c 12



€ 40,55  

T6341.TG | salvietta Metal blu | *Metal blue wet wipe* | cm 9x7 | pz. conf. 500 | c/c 12



€ 9,00  

T6339 | salvietta Citronella | *Citronella wet wipe* | cm 7x9 | pz. conf. 100 | c/c 12



€ 51,45  

T6337 | salviette Pesce blu | Blue fish wet wipe | cm 11x8 | pz. conf. 500 | c/c 12



€ 51,00  

T6309.T2 | salvietta Granchio | Crab wet wipe | cm 11x8 | pz. conf. 500 | c/c 12



€ 8,65  

T6334 | salvietta Pagliaccio | Clownfish wet wipe | cm 11x8 | pz. conf. 80 | c/c 60

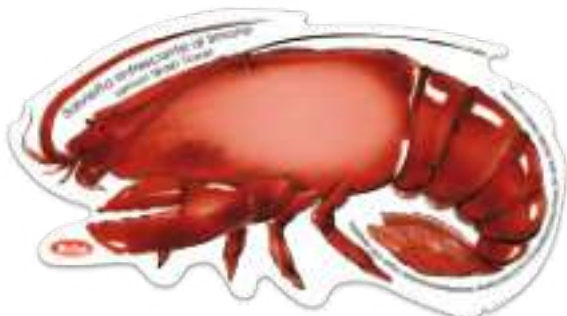

€ 34,40  

T6324.T | salviettone Astice | Lobster wet wipe | cm 15x8 | pz. conf. 250 | c/c 12



€ 8,65  

T6337.C80 | box salviette Pesce blu | *Blue fish wet wipe box* | cm 11x8 | pz. conf. 80 | c/c 60



€ 8,65  

T6304.C100 | box salvietta Sorrento | *Sorrento wet wipe box* | cm 9x7 | pz. conf. 100 | c/c 60



€ 12,80  

T6344.CB150 | box salvietta Natura | *Natura wet wipe box* | cm 6x8 | pz. conf. 150 | c/c 60

IGIENIZZANTI SANITIZING

Gel alcolico igienizzante pronto all'uso per un'azione detergente delle mani, sia in casa che fuori casa.

Alcohol sanitizing gel for a hand cleansing action, ready to use, both at home and away from home.



€ 52,50  

T6403 | gel igienizzante mani | *sanitizing hand gel* | ml 3 | pz. conf. 500 | c/c 12

Pratiche e rinfrescanti, queste salviette sono imbevute con una soluzione a base alcolica al 70% e garantiscono un'efficace azione igienizzante e purificante.

Practical and refreshing, these wipes are soaked in a 70% alcohol-based solution and guarantee an effective sanitizing and purifying action.



€ 40,95  

T6404 | salvietta alcool mani | *sanitizing hand wipe* | cm 7x9 | pz. conf. 400 | c/c 12

Ideali per sanificare tutte le superfici dentro e fuori casa in modo rapido e senza bisogno di risciacquare.

Ideal for sanitizing all surfaces inside and outside the home quickly without rinsing.



€ 33,85  

T6402 | salviettone superfici | *surface wet wipe* | cm 7x14 | pz. conf. 300 | c/c 12



€ 10,06 Pa

T4003 | bustina carta Elite | *paper hat Elite* |
cm 28,2x9 | pz. conf. 100 | c/c 10



€ 10,06 Pa

T4003.R | bustina carta Natura | *paper hat Natura* |
cm 28,2x9 | pz. conf. 100 | c/c 10



€ 17,95 Pa

T4002 | cappello chef in tnt | *tnt chef's hat* |
cm 28,5x24 | pz. conf. 25 | c/c 16



€ 17,95 Pa

T4002.Z | cappello chef in tnt | *tnt black chef's hat* |
cm 28,5x24 | pz. conf. 25 | c/c 16



€ 36,90 TNT

T6205 | bavaglio astice | *lobster bib* |
cm 37x40 | pz. conf. 100 | c/c 5



€ 36,90 TNT

T6201 | bavaglio fiocco | *bow bib* |
cm 37x40 | pz. conf. 100 | c/c 5



€ 23,79 TNT

T6204 | baby bavaglio | *baby bib* |
cm 20x24 | pz. conf. 100 | c/c 12



€ 25,60 TNT

T6200 | bavaglio bianco | *white bib* |
cm 37x40 | pz. conf. 100 | c/c 5



€ 15,27
€ 58,08

sapone flow pack | soap | gr. 10
W3339 | pz. conf. 150 | c/c 6
W3340 | pz. conf. 600 | c/c 12



€ 14,01
€ 65,55

sapone flow pack | soap | gr. 14
W3330 | pz. conf. 100 | c/c 6
W3341 | pz. conf. 500 | c/c 12



€ 12,50
€ 40,10

bustina shower shampoo | ml. 10 |
W3336 | pz. conf. 150 | c/c 6
W3342 | pz. conf. 500 | c/c 12



€ 17,66

W3331 | tubo shower shampoo |
shower shampoo tube | ml. 25 |
pz. conf. 50 | c/c 6



€ 10,64

W3335 | set cucito | sewing kit |
pz. conf. 50 | c/c 12



€ 14,42

W3338 | spugna lucida scarpe |
shoes sponge | | pz. conf. 50 | c/c 6



€ 13,18

W3332 | cuffia doccia imbustata |
sachet shower cap | | pz. conf. 50
| c/c 6



€ 14,85

W3337 | vanity kit | vanity kit |
pz. conf. 50 | c/c 6



€ 26,00

W5200 | strisce garanzia WC | WC
hygienic strips | | pz. conf. 1000 |
c/c 12



€ 35,10

W3334 | set denti | dental kit |
ml. 7 | pz. conf. 50 | c/c 6



€ 33,20

W3333 | set barba | shaving kit |
ml. 10 | pz. conf. 50 | c/c 6



€ 48,00

W5203 | sacchetti igienici |
hygienic bags | pz. conf. 1000 |
c/c 12

LINEA NATURA





€ 58,32
€ 58,50

sapone flow pack | soap

W1014 | gr. 10 | pz. conf. 600 | c/c 12

W1015 | gr. 14 | pz. conf. 500 | c/c 12



€ 10,76

W1013 | sapone flow pack | *flow pack soap* | gr. 10 | pz. conf. 100 | c/c 10



P
€ 22,81

W4603 | set cucito | *sewing kit* | pz. conf. 100 | c/c 10



P
€ 24,80

W1011 | sapone astucciato | *boxed soap* | gr. 18 | pz. conf. 100 | c/c 10



P
€ 30,46

W4113 | vanity kit | *vanity kit* | pz. conf. 100 | c/c 10



P
€ 26,49

W4117 | spugna lucida scarpe | *shoes sponge* | | pz. conf. 100 | c/c 10



P
€ 21,21

W3007 | cuffia doccia astucciata | *boxed shower cap* | | pz. conf. 100 | c/c 10



P
€ 50,75

W2010 | bustina shower shampoo | *shower shampoo sachet* | ml. 10 | pz. conf. 600 | c/c 12



€ 13,55

W3008 | cuffia doccia imbustata | *shower cap sachet* | pz. conf. 100 | c/c 10



€ 29,15

W2012 | tubo shower shampoo | *shower shampoo tube* | ml. 25 | pz. conf. 100 | c/c 5



€ 37,25

W2015 | tubo crema corpo | *body lotion tube* | ml. 25 | pz. conf. 100 | c/c 5



€ 17,55

W1012 | sapone plisse | *round soap* | gr. 15 | pz. conf. 100 | c/c 10

LINEA ACANTO



P
€ 71,25

W4110 | set denti | dental kit |
ml. 7 | pz. conf. 100 | c/c 10



P
€ 55,35

W4106 | set barba | shaving kit |
ml. 10 | pz. conf. 100 | c/c 10



€ 30,97

W5002 | sacchetti per biancheria |
laundry bag | pz. conf. 100 | c/c 10



€ 10,15

W4230.2CB | sapone flow pack | *flow pack soap* | gr. 10 | pz. conf. 100 | c/c 10



18,50

W4230.CB | sapone plisse | *round soap* | gr. 15 | pz. conf. 100 | c/c 10



€ 12,50

W4240.CB | bustina shower shampoo | *shower shampoo sachet* | ml. 10 | pz. conf. 150 | c/c 6



€ 11,60

W4232.CB | cuffia doccia astucciata | *boxed shower cap* | | pz. conf. 50 | c/c 10



€ 14,30

W4238.CB | spugna lucida scarpe | *shoes sponge* | | pz. conf. 50 | c/c 10



€ 19,24

W4237 | cotton fioc | *cotton buds* | pz. 4 | pz. conf. 100 | c/c 10



€ 12,98

W4232.I | cuffia doccia imbustata | *sachet shower cap* | | pz. conf. 100 | c/c 10



€ 27,95

W4239 | fazzolettini da naso | *tissues* | pz. 5 | pz. conf. 100 | c/c 10



€ 10,50

W4235.CB | set cucito | *sewing kit* | pz. conf. 50 | c/c 10



€ 17,50

W4231.CB | tubo bagnodoccia | *shower gel tube* | ml. 30 | pz. conf. 50 | c/c 10

LINEA LOTHO



€ 18,20

NEW

W4241.CB | Vanity kit | *Vanity Kit* |
pz. conf 50 | c/c 10



€ 17,50

W4233.CB | set barba | *shaving set* |
ml. 10 | pz. conf. 25 | c/c 10



€ 37,30

W4236 | pettine astucciato | *boxed comb* |
pz. conf. 100 | c/c 10



€ 19,50

W4234.CB | set denti | *dental kit* |
ml. 7 | pz. conf. 25 | c/c 10



€ 32,05

W2003.Q | flacone bagnodoccia | bathgel bottle | ml. 20 | pz. conf. 100 | c/c 2



€ 32,05

W2003.T | flacone bagnodoccia | bathgel bottle | ml. 20 | pz. conf. 100 | c/c 2



€ 32,05

W2003.F | flacone bagnodoccia | bathgel bottle | ml. 20 | pz. conf. 100 | c/c 2



€ 32,05

W2003.Y | flacone bagnodoccia | bathgel bottle | ml. 20 | pz. conf. 100 | c/c 2



€ 37,80

P

W2007.T | flacone bagnodoccia | bathgel bottle | ml. 30 | pz. conf. 100 | c/c 3



€ 37,80

P

W2007.I | flacone bagnodoccia | bathgel bottle | ml. 30 | pz. conf. 100 | c/c 3



€ 37,80

P

W2007.F | flacone bagnodoccia | bathgel bottle | ml. 30 | pz. conf. 100 | c/c 3



€ 41,90

P

W2008.Y | flacone bagnodoccia | bathgel bottle | ml. 30 | pz. conf. 100 | c/c 2



€ 15,75

W4401.2 | salvietta lucida scarpe | *shiny shoes tissue* | cm 7x9 | pz. conf. 150 | c/c 5



€ 26,25

W2006 | bustina igiene intima | *intimate hygiene sachet* | ml. 5 | pz. conf. 250 | c/c 5



€ 12,60

W7001 | detersivo per piatti | *dishwashing liquid* | ml. 9 | pz. conf. 150 | c/c 12



€ 162,60 **Pa**

W4303.Y | copribicchieri | glass cover |
cm Ø 7 | pz. conf. 1000 | c/c 4



€ 158,28 **Pa**

W4302.Y | copribicchieri | glass cover |
cm Ø 6 | pz. conf. 1000 | c/c 4



€ 23,50 **Pa**

W5201 | strisce garanzia WC | WC *hygienic strips* | | pz. conf. 1000 | c/c 12



€ 48,00 **Pa**

W5101 | sacchetti igienici carta | *hygienic paper bags* | | pz. conf. 1000 | c/c 12



€ 98,50 **PP**

W4301 | bicchiere imbustato | *wrapped glass* | ml. 200 | pz. conf. 1000 | c/c 6



€ 108,90 **PLA**

Q2054 | bicchiere imb. in pla | *wrapped pla glass* | ml. 200 | pz. conf. 400 | c/c 6



€ 76,00

W4502 | scatola cortesia Nuvole | *courtesy box Nuvole* | | pz. conf. 100 | c/c 4

box completi
saponetta 10 g
bagnodoccia 10 ml
cuffia doccia



€ 76,00

W4504.Y | scatola cortesia Poket | *courtesy box Poket* | | pz. conf. 100 | c/c 4

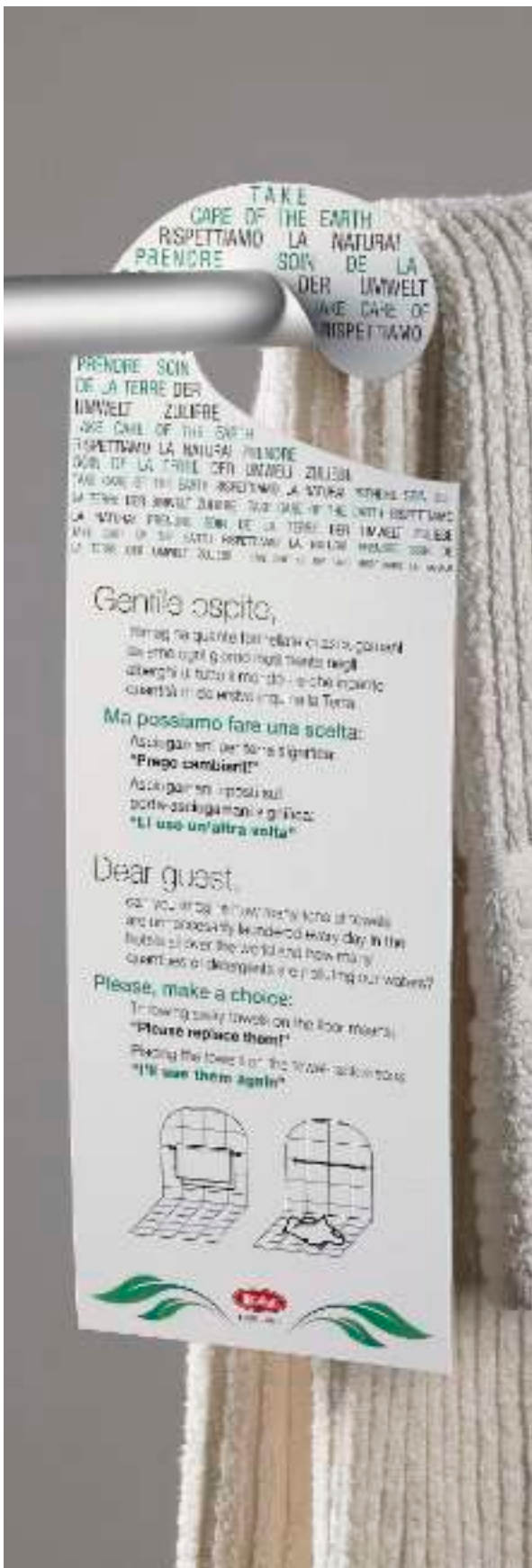

€ 7,65



W4102 | non disturbare | do not disturb card
| | pz. conf. 20 | c/c 25



€ 7,65



W4105 | cambio asciugamani | wash towel
advice card | | pz. conf. 20 | c/c 25



€ 7,11 **Ac**

T5238 | supporto "U" | *display stand "U"* |
cm 25x12x3 | pz. conf. 1 | c/c 36



€ 5,504 **Ac**

T5239 | supporto "T" | *display stand "T"* |
cm 25x17x15 | pz. conf. 1 | c/c 48



€ 4,90 **Ac**

T5240 | supporto | plexiglass | *acrylic display
stand "I"* | cm 25x11,5x16 | pz. conf. 1 | c/c 32



€ 6,00 **Ac**

T5225 | vassoio satinato | *tray* |
cm 15x20x2,7 | pz. conf. 1 | c/c 60



€ 5,58 **Ac**

T5237 | vassoio | *tray* |
cm 20x8x3 | pz. conf. 1 | c/c 48





€ 3,87 **W**

S0061 | vassoio bamboo | *bamboo tray* |
cm 15x15x2,5 | pz. conf. 1 | c/c 36



€ 5,37 **W**

S0062 | vassoio bamboo | *bamboo tray* |
cm 30x11x2,5 | pz. conf. 1 | c/c 36



€ 22,18 **PP**

T0514 | cestino bianco | *white basket* |
cm 14x11x5 | pz. conf. 10 | c/c 10



€ 5,37 **W**

S0070 | vassoio nero | *black tray* |
cm 24x9x2,5 | pz. conf. 1 | c/c 48



€ 7,41 **PP**

T0560.Z | cestino nero | *black basket* |
cm 16x13x6 | pz. conf. 1 | c/c 36



€ 7,41 **PP**

T0560.Y | cestino bianco | *white basket* |
cm 16x13x6 | pz. conf. 1 | c/c 36



€ 4,90 **MF**

T8517 | vaschetta quadrata | *square tray* |
cm 15x15x6 | pz. conf. 1 | c/c 16



€ 4,65 **MF**

T8516 | vaschetta rettangolare | *rect. tray* |
cm 22x15x3,5 | pz. conf. 1 | c/c 16





€ 18,88

W4711 | ciabatta spugna | terry slippers |
pz. conf. 12 paia | c/c 4



€ 83,30

W4709.Z | ciabatte spugna black | black
terry slippers | | pz. conf. 50 paia | c/c 4



€ 53,34

W4708 | ciabatte spugna chiuse | closed
terry slippers | | pz. conf. 50 paia | c/c 10



€ 52,17

W4702 | ciabatte spugna | terry slippers |
pz. conf. 50 paia | c/c 10



€ 71,02 

W4706 | ciabatte tnt | tnt slippers |
pz. conf. 100 paia | c/c 12



€ 52,17

W4707 | ciabatte spugna aperte | opened
terry slippers | | pz. conf. 50 paia | c/c 10





€ 14,19 **W**

W4330.Y | gruccia bianca | *white hanger* |
pz. conf. 6 | c/c 8



€ 3,78 **SS**

W4332 | anello antifurto | *anti-theft ring for
hanger* | | pz. conf. 6 | c/c 50



€ 14,19 **W**

W4330.Z | gruccia nera | *black hanger* |
pz. conf. 6 | c/c 8



€ 14,55 **W**

W4331.Z | gruccia nera | *black hanger* |
pz. conf. 6 | c/c 8



€ 30,64  

S5058 | vassoio rettangolare | acacia buffet tray | cm 52x38x5 | pz. conf. 1 | c/c 4



€ 65,57 

W5102 | reggivaligia in acciaio | steel support for suitcase | cm 42x65x72 | pz. conf. 1 | c/c 6



€ 36,97  

S0069.L | vassoio con supporti | tray with holders | cm 58x35x5 | pz. conf. 1 | c/c 4



€ 49,79  

W5104 | reggivaligia in bamboo | bamboo support for suitcase | cm 65x36x51 | pz. conf.



€ 27,17  

S0069 | vassoio con supporti | tray with holders | cm 44x27x5 | pz. conf. 1 | c/c 6



€ 115,79  

W5103 | reggivaligia in legno | wooden support for suitcase | cm 65x36x51 | pz. conf.





€ 3,75 **AI** 

P5111 | borraccia in alluminio | *aluminium bottle* | cm Ø 7,3x22 - 750 ml | pz. conf. 1 | c/c 12



€ 28,99

P5100.Z | bollitore elettrico | *black kettle* | cm Ø 16x 23 - 1,7 l | pz. conf. 1 | c/c 4



€ 22,00 **PP**

T0535 | cestino da camera | *round bin* | cm Ø 26x30 | pz. conf. 1 | c/c 12



€ 8,87 **SS**

T5246 | campanello reception | *reception call bell* | cm Ø 10 | pz. conf. 1 | c/c 6

- Potenza/ Power
1500 W
- Voltaggio/
Voltage 220-240 V
- Design ergonomico
con luce rossa per
accensione/
*Ergonomic design
with red light when
the kettle is working*
- Interno in acciaio
inox /*stainless steel
inner*
- Garanzia 1 anno /
Warranty 1 year
- Conforme alle
norme CE/
*Complies with CE
regulations*



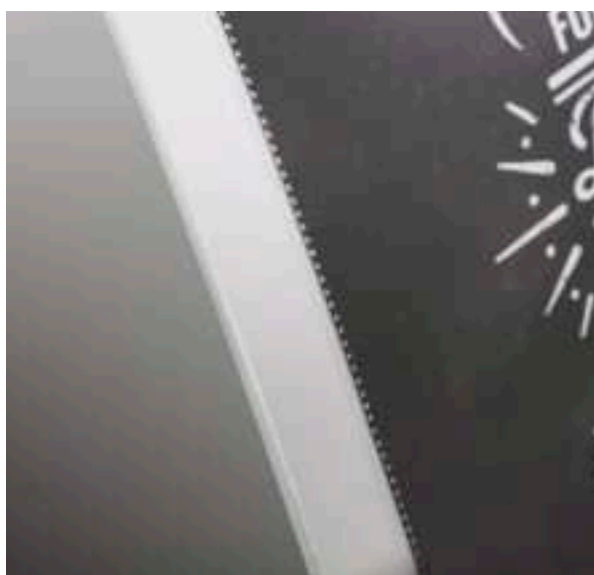
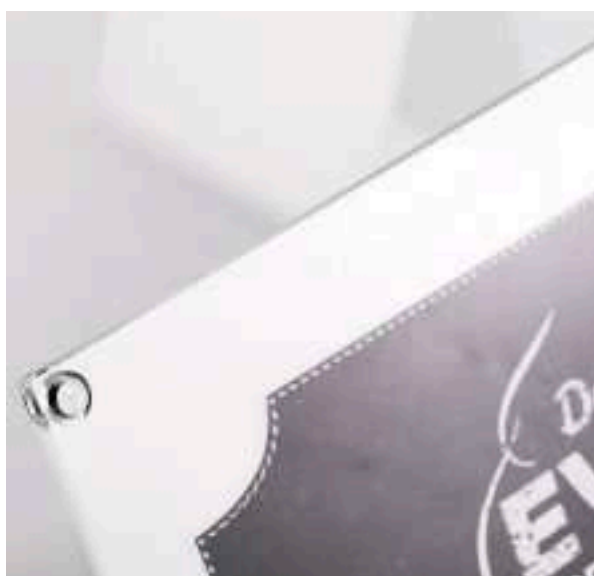
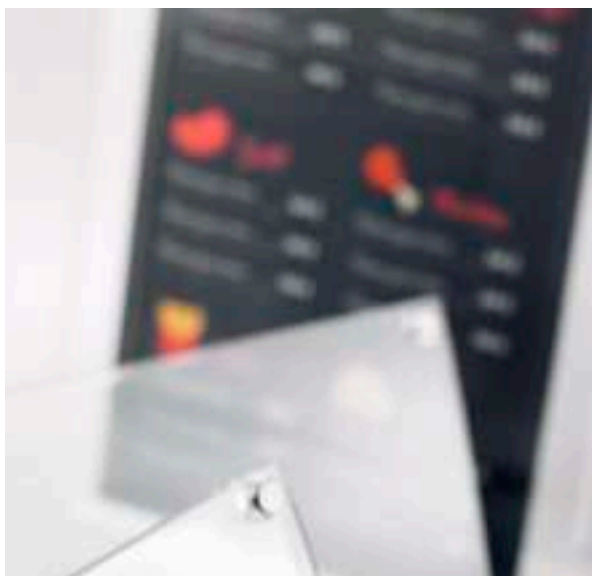
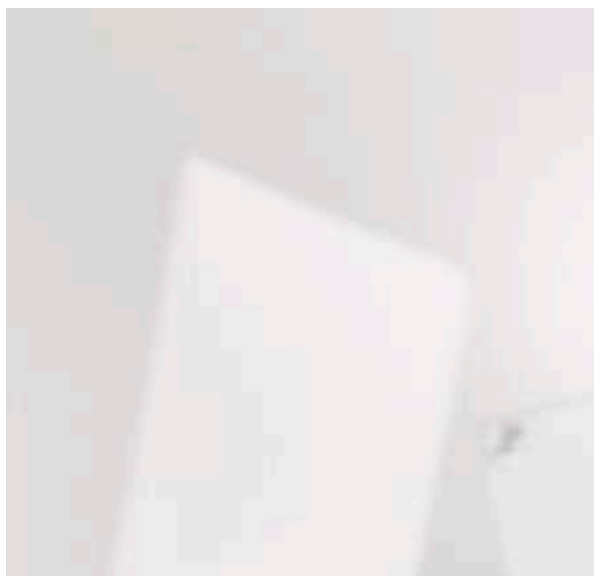



Ac
€ 2,75

T5228 | supporto | *card stand* |
cm 8,5x5 | pz. conf. 1 | c/c 100



Ac
€ 2,00

T5222 | segnagusti | *single card stand* |
cm 5,5x8,5x2 | pz. conf. 1 |
c/c 288



Ac
€ 3,31

T5223 | portabiglietti da visita |
card holder | cm 6,5x10x4,5 |
pz. conf. 1 | c/c 96



!
Ac
€ 5,33

T5208 | portadepliant | *display stand* |
cm 22x31 - A4 | pz. conf. 1 |
c/c 72



Ac
€ 4,42

T5207 | portadepliant | *display stand* |
cm 16x18 - A5 | pz. conf. 1 |
c/c 48



Ac
€ 2,83

T5206 | portadepliant | *display stand* |
cm 10,5x13 | pz. conf. 1 |
c/c 24



Ac
€ 10,59

T5229 | supporto diritto | *acrylic straight display* - A4 |
cm 21x29 - A4 | pz. conf. 1 | c/c 24



Ac
€ 11,74

T5226 | supporto curvato | *curved display* |
cm 21x29 - A4 | pz. conf. 1 |
c/c 24



Ac
€ 1,13

T5210 | supporto "L" | *display stand "L"* |
cm 6,25x8,75 | pz. conf. 1 | c/c 480



Ac
€ 5,89

T5230 | supporto diritto | *straight display* |
cm 14,8x21 - A5 | pz. conf. 1 |
c/c 48



Ac
€ 7,10

T5234 | supporto "L" | *display stand "L"* |
A4 | pz. conf. 1 | c/c 24



Ac
€ 3,31

T5235 | supporto "L" | *display stand "L"* |
A5 | pz. conf. 1 | c/c 48



€ 3,61 **Al** **Ac**

T5274 | porta targa a scatto | snap frame
| cm 18x12 - A6 | pz. conf. 1 | c/c 24

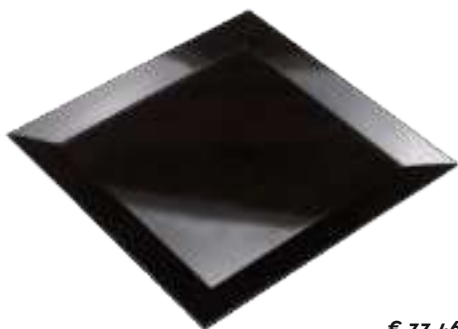

~~€ 33,46~~
€ 18,40



T8018.Z | vassoio nero | *black tray* |
cm 50x50x3 | pz. conf. 1 | c/c 6



~~€ 12,87~~
€ 7,05



T8330 | vassoio effetto legno | *wood effect tray* |
cm 32x17x1,5 | pz. conf. 1 | c/c 12



~~€ 10,71~~
€ 5,35



T8116.Y | bacchette avorio | *ivory chopsticks* |
cm 27 | pz. conf. 10 | c/c 20



~~€ 26,93~~
€ 14,80



T8335 | tagliere effetto legno | *wood effect tray* |
cm Ø 36x1,6 | pz. conf. 1 | c/c 12



~~€ 3,47~~
€ 1,55



T8034 | ciotola tonda | *round bowl* |
cm Ø 13x4 | pz. conf. 1 | c/c 40



~~€ 3,90~~
€ 1,75



T8035 | piatto tondo | *round dish* |
cm Ø 18,6x2,7 | pz. conf. 1 | c/c 64



~~€ 8,62~~
€ 5,60



T8607 | piatto decorato | *decorated plate* |
cm Ø 35 | pz. conf. 1 | c/c 12



~~€ 10,20~~
€ 6,60



T8609 | ciotola decorata | *decorated bowl* |
cm Ø 30 | pz. conf. 1 | c/c 10



€ 2,88 PS !
€ 1,35

F0039 | scatoletta | mini box |
cm 10x5x2 - ml.70 | pz. conf. 12 | c/c 24



€ 5,82 PS !
€ 2,80

F0046 | set mini tortiere | cake holder set |
cm Ø 9,2x10,5 | pz. conf. 9 | c/c 24



€ 5,36 PP !
€ 2,80

F0030 | casseruola nera | black casserole |
cm 15,6x10x7,3 | pz. conf. 6 | c/c 24



€ 5,87 PP !
€ 3,10

F0040 | vassoietto | little tray |
cm 18x12x1,6 | pz. conf. 12 | c/c 24



€ 6,59 SL !
€ 4,28

T9005 | vassoio ardesia | slate tray
cm 15x15x0,5 | pz. conf. 3 | c/c 16



€ 52,02 Pa !
€ 19,90

H0745 | fascetta in carta | paper sleeve |
cm 3x2,6x3,4 | pz. conf. 1000 (50x20) | c/c 6



SALVIETTA IMBEVUTA















- Imballaggio esterno accoppiato: polietilene, alluminio, carta. Salvietta interna in **CELLULOSA COMPOSTABILE**
- Profumazioni disponibili: Limone, The verde, Citronella/Geranio.
- Impianti stampa € 59,00 per colore
- Scatole standard da 500 pezzi.
- Nella produzione verrà inserito e fatturato il fine lavorazione che potrà variare dal 5 al 10% in più dell'ordine.
- Prezzi su preventivo sulla quadricromia, colori a pantone o per materiali differenti dai nostri standard.
- Supplemento carta avana +5%

CUSTOMIZED REFRESHING TOWEL

- Coupled outer packaging: polythene, aluminium, paper. Internal towel made in **COMPOSTABLE CELLULOSE**
- Flavourings available: lemon, green tea, lemongrass/geranium.
- Printing plants € 59,00/each color
- Standard cartons made of 500 pieces.
- During the production from 5% to 10% from the ordered quantity come out: this quantity will be invoiced finally.
- Prices for quadrichromy, colors (pantone) or for different materials than our standards: only on demand.
- Brown paper extra charge +5%

RINCE-DOIGTS PERSONNALISÉ

- Emballage extérieur doublé: polythène, aluminium et papier. Rince-doigts à l'intérieur en **CELLULOSE COMPOSTABLE**
- Aromatisations disponibles: citron, the vert, citronnelle/géranium.
- Installation d'impression: € 59,00/par couleur
- Carton standard de 500 pièces.
- Pendant la production, une différence du 5% au 10% sur la quantité commandées peut sortir et sera facturée.
- Prix sur la quadrichromie, couleurs à pantone et matières premières différentes de nos standards.
- Havane papier supplément +5%

COD.		esterno	salvietta	PCS	1 COL.	2 COL.	3 COL.	
500 PEZZI								
	T6305		60x80	19x10,5	10000	38,45	44,99	48,13
					20000	33,53	37,90	38,44
					50000	29,74	30,98	31,53
					100000	27,31	27,85	28,23
	T6306		70x90	19x12,5	10000	41,10	49,48	50,78
					20000	36,24	39,42	41,10
					50000	30,28	31,74	32,34
					100000	29,63	30,18	30,66
	T6308		70x106	19x14	10000	43,91	51,38	53,48
					20000	38,99	42,23	43,80
					50000	33,09	34,23	34,88
					100000	32,23	32,77	33,09
	T6316		60x140	19x19	10000	51,48	58,35	61,59
					20000	46,77	50,35	51,91
					50000	40,45	41,58	42,23
					100000	39,58	40,13	40,45
	T6323		70x140	19x19	10000	52,34	59,27	62,51
					20000	48,02	51,26	52,78
					50000	40,99	42,56	43,10
					100000	40,78	40,99	40,88
	T6306.TQ		90x90	19x12,5	10000	46,99	52,78	56,72
					20000	41,53	44,77	46,45
					50000	40,45	37,31	38,55
					100000	34,12	34,66	35,31
 	T6303S T6309S		110x70	19x12,5	10000	57,80	62,51	66,50
					20000	52,24	55,92	57,92
					50000	39,91	41,64	42,34
					100000	39,58	40,13	41,58



PERSONALIZZAZIONE ARTICOLI VARI

1. Inviare il vostro ordine indicando l'articolo che desiderate personalizzare e il colore di stampa, allegando il vostro logo in originale (formato PDF HD o vettoriale).
 2. Effettuata l'elaborazione del logo verrà inviata una bozza
 3. Completato il controllo della bozza, inviare mail di conferma
- **TEMPI DI CONSEGNA** possono variare dai 30/60 giorni in base all'articolo e al periodo dell'anno.
 - **COSTO DELL'IMPIANTO STAMPA € 59,00**
Verrà addebitato solo al primo ordine o ad ogni modifica dei dati, o del tipo di impianto (A, B vedi listino seguente).



cod.	articolo	min. pz.	impianto
W1011S	sapone astucciato 18gr		
Acanto	<i>boxed soap 18gr</i>	1000	A
W2010S	bustina doccia shampoo 10ml		
Acanto	<i>bath gel & shampoo 10ml</i>	1200	A
W3007S	cuffia doccia astucciata		
Acanto	<i>boxed shower cap</i>	500	A
W4106S	set barba astucciato		
Acanto	<i>boxed shaving kit</i>	200	A
W4110S	set spazzolino dentifricio		
Acanto	<i>toothbrush & paste set</i>	200	A
W4113S	cotton fioc 4pcs		
Acanto	<i>cotton bud 4pcs</i>	200	A
W4117S	spugna lucidascarpe		
Acanto	<i>shoes sponge</i>	200	A
W4603S	set cucito		
Acanto	<i>sewing kit</i>	200	A
W2007SI	doccia shampoo giallo 30ml		
Tulip	<i>yellow shower shampoo 30ml</i>	500	A
W2007SF	doccia shampoo azzurro 30ml		
Tulip	<i>blue shower shampoo 30ml</i>	500	A
W2007ST	doccia shampoo traspar. 30ml		
Tulip	<i>transp. shower shampoo 30ml</i>	500	A
W2008SY	doccia shampoo bianco 30ml		
Dalia	<i>white shower shampoo 30ml</i>	500	A
L1S1	stuzzicadenti 2 punte imbustati		
	<i>wrapped toothpicks</i>	10000	B
L1S2	stuzzicadenti 2 punte imbustati		
	<i>wrapped toothpicks</i>	20000	B
T6303S	salvietta pesce blu al limone		
	<i>blu fish lemon wet wipe</i>	1000	A
T6304S	salvietta al limone		
	<i>lemon wet wipe</i>	1000	A
T6309S	salvietta granchio al limone		
	<i>crab lemon wet wipe</i>	1000	A
T6324S	salvietta astice al limone		
	<i>lobster lemon wet wipe</i>	1000	A

Per sottobicchieri e infripiatti in ovatta
minimo d'ordine 5000 pezzi.

Richiedere preventivo a:

info@leonedecorazioni.com

INDICE | INDEX

Art.	pag.	Art.	pag.	Art.	pag.	Art.	pag.	Art.	pag.
B051	217	G5002	158	H0742	264	H1432	268	H6120	136
B18	217	G5021	158	H0745	297	H1434	268	H6133	136
B1S	217	G5023	158	H0746.V	242	H1436	268	H6140	136
B2	212	G5033	158	H0747.V	242	H1438	268	H6212	136
B206.N	217	H0701	245	H0748.G	260	H1440	268	H6215	136
B36.1	217	H0702	245	H0748.K	260	H1520	268	H6220	136
B36L.1	217	H0703	244	H0748.T	260	H1525	268	H6228	136
B36S	217	H0704	244	H0748.Z	260	H1530	268	H6231	136
B940	209	H0705	245	H0749	264	H1535	268	H6233	136
B941	209	H0706	245	H0751	244	H1540	268	H6238	136
B943	209	H0707	242	H0752	244	H1611	215	H6240	136
B946	209	H0708	242	H0753	244	H2115	268	H6312	136
B947	209	H0708.V	242	H0754	244	H2118	268	H6315	136
B948	209	H0710	243	H0755	244	H2121	268	H6320	136
B949	209	H0711	242	H0756	244	H2123	268	H6333	136
B950	209	H0712	242	H0757	245	H2125	268	H6340	136
B951	209	H0712.V	242	H0758	248	H2128	268	H6600	138
B952	209	H0713	244	H0758.Z	249	H2130	268	H6601	138
B961	208	H0714	244	H0759	248	H2132	268	H6602	138
BIO913	208	H0715	252	H0759.V	248	H2216	268	H6603	138
BIO920.Y	208	H0716	252	H0759.Z	249	H2218	268	H6604	138
BIO920.Z	208	H0717	252	H0760	249	H2221	268	H6605	138
BIO921.Z	208	H0718	252	H0761	248	H2222	268	H6606	138
BIO922.Y	208	H0719	242	H0761.Z	249	H2226	268	H6607	138
BIO922.Z	208	H0720	251	H0762	249	H2229	268	H8007.F	267
BIO923	208	H0721	251	H0763	248	H2232	268	H8011.2	266
C0013	198	H0722	251	H0764	249	H3110	268	H8012.2	266
C0020.O	198	H0723	251	H0765	246	H3112	268	H8013	266
C0020.Y	198	H0724	243	H0766	246	H3114	268	H8013.G2	266
C0109.A	198	H0725	243	H0767	246	H3116	268	H8013.I2	266
C0109.F	198	H0726	243	H0768	246	H3118	268	H8013.M2	266
C0112.O	198	H0727	242	H0769	246	H3120	268	H8013.N2	266
C0112.Y	198	H0728	243	H0770	246	H3124	268	H8013.T2	266
C0261	198	H0729	263	H0771	246	H3128	268	H8013.Z2	266
C3003	199	H0729.R	263	H0772	246	H3130	268	H8014	266
C3003.Z	199	H0730	263	H0773	246	H3132	268	H8014.N2	266
C3006	199	H0730.R	263	H0801	250	H3134	268	H8016	267
C3009.G	199	H0731	263	H0802	250	H3136	268	H8017	266
F0030	297	H0731.R	263	H0803	250	H3215	268	H9002.Y	267
F0039	297	H0731.V	263	H0804	250	H3220	268	H9003	266
F0040	297	H0732	263	H0805	250	H3225	268	H9004.N	266
F0046	297	H0734	263	H1414	268	H3230	268	H9005	266
G2763	158	H0736	263	H1417	268	H3235	268	H9006.N	266
G2763PP	158	H0737	264	H1420	268	H3240	268	H9007.S	267
G2764	158	H0738	264	H1423	268	H6020	136	L1	216
G2764PP	158	H0739	264	H1425	268	H6033	136	L101	216
G5000	158	H0740	264	H1428	268	H6112	136	L102	216
G5001	158	H0741	264	H1430	268	H6115	136	L103	216

Art.	pag.	Art.	pag.	Art.	pag.	Art.	pag.	Art.	pag.
L2	216	P2136	146	Q1007	220	Q2035	236	Q2087	225
P1001	141	P2137	146	Q1011	221	Q2036	236	Q2088	224
P1003	141	P2138	146	Q1012	221	Q2037	236	Q2089	224
P1004	152	P2139	148	Q1013	221	Q2040.S	258	Q2090	234
P1005	154	P2140	148	Q1014	221	Q2040.Z	258	Q2091	232
P1006	154	P2141	148	Q1015	220	Q2041.S	258	Q2092	232
P1007	143	P2142	148	Q1016	219	Q2041.Z	258	Q2093	234
P1007.T	143	P2143	148	Q1017	219	Q2042.S	258	Q2094	234
P1008	143	P2144	148	Q1018	219	Q2042.Z	258	Q2095	234
P1009	143	P2145	148	Q1019	218	Q2043.S	258	Q2096	234
P1010	143	P3000	160	Q1020	218	Q2043.Z	258	Q2099	230
P1011	154	P3003	160	Q1021	218	Q2044.S	258	Q2100	230
P2000	144	P3004	160	Q1022	218	Q2044.Z	258	Q2101	230
P2001	144	P3005	171	Q1023	219	Q2045.S	258	Q2102	230
P2002	144	P3007	162	Q1025	219	Q2046	258	Q2103	230
P2003	144	P3008	162	Q1027	218	Q2048.S	258	Q2104	232
P2004	144	P3009	162	Q1028	219	Q2048.Z	258	Q2105	232
P2010	144	P3010	162	Q1030	220	Q2054	284	Q2106	232
P2100	151	P3011	162	Q1031	220	Q2057	239	Q2107	230
P2101	151	P3012	162	Q1032	220	Q2058	239	Q2108	230
P2102	152	P3013	162	Q1033	220	Q2059	239	Q2109	230
P2103	152	P3015	163	Q2000	236	Q2060	228	Q2110	230
P2104	150	P3016	163	Q2001	236	Q2060.C	228	Q2111	226
P2105	150	P3017	163	Q2002	236	Q2061	228	Q2112	226
P2106	152	P3018	162	Q2003	236	Q2062	228	Q2113	226
P2107	152	P3019	162	Q2004	238	Q2063	229	Q2114	264
P2108	152	P3022	163	Q2005	238	Q2064	238	Q2115	264
P2109	145	P3023	162	Q2006	236	Q2065	225	Q2116	228
P2110	145	P3024	163	Q2007	236	Q2066	233	Q2117	227
P2111	145	P4000	200	Q2008	238	Q2066.C	233/234	Q2118	227
P2112	145	P4001	200	Q2009	238	Q2067	233	Q2119	227
P2113	145	P4002	200	Q2010	224	Q2068	233	Q2120	227
P2114	145	P4003	200	Q2011	224	Q2069	228	Q2121	227
P2119	150	P4004	200	Q2012	224	Q2070	229	Q2122	227
P2120	150	P4005	200	Q2013	224	Q2071	229	Q2123	227
P2121	151	P4006	200	Q2014	225	Q2072	225	Q2124	227
P2122	151	P4007	169	Q2015	225	Q2073	234	Q2125	228
P2123	147	P4008	169	Q2016	225	Q2074	234	Q3000	263
P2124	147	P5000	72	Q2017	224	Q2075	234	Q3001	263
P2125	147	P5001	72	Q2018	224	Q2076	234	Q3002	260
P2126	147	P5002	72	Q2019	224	Q2077	228	Q3003	260
P2127	147	P5003	72	Q2020	224	Q2078	228	Q3004	260
P2128	147	P5004	73	Q2021	224	Q2079	229	Q3005	260
P2129	147	P5006	73	Q2022	226	Q2080	229	Q3006	264
P2130	147	P5007	72	Q2023	226	Q2081	229	Q3008.100	264
P2131	146	P5100.Z	292	Q2024	233	Q2082	229	Q3009	264
P2132	146	P5102	74	Q2025	224	Q2083	230	Q4000	254
P2133	146	P5103	74	Q2030	239	Q2084	230	Q4001	254
P2134	146	P5111	292	Q2031	239	Q2085	230	Q4003	254
P2135	146	Q1001	220	Q2034	236	Q2086	229	Q4004	254

Art.	pag.	Art.	pag.	Art.	pag.	Art.	pag.	Art.	pag.
Q4005	256	S0010S	211	S0043.S	206	S0088	112	S0203	134
Q4006	256	S0011.2	210	S0044	207	S0089	111	S0203.P	134
Q4007	256	S0011.Z	210	S0044.S	207	S0090	105	S0204	134
Q4008	256	S0012.2	210	S0045	207	S0090.Z	105	S0204.P	134
Q4009	256	S0012.Z	210	S0045.S	207	S0091	99	S0205	134
Q4010	256	S0014	211	S0046	207	S0092	99	S0205.P	134
Q4011	255	S0014S	211	S0046.S	207	S0094	102	S0206	134
Q4012	255	S0015	210	S0047	207	S0095	108	S0210.P	134
Q4013	255	S0015.Z	210	S0047.S	207	S0096	108	S0211	135
Q4016	255	S0016	213	S0048	207	S0097	120	S0212	135
Q4017	255	S0016.M	213	S0048.S	207	S0100	102/114	S0215	135
Q4018	256	S0016.Z	213	S0049.S	206	S0101	114	S0300	192
Q4019	256	S0017	211	S0050.S	206	S0102	102	S0301	192
Q4020	256	S0017S	211	S0051.S	207	S0103	102	S0302	192
Q4021	256	S0018	213	S0052.S	206	S0104	109	S0303	192
Q4030	260	S0019	212	S0053.S	206	S0105	111	S0304	192
Q4031	260	S0020	218	S0054.S	206	S0105.Y	111	S1000	112
Q4032	260	S0021	212	S0058	221	S0105.Z	111	S1001	112
Q4033	260	S0022	212	S0059	221	S0106	204	S1003	115
Q5000.K	240	S0024	211	S0060	108	S0107	204	S1004	115
Q5001.K	240	S0025	213	S0060.L	108	S0108	108	S1005	103
Q5015.K	240	S0026	213	S0060.S	108	S0109	215	S1006	118
Q5030.K	240	S0027	212	S0060.XL	108	S0109.R	215	S1007	118
Q5100.K	241	S0028	212	S0061	104/287	S0110	215	S2001	212
Q5101.K	241	S0029.Z	210	S0061.Z	104	S0110.R	215	S2003	213
Q5110	241	S0030	202	S0062	104/287	S0111	98	S2005	213
Q5115.K	241	S0030.Z	202	S0062.Z	104	S0112	98	S4000	106
Q5130.K	241	S0031	202	S0063	105	S0113	98	S4001	109
Q6000	223	S0031.Z	202	S0063.Z	105	S0118	104	S4002	109
Q6001	223	S0032	202	S0069	290	S0119	104	S4003	109
Q6002	223	S0032.Z	202	S0069.L	290	S0121	99	S4004	109
Q6003	223	S0033	202	S0070	287	S0122	99	S4005	103
Q6004	222	S0033.Z	202	S0071	187	S0123	101	S4006	109
Q6005	222	S0034	202	S0072	99	S0124	101	S4007	100
Q6006	222	S0034.Z	202	S0073	99	S0125	101	S4008	100
Q6007	222	S0035.F	204	S0074	102	S0126	102	S4009	100
Q6008	222	S0035.K	204	S0075.Z	207	S0127	111	S4010	100
Q6009	222	S0035.S	204	S0076	191	S0128	120	S4011	100
Q6010	222	S0037	204	S0077	214	S0128.Z	120	S4012	100
Q6011	222	S0037.P	204	S0077.Z	214	S0130	120	S4013	100
Q6012	222	S0037.T	204	S0078	110/170	S0131	118	S4014	100
Q6013	222	S0037.Z	204	S0079	110/170	S0132	118	S4015	106
S0002	211	S0038.F	204	S0081	98	S0133	117	S4016	106
S0005	216	S0038.T	204	S0082	98	S0134	117	S4017	106
S0006	216	S0039	212	S0083	106	S0135	116	S4100	96
S0007.2	211	S0041	206	S0085	110	S0136	116	S4101	96
S0007S	211	S0041.S	206	S0085.Z	110	S0201	134	S4102	96
S0008	210	S0042	206	S0086	110	S0201.P	134	S4103	96
S0009.2	213	S0042.S	206	S0086.Z	110	S0202	134	S4104	97
S0010.2	211	S0043	206	S0087	112	S0202.P	134	S4105	97

Art.	pag.	Art.	pag.	Art.	pag.	Art.	pag.	Art.	pag.
S4106	97	S5044	80	T0520.Z	133	T0565	128	T2103.O	271
S4107	97	S5045	88	T0525	126	T0565.Z	128	T2103.P	271
S4108	96	S5046	88	T0527	126	T0570	125	T2103.Z	271
S4109	96	S5047	86	T0528	127	T0573	125	T2152	270
S4110	96	S5048	86	T0529.A	133	T0574	78	T2153.O	270
S4111	96	S5049	76	T0529.P	133	T0575.L	78	T2153.P	270
S4112	111	S5050	76	T0529.T	133	T0575.M	78	T2153.Z	270
S4114	106	S5051	76	T0529.Y	133	T0576.L	78	T2200.P12	183
S4115	97	S5052	76	T0529.Z	133	T0576.M	78	T2200.U12	183
S5000	84	S5053	75	T0530.R	132	T0576.S	78	T2203.P12	185
S5000.R	84	S5054	75	T0531.R	132	T0577	79	T2203.R12	185
S5000.T	84	S5055	79	T0532.R	132	T0580.Y	52	T2203.T12	185
S5001	84	S5056	79	T0533.R	132	T0580.Z	52	T2204.P	185
S5001.R	84	S5057	79	T0534	126	T0581.Y	52	T2204.R	185
S5001.T	84	S5058	290	T0534.A	126	T0581.Z	52	T2204.T	185
S5002	84	S5059	95	T0535	292	T0582.Y	52	T2206.A12	187
S5002.R	84	S5060	95	T0536	127	T0582.Z	52	T2207.A	187
S5002.T	84	S5061	95	T0537	124	T0583.Y	52	T2207.R	187
S5003	81	S5062	92	T0540	127	T0583.Z	52	T2211.M12	183
S5004	80	S5063	92	T0544	126	T0584.Y	52	T2211.R12	183
S5005	81	S5064	91	T0545	126	T0584.Z	52	T2211.V12	183
S5006	81	S5065	91	T0546	127	T0585.Y	52	T2213.P	184
S5009	93	S5066	91	T0547	124	T0585.Z	52	T2213.R	184
S5010	93	S5067	91	T0547.Y	124	T0586.Y	52	T2213.Y	184
S5011	93	S5068	90	T0548	124	T0586.Z	52	T2213.Z	184
S5012	93	S5100	86	T0548.Y	124	T0587.Y	52	T2214.P12	187
S5013	92	S5101	86	T0549	124	T0587.Z	52	T2214.R12	187
S5014	92	S5102	82	T0549.Y	124	T1001	173	T2214.Z12	187
S5015	92	S5103	88	T0550	88/114/124	T1001.Z	173	T2215	187
S5016	92	S5104	88	T0551	88/114/124	T1002	173	T2216	187
S5017	93	SB1M.2	217	T0552	124	T1002.Z	173	T2217	183
S5018	93	SK1	216	T0553	46	T1003.M	173	T2218	182
S5021	80	SP1	214	T0554	124	T1003.Y	173	T2221.P4	182
S5022	81	SP2S	214	T0558.R	130	T1003.Z	173	T2221.Z4	182
S5023	81	SP3S	214	T0558.T	130	T1004.A	172	T2223	183
S5024	80	SP4S	214	T0558.Z	130	T1004.P	172	T3010	178
S5025	80	SP5	214	T0559.R	130	T1004.V	172	T3011	178
S5026	75	SP5S	214	T0559.T	130	T1005.K	172	T3012	178
S5027	94	T0003.R	129	T0559.Z	130	T1005.Z	172	T3013	178
S5028	94	T0003.Z	129	T0560.Y	287	T1007	172	T3015	178
S5029	94	T0004.R	129	T0560.Z	287	T1008	172	T3016	178
S5030	94	T0004.Z	129	T0561.R	130	T1009	172	T3017	74
S5031	74	T0005.Z	129	T0561.T	130	T1028	171	T3018	181
S5032	94	T0006.R	129	T0561.Y	130	T1029	171	T3019	181
S5033	94	T0006.Z	129	T0561.Z	130	T1038	171	T3022	180
S5034	95	T0501	132	T0562	128	T1039	171	T3023	180
S5035	95	T0505	132	T0562.Z	128	T2000	253	T3024	181
S5040	77	T0508	168	T0563	128	T2001	253	T3025	180
S5041	77	T0509	168	T0563.Z	128	T2002	253	T3026	180
S5042	77	T0514	287	T0564	128	T2101	271	T3102.L	181
S5043	80	T0520.Y	133	T0564.Z	128	T2102	271	T3102.M	181

Art.	pag.	Art.	pag.	Art.	pag.	Art.	pag.	Art.	pag.
T3200	179	T5026	170	T5106	88	T5426	141	T6403	274
T3201	179	T5027	170	T5121	175	T5431.M	141	T6404	274
T3202	179	T5040	166	T5206	294	T5431.O	141	T7012	190
T3203	179	T5041.Z	174	T5207	294	T5431.T	141	T7045.Z	190
T3204	179	T5042	166	T5208	294	T5501	156	T7050.R	188
T3205	179	T5043	166	T5210	294	T5502	156	T7050.T	188
T4002	275	T5044	166	T5222	294	T5506	154	T7051	188
T4002.Z	275	T5045	167	T5223	294	T5507	156	T7053.G	188
T4003	275	T5046	167	T5225	286	T5508	156	T7053.T	188
T4003.R	275	T5047	167	T5226	294	T5509	118/156	T7053.Z	188
T4005	200	T5048	167	T5228	191/294	T5510	118/156	T7054	188
T4006	200	T5051	165	T5229	294	T5601	164	T7056.N	190
T4007	200	T5052.C	86/112	T5230	294	T5602	164	T7056.R	190
T4200	176	T5052.P	86/112	T5234	294	T5603	164	T7056.T	190
T4201	176	T5056	86/112/156	T5235	294	T5604	167	T7056.Z	190
T4202	176	T5057	166	T5237	286	T5605	164	T7057	190
T4203	176	T5058	166	T5238	286	T5606	164	T7058.F	190
T4204	176	T5059	166	T5239	286	T5607	164	T7058.T	190
T4205	176	T5060	164	T5240	286	T5608	165	T7060.F	188
T4206	176	T5063	169	T5246	292	T6000.G	270	T7060.G	188
T4209	176	T5064	156	T5252	192	T6002	270	T7061	188
T4212	176	T5065	156	T5253	197	T6004	191	T7066	188
T4214	176	T5066	165	T5254	197	T6005	191	T7068	190
T4215	176	T5071	165	T5255	196	T6007.OA	191	T8007	30
T5000.2	170	T5072	165	T5256	196	T6007.OB	191	T8016	56
T5000.Y2	170	T5074	169	T5258	193	T6007.OC	191	T8016.Z	56
T5000.Z2	170	T5075	169	T5259	193	T6007.OD	191	T8018.Z	296
T5002	86/112	T5076	191	T5260	193	T6010.P	270	T8019	46
T5004	167	T5077	166	T5261	194	T6112	191	T8019.Z	46
T5005	168	T5080	160	T5262	194	T6200	275	T8020	46
T5006	168	T5081	160	T5264	194	T6201	275	T8020.Z	46
T5007N	170	T5083	160	T5266	196	T6204	275	T8034	296
T5011	169	T5084	160	T5267	195	T6205	275	T8035	296
T5012.T	154	T5085	160	T5268	194	T6304.2	272	T8036	41
T5013.I	168	T5086	164	T5269	195	T6304.C100	274	T8060	88/114
T5013.M	168	T5088	164	T5270	195	T6309.T2	273	T8061	88/114
T5013.T	168	T5090	154	T5271	195	T6324.T	273	T8062	88/114
T5014.I	168	T5091	154	T5272	194	T6334	273	T8063	88/114
T5014.M	168	T5092	154	T5274	295	T6335	272	T8100	28
T5014.T	168	T5094	164	T5300	193	T6337	273	T8101	29
T5015.I2	168	T5095.N	174	T5301	193	T6337.C80	274	T8102	39
T5015.M2	168	T5095.Y	174	T5302	193	T6339	272	T8103	39
T5015.T2	168	T5095.Z	174	T5401	169	T6341.TG	272	T8104	29
T5017	174	T5096.N	174	T5408	169	T6342	272	T8105	40
T5018	174	T5096.Z	174	T5409	170	T6343	272	T8106	40
T5019	174	T5098	175	T5416	191	T6344	272	T8107	41
T5020	167	T5099	175	T5417	191	T6344.CB150	274	T8108	41
T5021	167	T5101	175	T5420	140	T6345	272	T8109	29/103
T5022	167	T5102	175	T5422	140	T6346	272	T8110	28
T5023	167	T5103	175	T5423	140	T6347	272	T8111	30
T5024	86/112/118	T5104	175	T5424	140	T6402	274	T8112	30

Art.	pag.	Art.	pag.	Art.	pag.	Art.	pag.	Art.	pag.
T8113	30	T8166	33	T8209	57	T8274	65	T8446	28
T8115	30	T8166.Z	33	T8210	57	T8275	65	T8447	38
T8116.Y	296	T8167	39	T8211	66	T8276	65	T8448	38
T8116.Z	65	T8168	39	T8212	66	T8320	67/103	T8450	50
T8117	65	T8169	39	T8213	58	T8321	67	T8451	50
T8118	40	T8170	44	T8214	58	T8322	67	T8452	50
T8119	39	T8171	30	T8215	63	T8323	67	T8453	50
T8120	36	T8173	41	T8216	62	T8324	67	T8454	50
T8121	36	T8175	28	T8218	170	T8330	296	T8455	50
T8122	40	T8176	30	T8219	62	T8335	296	T8456	50
T8124	36	T8177	41	T8220	58	T8344	70	T8457	50
T8126	38	T8178	42	T8221	58	T8345	70	T8500	26
T8128	40	T8179	28	T8222	63	T8346	70	T8501	26
T8129	40	T8180	38	T8223	62	T8347	70	T8502	26
T8130	37	T8181	28	T8224	58	T8401	43	T8503	26
T8131	37	T8181.Z	60/103	T8225	66	T8402	43	T8504	24
T8132	37	T8182	28	T8226	57	T8403	43	T8505	24
T8133	37	T8183	28	T8227	57	T8404	43	T8506	25
T8134	36	T8184	30	T8228	59	T8415	56	T8508	24
T8135	34	T8185	32	T8230	20	T8415.Z	56	T8509	26
T8136	34	T8185.Z	32	T8231	20	T8416	56	T8510	26
T8137	34	T8186	32	T8232	20	T8416.Z	56	T8511	25
T8138	41/86/112	T8186.Z	32	T8234	20	T8417	56	T8513	25
T8140	43	T8187	32	T8236	20	T8417.Z	56	T8515.G	22
T8141	43	T8187.Z	32	T8237	20	T8418	56	T8515.I	22
T8142	34	T8188	32	T8240	66	T8420	55	T8515.T	22
T8143	34	T8188.Z	32	T8241	66	T8421	55	T8516	22/287
T8144	34	T8189	32	T8242	66	T8422	55	T8517	22/287
T8145	44	T8189.Z	32	T8243	66	T8423	55	T8521.Y	47
T8146	44	T8190	32	T8250	64	T8424	55	T8522.Y	47
T8147	42	T8190.Z	32	T8251	64	T8425	55	T8523.Z	62
T8148	42	T8191	32	T8253	64	T8428	38	T8524.Y	47
T8149	44	T8191.Z	32	T8254	64	T8430	54	T8525.Y	47
T8150	42	T8192	32	T8255	64	T8431	54	T8526.Q	16
T8151	43	T8192.Z	32	T8256	62	T8432	54	T8526.Y	16
T8153	42	T8193	32	T8257	62	T8433	54	T8526.Z	16
T8154	46	T8193.Z	32	T8258	58	T8434	54	T8527.Q	16
T8154.L	46	T8194	32	T8260	60	T8435	44	T8527.Y	16
T8155	29	T8194.Z	32	T8261	60	T8436	44	T8527.Z	16
T8156	29	T8195	31	T8262	60	T8437	55	T8531	25
T8157	34	T8195.T	31	T8263	60	T8438	44	T8533	26
T8158	34	T8195.Z	31	T8264	61	T8439	44	T8534	26
T8159	36	T8196	31	T8265	61	T8440	48	T8550	69
T8161	38	T8201	58	T8266	61	T8440.Z	48	T8551	69
T8162	36	T8202	63	T8267	61	T8441	48	T8552	68
T8163	33	T8203	63	T8268	61	T8441.Z	48	T8553	68
T8163.Z	33	T8204	57	T8269	60	T8442	48	T8554	68
T8164	33	T8205	58	T8270	63	T8442.Z	48	T8555	68
T8164.Z	33	T8206	58	T8271	61	T8443	49	T8556	68
T8165	33	T8207	58	T8272	61	T8444	49	T8557	69
T8165.Z	33	T8208	63	T8273	61	T8445	49	T8558	69

Art.	pag.	Art.	pag.	Art.	pag.	Art.	pag.	Art.	pag.
T8607	296	T8661	15	U0008	122	W3337	276	W4303.Y	284
T8609	296	T8662	15	U0009	122	W3338	276	W4330.Y	289
T8620	21	T8663	15	W1011	278	W3339	276	W4330.Z	289
T8621	21	T8664	14	W1012	278	W3340	276	W4331.Z	289
T8622	21	T8665	14	W1013	278	W3341	276	W4332	289
T8623	21	T8666	14	W1014	278	W3342	276	W4401.2	283
T8630	18	T8667	15	W1015	278	W4102	285	W4502	284
T8631	18	T8668	15	W2003.F	282	W4105	285	W4504.Y	284
T8632	18	T8669	14	W2003.Q	282	W4106	279	W4603	278
T8633	18	T8670	14	W2003.T	282	W4110	279	W4702	288
T8634	18	T8671	14	W2003.Y	282	W4113	278	W4706	288
T8635	18	T8680	13	W2006	283	W4117	278	W4707	288
T8636	18	T8681	13	W2007.F	282	W4230.2CB	280	W4708	288
T8640	17	T8682	13	W2007.I	282	W4230.CB	280	W4709.Z	288
T8641	17	T8683	13	W2007.T	282	W4231.CB	280	W4711	288
T8642	17	T8684	12	W2008.Y	282	W4232.CB	280	W5002	279
T8643	17	T8685	12	W2010	278	W4232.I	280	W5101	284
T8644	17	T8686	12	W2012	278	W4233.CB	281	W5102	290
T8645	17	T8687	13	W2015	278	W4234.CB	281	W5103	290
T8646	17	T8688	13	W3007	278	W4235.CB	280	W5104	290
T8650	19	T8689	12	W3008	278	W4236	281	W5200	276
T8651	19	T8690	12	W3330	276	W4237	280	W5201	284
T8652	19	T8691	12	W3331	276	W4238.CB	280	W5203	276
T8653	19	T9005	297	W3332	276	W4239	280	W7001	283
T8654	19	U0004.G	122	W3333	276	W4240.CB	280		
T8655	19	U0005.E	122	W3334	276	W4241.CB	281		
T8656	19	U0005.G	122	W3335	276	W4301	284		
T8660	15	U0006	122	W3336	276	W4302.Y	284		

"Goccia dopo Goccia"

(drop by drop)

Qualcuno ci ha descritto come "una pioggerellina di primavera", che non fa danni, ma con le sue goccioline porta la vita, dà sollievo alla terra arsa dal sole e dà ancora speranza alle piante che avevano sete. Così vorremo fare noi: ridare speranza, gioia e voglia di vivere a tante persone in difficoltà che si trovano in zone svantaggiate del pianeta, come quelle al confine tra Myanmar e Thailandia per esempio, che ancora oggi accoglie centinaia di migliaia di persone che fuggono in condizioni disperate, e poi gli abbandonati, gli "ultimi" nascosti nei tuguri delle grandi metropoli asiatiche: quella gente è la nostra gente. Certo, "i bambini di strada" di Saigon, rappresentano per noi un impegno costante, come anche gli anziani, i disabili e coloro che non hanno più nulla e nessuno al mondo. 'Goccia dopo Goccia' vorrebbe essere sempre accanto a loro.

Queste persone sono lo scopo della nostra vita e vorremmo potervi far vedere gli occhi di quella anziana di Saigon che raccoglieva la spazzatura in strada, a cui abbiamo donato il corrispettivo di un'intera giornata di lavoro: erano occhi pieni di sorpresa, gratitudine ma soprattutto belli perché avevano ritrovato la gioia di vivere e la speranza, non li dimenticheremo mai, anzi, vorremo vederli sul volto di ogni persona a cui ci avviciniamo.

Un immenso grazie a tutti voi a nome della "nostra gente" che da oggi diventerà anche la vostra gente.



Someone described us as a "spring drizzle" that doesn't do any harm, but at the same time with its small little drops it creates life; it eases the soil burned by the sun and it gives hope to those plants who are in need of water. This is exactly what we would like to do: give hope, joy and zest for life to those people who are struggling and find themselves in disadvantaged countries, such as the ones on the borders between Myanmar and Thailand. These countries still welcome hundreds of thousands of people who run away from very hard conditions and the abandoned ones, those who "don't matter" who live in the shacks of big Asian cities. They also welcome the "street children" of Saigon, the elders, the physically and mentally challenged and those who have nothing and no one else in the world. This is our people. "Goccia dopo Goccia" would like to stand by them because these people are our job and daily life purpose. We would like to show you the eyes of the elderly woman who was collecting trash from the streets in Saigon and to whom we donated the equivalent of a one day workpay: her eyes were full of surprise, gratitude and were most of all, magnificent because they found the hope and the joy to live again. We will never forget those eyes and we would like to see them on the face of every person we meet. A big and warm thank you to all of you from "our people" who, starting from today, will become "your people".



www.gocciadopogoccia.ch

shop on line 24/24h



LEONE srl

Via della Dogana 25 - 48022 Lugo (RA) Italy

Tel. +39 0545 24262

Fax +39 0545 34505

info@leonedecorazioni.com

export@leonehoreca.com (export dpt.)

leonehoreca.com

Visitate il nostro sito e-commerce
leonedecorazioni.com

potrete acquistare **24 ore su 24** con un semplice "click". Troverete sempre tantissime novità e occasioni speciali nella nuova sezione OUTLET, con sconti fino al 50%!

migliaia di prodotti sempre disponibili

Leone dispone di un'ampia gamma di prodotti disponibili a magazzino permettendovi di ottimizzare i vostri acquisti in linea con le vostre esigenze. Potrete scegliere i prodotti giusti per voi tra tantissimi articoli esclusivi ed originali che vi permetteranno di esprimere al meglio lo stile che più vi piace.

garanzia soddisfatti o rimborsati

Leone vi dà la possibilità di restituire la merce acquistata entro 30 giorni dal ricevimento purché integra e custodita all'interno dell'imballo originale.

seguici su:



Leone Horeca



@leonedecorazioni



@leonehoreca

condizioni di vendita

Prezzi - I prezzi esposti sono esclusi di IVA legalmente in vigore al momento della fatturazione.

Consegna - Tramite Corriere Espresso.

Fatturazione - Ad ogni spedizione sarà allegata regolare fattura accompagnatoria. Nel vostro interesse vi preghiamo di indicarci gli esatti dati fiscali necessari a tal fine.

Pagamento - Contrassegno al ricevimento della merce ordinata.

Garanzia Leone - Gli articoli che non risultassero di pieno gradimento del cliente possono essere restituiti nella loro confezione originale ed integra, purché entro 30 giorni dal ricevimento del pacco, e saranno integralmente rimborsati. Eventuali omaggi promozionali resteranno invece di esclusiva proprietà del cliente.

Tutela Marchio e Articoli - Tutela © Copyright. Gli articoli del presente catalogo contrassegnati dal © Copyright, sono tutelati dalle leggi n. 633 del 22.04.1941, e n. 1845 del 14.12.1942 sui diritti d'autore; di essi è quindi vietata ogni riproduzione, totale o anche parziale, non autorizzata.

Tutela Foto - Le foto presenti nel catalogo e sul sito internet www.leonedecorazioni.com sono coperte da © Copyright.

Foro Competente - Il foro competente per ogni controversia è quello di Ravenna.

Attenzione: Vi ricordiamo che i prodotti presenti in questo catalogo sono conformi alle leggi in vigore. Vedi specifiche di conformità riportate a pagina 7.



Leone s.r.l.
via della Dogana, 25 - 48022 Lugo (RA) Italy
Tel. 0545 24262 - Fax 0545 34505
info@leonedecorazioni.com
www.leonedecorazioni.com